

Date 11-19-77

Mark opposite each item the number of the serial or serials in which the information appears. Although these items are regarded as nonvariable, changes may be noted by adding the new serial number and crossing out the old. When form is complete as to all applicable items, the Agent and Field Supervisor should initial the form at the end.

Symbol Number 155-RE Office File 171-256

Type of Informant: Prob Regular Ghetto CS Bureau File 157-177

	Serial Number
1. Name	
2. Aliases	<u>157-1643-24</u>
3. Symbol Number assigned and Bureau advised	<u>157-1643-24</u>
4. Cover name assigned and Bureau advised	
5. Background developed	
6. Personal history, as required in Sec. 130D, 2c, Vol. IV, M. of I.	
7. Description	
8. Photograph	<u>In 157 file</u>
9. Credit check	<u>1/6/77</u>
10. Local criminal check	<u>1/6/77</u>
11. Bureau Identification Record (FD-9)	<u>157-1643-6</u>
12. Selective Service check	
13. Armed Service record check	
14. Informants canvassed	
15. Past racial activities	
16. Racial associates	<u>None</u>
17. Informant advised of:	
(a) Not Bureau employee	<u>157-1643-24</u>
(b) Activities voluntary	<u>132-1643-14</u>
(c) Relationship confidential	<u>137-1643-24</u>
(d) FBI jurisdiction	<u>137-1643-24</u>
(e) Furnish information only to Bureau	<u>137-1643-24</u>
(f) Payments are income	<u>132-1643-24</u>
(g) Report to be submitted under code name and in third person	<u>137-1643-24</u>
(h) Not to contact office personally	<u>137-1643-24</u>
(i) Not to retain copies of notes or reports	<u>137-1643-24</u>
18. Reliability check	
19. Statement of cooperation	
20. When removed from probation	<u>11/11/75</u>
21. Informant indices card made	<u>2/19/77</u>
22. Agent who handles informant	<u>J. COS</u>
23. Alternate Agent	<u>15</u>
24. Flash notice placed <u>157-1643-21</u> or removed	
25. Coverage	
Completed	
Approved	

Keep on Top of Other Serials in File.

Handwritten notes: 11/2/75, 11/11/75, FD-377, w.

Date p

11/28/72

Date received

11/28/72

Received from (name or symbol number)

INFORMANT

Received by

J. [Signature]

Method of delivery (check appropriate blocks)

in person by telephone by mail orally recording device written by Informant

If orally furnished and reduced to writing by Agent:

Date

Dictated _____ to _____

Transcribed _____

Authenticated by Informant _____

Date of Report

11/28/72

Date(s) of activity

11/20/72

Brief description of activity or material

Mtg of Los Angeles Citizens Committee

File where original is located if not attached

170-16314-169

* INDIVIDUALS DESIGNATED BY AN ASTERISK (*) ONLY ATTENDED A MEETING AND DID NOT ACTIVELY PARTICIPATE IN VIOLENCE OR REVOLUTIONARY ACTIVITIES WERE NOT DISCUSSED.

*NOT GERMANE
TO*

157-

(HOWARD BERRY GODFREY)

Godfrey

(14) DMB Read by WJ

170-286-157

SEARCHED INDEXED
SERIALIZED FILED
AUG 2 1974
FBI - SAN DIEGO

SEARCHED INDEXED
SERIALIZED FILED
AUG 9 1972
FBI - LOS ANGELES

20 November 1972

It has been learned that Jack L. Du Long attended a meeting of the Greater Los Angeles Area Citizens Councils held on this date in the Sparton Room of the Olympian Motor Hotel at 1903 West Olympic Blvd. in Los Angeles California. The meeting was set for 8pm and did start within a few minutes of 8pm. A total of 19 or 20 people were on hand for the meeting. Roderic Duff conducted the meeting. He is the GLAACC leader. He announced that this was the first GLAACC meeting in a year and a half. He indicated that GLAACC had interested itself with local issues during this time. He outlined work in monrovia involving the schools and a local election. Duff stated he planned an important meeting in two months, in late January 1973. He did not state why there would be another meeting so soon after this gathering. It would be unusual in view of the fact that this meeting was the first in eighteen months. Duff discussed the "blood program" that was mentioned in their mail out report of last week in which GLAACC members would donate blood to other GLAACC members only when needed and then direct from donor to donor. in brief the plan is to prevent a GLAACC member from receiving blood from a black. It appears the meeting was called only to hear two speakers. First to speak was a man believed to be named Rick Norton

informant

Page Two

20 November 1972

NOT GERMANE

TO

Godfrey

About 8:30pm a Mr. Calvin Fox of El Cajon, California began to address the gathering. This man states

INFORMANT

Page Three

20 November 1972

he operates a Gulf station in El Cajon. Fox appears to be in his early 40s, about 5:9 and 170lbs. Fox spoke for over an hour regarding his involvement in the Secret Army Organization in the San Diego area. Fox related how Howard Berry Godfrey started to stop by his station early in 1972. Fox charges that Godfrey tried many times to get him to join the SAO but that he never joined the group. Fox admits he kept some of the literature around the station that Godfrey would leave for him. Fox stated that in mid May he and his wife decided to join the Rev mcIntyre and his "Victory march in Washington". Fox charges the FBI then raided his station while he was gone and broke into a file cabinet and then planted material in the cabinet. Fox hints that the FBI claims to have feared that he went east to do harm to A. Bremer after the latter shot Gov. G. C. Wallace in Maryland. Fox then related how he appeared as a witness for William Yakopec in September 1972 and how this has led to his trial on Tuesday 5 December 1972 for perjury. Fox asked all who could to be on hand in December for his trial. Roderic Duff stated he and several other GLAACC members would be present for the trial. Fox stated his legal costs were very high and a collection was taken for him. It was noted that Jack Du Long gave fox \$5. and it appeared about \$30 to \$40 may have been given to Fox this evening by the GLAACC members. The meeting ended shortly before 10pm. Among the twenty people present and known to this observer were: Roderic Duff, Jack Du Long,

INFORMANT

Page Four

20 November 1972

Larry Nazimek, Hale McGee, Joe Weber, Stan Wade,
Glen Wheeler. Others present appear to be long
term GLAACC members.

INFORMANT

(Mount Clipping in Space Below)

— FBI behind right-wing "army"? —

Militants here say they were spying victims

(Indicate page, name of newspaper, city and state.)

La Jolla - University
Sentinel
Wed 1/15/75

(First of two parts)

by Lynne Carrier

Three years ago, a small band of militant right-wingers calling itself the "Secret Army Organization" declared war on communism.

From its headquarters in El Cajon, the paramilitary group dedicated itself to combatting anti-war protesters and "leftists."

Est a \$10.6 million civil rights damage suit filed in behalf of two San Diego militants charges the SAO wasn't acting entirely on its own.

The suit, handled by the American Civil Liberties Union (ACLU), contends the organization during its eight months of extremist activities.

Peter Bohmer, former assistant economics professor at San Diego State

University, and co-plaintiff Paula Tharp say that because of their leftist political beliefs they were the target of bodily and professional injury, acts of terrorism and harassment by right-wingers led by a paid-FBI informer.

They also claim law enforcement officials failed to protect them and on occasion harassed the plaintiffs.

Although the incidents happened in San Diego, Bohmer and Tharp maintain their woes stemmed from ex-President Nixon's domestic counterintelligence policies of the late '60s and early '70s.

To prove that, the suit names 58 defendants, ranging from Nixon to the cop on the beat.

The list includes a galaxy of Watergate villains — John Mitchell, H. R. Haldeman, John Erlichman, Charles

CC # 62-2248 (SUIT)
& 157-2815 (SAO)

190-286-160

SEARCHED	INDEXED
SERIALIZED	FILED
FEB 11 1975	
FBI - SAN DIEGO	

mentioned are officials, White House staff members and present and past CIA chiefs.

"So far as we know, this is the first case implicating the CIA since it was alleged to have conducted domestic surveillance of anti-war protesters," said Bohmer.

County Supervisor Lou Conde, Dist. Atty. Ed Miller, Police Chief Ray Hoobler and other policemen also made the defendants' list.

Commenting on the number of defendants named, Logan McKechnie, spokesman for the district attorney's office, noted, "It's totally unwieldy. How will they ever get the case to court?"

McKechnie questioned whether the

could be proven.

Among numerous allegations in the suit, Bohmer and Miss Tharp are charging:

—The FBI funneled money into the SAO with full knowledge the members were violence-prone and committed to disrupting and harassing anyone it labeled as "Communist."

—After several death threats against Bohmer, Miss Tharp was shot in the elbow by an SAO gunman firing into Bohmer's house.

—FBI agent Steve Christiansen kept the weapon used to shoot Miss Tharp in his home for six months before revealing the FBI knew the identity of the gunman.

—Despite their requests for
(See SECRET ARMY, 4A)

~~Secret army~~

(Continued from 1A)

protection, the plaintiffs claim police never took much interest until an SAO member bombed the X-rated Guild Theater while a policeman and a city official were seated in the audience.

—The FBI informant, Howard Barry Godfrey, admitted in court he recruited SAO members and acted as leader of the sole operative SAO unit in the county.

—In early 1972, when the Republican convention was still scheduled for San Diego, "dirty tricks" specialist Donald Segretti asked San Diegans to infiltrate the Convention Coalition, a "new left" group.

—Segretti also met with Godfrey and other SAO members at the Gunsmoke Ranch in El Cajon.

—Conde supplied equipment and money to the SAO and its predecessor, the Minutemen, between 1967-72.

—While a paid informant in the Minutemen, Godfrey and his cohorts broke into the offices of an underground

newspaper, the Street Journal, and destroyed equipment and subscription records.

Bohmer further complained of his arrest and conviction in 1972, stemming from charges related to his role in a protest demonstration during which protesters threw ties on a railroad track. He said police hired Wayne McCracken, an informer, to infiltrate his committee.

Godfrey was forced to spill the beans when Rubien Brandon, a police detective, and Hoobler pressured the FBI to identify its FBI informer after the theater bombing.

The informant's testimony put two SAO members — William Francis Yakopec and George Hoover — behind bars.

Yakopec was convicted of bombing the Guild Theater and got a six months to life sentence.

Hoover, whose conviction was recently upheld by the State Supreme Court, is serving five years to life for shooting into Bohmer's house and wounding Miss Tharp.

Other alleged SAO members were charged with offenses ranging from firearm and explosive violations to perjury for denying membership in the paramilitary group. The SAO, whose ranks apparently never totaled more than 30, disintegrated.

His cover blown, Godfrey folded his tent and moved to Sacramento where he is now employed by the fire department there. His FBI contact, Steve Christiansen, left the agency when Godfrey went public with the SAO story. He is presently a store manager in Kenosh, Utah.

On one point, leftists and SAO defendants agree — the full story hasn't been told.

According to Frederick Hetter of San Ysidro, who was the attorney for Yakopec and SAO state coordinator Jerry Lynn Davis, the FBI apparently limited its agents' responses to carefully screened written questions.

He said the FBI invoked "executive privilege" on the grounds federal agents aren't supposed to testify in state trials.

Hetter, who said his SAO clients may have been unwitting pawns of Godfrey and the FBI, claimed he was unable to get hold of FBI documents crucial to Yakopec's defense.

"We just couldn't get our hands on the stuff," he said. "And that information was the heart of our defense."

Rex Schroeder, head of the FBI office here, said the FBI did cooperate during the SAO trials, adding. "There's never enough information for defense attorneys."

Schroeder said he hasn't reviewed the Bohmer-Tharp lawsuit yet.

As for Bohmer and ACLU lawyer, Rosenbaum, they admit the FBI role in the SAO may give SAO defendants grounds for filing their own civil rights suit. But, generally, they weren't sympathetic towards their ideological adversaries.

Bohmer wryly noted that on one score he did end up on the same side of the fence with the SAO:

(Next: The FBI and the SAO.)

(Mount Clipping in Space Below)

FBI informant's role challenged

Lawsuit fingers

the spy next door

(Indicate page, name of newspaper, city and state.)

La Jolla - University
Sentinel
1/19/75

by Lynne Carrier

(Second of two parts)

He is soft-spoken, bespectacled — the kind of man you wouldn't pick out of a crowd.

He was an elder in the Mormon church and held a good job with the Fire Department.

But Howard Barry Godfrey had another identity: he was a spy for the FBI.

And when he came in from the cold 2½ years ago, he told a bizarre tale of

extremist intrigue fit for a Le Carre novel.

Godfrey was an FBI informer in a right-wing organization called the Secret Army Organization (SAO) headquartered in El Cajon.

During a series of trials in September, 1972, his testimony smashed the small paramilitary unit, sending two members to prison and bringing others to trial on a variety of firearms, explosives and perjury charges.

As the star witness for the prosecution, he recounted an SAO history studded with

bombings, shooting and harassment of leftist dissenters and war protesters.

Godfrey was no mere SAO fellow traveler. He headed the only active cell in the county and took part in its hijinks.

There was speculation Godfrey was more an agent provocateur than an informant and that the FBI may have condoned — even encouraged — dirty tricks against radicals.

On that premise, the American Civil Liberties Union (ACLU) has filed a \$10.6 million damage suit in behalf of two local militants. Peter Bohmer and Paula Tharp.

Edition:

Author:

Editor:

Title:

Character:

Classification:

Submitting Office:

Being Investigated

targets of SAO shenanigans.

Ironically, the suit incriminates Godfrey with his own words. He is one of 53 defendants named in the complaint. And much of its 40-page text is based on his court testimony and press interviews.

The ex-informant — now employed at the state fire marshal's headquarters in Sacramento — refused to comment on the ACLU suit.

However, his portrait of domestic espionage and SAO tactics is on the public record.

(See THE SPY, 4A)

The spy next door

(Continued from 1A)

His history as an FBI infiltrator of the extreme right began in 1967, he said. When first contacted by members of an earlier paramilitary group, the Minutemen, Godfrey said the stake president of his Mormon church put him in touch with the BFI.

Godfrey came aboard as a paid FBI informant, spying and participating in Minutemen activities.

Largely due to former U.S. Atty. Gen. Ramsey Clark's efforts, the FBI cracked down on Minutemen groups all over the country in the late '60s.

The San Diego chapter declined after its local leader, Troy Houghton, vanished mysteriously in 1967.

In October 1971, Godfrey told his FBI contact, Steve Christiansen, a phoenix was rising from the Minutemen ashes — the Secret Army Organization. Christiansen was interested — and Godfrey was back in the informer business.

Every bit as virulent and fanatical as the Minutemen, SAO members were committed to armed resistance of leftist "enemies." Units were active in 11 western states, with San Diego sporting an especially dedicated, if small, group of activists.

Godfrey fingered Jerry Lynn Davis (also known as Capt. Patrick McDonald) as state SAO commander and local coordinator.

Godfrey recruited members making great pretense of concealing their identities. He testified he had nine men in his cell. There was also a 10th man unknown to the other members. It was a dummy number, explained Godfrey, so he could slip an extra set of SAO literature into the FBI files.

Depending on how much information Godfrey supplied, the FBI paid him up to \$250 a month.

Additionally, the FBI reimbursed him for his monthly dues and occasional cash donations to the group.

On learning the FBI had funneled money into the SAO, Jerry Davis commented acidly, "You might say we were a federally funded poverty program of the right."

According to both leftists and lawyers who later defended SAO members, Godfrey had the best of both worlds — he could indulge in paramilitary fun and games while pocketing government money.

Godfrey assisted his SAO subordinates in spreading hate literature attacking leftist sympathizers and pornography. Members of his cell also committed a series of capers that, in two cases, nearly ended in tragedy.

With students organizing protests against the Vietnam War, young radical demonstrators figured near the top of the SAO "enemies" list.

In one interview, Godfrey allegedly claimed the SAO accumulated vast files on local leftists, sometimes by breaking into their homes. Godfrey passed this information on to the FBI.

In late 1971, Peter Bohmer — a former economics instructor at San Diego State and an active war critic — began receiving death threats from the SAO.

An SAO bulletin berating Bohmer listed his address, phone number and description, inviting readers to "stop by and deal with the Red scum."

On another occasion, an anonymous caller left Bohmer a message: "Wish Pete a Merry Christmas. This will be his last. This is the Secret Army Organization."

Other death threats followed.

Finally, on Jan. 6, 1972, two shots were fired through Bohmer's window. His friend, Paula Tharp was wounded in the elbow.

As a result, police began to investigate the SAO.

But the FBI wasn't ready to blow Godfrey's cover.

Six months later, Godfrey admitted he had witnessed the shooting. He told a court he had driven to Bohmer's house in Ocean Beach on a "surveillance" mission. Another SAO member, George M. Hoover, had fired two shots from Godfrey's car and would have fired more if his gun hadn't jammed, said the informant.

Godfrey had then taken the tell-tale pistol and Hoover's jacket to FBI agent Christiansen, who hid the evidence in his home until the SAO was exposed later that year.

The final straw that broke the SAO was the wildcat bombing of the Guild Theater on June 19, 1972. No one was injured in the blast, but Rubien Brandon, a detective on the San Diego police force, and Thorpe Nolan of the city attorney's office, were in the audience apparently reviewing porno films for possible obscenity violations.

After Brandon and Police Chief Ray Hoobler pressured the FBI to reveal its informer's identity, Godfrey soon ascended the witness stand and nailed Davis and other SAO members.

Hoover was charged with shooting into Bohmer's house and Godfrey's neighbor, William Francis Yakopec, was cited as the Guild Theater bomber.

According to Godfrey, Yakopec had long toyed with the idea of blowing up porno theaters, adult book stores and massage parlors.

The informer told how Yakopec met him at the fence between their yards, still flushed from his bombing exploit of the previous night.

Godfrey testified Yakopec described " ... the sound, the blast, how the dust hung over the air at the theater ... how he stood down at the end of the block and listened to the blast. He then described to me how he placed the bomb, what type of a bomb he used, and how he carried it down the alley and planted it."

Frederick Hetter, Yakopec's attorney, believed his client might have had grounds for pleading entrapment but the jury found Yakopec guilty anyway.

Godfrey's friendship with the unemployed carpenter began in a gun shop. Soon after, Godfrey encouraged Yakopec to move next door to his El Cajon residence.

Yakopec, a former Minuteman sympathizer, became Godfrey's lieutenant in the SAO. Together, they discussed their mutual hate of pornography and communism and explored their common loves — guns and explosives.

It was Godfrey who sold Yakopec the explosives he used to bomb the Guild Theater. Godfrey said he reported the transaction to the FBI.

But Godfrey maintained he advised his lieutenant "he should bury them and save them for after the Communist takeover."

Deputy Dist. Atty. Richard Huffman, who prosecuted the Yakopec case, said there may be other SAO information in the FBI files. But he criticized the ACLU for wanting to "rummage freely through FBI records."

(Mount Clipping in Space Below)

Secret Army Organization: Was FBI behind it?

(Indicate page, name of newspaper, city and state.)

Antiwar protester and leftist dissenters who were the target of the SAO now contend that SAO wasn't acting entirely on its own.

This is the first of two articles on the Secret Army Organization.

By **LYNNE CARRIER**

Three years ago, a small band of gun-toting militant right-wingers calling itself "The Secret Army Organization" (SAO) declared war on communism.

From its local headquarters in El Cajon, the paramilitary group dedicated itself to wreak terrorism on antiwar protesters and leftist dissenters.

But a \$10.6 million civil rights damage suit filed last week in behalf of two local radical activists charges that the SAO wasn't acting entirely on its own.

SUITE COMPLAINT. to be handled by the American Civil Liberties Union (ACLU), contends that, during its eight months of extremist activities, the SAO was organized, and largely funded and directed, by the FBI.

NW 55009 DocId:32989524

Peter Bohmer, former

The men ... maintain their woes stemmed from ex-President Nixon's domestic Counter Intelligence policies.

assistant economics professor at San Diego State University, and co-plaintiff Paula Tharp, say first because of their leftist political beliefs, they were the target of bodily and professional injury, acts of terrorism and harassment by rightwingers led by a paid FBI informer.

They allege that local law enforcement officials failed to protect them from danger and on occasion also harassed the plaintiffs.

Although the incidents happened in San Diego, Bohmer and Tharp maintain their woes stemmed from ex-President Nixon's domestic counter-intelligence policies of the late '60's and early '70's.

To prove that national conspiracy, the suit names 58

Chula Vista Star
NEWS 1/16/75

Date: _____
Edition: _____
Author: _____
Editor: _____
Title: _____

Character: _____
or
Classification: _____
Submitting Office: _____

Being Investigated

170-286-165

SEARCHED _____	INDEXED _____
SERIALIZED _____	FILED _____
JAN 17 1975	
FBI - SAN DIEGO	

...nt includes a galaxy of gate villains — John ...ll, H. R. Haldeman, John ...hman, Charles Colson, ...don Liddy, Donald Segretti ... E. Howard Hunt, among ...ers. ... Also mentioned are FBI administrators and staff, current ...ite House staff members, and ...sent and past CIA chiefs.

“SO FAR as we know, this is the first case implicating the CIA since it was alleged to have conducted domestic surveillance antiwar protesters,” said Bohmer. In San Diego, former SAOs members, Supervisor Lou Conde, District Attorney, Ed Miller, Police Chief Raymond Hoobler, and other law officers made the defendants’ list. Commenting on the number of defendants named, Logan McKechnie, spokesman for the district attorney’s office, noted, “It’s totally unwieldy. How will

any ever get the case to court?” McKechnie questioned whether the charges outlined in the 40-page suit could be proven. However, Mark Rosenbaum, a lawyer handling the case from the Los Angeles ACLU office, countered that “we didn’t include any charge that we felt we couldn’t prove in a court of law.”

ROSENBAUM, who is also handling a civil rights suit for actress Jane Fonda, added that the Bohmer-Tharp lawsuit is important because it should “expose the underbelly of Watergate” and pressure the government to reveal what went

on at the grassroots before the Watergate scandal broke. “Everyone has to stop and think before he engages in these activities,” said Rosenbaum of law enforcement agents who may have violated the civil rights of leftists opposing the IndoChina War and Nixon’s governmental policies.

AMONG numerous

allegations in the suit, Bohmer and Miss Tharp are charging. — The FBI funnelled money into the extremist SAO with full knowledge the members were violence-prone and committed to disrupting and harassing anyone it labeled a Communist.

— After several death threats against Bohmer, Miss Tharp was shot in the elbow by an SAO

gunman, firing into Bohmer’s house.

FBI agent Steve Christiansen kept the weapon used in shooting Miss Tharp concealed in his home for six months before revealing the FBI knew the identity of the gunman.

— Despite their requests for protection from the SAO, the plaintiffs claim the San Diego

police force never took much interest until an SAO member bombed the x-rated Guild Theater while a police officer and a city official were seated in the audience.

— The FBI’s informant in the SAO, Howard Barry Godfrey, was an agent provocateur, who admitted in court testimony he had recruited SAO members and acted as leader of the sole operative SAO unit in the county.

— In early 1972, when the Republican Convention was still scheduled for San Diego, “dirty tricks” specialist Donald Segretti asked two San Diegans to infiltrate the San Diego Convention Coalition, a “new left” group of government and war critics.

— Segretti also met with Godfrey and other SAO members at the Gunsmoke Ranch in El Cajon.

— County Supervisor Conde supplied equipment and money to the SAO and its predecessor, the Minutemen, between 1967 and 1972.

— While a paid informant in the Minutemen, Godfrey and his cohorts broke into the offices of

So far as we know, this is the first case implicating the CIA since it was alleged to have conducted surveillance

an underground newspaper, the Street Journal and destroyed equipment and subscription records.

— Disillusioned with Nixon’s trip to China, the SAO contemplated assassinating the President by flying a drone into his plane when it arrived at the Republican Convention in 1972.

— The SAO also considered kidnapping or killing leftist leaders during the convention and spraying protesters on Fiesta Island with white phosphorus.

— Bohmer further complained of his arrest and conviction in 1972, stemming from charges related to his role in a protest demonstration during which protesters threw ties on a railroad track. He said San Diego police hired Wayne McCracken, an informer, to infiltrate his defense committee.

MUCH OF the information on SAO activities cited in the suit was based on sworn courtroom testimony supplied by one man — FBI informant Godfrey.

Prior to Godfrey's sensational revelations during a series of SAO trials in 1972, the Secret Army lived up to its name. It was known mainly by its literature, posters and emblems, but its members steered clear of personal publicity. A few people even doubted the group existed.

Godfrey was forced to spill the beans when Rubien Brandon, a detective in the San Diego police department's investigative support unit, and police chief Raymond Hoobler pressured the FBI to identify its

FBI informer after the Guild Theater bombing.

The informant's testimony put two SAO members — William Francis Yakopec and George M. Hoover — behind bars for long terms which they are still serving.

Yakopec was convicted of bombing the Guild Theater and got a six months to life sentence.

Hoover, whose conviction was recently upheld by the state Supreme Court, is serving a five year to life sentence for shooting into Bohmer's house, wounding Miss Tharp and illegal possession of a billy club.

OTHER ALLEGED SAO members were charged with offenses ranging from firearm and explosive violations to perjury for denying membership in the paramilitary group. The SAO, whose ranks apparently never totalled more than 20, disintegrated.

His cover blown, Godfrey folded his tent and crept out to Sacramento where he's now with the fire department. His FBI contact, Steve Christiansen, left the agency when Godfrey went public with the SAO story. He's presently a store manager in Kenosh, Utah.

On one point, leftists and SAO defendants agree — the full story hasn't been told.

ACCORDING to Frederick Hetter of San Ysidro, who was the attorney for Yakopec and SAO state coordinator Jerry Lynn Davis, the FBI apparently limited its agents' response to carefully screened written questions.

He said the FBI invoked "executive privilege" on the grounds federal agents aren't supposed to testify in state trials.

Hetter, who said his SAO clients may have been unwitting pawns of Godfrey and the FBI, claimed he failed to get hold of FBI documents crucial to Yakopec's defense.

"We just couldn't get our hands on the stuff," he groaned. "And that information was the heart of our defense."

Rex Schroeder, head of the local FBI office, said he felt the FBI had cooperated during the SAO trials, adding, "There's never enough information for defense attorneys."

Schroeder said he hasn't reviewed the Bohmer-Tharp lawsuit yet.

As for Bohmer and ACLU lawyer Rosenbaum, they admit that the FBI's role in the SAO may give the SAO defendants some grounds for filing their own civil rights suit. But generally, they weren't sympathetic towards their ideological adversaries.

Bohmer wryly noted that, on one score, he did end up on the same side of the fence with an SAO member.

For a time, he and Yakopec were cellmates at Chino.

Next: The FBI and the SAO — Informant Godfrey tells how the relationship worked.



(Mount Clipping in Space Below)

Conviction Upheld In Shooting

The state Supreme Court has upheld the conviction of George Mitchell Hoover, 37, a key figure in a series of trials here in 1972 involving alleged members of the right-wing paramilitary Secret Army Organization.

The Supreme Court ruling, was announced by the office of Dist. Atty. Edwin L. Miller, follows an Oct. 30, 1973, decision by the Fourth District Court of Appeal reversing the conviction of Hoover. The attorney general's office took the case to the Supreme Court.

Hoover, formerly of Santee, was sentenced to five years to life in state prison in January, 1973, following his conviction in Superior Court on charges of assault with a deadly weapon, firing into an occupied dwelling and possession of a billy club.

Hoover appealed the conviction through Appellate Defenders, Inc., questioning the credibility of a key prosecution witness. The witness was Howard Barry Godfrey, a former San Diego fireman who was a paid FBI informant assigned to infiltrate extremist groups.

Hoover contended the Superior Court jury should have been allowed to weigh whether Godfrey was working as a "double agent" with both the FBI and the Secret Army Organization, finally deciding to testify for the state to protect himself.

The charges against Hoover stemmed from the firing of a bullet into the home of Peter Bohmer, then a former assistant professor at San Diego State University, on Jan. 6, 1972. The bullet struck a friend of Bohmer, Paula Tharp, 23, wounding her in the arm. Bohmer resided on Muir Avenue in Ocean Beach at the time.

(Indicate page, name of newspaper, city and state.)

SAN DIEGO JOURNAL
12/6/74

Date:

Edition:

Author:

Editor:

Title:

Character:

or

Classification:

Submitting Office:

Being Investigated

~~157-3017~~
170-286-164

SEARCHED _____ INDEXED _____
SERIALIZED _____ FILED _____
DEC 6 1974 /
FBI-SAN DIEGO

1-157-2815 (SAO)
① 170-286 (Hoffrey)
② 157-3017 (Horn)

Send LHM
2. Return for AOEK

(Mount Clipping in Space Below)

San Diego County Supervisor Admits 'Pranks' on Leftists

BY NARDA Z. TROUT

Times Staff Writer

100-16205-361-1-242-2525

SAN DIEGO—The chairman of the San Diego County Board of Supervisors, who had previously denied allegations that he harassed leftists here, has now admitted "some pranks."

day by CalPIRG (California Public Interest Research Group), a Ralph Nader-type organization here.

The Conde profile shed some further light on an era of harassment and violence against the left documented by the local underground newspaper, The Door, as well as by local law enforcement officials.

Conde was reportedly active in the late 1960s when the Minutemen and its successor, the Secret Army Organization, targeted leftists for firebombings, shootings and harassing phone calls.

Conde, 47, had previously denied his activities in articles in The Door, but he finally admitted the incidents to CalPIRG researchers Chris Bystrom and Alan Friedman after their exhaustive, two-month long investigation.

He denied being a Minutemen member, although he said he was friends with its then recognized West Coast leader, Troy Houghton, and Houghton's wife, Bettie, and at one time gave Houghton a military

Please Turn to Page 4, Col. 1

In a report made public by a research group here, Supervisor Lou Conde said he disrupted a Peace and Freedom Party open house and also attended to a controversial college professor Herbert Marcuse in Effingham.

On both occasions he was accompanied by alleged members of the Minutemen, a now defunct right-wing paramilitary organization that tried on a widespread campaign of violence and harassment against the left movement here in the late 1960s. Last year, in an interview with the Times, Conde denied these activities. They occurred before he was elected to the Board of Supervisors in 1972.

Conde's statements were included in one of 13 profiles on the county's supervisors and eight state legislators which were published Tues-

(Indicate page, name of newspaper, city and state.)

Los Angeles Times
9/19/74

Date:
Edition:
Author:
Editor:
Title:

12

Character: Lou Conde

Classification:

Submitting Office: 170-286-163

Being Investigated

SEARCHED INDEXED
SERIALIZED FILED
SEP 19 1974
FBI-SAN DIEGO

20-cc? Tucson 100-140617
Make copies for:
- 170-286 (Houghton)
- 157-2815 (SAO)
- 157-1798 (Minutemen)
- 100- (Herbert Marcuse)
- 157-1614 (Troy Houghton)
- 157-1813 (Bettie Houghton)

		Date prepared <i>8/8/74</i>
Date received <i>8/5/74</i>	Received from (name or symbol number) <i>INFORMANT</i>	Received by <i>SA Earl M. Betsworth</i>
Method of delivery (check appropriate blocks)		
<input type="checkbox"/> in person <input type="checkbox"/> by telephone <input checked="" type="checkbox"/> by mail <input type="checkbox"/> orally <input type="checkbox"/> recording device <input checked="" type="checkbox"/> written by Informant		
If orally furnished and reduced to writing by Agent:		Date of Report
<u>Date</u> Dictated _____ to _____ Transcribed _____ Authenticated by Informant _____		<i>7/29/74</i>
		Date(s) of activity <i>8/11/74</i>

*NOT GERMANE
TO Godfrey*

170-286-162

SEARCHED	INDEXED
SERIALIZED	FILED
AUG 23 1974	
FBI - SAN DIEGO	

INFORMANT could be identified,
Deleted MATERIAL NOT
germane
TO Godfrey

① 170-286 (Godfrey)

NOT GERMANE

TO Godfrey

1 page

NOT GERMAN

TO Godfrey

INFORMANT

P.S.-Stan McDade claims that Barry Godfrey is back in San Diego.

NOT GERMANE

TO Godfrey

UNITED STATES GOVERNMENT

Memorandum

TO : SAC, SAN DIEGO (170-286)

FROM : SAC, LOS ANGELES (157-8214) (RUC)

SUBJECT: HOWARD BARRY GODFREY
EM - SAO
OO: San Diego

DATE: 7/30/74

UNCLASSIFIED

Enclosed for San Diego is a copy of a Los Angeles County Jail Booking and Property Record pertaining to arrest of LOUIS JACKSON on 7/9/74; also one copy of a letter dated 7/5/73 addressed to BILL RITTER, Editor, "The Door", Post Office Box 2022, San Diego, California, from JERRY BUSCH. Also enclosed is an FD-306 containing information received from LA 6993-E on 11/28/72 which was not previously furnished to San Diego.

On 7/11/74, Officer TOM GREEP, Los Angeles County Sheriff's Office (LACSO), Intelligence Division, advised that LOUIS JACKSON, a Negro, born 1/13/43, in Texas, had been arrested by the LACSO on a traffic warrant charge but released as not being the person named in the warrant. When JACKSON was picked up, he had a jacket, which he said belonged to one ERIC. In the pocket of the jacket was found a letter, a copy of which is enclosed. Officer GREEP said that JACKSON said he knew nothing about the letter. JACKSON advised that ERIC lived in Playa Del Rey in the Los Angeles area. Officer GREEP said he would provide copies of the booking record and letter.

On 7/16/74, a copy of the booking record and letter were received by the Los Angeles Office from Officer GREEP by mail. They are being enclosed. GREEP also sent a note advising that JACKSON's true name was LOUIS TACKWOOD.

San Diego will note that the letter contains, among other matters, extensive information regarding HOWARD BARRY GODFREY.

- 2 - San Diego (Enc. 3) (RM)
- 1 - Los Angeles (Sq. #6)

ANC/met
(3)

*Copy of letter
& info contained herein sent
that re Louis Jackson previously
received. File only. Info*

170-286-160

SEARCHED	INDEXED
SERIALIZED	FILED
AUG 3 1974	
FBI - SAN DIEGO	

DeLoren

LA 157-8214

Los Angeles is taking no further action with reference to the contents of the letter. In view of the letter's contents, it is suggested that San Diego review it carefully and take any steps believed necessary.

- 2* -

LOS ANGELES COUNTY JAIL
BOOKING AND PROPERTY RECORD

BOOKING NO.	LOC. BKD.	DR. LIC. NO.	STATE	STATION RECORDS	
	EPK	N.I.P.			
ARRESTEE'S NAME (LAST, FIRST, MIDDLE)				LENGTH OF TIME RESIDED AT PRESENT RESIDENCE	
JACKSON, LOUIS (NIAW)					
ADDRESS			CITY	SEX	LENGTH OF TIME RESIDED WITHIN STATE
9416 S. FULLER ST. #1			L.A.	M	
DESCENT	HAIR	EYES	HEIGHT	WEIGHT	BIRTHDATE
N	BLK	BRN	509	145	1-13-43
AGE	LENGTH OF TIME EMPLOYED BY PRESENT EMPLOYER				
31					
VEH. LIC. NO.	STATE	RPT. DIST.	AKA/NICKNAME		
01W 186	CALIF.	0700	NONE		
BIRTHPLACE	FILE NO.	AD. PIC	MARITAL STATUS		
TEXAS		N	WARR. ARREST		
AG'Y. OR DETAIL ARRESTING	DATE & TIME ARRESTED	TIME BKD.	NUMBER OF DEPENDENTS		
0101	7-9-74 0230	0235	AGES		
LOCATION OF ARREST	TOTAL BAIL		MISDEMEANOR DISPOSITION BY:		HOLD CITE
1216 E. 94 PL.					
CHARGE	WARR./COMM. NO.		REASON		

JAIL LOC.	ARRAIGN. DATE	TIME	COURT	PRISONER'S SIGNATURE WHEN BOOKED	
EPK				X [Signature]	
SOC. SEC. NO.	OBSERVABLE PHYSICAL ODDITIES			OCCUPATION	
UNKNOWN	2-3" SCARS ON LEFT FOREARM			MOTEL MANAGER	
EMPLOYER (FIRM OR PERSON'S NAME, CITY, & PHONE NO.)			SPECIAL MEDICAL PROBLEM		
FRANCIS LOUIS MOTEL			NONE		
CLOTHING WORN	LOCATION OR DISPOSITION OF VEHICLE				
W/IT. JACKET RED PLUM SLIMES	LEFT AT LOC. PER SUSPECTS REQUEST.				
IN CASE OF EMERGENCY NOTIFY (NAME, RELATIONSHIP, ADDRESS, CITY & PHONE NO.)					
KATHERIN JACKSON WIFE, SAME UNKNOWN PHOENIX					
ARRESTING OFFICER	BOOKING EMPLOYEE	SEARCHING OFFICER	TRANSPORTING OFFICER		
B. WRIGHT 99-34		C. BLACKBURN 0295			

CASH RETAINED	PROPERTY	PRISONER'S SIG., FOR REC'T. OF FOREGOING CASH & PROPERTY			
4.81	NONE	X [Signature]			
CASH DEPOSITED	PROPERTY	PRISONER'S SIG. FOR REC'T. OF REMAINING CASH & PROPERTY			
136.00	MISC: PAPERS, BLU PAPER COMP, 2 BLK PLASTIC FOOT TIP PENS, 1 WHT METAL PEN, 1 PLASTIC KEY BAG WITH 2 KEYS	X [Signature]			

788650B-SH-J-293 2/73

170-286-159

SEARCHED	INDEXED
SERIALIZED	FILED
AUG 14 1974	
FBI - LOS ANGELES	

Bellingham, Wn. 98225
July 5, 1973

Mr. Bill Ritter
Editor
The Door
P.O. Box 5022
San Diego, Calif. 92112

Dear Bill,

Well, here it is. Please excuse the delay, also my wretched handwriting. I have, for the time being, been separated from my typewriter (a small matter of \$500 goes to the workshop). There is only one item regarding the Gunn Radom, omitted. That one I didn't feel safe in putting on paper. So here goes the Godfrey thing:

Godfrey Data

I first saw, but was not introduced to Howard Barry Godfrey at the Stardust Motel San Diego Gun Show in September, 1969. A number of persons, among them Mr. George Hoover and myself, were manning the N.A.R.B.A. booth at the show. Godfrey came frequently to this booth during the three days of the show. On these occasions he would "walk through the show" with Mr. Hoover or Mr. Jerry Lynn Davis, holding

the content of the conversation.

2. In November, 1949 I was asked to go on a "soft penetration" for intelligence gathering purposes, with Godfrey. I was asked to make a report on Godfrey's conduct and ability. Godfrey was introduced to me only as "Barry".

We met at a San Diego tavern, the Arrow Club on El Cajon Blvd. From there we drove to the Lake Elsinore area and visited the home of an elderly gentleman, whose name and supposed importance I have forgotten.

For someone who was supposed to be an "intelligence type", Godfrey impressed me as ill-fitted for the role. He alternately exhibited physical traits or gestures — particularly his eyes and hands — which I would classify as; 1) sly or sneaky, 2) nervousness or cowardice and 3) awareness of personal guilt. All of these, despite the fact we were breaking no laws, doing no harm and in the house at the invitation of its owner.

Following the "interview", we left the

subject's house and I discovered that we were being followed. Reluctantly — and that's the only way I can describe Godfrey's attitude — he followed my instructions to try to shake our surveyors. Normally, I am fairly competent in breaking a surveillance, but this time it didn't work. Even though we doubled back on the car following us and pulled into a service station, the car was behind us again when we entered the freeway Southbound. Godfrey "panicked" then, increasing his speed and driving directly to San Diego and to a Chinese restaurant where we met his superior, Bill Clay.

In retrospect, wherein we all become geniuses, I can conclude that the surveillance team following us that night consisted of Special Agent Petersen or Christiansen and other FBI storm troopers. That Godfrey's reluctance and panic came from his fear of doing anything counter to his instructions from his employers (the FBI).

3. During the period of November, 1969 to Summer of 1971, Howard Godfrey frequently came to Gunsmoke Ranch on weekends

When various forms of script shooting were practiced for recreation. On these visits, which were always brief - lasting less than an hour - he would take Mr. Hoover or Mr. Jerry Lynn Davis aside for quiet conversations. During these visits, he would "act" as if he did not know Bill Clay or myself.

It was during this time that I learned he had been appointed "Director of Intelligence" for the San Diego area sector of the Minutemen.

4. In August of 1971, Godfrey came to my apartment and requested I verify addresses and phone numbers for a series of names he had on 3x5 note cards. He then proceeded to try to "recruit" me for "his intelligence network".

5. It was also during June, July or August of 1971 that both Godfrey and Donald Signetti - posing as "Don Simms" - visited Runsmoke Ranch and, although supposedly "not knowing each other", they spoke together, on at least one occasion, in a manner similar to the conversations Godfrey had previously held with Mr.

Hoover and Mr. Davis.

2. Following these "casual conversations" between two spectators at a shooting match, in October, 1921, Godfrey came up with bizarre ideas to "take care of these Red punks" if the Republican Convention was held in San Diego. Also, a number of us received literature on a new group, the SAO. Mr. Fleury and I were given specific instructions not to involve ourselves in any way with the SAO. Mr. Fleury continued to receive SAO literature (unmasked) although I did not.

Some of Godfrey's ideas included:

1. The use of massive dosages of LSD, cyanide or strychnine introduced into the punch at Anti-war group meetings.
2. Bombing of VVAW headquarters, the Guild theatre and several porno shops.
3. Bombings of the homes or offices of Anti-war leaders.
4. Kidnaping or assassination of Anti-war leaders and activists.
5. Fire bombing of vehicles and other property belonging to Anti-war activists.

NOTE: Our general attitude toward Godfrey

and his proposals at that time as;
"He's a fucking nut!"

By November and December of 1971, Godfrey's "ideas" had solidified — along with the decision to hold the Republican Convention in San Diego. His other ideas having been rejected (I have a strong suspicion that some of them were carried out or attempted by Godfrey) he now proposed that someone construct radio controlled, Freeflight model airplanes to carry payloads of HE and white phosphorous, to be flown over Vacation Island and detonated. When Mr. Hoover, Mr. Fleury and I heard of this idea we rejected the possibility out of hand.

Godfrey likewise attempted to involve others in a conspiracy to manufacture a similar aircraft, loaded with TNT or C-4 plastique, to be flown into Air Force 1 as it landed at Lindberg Field or El Toro Marine Air Base at San Clemente. When I heard rumor of this, I expressed the opinion that Godfrey had lost his mind to ever suggest anything as insane as an attempt on the life of the President. I further stated that if I ever received information that he was actually proceeding, I would report it to the Secret Service.

others, including Mr. Hoover expressed the same attitude. In retrospect, it appears that those comments must have found their way to Godfrey.

During this time I also learned Godfrey was "San Diego leader" of the S.A.O.

8. In December, 1971, Godfrey attempted to get someone to assassinate Dr. and Mrs. Bauer, Ned von Valkenberg, Peter Banner and other Anti-war leaders. Again he was refused by everyone he contacted.

9. On January 6, 1972, the attack was made on Peter Banner's home by Godfrey and someone else, whose identity as yet remains unknown.

10. In February, 1972, on two occasions, shots were fired at Mr. Richard Flourey at his home. (He, like Hoover and I, had refused to go along with any of Godfrey's wild ideas.)

My apartment in San Diego was under surveillance by someone and I was fired at on one occasion where I was staying out of sight. Godfrey told Mr. Hoover that, "Banner's People figure it was you and Busch who took the shots"

art a. contract on you L.B. #11."

No sooner was this said than Godfrey began to pressure me to return to my apartment. (He had told Mr. Hoover not to tell me about the "contract" or the surveillance, but Mr. Hoover did.) I reflected that outside of Mr. Fleury, who had also been shot at, Mr. Hoover, his employer and my mother, only Godfrey knew where I was staying. I thus concluded it was he and/or members of his (by his claim) forty person "intelligence" network who had fired the shots at Mr. Fleury and ~~myself~~ myself.

Therefore, on March 2, 1972, I left San Diego County and the United States in fear of my life. (One can not, after all, protect oneself from a hidden assassin!) In light of what has transpired since, I have remained out of the area ever since.

Sure hope this will help, Bill.

Best of luck,
Jimmy Burch

P.S. Bill, just talked today (Friday, 7-6) with Wanda Trout of L.A. Times. Please send her a copy of this. J.B.

Date prepared

2/11/75

Date received

2/7/75

Received from (name or symbol number)

INFORMANT

Received by

SA Earl M. Peterson

Method of delivery (check appropriate blocks)

in person by telephone by mail orally recording device written by Informant

If orally furnished and reduced to writing by Agent:
Date

Dictated _____ to _____

Transcribed _____

Authenticated by Informant 2/1/75

Date of Report

2/1/75

Date(s) of activity

1/17/75

1/31/75

Brief description of activity or material

NOT GERMANE TO Godfrey

File where original is located if not attached

170-512A

* INDIVIDUALS DESIGNATED BY AN ASTERISK (*) ONLY ATTENDED A MEETING AND DID NOT ACTIVELY PARTICIPATE. VIOLENCE OR REVOLUTIONARY ACTIVITIES WERE NOT DISCUSSED.

Information recorded on a card index by _____ on date _____

Not germane to Godfrey

① 170-286 (Godfrey)

NOT GERMANE TO Godfrey

Block Stamp

170-286-167

SEARCHED _____	INDEXED _____
SERIALIZED _____	FILED _____
FEB 19 1975	
FBI - SAN DIEGO	

102

PT. Ron Eddy; George Mitchell Hoover.

It has been ascertained that at this time Ron Eddy of Poway is not interested in trying to form or lead any type of security force for any right-wing extremist group. When asked by James K. Warner of Los Angeles (via Dennis Loso of Escondido) if he would do this, Eddy stated that he would like to see the formation of a Security Force with teeth in it but does not consider himself to be enough of a leader to do it himself.

While declining to lead a Security Force, Eddy did say that the only way to stop FBI infiltration of rightist groups would be for one of the infiltrators to "wind up in the river" someday. Eddy is positive that Tom Knight's San Diego unit of the Nazi Party has a regular FBI infiltrator. The only three men of whom he is not suspicious are Mickey Wakefield, Ray Wilson and Gerald Smith. Said Eddy, "Those three men dropped out of the thing and so I figure they're okay but you can bet that the fink is still in there pushing".

Loso said that the whereabouts of people like Barry Godfrey should be learned and they should be telephoned and intimidated. Eddy said he thinks such intimidations would be a waste of time and that people like Godfrey should be killed. Mickey Wakefield of San Marcos went along with Eddy's suggestion. Ron Eddy also mentioned having had an encounter with an FBI agent named Peterson in San Diego but did not elaborate.

Eddy firmly believes that any man who commits himself to one organization in the Far Right should not be involved with others. He says he would be very suspicious of anyone who is. He is also somewhat suspicious of Tom Knight. He says that Joe Brinker gave Knight the name of a man interested in Nazism and two weeks later the FBI interviewed the man. Also, Eddy wonders how Knight saved his federal job in the face of his continued Nazi activities. Eddy feels that any regular rightist extremist who stays on with the Nazi Party now must warrant heavy suspicion of being an FBI informant.

On Friday night, January 31, 1975 Ron Eddy met Tom Metzger of Fallbrook for the first time. Metzger showed Eddy some pictures and slides of New Christian Crusade activities and the two seemed to hit it off pretty well. Metzger told Eddy, Wakefield and Loso of a visit he received at his home on January 17, 1975 from agents of the Internal Revenue Service. He said the agents were nervous.

INFORMANT

George Mitchell Hoover

Here is one last bit of information. The New Christian Crusade people are very concerned about the imprisonment of George Hoover of the Secret Army Organization. At one of their banquets the NCC had four unoccupied places set at the table which were in honor of four men whom they hold to be absent heroes. These four men were Joe McCarthy, George Hoover, Charles Lindbergh and a man named R. Miles.

Anyway, it has been learned that a man whom Tom Metzger knows is going to take a dossier of the Hoover case to some congressman in Washington, D.C. who is part of a committee currently scheduled to investigate the FBI. The dossier consists of newspaper clippings and other material pertaining to Hoover's activities in the SAO, his arrest, conviction, appeal, etc. They are hoping to stir up a big publicity stink to give the FBI a bad name due to Barry Godfrey's activities and in so doing hope to effect an eventual release of Hoover from prison. By the way, the NCC people do not refer to Hoover by his correct name. For some reason they all call him Mickey Hoover.

That is about all for now. I hope this will be of some help to you.

INFORMANT

NOT GERMANE
TO Godfrey
1 page

UNITED STATES GOVERNMENT

Memorandum

TO : SAC (170-286)

DATE: 5/16/74

FROM : SA EARL M. PETERSEN

SUBJECT: HOWARD BARRY GODFREY
INFORMATION CONCERNING

HOWARD BARRY GODFREY has applied for a position as Arson Investigator for the State of California. He scored the top grade in his test and is now being investigated by the California Bureau of Investigation for this position. He is presently working for the State of California in a similar position. SA FRANK M. THOMPSON, CBI is conducting the investigation:

The following information which has all been made public was given to SA THOMPSON upon authority of the SAC:

Opened 2/2/67
HOWARD BARRY GODFREY, Born July 1, 1943, at Portsmouth, England, was an informant of the FBI from August 10, 1967. to November 14, 1972. He reported to the San Diego office. This service was entirely voluntary on his part. During this period of time he furnished a volume of highly reliable information about right wing type groups such as the Minutemen and the Secret Army Organization. He was reimbursed for his service in amounts ranging ~~xxxxx~~ up to \$250.00 per month.

On June 22, 1972, GODFREY furnished information indicating that one WILLIAM FRANCIS YAKOPEC intended to bomb "Genies Massage Parlor" in El Cajon. Due to the possibility of loss of life if this bombing was carried out, it was decided to make GODFREY available to testify in the trial of YAKOPEC who had placed a bomb in the Guild Theatre in San Diego on June 19, 1972. As a result of information furnished by GODFREY, a number of persons were tried and convicted and large quantities of firearms, explosives and ammunition were recovered.

The names of individuals arrested tried and convicted was given to SA THOMPSON.

EMP:emp
(2)

170-286-156

SEARCHED	INDEXED
SERIALIZED	FILED
MAY 16 1974	
FBI - SAN DIEGO	
[Signature]	



4/5/74 INFORMANT

Earl B. Peterson

Method of delivery (check appropriate blocks)

in person by telephone by mail orally recording device written by informant

If orally furnished and reduced to writing by Agent:

Date of Report

Dictated 4/6/74 to Sue Fox

4/5/74

Transcribed 4/8/74

Date(s) of activity

Authenticated by Informant _____

3/28/74

Brief description of activity or material

MCC meeting 3/28/74 - S.D.

File where original is located if not attached

170-544A-

* INDIVIDUALS DESIGNATED BY AN ASTERISK (*) ONLY ATTENDED A MEETING AND DID NOT ACTIVELY PARTICIPATE IN VIOLENCE OR REVOLUTIONARY ACTIVITIES WERE NOT DISCUSSED.

Information recorded on a card index by _____ on date _____

NOT GERMANE
TO GODFREY

Block Stamp

170-286-155

SEARCHED	INDEXED
SERIALIZED	FILED
APR 1 1974	
FBI - SAN DIEGO	

NOT

GERMANE

TO

Godfrey

INFORMANT

4/5/74

Meeting of Colonel WILLIAM GALE at
O'Neira Hall on the Evening of
March 28, 1974, San Diego, California

NOT GERMANE

TO

Godfrey

NOT GERMANE
TO GODFREY

Colonel GALE discussed an article on himself and the identity movement as written up in Volume V, Issue 14, of a bi-monthly publication, called the San Diego Door. I believe that's a March, 1974 issue. Colonel GALE read directly from the article and made comments and corrections as he went.

NOT GERMANE
TO GODFREY

NOT
GERMANE

To Godfrey

I will make another quote here from the publication:

"JERRY LYNN DAVIS, the ex-head of the SAO in California,
has been reported at GALE's public meetings." According
to MICKEY WAKEFIELD ^{identifies}_{INFORMANT}

DAVIS had not, as far as he knew, ever been to a
San Diego meeting.

NOT GERMANE
To Godfrey

NOT

GERMANE

To

Godfrey

2 pages

that was when he was involved in counter-insurgency and that was with the guerrilla activities in the Philippines, which was also indicated in this article.

Then, another interesting thing, he quoted: - "The SAO was in large part organized by HOWARD B. GODFREY, an FBI Agent." He didn't have anything notable to say about

NOT GERMAN^e
TO Godfrey

NOT GERMANE

TO GODFREY

4 PAGES

Date received: 4/5/74
Received from (name or symbol number): INFORMANT
Received by: SA Carl M. Bateman

Method of delivery (check appropriate blocks):
 in person by telephone by mail orally recording device written by Informant

If orally furnished and reduced to writing by Agent:
Date: _____
Dictated _____ to _____
Transcribed _____
Authenticated by Informant: 3/31/74

Date of Report: 3/31/74

Date(s) of activity: 3/30/74

Brief description of activity or material:
No one from NSWSP went to LA to see Triumph of the Will.

File where original is located if not attached:
170-512A

* INDIVIDUALS DESIGNATED BY AN ASTERISK (*) ONLY ATTENDED A MEETING AND DID NOT ACTIVELY PARTICIPATE IN VIOLENCE OR REVOLUTIONARY ACTIVITIES WERE NOT DISCUSSED.
 Information recorded on a card index by _____ on date _____

Remarks:

NOT
GERMANE
TO
Godfrey

EMB:8
(10)

Block Stamp
170-286-154
SEARCHED [] INDEXED []
SERIALIZED [] FILED []
APR 5 1974
FBI - SAN DIEGO

NOT GERMANE
TO Godfrey

① 170-256 (Hodfey)

NOT GERMAN
to Godfrey

Vic Walton claims to have "put out the word" on Barry Godfrey "a good year" before the arrests of members of the Secret Army Organization in San Diego. Walton says he warned the SAO people to look out for Godfrey because he believed Godfrey to be half Jewish and, therefore, untrustworthy. Walton says Godfrey was too pre-occupied with firearms and explosives to be trusted. He admitted, however, that this seemed to appeal to the SAO affiliates.

That is all for now.

INFORMANT

Date prepared 3/26/74

Date received 3/25/74

Received from (name or symbol number) INFORMANT

Received by SA Paul M. Beltrami

Method of delivery (check appropriate blocks)
 in person by telephone by mail orally recording device written by Informant

If orally furnished and reduced to writing by Agent:
Date _____
Dictated _____ to _____
Transcribed _____
Authenticated by Informant 3/25/74

Date of Report 3/25/74

Date(s) of activity 3/24/74

Brief description of activity or material
Target Shooting Smith Wakefield to Wilson

File where original is located if not attached
170-512A

* INDIVIDUALS DESIGNATED BY AN ASTERISK (*) ONLY ATTENDED A MEETING AND DID NOT ACTIVELY PARTICIPATE. VIOLENCE OR REVOLUTIONARY ACTIVITIES WERE NOT DISCUSSED.
 Information recorded on a card index by _____ on date _____

Remarks:

NOT
GERMANE
TO Godfrey

EMB:8
8

Block Stamp
170-286-153
APR 2 1974
SA Paul M. Beltrami

NOT
GERMANE

TO
Godfrey

6- 157-3017 (George Horner)

① 170-286 (Godfrey)

INFORMANT

NOV 27, 1954

NOT GERMANE
TO GODFREY

Vic Walton's Attitude

Vic Walton recently expressed his opinion of George Mitchell Hoove. He said of Hoover, "He is not the kind of man I would ever want to have for an enemy because I don't think he would hesitate to do you in". Walton continued, "However, Hoover seems like a real nice guy". "He is very quiet and doesn't have much to say".

Walton is very anxious to have Ron Eddy of Poway read Nature's Eternal Religion. Walton is really making a determined effort to push this book. Its author, Ben Klassen, seems to think Hitler was the best thing that ever happened to the world and concludes his book by saying that ultimately the White race will have to occupy all the usable land on Earth. That kind of tells you something without really saying it. Walton says that Barry Godfrey once told him that his (Walton's) telephone was bugged.

That's it for now.

INFORMANT

Date received 3/25/74 Received from INFORMANT or symbol number) Received by SA Earl M. Peterson

Method of delivery (check appropriate blocks)
 in person by telephone by mail orally recording device written by Informant

If orally furnished and reduced to writing by Agent:
Date _____
Dictated _____ to _____
Transcribed _____
Authenticated by Informant 3/24/74

Date of Report
3/24/74

Date(s) of activity
3/23/74
3/28/74
4/11/74

Brief description of activity or material
NSWOB meeting 3/23/74
New Political Unit to be formed by V. Walton
Jessie's Practice - Wakefield, Smith & Wilson

File where original is located if not attached
170-572A

* INDIVIDUALS DESIGNATED BY AN ASTERISK (*) ONLY ATTENDED A MEETING AND DID NOT ACTIVELY PARTICIPATE IN VIOLENCE OR REVOLUTIONARY ACTIVITIES WERE NOT DISCUSSED.

Information recorded on a card index by _____ on date _____

Remarks:

NOT GERMANE
TO Godfrey

Block Stamp
170-286-152
SEARCHED tip
SERIALIZED tip
APR 2 1974
FBI - SAN DIEGO
12

(1) 170-286 (Barry Godfrey)

EMPI 18
(14)

NOT GERMANE
TO GODFREY

NOT GERMANE

TO Godfrey

1 page

NOT GERMANE
TO GODFREY

Vic Walton says that Parry Godfrey once gave him two cans of illegal powder. Because he suspected that the stuff was illegal, he claims to have disposed of it. Walton says he has information from a "pretty reliable source" that Godfrey is currently employed by the Sacramento Fire Dept.

NOT GERMANE
TO GODFREY

INFORMANT

NOT

GERMANE

To Godfrey

1 page

(Mount Clipping in Space Below)

Hearings Recess In Perjury Case

A hearing to determine whether a 1972 conviction of an alleged member of the Secret Army Organization should be overturned was continued yesterday pending receipt of answers from a former FBI agent involved in the initial investigations.

Superior Court Judge James C. Toothaker took the action at the request of Deputy Dist. Atty. Henry Mann and attorney Laurence C. Baldauf Jr., representing Calvin Fox.

Fox was convicted of perjury during the trials here. He was charged in connection with his denial that he was a member of the SAO, a right-wing paramilitary organization.

MYSTERY WITNESS

A mystery witness, whom Baldauf said he might call for the writ of habeas corpus hearing, failed to materialize yesterday.

Baldauf had hinted that "Jerry Bush," whom he described as having testified before the Senate Watergate Committee, might appear despite a threat on his life.

Bush's name was not mentioned during the hearing yesterday.

MOCK SHOOTOUTS

Other sources said Bush, 38, had lived here at one time, appearing in mock shootouts at the now-closed Frontier Village at Big Oak

Ranch in Harbison Canyon in 1962-64, and also in films made there.

He was said to be a freelance writer now, and was reported to have returned here about two months ago, staying until a week ago.

Mann and Baldauf agreed to submit written questions that would be put to former FBI agent Steve Christensen.

(Indicate page, name of newspaper, city and state.)

SAN DIEGO UN
2/21/74

Date:

Edition:

Author:

Editor:

Title:

Character:

or *Perjury*

Classification:

Submitting Office:

Being Investigated

170-286-15

SEARCHED	INDEXED
SERIALIZED	FILED
FEB 21 1974	
FBI - SAN DIEGO	

'72 Perjury Witness Challenged

—B-4—THE SAN DIEGO UNION

—Wedn

Informer in SAO Trials Challenged

By BILL OTT

(Continued)

Howard Barry Godfrey, a former paid FBI informant and key prosecution witness in the series of 1972 Secret Army Organization trials here, yesterday was described by an attorney in Superior Court as a dangerous figure who, if not exposed in court, will be exposed by the Watergate Committee.

The allegation was by Laurence C. Baldauf Jr., attorney for Calvin Fox, who was convicted of perjury during the trials. He was charged in connection with his denial that he was a member of the SAO, a right-wing paramilitary organization.

Baldauf, who is seeking to overturn Fox's conviction, also raised the possibility of a mystery witness in his arguments before Judge James C. Toothaker for a writ of habeas corpus.

During arguments, he named the man as "Jerry Bush," saying he is "in San Diego." Baldauf also said Bush might testify, despite the fact that his life has been threatened.

Baldauf also had admitted into evidence a declaration by Bush over the objections of Deputy Dist. Atty. Henry Mann, who claimed the statement was not relevant.

(Continued on B-4, Col. 1)

to the proceedings. Baldauf later withdrew Bush's declaration with the consent of Mann and Toothaker. In withdrawing it, Baldauf said the contents should not be disclosed to the public because Bush had testified before the Watergate Committee and had been admonished not to make any public statements.

Mann, in making his earlier objection to admitting Bush's declaration, called the statement "highly inflammatory."

'CONCERN FOR SAFETY'
Baldauf added that Bush was "concerned for his safety."

There were no further references to him, other than the arguments on admitting and then withdrawing his declaration.

Baldauf in his arguments attacked the credibility of Godfrey as a prosecution witness in the SAO trials, at one point saying "Mr. Godfrey is an arch criminal" who "unless taken into tow" may "kill someone," possibly the "President of the United States."

PRICE TESTIFIES

Earlier, Baldauf called as a witness Deputy Dist. Atty. L. Forrest Price, who prosecuted Fox. When questioning Price, Baldauf asked him if he had been aware at the time that Godfrey had been involved in a "plan to

fly a drone into Air Force One (the presidential plane) as it was flown into San Diego."

Price said he was not aware of such a plan.

Baldauf also asked Price if he had any knowledge of a meeting between Godfrey and Donald Segretti at Gunsmoke Ranch in Harbison Canyon here. Segretti, 32, has pleaded guilty to one count of conspiracy and three counts of distributing illegal campaign literature in connection with the last presidential campaign. He was sentenced to six months in prison.

Price said he was not aware of such a meeting.

DEFENSE ARGUMENTS

Baldauf is arguing that Fox was denied a fair trial and due process because the prosecution, at the time of his trial, withheld information and at least one witness who should have been allowed to testify for the defense — Steve Christensen, a former FBI agent to whom Godfrey reported when he was assigned to infiltrate extremist groups.

Fox was convicted of perjury on Dec. 6, 1972, after a nonjury trial before Judge Bensali Noon. Fox, 44, was the owner of an El Cajon service station at the time, an establishment allegedly searched by FBI agents.

(Indicate page, name of newspaper, city and state.)

SAN DIEGO UNION
2/20/74

Date:
Edition:
Author:
Editor:
Title:

Character:
or

Classification:
Submitting Office:

Being Investigated

170-286-150

SEARCHED	INDEXED
SERIALIZED	FILED
FEB 20 1974	
FBI - SAN DIEGO	

INFORMANT

January 30, 1974

ACTS: Relocation of Ray Wilson; party for Nazi affiliates; Calvin Fox's accusations against Howard Barry Godfrey.

NOT GERMAN
TO GODFREY

Calvin Fox's Accusations Against Barry Godfrey

The enclosed leaflet is apparently being circulated by Calvin H. Fox of El Cajon. However, the source of the particular copy enclosed here was Ray Wilson of San Diego. Fox comes on pretty strong against Godfrey.

That is about all for now. Will be in touch again soon.

INFORMANT

Informers Is Linked Right-Wing Violence

By STEVEN V. ROBERTS
Special to The New York Times

ALGO, June 23 — A leader of a paramilitary organization, among other things, here for more than a year says that the group was partly organized and financed by an informer of the Federal Bureau of Investigation, an informant, and others.

Howard Barr, Godfrey, participated in a slaying, as well as at fire-bombings and burglaries, and receiving regular payments from the FBI for his services, it was said. His account was provided this week by Jerry Lynn Davis, the former Secret Army Organization, a well-armed group, and another right-wing group, the Minutemen.

Segretti Recognized
Another development this week, two members of the Secret Army Organization reportedly recognized a photograph of Donald H. Segretti, the young lawyer and organizer of a Republican campaign last year. According to Davis, a local radical newspaper, the Minutemen identified the man in the photograph as "Donald Smims," whom they met in the summer of 1971 at a shooting range frequented by members of the Secret Army Organization.

Two men reportedly said that "Smims" was present at a discussion of the right-wingers about the Republican National Convention, which was scheduled to be held in San Diego last August before it was moved to San Diego. "Smims" did not participate in the discussion but an eyewitness, a companion did, according to the sources.

Segretti, who has been indicted for distributing false campaign literature in California, often used the name "Donald Smims" in recruiting espionage agents. It is also known that Mr. Segretti and members of the Secret Army Organization at different times discussed the idea of abducting Davis, but so far, there has been no firm link between Mr. Segretti to the right-wing group.

Davis, a 31-year-old construction worker, spoke to a reporter after being released last Thursday from jail where he had been held pending his sentencing on charges of possession of explosives. The Secret Army Organization co-ordinator

had pleaded guilty and was granted probation.

According to Davis's account, the Secret Army Organization was formed in 1971 to train guerrillas who could organize a resistance movement should the United States be conquered by a foreign power. Howard Godfrey, the FBI informer, was one of the six founding members and contributed the money used to print the group's recruiting literature, Davis said.

In addition, Godfrey was considered a "firebrand" within the organization and took a "more militant line" than most members, Davis said.

Godfrey told friends, and in some cases later testified in court, that he had participated in a series of violent actions against the rather small but vocal community of left-wing radicals in San Diego.

In one case, he admitted breaking into the offices of The Street Journal, a left-wing newspaper, and destroying printing equipment valued at several thousand dollars. In another case, he said he burglarized the Message Information Center, a counter-culture outpost, and stole their records.

Law enforcement agents say that Godfrey also performed several other burglaries and fire-bombed at least two cars belonging to radical sympathizers.

Agent Hid Gun

According to his own court testimony, Godfrey was riding in a car on Jan. 6, 1972, when another member of the Secret Army Organization fired a shot into a house occupied by young leftists. The bullet shattered the elbow of a girl named Paula Tharp. Miss Tharp and other residents of the house were planning demonstrations at the Republican convention.

Godfrey took the gun used in the shooting and gave it to his FBI contact. The agent hid it under his couch for six months until the Secret Army Organization member who shot Miss Tharp was finally apprehended by the police. The incident cost the agent his job.

Given Godfrey's contributions to the Secret Army Organization in time and money, Davis said, "you might say that the SAO was a federally funded anti-poverty program for the right wing."

Some investigators here believe that Davis is exaggerating Godfrey's role somewhat, but they agree that "he was obviously a leader in the organization."

"AT POINT IN TIME" THE OCTOBER 1973 ISSUE OF RAMPART MAGAZINE SAYS THAT GODFREY, THE FBI INFORMER, ADMITS HE WAS PLOTTING TO KILL PRESIDENT NIXON IN SAN DIEGO!

ISN'T IT JUST NICE THAT THE SAN DIEGO COURT JUDGE PUT TWO MEN IN PRISON FOR LIFE SOLELY ON THE WORD OF THIS CRIMINALLY INSANE INFORMER.

THIS CLEVER PARANOID, GODFREY, WAS WORKING UNDER L. PATRICK GRAY, NIXON'S APPOINTEE, WHO ADMITTED BURNING THE CONTENTS OF E. HOWARD HUNT'S WHITE HOUSE SAFE TO COVER UP THE C.I.A. PLOT TO SUBVERT THE CONSTITUTIONAL PROCESSES OF OUR GOVERNMENT.

THIS BUILDS STRONG SUSPICION OF LOCAL JUDICIAL CONNECTIONS TO THE WATERGATE SCANDAL.

I PROTEST! YOU, TOO, MUST PROTEST TO SAVE OUR REPUBLIC!

SINCERELY,
Clavin
900 BROADWAY
FL. CAJON, CALIF 92021

...this printing a ruling of the Appeals Court has overturned the conviction of one of the persons mentioned above--ON THE CREDIBILITY OF THE FBI WITNESS, GODFREY!!

Editor:

In May, 1972 when the Committee to Re-elect the President hired ex-FBI agents to bug 200 telephone calls at Democratic Headquarters (to save the country from communism), "Captain" Howard Barry Godfrey, another FBI operator, was spending his "expense" money at my service station, 900 E. Broadway in El Cajon, buying tires, batteries, and servicing for his 1961 Rambler (which he says he drove as the getaway car in the shooting incident at Professor Bohmer's home).

Since I have been an outspoken opponent of Chairman Nixon, it appears that "Captain" Godfrey was assigned to go to the county grand jury in June and name me as one of the members of his "Secret Army Organization" so that when I was subpoenaed to testify as a witness in the Yakopec trial, a bomb would be thrown at my station (on the same date as the subpoena), a rental truck destroyed, and a week later my contract with Hertz canceled.

It probably had nothing to do with my opposition to Nixon, but after I denied membership in the SAO ("an appendage of the FBI"), at the Yakopec trial, the almost all white (collar) county grand jury indicted me for perjury.

On Dec. 6, Judge Bonsall Noon found me guilty and sent me to jail for six months with five years probation

lacked on so I could be thoroughly watched by authorities for the remaining term-duration of the President...

Oh, incidentally, the only witness for the prosecution that I was an SAO member was "Captain" Godfrey. He had NO piece of corroborative evidence to produce to the court—only his mouth. It was his mouth (alone) which prompted Judge Conyers to become "outraged" over the FBI failure to produce evidence in the - in the Yakopec trail. All evidence in my case was circumstantial (planted), also.

When I appealed the sentence Judge Noon first refused bail. Then after my attorney appealed that, he did consent to set bail at a reasonable (?) \$25,000! It was only \$10,000 in the beginning!

But don't get upset, gentlemen. This sort of political persecution is practiced in Communist Yugoslavia I know. My wife is from there. I just brought her out of her native country seven years ago!

She is petrified with fear of political provocateurs and informers again. Horrah for "Americanism"—Nixon-Gray style! Watergate! Watergate! Watergate! Who knows what lurks in the Watergate-West?

Calvin H. Fox, No. 589703
P.O. Box 2952
222 West C St.,

AS "CAPTAIN" GODFREY WORKING FOR THE FBI OR THE "COMMITTEE TO RE-ELECT THE PRESIDENT?" Turn the page for startling facts that point to the latter. You must decide from the circumstantial evidence, much the same way as a jury decides in a court trial.

AS THE WATERGATE EVEN A SECRET RMY? HOW MANY OF THEM WERE NAMED? WILL WE EVER BE OLD HE RUTH?

San Diego Link To Watergate Case Reported
WASHINGTON (UPI) — The Watergate trial was told yesterday that President Nixon's campaign managers, fearful of violence and bodily harm to White House aide G. Gordon Liddy to set up a \$250,000 "intelligence-gathering network," Job Stuart Magruder, former FBI agent, testified yesterday that Mr. Nixon ordered the San Diego to Miami Beach as a result of last summer's GOP National Convention switched from San Diego to Miami Beach as a result of Liddy's estimates of the number of antiwar demonstrators expected at San Diego. However, Magruder said he had never directed Liddy to head or wiretap Democratic headquarters at the Fairrate, or to try to bug Sen. Conrad S. McGovern's campaign offices on Capitol Hill.

Wednesday, January 24, 1973

Campaign managers were concerned, he said, that "it would be very difficult for the President to be re-elected" if the convention suffered the same violence that wracked the Democratic convention in Chicago in 1968. Campaign Treasurer Hugh W. Sloan Jr. testified he gave the money for Liddy's operation on orders from Mr. Magruder. Sloan also testified that he authorized the money for Liddy's operation on orders from Mr. Magruder. Sloan replied, "I have no idea."

CONFIRMS ACTION Under questioning, Sloan also confirmed for the first time that he left the Nixon campaign because of concern over the Watergate affair.

Sloan also said he turned over \$9,000 in Nixon campaign contribution checks to Liddy to be converted into cash. This was done, Sloan said, because of the campaign finance reporting laws which subject individual contributions of more than \$5,000 to a gift tax. He said the five checks ranged in amounts from \$15,000 each to \$25,000.

Liddy and James W. McCord Jr., who was one of five men arrested June 17 inside Democratic headquarters, were charged with conspiracy, burglary and wiretapping in connection with the

NOT GERMANE
TO GODFREY
2 PAGES

Date prepared
11/29/73

Date received: 11/20/73
Received from (name or symbol number): INFORMANT
Received by: SA EARL M. PETERSEN

Method of delivery: in person by telephone by mail orally recording device written by informant

If orally furnished and reduced to writing by Agent:
Date: _____
Dictated _____ to _____
Transcribed _____
Authenticated 11/17/73
by Informant _____

Date of Report: 11/17/73

Date(s) of activity: 11/17/73

Brief description of activity or material:
NSWPP DEMonstration in Los Angeles 11/17/73

File where original is located if not attached:
SD 170-512A

* INDIVIDUALS DESIGNATED BY AN APOSTRICH (') ONLY ATTENDED A MEETING AND DID NOT ACTIVELY PARTICIPATE. VIOLENCE OR REVOLUTIONARY ACTIVITIES WERE NOT DISCUSSED.

Information recorded on a card index by _____ or date _____

Remarks: Further dissemination by offices receiving copies of this report are left to the discretion of those offices.

Index to 100-15355: Mark Roberts, alias of Terry Busch.

100-15355+ 56-49-67p 2

NOT
GERMANE
TO
Godfrey

① 170-286 (royara Barry Godfrey)

Block Stamp
SEARCHED _____ INDEXED _____
SERIALIZED _____ FILED _____
FBI - SAN DIEGO
149

NOT
GERMANE

TO
Godfrey

2 pages

NOT

GERMANE
TO Godfrey

Phony Name Given

It has been learned that Jerry Busch was present at Vic Walton's in La Mesa on the night of the 16th. He gave Commander Koehl the alias name "Mark Roberts" when the commander asked who he was. Busch appears to be friendly with Stan McDade and is said to have been a close friend of George Hoover in the Secret Army Organization. This same trick had been used by Mike Johnson of La Mesa when he was first introduced to Joe Tommasi last July. At that time he gave his name as being Kuychenda (pronounced Kirkendall).

NOT GERMANE

TO Godfrey

Ron Eddy of Poway states he has all of the coming week off and that he desires to accompany Wakefield and Knight to their scheduled trial for disturbing the peace on Wednesday, November 21, 1973. Eddy also reiterated his hope that bail on George Hoover will be lowered sufficiently to get him out. Eddy said he would be willing to borrow money from his credit union and put up the equity in his house as collateral to get Hoover out of jail. Eddy says that the only way to prevent people from serving as informants for the FBI is to make examples of some of them. Eddy believes that Hoover would murder Barry Godfrey if he could find him and I think he is hoping something like that will happen. When it becomes necessary for Godfrey to return to San Diego, I cannot over-emphasize the importance of maintaining heavy security for him. If he thought he had half a chance of getting away with it, I believe Eddy himself would murder Godfrey just to "make an example".

That is about all that is known to have happened in the past couple of days. I hope it is of use to you.

INFORMANT

NOT GERMANE

TO GODFREY

2 PAGES

Date prepared

11/12/73

Date received

Received from (name or symbol number)

Received by

11/12/73

INFORMANT

SA Earl M Peterson

Method of delivery (check appropriate boxes)

in person

by telephone

by mail

orally

recording device

written by letter

If orally furnished and reduced to writing by Agent:

Date

Date of Report

11/10/73

Dictated

to

Date(s) of activity

11/9/73

Transcribed

Authenticated by Informant

11/10/73

Brief description of activity or material

San Diego NSW P.P. meeting 11/9/73

File where original is located if not attached

SD 170-512A

* INDIVIDUALS DESIGNATED BY AN ASTERISK (*) ONLY ATTENDED A MEETING AND DID NOT ACTIVELY PARTICIPATE IN VIOLENCE OR REVOLUTIONARY ACTIVITIES WERE NOT DISCUSSED.

Information recorded on card index by

on date

Remarks:

NOT GERMANE
To Godfrey

Block Stamp

170-181-147

SEARCHED INDEXED

SERIALIZED FILED

NOV 15 1973

FBI - SAN DIEGO

ai

NOT GERMANE

to Godfrey

1 pg.

NOT GERMANE
TO
Godfrey

Ron Eddy

Ron Eddy had a very great deal to say on this night. He covered two subjects--morality and especially the FBI.

He spoke of some of the sleazy looking places on South Broadway in San Diego. He said, "They're full of White girls being used as whores by nigger pimps and nigger customers." "South Broadway is one huge whore house." "I'd like to take a submachinegun and walk into those places and just clean house." He went on, "I hope right just as well have sent it that way because he's up the river for just as long as if he'd killed someone." Eddy said that if the bail on George Hoover is lowered sufficiently, he will bail him out. He said, "And if I can find out where Barry Godfrey is, I'll point Hoover in that direction because I think it's the only thing that will get out of him."

Many things were said by "FBI" agents and informants of that organization. He carried out from both agents and informants of that organization. He said, "I wish you could see the way the FBI is run. He said, "I wish you could see the way the FBI is run. He said, "I wish you could see the way the FBI is run."

NOT GERMAN e
TO Godfrey

INFORMANT

Date prepared

11/12/73

Date received

11/1/73

Received from (name or symbol number)

INFORMANT

Received by

SA Earl M. Peterson

Method of delivery (check appropriate boxes)

in person

by telephone

by mail

orally

recording device

written by Informant

If orally furnished and reduced to writing by Agent:

Date

Dictated

to

Transcribed

Authenticated by Informant

10/20/73

Date of Report

10/20/73

Date(s) of activity

9/8/73

Brief description of activity or material

Info re NSW 88 discussion re
Godfrey

File where original is located if not attached

SD. 170-512A

* INDIVIDUALS DESIGNATED BY AN ASTERISK (*) ONLY ATTENDED A MEETING AND DID NOT ACTIVELY PARTICIPATE IN VIOLENCE OR REVOLUTIONARY ACTIVITIES WERE NOT DISCUSSED.

Information reported on a card index by _____ on date _____

Remarks:

- (1) SD 170-512A - 144
- (2) 170-286 (Godfrey)

NOT
GERMANE

TO
Godfrey

Block Status

170-286-146

SEARCHED	INDEXED
SERIALIZED	FILED

10

Emp. 5
(7)

INFORMANT
SUBJECT: Whereabouts of Howard Barry Godfrey.

Recently the name of Barry Godfrey has been very much on the minds and lips of both left and right-wing extremists.

To begin with, Stanley McDade of Spring Valley claims to have seen Godfrey in Los Angeles on the night of September 8, 1973. His sighting is said to have occurred at a meeting of the National Socialist White People's Party in El Monte. This was the meeting at which Cliff Ward took over command of the NSWPP's Los Angeles headquarters from Joe Tommasi.

Ray Wilson, San Diego unit leader of NSWPP, tends to discount McDade's claim. Wilson said, "McDade is always coming up with wild stories and this is just one more of them".

A staff member of the pro-Communist San Diego Door claims to have succeeded in locating Godfrey in the Sacramento area. No more than that is known about the leftist attempt to find Godfrey.

Relating back to McDade's story, Gerald I. Smith of Santee has a theory. He believes that McDade may be sincere in what he says but that he mistook Mickey Wakefield of Escondido for being Barry Godfrey. Smith states that in his opinion, Godfrey and Wakefield are fairly similar in appearance.

Smith had more to say on the subject of FBI infiltration of left and right-wing extremist organizations. He said, "Actually it is a mistake to blame people like Godfrey for this situation. Even the individual FBI agents in the field are not really to blame. The informants and agents of the FBI are only doing what they are told. The ultimate blame lies with the dossier-gatherers back in Washington, D.C." Smith went on to say that he has nothing against the police for trying to be informed about the NSWPP and its opponents. He feels that the sole purpose of the police in doing this is to prevent trouble from starting. However, Smith feels that the attitude of Federal agents is less defensible. He said, "They (the FBI) seem to feel that groups like the NS should somehow be outlawed".

That is about all that is known about the current concern with Barry Godfrey and the most recent attitudes of Gerald Smith. Will

INFORMANT

(Mount Clipping In Space Below)

SAO'S HOOVER GETS REVERSAL

The man convicted of wounding former door staffer Paula Tharp while shooting into former economics professor Peter Bohmer's house, has had his conviction reversed by the Fourth District Court of Appeals.

George Mitchell Hoover, Secret Army Organization (SAO) member, was sentenced last February to from five years to life. His conviction was almost entirely due to the testimony of Howard Barry Godfrey, former SAO leader who later surfaced as an FBI informer. Godfrey was the driver of the car used in the shooting of Bohmer and Tharp's Ocean Beach home.

The Appeals Court ruled that Judge William Low's decision not to let the jury determine Godfrey's credibility (as both informer and accomplice) was in error. In addition, the court suggested that Godfrey's role in the shooting should have been grounds for prosecution. The fact that Godfrey was not charged at the time left few people who weren't at least a bit suspicious.

So George Hoover now goes back to Superior Court, where a jury will decide whether Godfrey's testimony was credible. And if they find it's not, a new trial might be ordered. All this would mean that Howard Barry Godfrey, who has been in relative hiding since the SAO trials, would return to San Diego to testify.

Meanwhile, sources inside the District Attorney's office say that they plan to appeal the conviction reversal.

(Indicate page, name of newspaper, city and state.)

SAN DIEGO D.S.
 11/8-22/73
 Volume 5 Issue

Date:
 Edition:
 Author:
 Editor:
 Title:

Character:

or

Classification:

Submitting Office:

Being Investigated

done 1/23/74
 Clark Spink
 make Xerox copy
 in 170-286

157-5017
 170-286-
 SEARCHED INDEXED
 SERIALIZED FILED
 NOV 13 1973
 FBI - SAN DIEGO
 12

Appeal Filed In Conviction Of Secret Army Key Figure

An appeal has been filed with the Fourth District Appellate Court, challenging the 1972 conviction of William Francis Yakopec, a key figure in the Secret Army Organization trials.

Yakopec, 31, was sentenced on Oct. 24, 1972, to one year to life in state prison after his Oct. 2 conviction on charges of assault with intent to commit murder, assault with a deadly weapon on a police officer, simple assault and possession of explosives.

The charges stemmed from an investigation of activities allegedly linked to the right-wing paramilitary Secret Army Organization, including the June 19, 1972 bombing of the Guild Theater, an adult movie house that showed sex-oriented films. No one was injured.

Yakopec, just before his sentencing, made a dramatic confession, saying he had lied on

the witness stand when he denied bombing the theater.

Fred Hetter, Yakopec's attorney, said he has appealed his client's conviction on grounds of errors in trial and in pretrial motions.

Hetter said he was wrongfully denied the right to suppress evidence on the basis that he was not allowed to question undercover policeman Rubien Brandon on affidavits in support of a search warrant for Yakopec's El Cajon residence.

Further, Hetter said, he was not allowed to question Brandon on the reliability of the key prosecution witness, Howard Barry Godfrey, a former San Diego city fireman who was a paid FBI informant assigned to infiltrate extremist right-wing groups.

Hetter said Godfrey's reliability as a witness was open to question because he had partic-

ipated in four felonies, involving the setting off of an incendiary device in his yard, and possession and sale of illegal explosives.

He said further that he had requested instructions from Superior Court Judge Robert W. Conyers, the trial judge, on entrapment, but his request was denied. Hetter added that Yakopec's case was one of entrapment.

On Yakopec's confession before sentencing, Hetter commented that it would be difficult to go to trial on the basis of a confession, and, if a new trial does develop, the defense would concentrate on the question of entrapment.

Yakopec was one of several persons indicted by the county grand jury in its investigation of Secret Army Organization activities. The series of trials that resulted captured wide public attention.

(Indicate page, name of newspaper, city and state.)

San Diego Union
9/26/73

Date:
Edition:
Author:
Editor:
Title:

Character:
or
Classification:
Submitting Office:
 Being Investigated

170-256
157-1825
170-486-144
SEP 26 1973
FBI - SAN DIEGO

*copy
made for
157-2815 (SAO)
170-286 (Godfrey)
EMJ*

(Mount Clipping in Space Below)

hard times....

Has the news media blackout in San Diego got you down? Well, it's got us down too. Last issue the DOOR ran a story about the activities of CREEP spy Donald Segretti in San Diego. The story was important enough for the *New York Times* (see below) to pick it up. In addition, it has been reprinted in the *Washington Post* and a number of other places.

All week the DOOR has been getting phone calls from around the country about our story. It has all been very rewarding — but also very frustrating. Here we are sitting on a major news story and with the exception of KGB — no San Diego news outlet has picked it up, or even called us to check the story out!!!

The DOOR will continue its investigation into San Diego's Watergate connections. And we will print whatever we find out! We hope that the other news media in San Diego will get off their asses and do some work. We will be glad to take them under our wing and give them a lead or two. In any event, you can read all about it right here in the DOOR.

We are reprinting the article from the *New York Times* so our readers can enjoy it along with us and so the sceptics can see that somebody takes us seriously.

(Indicate page, name of newspaper, city and state.)

SAN DIEGO DOOR

JULY 3-17

Vol 5 Issue 2

Date:

Edition:

Author:

Editor:

Title:

Character:

or

Classification:

Submitting Office:

Being Investigated

~~77~~-170-286

145

SEARCHED	INDEXED
SERIALIZED	FILED
JUL 3 1973	
FBI-SAN DIEGO	

F.B.I. Informer Is Linked To Right-Wing Violence

By STEVEN V. ROBERTS

Special to The New York Times

SAN DIEGO, June 23 — A leader of a right-wing, paramilitary organization that harassed young leftists here for more than a year says that the group was partly organized and financed by an informer for the Federal Bureau of Investigation. Law enforcement officers and others familiar with the situation corroborated his account.

The informer, Howard Berry Godfrey, participated in a shooting, as well as several fire-bombings and burglaries, while receiving regular payments from the F.B.I. for his services, it was said.

This account was provided this week by Jerry Lynn Davis, the former Southern California coordinator for the Secret Army Organization, a well-armed outgrowth of another right-wing group, the Minutemen.

Segretti Recognized

In another development this week, two members of the Secret Army Organization reportedly recognized a photograph of Donald H. Segretti, the young lawyer accused of organizing a Republican espionage campaign last year. According to *The Door*, a local radical newspaper, the two rightists identified the man in the photograph as "Donald Simms," whom they said they met in the summer of 1971 at a shooting range frequented by members of the Secret Army Organization.

The two men reportedly said that "Simms" was present at a discussion among the right-wingers about the Republican National Convention, originally scheduled to be held in San Diego last August before it was moved to Miami Beach. "Simms" did not participate in the discussion but an unidentified companion did, according to *The Door's* sources.

Mr. Segretti, who has been indicted for distributing false campaign literature in Florida, often used the name "Donald Simmons" in recruiting espionage agents.

It is also known that Mr. Segretti and the Secret Army Organization at different times, discussed the idea of abducting radicals who might disrupt the convention. But so far, there has been no firm evidence linking Mr. Segretti to the right-wing group.

Davis, a 31-year-old construction worker, spoke to a reporter after being released from prison. He said he had been held for possession of explosives on a charge of possession of explosives. The Secret Army Organization co-ordinator

had pleaded guilty and was granted probation.

According to Davis's account, the Secret Army Organization was formed in 1971 to train guerrillas who could organize a resistance movement should the United States be conquered by a foreign power. Howard Godfrey, the F.B.I. informer, was one of the six founding members and contributed the money used to print the group's recruiting literature, Davis said.

In addition, Godfrey was considered a "firebrand" within the organization and took a "more militant line" than most members, Davis said.

Godfrey told friends, and in some cases later testified in court, that he had participated in a series of violent actions against the rather small but vocal community of left-wing radicals in San Diego.

In one case, he admitted breaking into the offices of *The Street Journal*, a left-wing newspaper, and destroying printing equipment valued at several thousand dollars. In another case, he said he burglarized the Message Information Center, a counter-culture outpost, and stole their records.

Law enforcement agents say that Godfrey also performed several other burglaries and fire-bombed at least two cars belonging to radical sympathizers.

Agent Hid Gun

According to his own court testimony, Godfrey was riding in a car on Jan. 6, 1972, when another member of the Secret Army Organization fired a shot into a house occupied by young leftists. The bullet shattered the elbow of a girl named Paula Tharp. Miss Tharp and other residents of the house were planning demonstrations at the Republican convention.

Godfrey took the gun used in the shooting and gave it to his F.B.I. contact. The agent hid it under his couch for six months until the Secret Army Organization member who shot Miss Tharp was finally apprehended by the police. The incident cost the agent his job.

Given Godfrey's contributions to the Secret Army Organization in time and money, Davis said, "you might say that the S.A.O. was a federally funded anti-espionage program for the right wing."

Some commentators here believe that Davis is exaggerating Godfrey's role somewhat, but they agree that he was obviously a leader in the organization.

(Mount Clipping in Space Below)



Photo by Vince Compagnone

(Indicate page, name of newspaper, city and state.)

SAN DIEGO DOOR

July 3-17

Vol 15 / ISSUE 2

TRIALS

Bill Ritter

JERRY LYNN DAVIS

The former Southland coordinator for the Secret Army Organization (SAO) has been placed on three years probation. Superior Court Judge Franklin Orfield pronounced sentence last June 21 on Jerry Lynn Davis, former SAO chieftain who was found guilty of possessing inflammable material. Davis was originally charged with possessing explosive devices.

After spending a total of 134 days in jail (including a 90-day stint in Chino for a diagnostic study), Davis was given probation because of "good probation recommendations."

In an exclusive interview with the DOOR Davis and his attorney, Fred Hetter, said that they felt that the SAO had been used by the FBI. Through FBI informant [redacted] who [redacted] the FBI couldn't legally do themselves," Hetter told the DOOR.

This charge coincides with a DOOR investigation (see last issue) of illegal FBI and government activity in San Diego. In fact, FBI agents Peterson and Regnot visited Davis while he was in county jail awaiting sentencing. Davis told the DOOR that the FBI was investigating the activities of one Donald Simpson. Last issue, the DOOR revealed that CREEP agent Donald Segretti used the names Donald Simms and Donald Simmons

and that Segretti visited the Gunsmoke Ranch in El Cajon, a hangout for SAO members, in the summer of 1971. Davis, however, denied ever meeting anyone by the name of Donald Simms, Donald Simmons, Donald Simmons or Donald Simpson.

Davis did remember plans proposed by informer Godfrey to disrupt demonstrations by leftists at the Republic Convention when it was still slated for San Diego. Davis stated that Godfrey wanted to drop some kind of [redacted] on the demonstration sites; demonstrators.

Date:

Edition:

Author:

Editor:

Title:

Character:

or

Classification:

Submitting Office:

Being Investigated

170-286-142

SEARCHED _____	INDEXED _____
SERIALIZED _____	FILED _____
JUL 11 1971	
FBI-SAN DIEGO	

According to Davis, Godfrey hoped to provoke a riot and possibly a counter-riot by the police. The purpose of such a riot is unclear—except that it clearly would have helped Nixon.

The DOOR investigation has learned that there was a concentrated effort by CREEP, the FBI, and other governmental agencies to make sure that riots would disrupt the Republican FIASCO.

It appears that these plans were drawn up when it appeared that Senator Ed Muskie a serious threat, Nixon clearly would have blamed any violence on Muskie supporters. When it became apparent that McGovern had the nomination locked up and that the ITT scandal had forced the convention to move to Miami, the riot plans were clearly toned down. It is our theory that Nixon and his staff felt that they could easily beat McGovern.

Davis told us that he felt pretty much the same way and, in fact, was quick to point out the provocateur role Godfrey played. "Godfrey possessed explosives

for over 2 years," Davis said. Of course, Godfrey was never prosecuted for anything. The DOOR has learned that Godfrey is now writing a book about his experiences.

We are continuing our investigation into Watergate and the San Diego connections. If anyone has any information that might help us, give us a call. We will protect the identity of our sources.

Date 6/30/72

Title and Informant (170-286)

informant (170-286)

Date Property Acquired	Source From Which Property Acquired
6/30/72	informant
Location of Property or Bulky Exhibit	Reason for Retention of Property and Efforts Made to Dispose of Same
Firearms vault	Retain temporarily until disposition

Description of Property or Exhibit and Identity of Person to Whom Same

Submitted by SA EARL M. PETERSEN

- 1 - Browning Machine Gun, Caliber 50M2, US No. 32846 Mfg by Colts Patent Firearms Mfg. Co., Hartford, Conn. (This weapon completely in a disassembled condition. Barrel has been cut off by welding torch. Not in working condition)
- 1 .38 caliber silencer no brand name but with Pat. Pending and number 96 stamped on it. Blued steel.
- 1 - Sawed off shotgun barrel and stock (also sawed off) from Sears Roebuck model 226 100.100 shotgun. No serial number. Barrel 13 1/2 inches long.
- 2 Rifle grenade launchers. No identifying marks.

SEMIANNUAL INVENTORY CERTIFICATION TO JUSTIFY RETENTION OF PROPERTY (Initial and Date)

OCT 13 1972

MAR 27 1973

140

Field File # 170-286

SEARCHED INDEXED SERIALIZED FILED

UNITED STATES GOVERNMENT

Memorandum

TO : SAC (170-286)(B)

DATE: 2/26/73

FROM : SA Earl M. Petersen

SUBJECT: Howard Barry Godfrey
EM - SAO

This source has been discontinued in view of his testimony in SAO cases.

Case is being kept open for disposal of bulky exhibit after Forest trial due to start March 26, 1973.

Lead:

will dispose of bulky exhibit after Forest trial,

EMB: g
(1)

170-286-137

SEARCHED	INDEXED
SERIALIZED	FILED
FEB 28 1973	
FBI - SAN DIEGO	

[Handwritten signature]



UNITED STATES GOVERNMENT

Memorandum

TO : SAC (170-286)(P)

DATE: 12/28/72

FROM : SA EARL M. PETERSEN

SUBJECT: HOWARD BARRY GODFREY
FORMER EI

This case is being kept in a pending status until disposal of bulky exhibit in firearms vault and until end of case involving JERRY LYNN DAVIS, 157-3001, whose trial starts 1/15/72.

Some of the items in the vault will be forwarded to the Bureau and others will be returned to GODFREY.

GODFREY has been advised that inasmuch as no information was received from Bureau or Los Angeles regarding proposed individual to help him write a book that all was favorable or negative regarding him and that he could go ahead with his contact with him.

GODFREY will be in San Diego during the trial of DAVIS.

EMP:emp
(2)



POST P

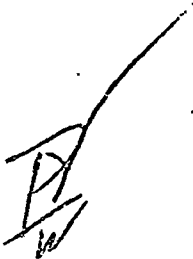

170-286-134

SEARCHED	INDEXED
SERIALIZED	FILED
DEC 26 1972	
FBI - SAN DIEGO	

1 W



Buy U.S. Savings Bonds Regularly on the Payroll Savings Plan

CITY San Diego, California

DATE November 6, 1972

Request of Special Agent in Charge, FBI, San Diego

One Hundred dollars, and No cents,

(\$ 100.00), which money is to be paid by me on 11/9/72¹⁴

to HOWARD BARRY GODFREY

for information concerning the case entitled SECRET ARMY ORGANIZATION; WILLIAM FRANCIS YAKOPEC; CALVIN FOX; GEORGE MITCHELL HOOVER.

Services: \$ 100.00 Federal Income Tax Withheld \$ _____

Expenses \$ _____

Signed: Earl M. Petersen
Special Agent

Have payments been made by other Offices? No Yes (List Offices below.)

Authority (date) Bulet 7-3-72

Period Covered by Payment 9/1/72 - 11/6/72

Authorization Checked mt

Check Number 18898

Receipts Received 11-14-72

Voucher Prepared 11-20-72 Item 26

Date of Actual Payment 11/9/72¹⁴

By whom SA EARL M. PETERSEN

Informant's File No. 170-286

Approved [Signature]
SAC

170-286-132
SEARCHED _____ INDEXED _____
SERIALIZED _____ FILED _____
NOV 20 1972
FBI-SAN DIEGO

Date 6/30/72

Title and INFORMANT (170-286)

INFORMANT (170-286)

Date Property Acquired <u>6/30/72</u>	Source From Which Property Acquired <u>INFORMANT</u>
--	---

Location of Property or Bulky Exhibit <u>Firearms vault</u>	Reason for Retention of Property and Efforts Made to Dispose of Same <u>Retain temporarily until disposition decided upon</u>
--	--

Description of Property or Exhibit and Identifying Characteristics Same

Submitted by SA CARL M. PETERSEN

- 1 - Browning Machine Gun, Caliber 50M2, US No. 32846 Mfg by Colts Patent Firearms Mfg. Co., Hartford, Conn. (This weapon completely in a disassembled condition. Barrel has been cut off by welding torch. Not in working condition)
- 1 .38 caliber silencer no brand name but with Pat. Pending and number 96 stamped on it. Blued steel.
- 1 - Sawed off shotgun barrel and stock (also sawed off) from Sears Roebuck model ~~100~~ 100.100 shotgun. No serial number. Barrel 13 1/4 inches long.
- 2 Rifle grenade launchers. No identifying marks.

SEMIANNUAL INVENTORY CERTIFICATION TO JUSTIFY RETENTION OF PROPERTY (Initial and Date)

OCT 13 1972 K

Field File # 170-286 131

SEARCHED.....INDEXED.....
SERIALIZED J FILED J

UNITED STATES GOVERNMENT

Memorandum

TO : SAC (170-286)

DATE: 11/15/72

FROM : SA *Earl in return*

- TE
- CI
- SI
- E
- PC
- PCI
- PSI
- E (Prob)
- E (Ghetto)

SUBJECT: *Howard Barry Mosley*

Dates of Contact

11/14, 15/72

File #s on which contacted (Use Titles if File #s not available or when CI provides positive information)

No negative contacts made

Purpose and results of contact

- NEGATIVE
- POSITIVE
- STATISTIC

See memo to files,

*tickler set to
cancel check 11/16/72*

170-286-130

Has informant shown any indication of emotional instability, unreliability or furnishing false information?

No

Informant certified that he has furnished all information obtained by him since last contact.

Coverage

Right wing

SEARCHED _____ INDEXED _____
SERIALIZED _____ FILED _____
NOV 25 1972
FBI - SAN DIEGO
1/2

PERSONAL DATA

*Emb. 9
(1)*

UNITED STATES GOVERNMENT

Memorandum

TO : SAC (170-286)

DATE: 10/31/72

FROM : SA Earl M. Peterson

- TE
- CI
- SI
- E
- PC
- PCI
- PSI
- E (Prob)
- E (Ghetto)

SUBJECT: Howard Barry Godfrey

Dates of Contact: 9/6/72, 9/12/72, 9/15/72, 9/25/72, 10/6/72, 10/11/72, 10/30/72

File #s on which contacted (Use Titles if File #s not available or when CI provides positive information)

NO NEGATIVE CONTACT MADE

Purpose and results of contact

NEGATIVE

POSITIVE

STATISTIC

See FD 302a on memo to files.

Has informant shown any indication of emotional instability, unreliability or furnishing false information? *No*

Informant certified that he has furnished all information obtained by him since last contact.

Coverage: *Right wing act.*

PERSONAL DATA

(Handwritten initials)

EM: 8
(1)

170-286-129

SEARCHED

SERIALIZED

FBI - SAN DIEGO

(Handwritten initials)

UNITED STATES GOVERNMENT

Memorandum

TO : SAC, SAN DIEGO (170-286)

DATE: 10/26/72

FROM : SA LAWRENCE F. WIRICK

SUBJECT: HOWARD BARRY GODFREY
FORMERLY INFORMANT

Re San Diego teletype to Bureau and Sacramento dated 10/26/72 and captioned SAO, Extremist Matters (SD file 157-2815).

On 10/26/72, Supervisor JAMES NEVES, Sacramento, was advised that GODFREY is currently working in the Office of Governor RONALD REAGAN and that he can be reached at telephone number 916-445-9837. There is no address for GODFREY. NEVES advised he would make arrangements to interview GODFREY by contacting him through above telephone number.

On 10/26/72, RICHARD HUFFMAN, Assistant District Attorney, County of San Diego, telephone number 236-2355, advised SA ARTHUR J. HOOPER that GODFREY could be located and contacted through above telephone number.

① - San Diego

LFW:ejt

(1) *ep*

170-286-128
SEARCHED *B*
SERIALIZED *B*
Michael A



Buy U.S. Savings Bonds Regularly on the Payroll Savings Plan

UNITED STATES GOVERNMENT

Memorandum

TO : SAC SAN Diego

DATE: 9-19-72

FROM : Inspector D.T. Sullivan

SUBJECT: -INFORMANT-

CI	PCI	TE	PC	GHETTO (PROB)
SI	PSI	EI	EI (PROB)	

137 -
134 -
170 - 286

The file pertaining to the above-captioned informant has been reviewed by the Inspection Staff, and the informant has been rated as:

- Excellent
- Very Good
- Good
- Fair
- Poor
- Insufficient Data to Rate

You are referred to the appropriate survey for instructions as to those informants rated "Poor." If rated "Fair," this matter should be followed closely by you for 90 days. Specific assignments should be given the informant during this period. If, at the end of 90 days, no positive improvement is shown, the file should be closed. The Bureau should be advised of the action taken as to those informants rated "Fair," i.e., were they closed out or did they become productive.

Remarks:

170-286-127

SEARCHED	INDEXED
SERIALIZED	FILED
SEP 23 1972	
FBI - SAN DIEGO	

Peterkin 191

San Diego

CITY _____

DATE September 6, 1972

Request of Special Agent in Charge, FBI, San Diego

One Hundred and Fifty dollars, and No cents,

(\$ 150.00), which money is to be paid by me on 9/6/72

to HOWARD BARRY GODFREY INFORMANT

for information concerning the case entitled SECRET ARMY ORGANIZATION, NATIONAL SOCIALIST WHITE PEOPLES PARTY, MINUTEMEN, AND INDIVIDUALS

IN THESE ORGANIZATIONS.

Services: \$ 150.00 Federal Income Tax Withheld. \$ _____

Expenses \$ None

Signed: Earl M. Petersen
Special Agent

Have payments been made by other Offices? No Yes (List Offices below.)

Authority (date) Bulet 7-3-72

Period Covered by Payment 8/1-31/72

Authorization Checked mt

Check Number 18672

Receipts Received 9-6-72

Voucher Prepared 9-14-72 Item 5

Date of Actual Payment 9/6/72

By whom SA EARL M. PETERSEN

Informant's File No. 170-286

Approved [Signature]
SAC

170-286-121
SEARCHED _____ INDEXED _____
SERIALIZED _____ FILED _____
SEP 11 1972
FBI-SAN DIEGO

SAC (174-531)(170-286)

8/28/72

SA EARL M. PETERSEN

WILLIAM FRANCIS YAKOPEC
BOMBING OF GUILD MOVIE THEATRE
EID

Re my memo to file 7/12/72.

On this date Sgt. WILLIAM BIRCH, 70th Ord. Detachment, Fort Rosecrans, California was advised that the remaining items stored with the 70 th Ord. Det. on July 6, 1972, can be destroyed.

The following items are involved:

- 1 M201A1 CS Grenade
- 5 Practise mine fuses
- 1 Hand grenade fuze.

It is noted that the following items were turned over to Detective Rubien Brandon on about 7/12/72 by the 70th Ord. Det.:

- 100 feet commercial time fuze
- 4 ½ pound blocks TNT
- 44 M1 fuze igniters

EMP:emp
(2)

6

Mr. Blackburn
destroy trash
113

170-286-125

SEARCHED	INDEXED
SERIALIZED	FILED
AUG 28 1972	
FBI - SAN DIEGO	

Wife Of SAO Suspect Also Cited By Court

An investigation of activities allegedly linked to a Secret Army Organization group here has resulted in a charge against the wife of a key defendant.

She is Deborah Yakopec, 26, who pleaded innocent yesterday to possession of explosives when arraigned before Municipal Court Judge Earl B. Gilliam.

Mrs. Yakopec is the wife of William Francis Yakopec, 30, of 722 Graves Ave., El Cajon, who was indicted by the county grand jury several weeks ago on charges of attempted murder, assault with a deadly weapon on a police officer and possession of explosives. He was arrested June 26 and is being held in lieu of \$50,000 bail.

Gilliam yesterday set 1:15 p.m. Sept. 5 as the time for a preliminary hearing for Mrs. Yakopec. A hearing also is

scheduled at that time for her husband on an additional charge of possession of explosives. He pleaded innocent to the count Monday.

The new charge against Yakopec and the charge against his wife stem from another search of their home by San Diego police, according to Fred Hetter, the couple's attorney. The search was made Aug. 9, he said.

Deputy Dist. Atty. Richard Neely said an incendiary paraffin illumination grenade and a detonator device were confiscated in the search.

Hetter said he plans to file charges of false arrest in both cases. He said no one was at the Yakopec home at the time of the Aug. 9 search. He said Yakopec has been held in county jail since June 27 and his wife left their home with her two children two days later. He said she has been staying in

(Continued on B-4, Col. 3)

SAO Bombing Suspect's Wife Cited By Court

(Continued)

Santa Ana because of harassment.

When asked about the harassment, Hetter said "van-type" vehicles had been cruising slowly around the Yakopec home.

Gilliam released Mrs. Yakopec in her own recognizance yesterday.

The charges against her husband stem from the June 19 bombing of the Guild Theater, 3227 Fifth Ave., an adult movie house. No one was injured.

Mrs. Yakopec was the ninth person charged in connection with the investigation of the SAO, which has been described as an extremist paramilitary organization. A key figure in the case is Howard Berry Godfrey, a San Diego fireman who has been identified as an FBI informant in the investigation.

In a new development yesterday, Hetter said he would make a motion in Superior Court Friday "for a psychiatric examination of a complaining witness and informant (Godfrey)..."

Hetter said his client, Yakopec, is charged in connection with the Guild Theater bombing.

He said Godfrey is "the only witness before the grand jury who linked the defendant with the bombing."

SAN DIEGO Cir
8/23/72

1-157-NEW (DEBORAH YAKOPEC)
 ①-170-286 (GODFREY)
 1-170- (William YAKOPEC)
 1-170-2815 (SAO)

EM 8

170-286-124

SEARCHED	INDEXED
SERIALIZED	FILED
AUG 23 1972	
FBI - SAN DIEGO	

UNITED STATES GOVERNMENT

Memorandum

TO : SAC (170-256)(B)

DATE: 8/28/72

FROM : SA Emil M. Peterson

- TE
- CI
- SI
- E ~~Foreign~~
- PC
- PCI
- PSI
- E (Prob)
- E (Ghetto)

SUBJECT: Howard Barry Golfray
Former INFORMANT

Dates of Contact
8/23/72 8/28/72

File #s on which contacted (Use Titles if File #s not available or when CI provides positive information)

157-2815 (SAO)

Purpose and results of contact

NEGATIVE

POSITIVE

STATISTIC

Info Channelized

170-256-123

Has informant shown any indication of emotional instability, unreliability or furnishing false information?

No

Informant certified that he has furnished all information obtained by him since last contact.

Coverage

Right wing

PERSONAL DATA

SEARCHED INDEXED
SERIALIZED FILED

AUG 28 1972

FBI - SAN DIEGO

EMB: P

(Handwritten initials)

A

CITY San Diego

DATE August 1, 1972

Request of Assistant Special Agent in Charge, FBI, San Diego

~~Three hundred fifty~~ dollars, and No cents,

(\$ 350.00), which money is to be paid by me on 8/2/72

to Informant

for information concerning the case entitled ~~SECRET ARMY ORGANIZATION and NATIONAL SOCIALIST WHITE PEOPLES PARTY and individual members.~~

Services: \$ 250.00 Federal Income Tax Withheld \$ _____

Expenses \$ 100.00
Total 350.00

Signed: Earl M. Petersen
Special Agent

Authority (date) Bulet 7-3-72

Period Covered by Payment July 1 - 31/72

Authorization Checked mt

Check Number 18552

Receipts Received 8-2-72

Voucher Prepared 8-7-72 Item 24

Date of Actual Payment 8/3/72

By whom SA EARL M. PETERSEN

Informant's File No. 170-286

170-286-119

Approved [Signature] SAC

SEARCHED _____ INDEXED _____
SERIALIZED _____ FILED _____
AUG 1 1972
FBI - SAN DIEGO

UNITED STATES GOVERNMENT

Memorandum

TO : SAC (170-286)

DATE: 7/31/72

FROM : SA EARL M. PETERSEN

- TE
- CI
- SI
- E
- PC
- PCI
- PSI
- E (Prob)
- E (Ghetto)

SUBJECT: Informant

Dates of Contact

DAILY Most Recent 7/31/72

File #s on which contacted (Use Titles if File #s not available or when CI provides positive information)

Purpose and results of contact

- NEGATIVE
- POSITIVE
- STATISTIC

Channelized

Has informant shown any indication of emotional instability, unreliability or furnishing false information? *NO*

170-286-118

Informant certified that he has furnished all information obtained by him since last contact.

Coverage

Right wing

PERSONAL DATA

(Signature)

SEARCHED _____
 SERIALIZED _____
 JUL 31 1972
 FBI - SAN DIEGO
IV

*EMP: 8
(1)*

SAC (174-531)

7/12/72

SA EARL M. PETERSEN

WILLIAM FRANCIS YAKOPEC,
BOMBING OF GUILD MOVIE THEATRE
EID

Attached for the file is a xerox copy of receipt for items stored with the 70th Ord. Detachment, Fort Rosecrans, California. These items received from on 6/30/72.

informant

Original of receipt placed in 174-531, 1A.

Source has advised that these items can be destroyed. Detective Ruben Brandon, SDPD has indicated that the blocks of TNT may be of interest as they are military explosives and came from JERRY LYNN DAVIS. Information re receipt of this information and items subject of separate communication.

Destruction of explosive items will be handled in sources file 170-286.

① - 170-286

EMP:emp

(2)

Detective Ruben Brandon advised today that he needs 4 1/2 lb blocks of TNT, time fuse & dynamite. He will get them & place in police. Blackburn - EMP

Mrs Blackburn set tickler for 7/24/72 for advising 70th Ordnance that explosives can be destroyed unless needed by SDPD.

Mrs Blackburn *Carol* *AKS*

170-286-115

SEARCHED	INDEXED
SERIALIZED	FILED
JUL 1 1972	
FBI - SAN DIEGO	



DEPARTMENT OF THE ARMY
70TH ORDNANCE DETACHMENT (EOD)
ROSECRANS, SAN DIEGO, CALIFORNIA 92106

6 July 1972

The 70th Ord Det (EOD) received the below listed items from Agent Petersen, FBI, to be held for a period of app. two weeks, or to destroy these items later.

- 1 ea. M201A1 CS Grenade
- 10 ea. Comm. time fuze
- 4 ea. 1/2 lb. blocks TNT
- 5 ea. mine fuze, practice
- 1 ea. hand grenade fuze
- 44 ea. M1 fuze igniters

*To Destroyer Division
SDPD 7/12/72*

James O. Barnett
JAMES O. BARNETT
2LT OrdC
Commanding

Earl M. Petersen

Agent Petersen
FBI

Original in 174-⁵⁸¹351 1A

*Sgt. [unclear]
70th Ord Det
destroyed remaining
items 8/25/72*

CITY San Diego, California

DATE July 10, 1972

Request of Special Agent in Charge, FBI, San Diego

Two hundred dollars, and No cents,

(\$ 200.00), which money is to be paid by me on 7/10/72

informant

to _____

for information concerning the case entitled WILLIAM FRANCIS YAKOPKE, BOMBING OF GUILD MOVIE THEATER, THREE EIGHT TWO SEVEN - 5th AVENUE, SAN DIEGO, JUNE 19, 1972. EID.

Services: \$ None

Federal Income Tax Withheld \$ _____

Expenses \$ \$200.00

Signed: _____

Earl M. Petersen

Special Agent

Authority (date) Bureau teletype 7/3/72

Period Covered by Payment --

Authorization Checked mt

Check Number 18476

Receipts Received 7-13-72

Voucher Prepared 7-19-72 Item 2

Date of Actual Payment 7/10/72

By whom SA EARL M. PETERSEN

Informant's File No. 170-286

Approved W JPS SAC

170-286-114
SEARCHED _____ INDEXED _____
SERIALIZED _____ FILED _____
JUL 11 1972
FBI-SAN DIEGO

CITY San Diego, California

DATE June 14, 1972

Request of Special Agent in Charge, FBI, San Diego

Two Hundred and Fortytwo dollars, and Nineteen----- cents,

(\$ 242.19), which money is to be paid by me on 6/14/72

to informant

for information concerning the case entitled Secret Army Organization; JERRY

LYNN DAVIS; JAMES EVAN POTO; DONALD WILLIAM CARRIE; CALVIN

HENDELL FOX.

Expenses incurred in use of personal automobile, postage, purchase of miscellaneous items, etc.

Services: \$ 215.00

Federal Income Tax Withheld \$ _____

Expenses \$ 27.19

Signed: _____

Special Agent

Have payments been made by other Offices? No Yes (List Offices below.)

Authority (date) Bulet 1/4/72

Period Covered by Payment 5/1 - 31/72

Authorization Checked unt

Check Number 18390

Receipts Received 6-21-72

Voucher Prepared 6-23-72 Item 2

Date of Actual Payment 6/14/72

By whom SA STEVEN L. CHRISTENSEN

Informant's File No. 170-286

Approved [Signature] SAC

170-286-113

SEARCHED _____	INDEXED _____
SERIALIZED _____	FILED _____
JUN 1972	
FBI - SAN DIEGO	

113

CITY San Diego, California
DATE July 10, 1972

Request of Special Agent in Charge, FBI, San Diego

Three hundred and fifty dollars, and no cents,

(\$ 350.00), which money is to be paid by me on July 10, 1972

to informant

for information concerning the case entitled Secret Army Organization, JERRY LYNN DAVIS, CALVIN HENDRELL FOX, WILLIAM FRANCIS YAKOPEC, GEORGE HOOVER, RICHARD FLEURY, GENEVIEVE FLEURY.

Services: \$ 250.00 Federal Income Tax Withheld \$ _____

Expenses \$ 100.00*
Total \$ 350.00

*Actual expense was \$101.05 Signed: Earl M. Petersen
Special Agent

Authority (date) Bulet 1144/72 7/31/72

Period Covered by Payment 6/1-30/72

Authorization Checked mt

Check Number 18477

Receipts Received 7-11-72

Voucher Prepared 7-14-72 Item 16

Date of Actual Payment 7/10/72

By whom SA EARL M. PETERSEN

Informant's File No. 170-286

Approved [Signature]
SAC

170-286-112
SEARCHED _____ INDEXED _____
SERIALIZED _____ FILED _____
JUL 11 1972
FBI-SAN DIEGO

UNITED STATES GOVERNMENT

Memorandum

TO : SAC *San Diego (170-286)*

FROM : SA *Steven L. Christensen*

SUBJECT: *Informant*

DATE: *5/31/72*

- TE
- CI
- SI
- E
- PC
- PCI
- PSI
- E (Prob)
- E (Ghetto)

Dates of Contact

Contact several times weekly during April + May, 1972

File #s on which contacted (Use Titles if File #s not available or when CI provides positive information)

157-2815

157-28

157-3001

157-3017

157-3170

157-3169

Purpose and results of contact

- NEGATIVE
- POSITIVE
- STATISTIC

Info to files by "C" memo.

FORM O-1

FILE # *170-286*

DATE RECEIVED *6/15/72*

DATE RETURNED _____

BY _____

Has informant shown any indication of emotional instability, unreliability or furnishing false information? *NO*

170-286-100

Informant certified that he has furnished all information obtained by him since last contact.

Coverage

Extremist

PERSONAL DATA

SEARCHED	INDEXED
SERIALIZED	FILED
JUN - 6 1972	
FBI - SAN DIEGO	

CITY San Diego, California

DATE May 11, 1972

Request of Special Agent in Charge, FBI, San Diego

~~Two Hundred and Thirtysix~~ dollars, and ~~Seventy~~ cents,

(\$ ~~236.70~~), which money is to be paid by me on May 11, 1972

to informant

for information concerning the case entitled Secret Army Organization; National Socialist White People's Party; JERRY LYNN DAVIS; GERALD LEE SMITH; CALREP.

~~Expenses incurred in use of personal automobile, telephone calls, postage, etc.~~

Services: \$ 220.00

Federal Income Tax Withheld \$ _____

Expenses \$ 16.70

Signed:

Steven L. Christensen
Special Agent

Have payments been made by other Offices? No Yes (List Offices below.)

Authority (date) Bulet 1/11/72

Period Covered by Payment Services 4/1-30/72; Expenses 4/15-30/72.

Authorization Checked Ynt

Check Number 18290

Receipts Received 5-17-72

Voucher Prepared 5-25-72 Item 3

Date of Actual Payment 5/12/72

By whom SA STEVEN L. CHRISTENSEN

Informant's File No. 170-286

Ch Approved _____ SAC

170-286-99
SEARCHED _____ INDEXED _____
SERIALIZED 1 FILED 12
MAY 1972
FBI-SAN DIEGO

CITY San Diego, California

DATE May 11, 1972

Request of Special Agent in Charge, FBI, San Diego

~~Two Hundred and Thirtysix~~ dollars, and ~~Seventy~~ cents,

(\$ 236.70), which money is to be paid by me on May 12, 1972

to SD 1155 - E

for information concerning the case entitled Secret Army Organization; National

Socialist White People's Party; JERRY LYNN DAVIS; GERALD LEE

SMITH; CALREP.

~~Expenses incurred in use of personal automobile, telephone calls,~~
postage, etc.

Services: \$ 220.00

Federal Income Tax Withheld \$ _____

Expenses \$ 16.70

Signed: Steven L. Christensen
Special Agent

Have payments been made by other Offices? No Yes (List Offices below.)

Authority (date) Bulet 1/4/72

Period Covered by Payment Services 4/1-30/72; Expenses 4/15-30/72.

Authorization Checked ymt

Check Number 18290

Receipts Received 5-17-72

Voucher Prepared 5-25-72 Item 3

Date of Actual Payment 5/12/72

By whom SA STEVEN L. CHRISTENSEN

Informant's File No. 170-286

CM Approved _____ SAC

170-286-99
SEARCHED _____ INDEXED _____
SERIALIZED 13 FILED 12
MAY 2 1972
FBI-SAN DIEGO

CITY San Diego, California

DATE April 14, 1972

Request of Special Agent in Charge, FBI, San Diego

~~Thirtysix~~ dollars, and ~~no~~ cents,

(\$ 36.00), which money is to be paid by me on April 14, 1972

to informant

for information concerning the case entitled Secret Army Organization. Expenses
for special assessment and postage in connection with production
of most recent organizational bulletin.

Services: \$ 0.00

Federal Income Tax Withheld \$ 0.00

Expenses \$ 36.00

Signed: Steven L. Christensen
Special Agent

Have payments been made by other Offices? No Yes (List Offices below.)

Authority (date) Bulet. 1/11/72

Period Covered by Payment 4/1 to 4/14/72

Authorization Checked mt

Check Number 18201

Receipts Received 5-8-72

Voucher Prepared 5-12-72 Item 2

Date of Actual Payment 4/14/72

By whom SA STEVEN L. CHRISTENSEN

Informant's File No. 170-286

Approved [Signature]
SAC

170-286-98
SEARCHED _____ INDEXED _____
SERIALIZED 7 FILED 12
MAY 2 1972
FBI-SAN DIEGO

CITY San Diego, California

DATE April 4, 1972

Request of Special Agent in Charge, FBI, San Diego

~~Two Hundred and Thirtysix~~ dollars, and ~~forty~~ cents,

(\$ 236.40), which money is to be paid by me on April 4, 1972

to - informant

for information concerning the case entitled Secret Army Organization; JERRY LYNN DAVIS; CY ANDERSON; RONALD MICHAEL ZARICK; GEORGE M. HOOVER; National Socialist White People's Party; GERALD LEE SMITH; LARAY D. WILSON. Expenses incurred in use of personal automobile, postage, telephone calls, and miscellaneous purchases.

Services: \$ 205.00

Federal Income Tax Withheld \$ None

Expenses \$ 31.40

Signed: Steven L. Christensen
Special Agent

Have payments been made by other Offices? No Yes (List Offices below.)

Authority (date) Bulet 1/11/72

Period Covered by Payment 3/1 - 31/72

Authorization Checked snab

Check Number 18160

Receipts Received 4/7/72

Voucher Prepared Item 12

Date of Actual Payment 4/7/72

By whom SA STEVEN L. CHRISTENSEN

Informant's File No. 170-286

Approved [Signature]
SAC

170-286-97
SEARCHED _____ INDEXED _____
SERIALIZED _____ FILED _____
APR 11 1972
FBI - SAN DIEGO

UNITED STATES GOVERNMENT

Memorandum

TO : SAC *San Diego (170-286)*

DATE: *3/31/72*

FROM : SA *Steven L. Christensen*

- TE
- CI
- SI
- E
- PC
- PCI
- PSI
- E (Prob)
- E (Ghetto)

SUBJECT: *informant*

Dates of Contact
Contact several times weekly during February + March 1972

- File #s on which contacted (Use Titles if File #s not available or when CI provides positive information)
- 157-2815*
 - 157-28*
 - 157-3007*
 - 157-3017*
 - 157-201 + others*

Purpose and results of contact

- NEGATIVE
- POSITIVE
- STATISTIC

Info in "C" memos

Has informant shown any indication of emotional instability, unreliability or furnishing false information? *No* *170-286-96*

Informant certified that he has furnished all information obtained by him since last contact.

Coverage
Extensive

PERSONAL DATA

SEARCHED INDEXED
SERIALIZED FILED
APR 1 1972
FBI - SAN DIEGO

CITY San Diego, California

DATE March 6, 1972

Request of Special Agent in Charge, FBI, San Diego

Two Hundred and five dollars, and no----- cents,

(\$ 205.00), which money is to be paid by me on March 6¹⁴, 1972

to INFORMANT

for information concerning the case entitled Secret Army Organization; National Socialist White Peoples Party; JERRY LYNN DAVIS; GEORGE HOOVER; FRANK UACOPEC; ROBERT MAYER.

Services: \$ 205.00 Federal Income Tax Withheld \$ _____

Expenses \$ _____

Signed: Steven L. Christensen
Special Agent

Have payments been made by other Offices? No Yes (List Offices below.)

Authority (date) Bulet 1/4/72

Period Covered by Payment 2/1 to 29/72

Authorization Checked OK

Check Number 18055

Receipts Received 3/14/72

Voucher Prepared 3/17/72 Item 11

Date of Actual Payment 3/18/72

By whom SA STEVEN L. CHRISTENSEN

Informant's File No. 170-236

Approved [Signature]
SAC

170-256-95
SEARCHED _____ INDEXED _____
SERIALIZED JD FILED FB
MAR 17 1972
FBI - SAN DIEGO

CITY San Diego, California

DATE February, 16, 1972

Request of Special Agent in Charge, FBI, San Diego

Fifty----- dollars, and no----- cents,

(\$ 50.00), which money is to be paid by me on February 18, 1972

to informant

for information concerning the case entitled JERRY LYNN DAVIS; Secret Army Organization. Money expended in transportation and purchases incurred in providing coverage of these cases.

Services: \$ ----- Federal Income Tax Withheld \$ -----

Expenses \$ 50.00

Signed: Steven L. Christensen
Special Agent

Have payments been made by other Offices? No Yes (List Offices below.)

Authority (date) Bulet 1/11/72

Period Covered by Payment 2/1/72 - 2/15/72

Authorization Checked mal

Check Number 17991

Receipts Received 2/18/72

Check Prepared 2/28/72 Item 9

Date of Actual Payment 2/18/72

By whom SA STEVEN L. CHRISTENSEN

Requestant's File No. 170-286

Approved [Signature]
SAC

170-286-94
SEARCHED INDEXED
SERIALIZED FILED
FEB 28 1972
FBI - SAN DIEGO

CITY San Diego, California

DATE January 28, 1972

Assistant Request of Special Agent in Charge, FBI, San Diego

Two Hundred and Fortytwo dollars, and Forty-- cents,

(\$ 242.40), which money is to be paid by me on 2/1/72 ~~January 31, 1972~~

to INFORMANT

for information concerning the case entitled Secret Army Organization; National Socialist White Peoples Party; The Ocean Beach Collective; JERRY LYNN DAVIS; RON ZARICK; ROBERT S. MAYER.

Expenses were incurred in use of personal automobile, postage, tele- phone calls and other miscellaneous purchases.

Services: \$ 220.00 Federal Income Tax Withheld \$ _____

Expenses \$ 22.40

Signed: Steven L. Christensen
Special Agent

Have payments been made by other Offices? No Yes (List Offices below.)

Authority (date) Bulet to S.D. 1/4/72

Period Covered by Payment 1/1 - 31/72

Authorization Checked CRB

Check Number 102921

Receipts Received 2/1/72

Voucher Prepared 2/4/72 Item 12

Date of Actual Payment 2/27/72 2/1/72

By whom SA STEVEN L. CHRISTENSEN

Informant's File No. 170-286

Approved _____ SAC

170-286-93
SERIALIZED FILED
FBI - SAN DIEGO

UNITED STATES GOVERNMENT

Memorandum

TO : SAC, San Diego (170-286) DATE: 1/31/72

FROM : SA Steven L. Christensen

- TE
- CI
- SI
- E
- PC
- PCI
- PSI
- E (Prob)
- E (Ghetto)

SUBJECT: informant

Dates of Contact

Several times weekly during November, December, Jan

File #s on which contacted (Use Titles if File #s not available or when CI provides positive information)

- 157-1798
- 157-28
- 100-14297
- 100-14273

Purpose and results of contact

- NEGATIVE
- POSITIVE
- STATISTIC

Info disseminated by "C" memo.

Has informant shown any indication of emotional instability, unreliability or furnishing false information? No

170-286-92

Informant certified that he has furnished all information obtained by him since last contact.

Coverage
Retention Material

PERSONAL DATA

SEARCHED _____ INDEXED _____
SERIALIZED _____ FILED _____
JAN 31 1972
FBI - SAN DIEGO
W

CITY San Diego, California

DATE January 10, 1972

Request of Special Agent in Charge, FBI, San Diego

~~Two Hundred and Fiftythree~~ dollars, and ~~Seventyfive~~ cents,

(\$ 253.75), which money is to be paid by me on January 1³, 1972

to informant

for information concerning the case entitled Minuteman Organization; Secret Army Organization; National Socialist White People's Party; White Power Information Center; JERRY LYNN DAVIS; STANLEY DON MCDADE; GEORGE HOOVER; JAMES EVAN POTO; B ETTIE HAUGHTON.

Services: \$ 215.00

Federal Income Tax Withheld \$ _____

Expenses \$ 38.75

Signed: Steven L. Christensen
Special Agent

Authority (date) 1/1/72 Bulet _____

Period Covered by Payment 12/1 - 31/71

Authorization Checked [Signature]

Check Number 17860

Receipts Received 1/13/72

Voucher Prepared 1/17/72 Item 8

Date of Actual Payment 1/18/72

By whom SA STEVEN L. CHRISTENSEN

Informant's File No. 170-286

170-286-91
SEARCHED [initials]
SERIALIZED [initials]
INDEXED [initials]
FILED [initials]

Approved [Signature]
SAC

UNITED STATES GOVERNMENT

Memorandum

TO : SAC, SAN DIEGO (170-236)

DATE: 1/13/72

FROM : SA STEVEN L. CHRISTENSEN

SUBJECT: *informant*
EM - MM

On 1/12/72 Informant was contacted by writer at which time he furnished the following information.

Recently the Secret Army Organization prepared and distributed a special bulletin regarding PETER GEORGE BOHMER. Response from Right Wing sympathizers to this bulletin has been very encouraging and consequently, on 1/6/72, source was given an assignment by JERRY LYNN DAVIS, leader of the SAO, to conduct a surveillance of the residence of BOHMER at 5155 Muir, Ocean Beach, for the purpose of obtaining additional intelligence information, such as license plate numbers and descriptions of occupants. ~~_____~~
This information was to be used in the preparation of a future intelligence bulletin of the SAO.

In order to avoid going on this assignment alone, source contacted GEORGE M. HOOVER, an associate of members of the SAO, and requested that he accompany source. Source and HOOVER arrived in the vicinity of BOHMER's residence at about 8:45 PM that evening, watched the house for a period of time, ~~_____~~
~~_____~~ went so far as to place ~~_____~~ an SAO sticker on the front door of the house. Informant advised that at no time did he see anyone enter ~~_____~~ the house, and both he and HOOVER assumed the house to have been unoccupied ~~_____~~ afterwards.

Source advised that prior to going home he drove by the house one last time. He said that HOOVER, who always has one or more pistols with him at all times, made a statement about the house, exact nature unrecalled, pointed a pistol out the passenger window of the car, and fired two shots at the house. Source advised that fortunately the pistol, an automatic, jammed on the third shot or he feels certain HOOVER would have emptied the clip in the gun. Source said he then yelled at HOOVER "What ~~do~~ *do* ~~you~~ *think you're* doing?", and then ~~_____~~ the area as quickly as possible.

determined there were no cars which could be associated with the house

But did find two papers found

1 - SD 170-236
SLC/slc
(1)

ABOVE EXCISIONS WERE
IN ORIGINAL MATERIAL

170-236-90

SEARCHED	INDEXED
SERIALIZED	FILED
JAN 1 1972	
FBI - SAN DIEGO	

It is noted that ~~that source~~ that source drives a 1939 Rambler American, medium blue, which would generally match the description of the shooting vehicle as previously furnished to the police. Source has explained that he was reluctant to discuss this matter in its entirety ~~in previous telephonic contacts with writer~~ ~~as~~ as ~~his~~ wife was present at the time and he did not wish to upset her unnecessarily. He stated that the incident had come as a complete surprise to him, and that he had no intention or desire to take any action at BOHNER's residence other than to obtain whatever information was available in as discreet a manner as possible. He said he is extremely upset and dismayed at the turn of events and would like to end his association with these individuals, but, as before, could see no practical way of doing so at this time.

It is noted that Informant has been repeatedly cautioned, on previous occasions to avoid becoming directly involved in any activities which might result in personal injury or death for any individual. Source has wholeheartedly agreed with this and has consistently furnished all information in his possession regarding the possibility of such incidents occurring. Writer believes that source was totally unaware that HOOVER might shoot into the house before the incident happened. ~~Source has been advised to avoid all future contact with HOOVER, as much as possible, and has agreed that this would appear to be the best course of action. He advised that to the best of his knowledge, only he and HOOVER are presently aware of the incident. He said it is his understanding the gun involved has been permanently disposed of. Source pointed out that the incident appears to have caused HOOVER to become quite "fired up" and to be ready for a violent confrontation with the police if he should be approached on the matter. Source said he doubts HOOVER will discuss the matter with anyone else but cannot be sure of this. He said that HOOVER has never been interviewed before by law enforcement and would advise against such an interview in view of his unpredictability.~~

To his knowledge,

ABOVE EXCISIONS WERE IN ORIGINAL MATERIAL

CITY San Diego, California

DATE November 26, 1971

Request of Special Agent in Charge, FBI, San Diego

~~Two Hundred and Fortyseven~~ dollars, and ~~Fifty~~ cents,

(\$ 247.50), which money is to be paid by me on November 30, 1971

to informant

for information concerning the case entitled Minuteman Organization; Secret

Army Organization; JERRY LYNN DAVIS; GEORGE HOOVER; FRANK

YOCOPEC; PETER RUPLINGER.

~~Expenses incurred in use of personal automobile, telephone calls, postage, and purchase of miscellaneous supplies.~~

Services: \$ 220.00

Federal Income Tax Withheld \$ _____

Expenses \$ 27.50

Signed: Steven L. Christensen
Special Agent

Authority (date) Bulet 6/10/71

Period Covered by Payment 11/1 - 30/71

Authorization Checked ceh

Check Number 17745

Receipts Received 12/1/71

Voucher Prepared 12/7/71

Date of Actual Payment 11/30/71

By whom SA STEVEN L. CHRISTENSEN

Informant's File No. 170-286

Approved [Signature] SAC

FORM 01 - Trait for
170-286 12/30/71
FILE #
DATE RECEIVED 12/21/71
DATE RECEIVED 12-21
BY: 12-27
[Signature]

170-286-861
SEARCHED _____ INDEXED _____
SERIALIZED 7 FILED 1
DEC 21 1971
FBI - SAN DIEGO

UNITED STATES GOVERNMENT

Memorandum

TO : SAC *San Diego (170-286)* DATE: *11/30/71*

FROM : SA *Steven L. Christensen* TE CI SI E
 PC PCI PSI E (Prob)
 E (Ghetto)

SUBJECT: *informant*

Dates of Contact
Several contacts weekly during October + November 1971.

File #s on which contacted (Use Titles if File #s not available or when CI provides positive information)

Purpose and results of contact

NEGATIVE
 POSITIVE
 STATISTIC

Info disseminated to files by "C" crews.

170-286-86A

Has informant shown any indication of emotional instability, unreliability or furnishing false information? - *No*

Informant certified that he has furnished all information obtained by him since last contact. Coverage *Extremist Matters*

PERSONAL DATA

(Pl)
A

SEARCHED	INDEXED
SERIALIZED	FILED
FBI - SAN DIEGO	

CITY San Diego, California

DATE October 29, 1971

Request of Special Agent in Charge, FBI, San Diego

Two Hundred and Thirtyone dollars, and Forty--- cents,

(\$ 231.40), which money is to be paid by me on October 29, 1971

to informant

for information concerning the case entitled: Minuteman Organization; JERRY LYNN DAVIS; Secret Army Organization; JAMES EVAN POTO; CY ANDERSON. Expenses were incurred in use of personal automobile, postage, telephone calls, and purchase of miscellaneous items.

Services: \$ 210.00

Federal Income Tax Withheld \$ _____

Expenses \$ 21.40

Signed: Steven L. Christensen
Special Agent

Have payments been made by other Offices? No Yes (List Offices below.)

Authority (date) Bulet 6/10/71

Period Covered by Payment 10/1 - 29/71

Authorization Checked male

Check Number 17669

Receipts Received 11/4/71

Voucher Prepared 11/9/71 Item 18

Date of Actual Payment 10/29/71

By whom SA STEVEN L. CHRISTENSEN

Informant's File No. 170-286

Approved [Signature]

170-286-86
SEARCHED _____ INDEXED _____
SERIALIZED 4 FILED 1
NOV 9 1971
FBI - SAN DIEGO

Memorandum

TO : SAC

FROM : Inspector Thomas W. Kitchens

DATE: 10/22/71

SUBJECT: ~~REDACTED~~ INFORMANT

CI PCI TE PC GHETTO (PROB) 137 -
SI PSI EI EI (PROB) 134 -
170 - 286

The file pertaining to the above-captioned informant has been reviewed by the Inspection Staff, and the informant has been rated as:

- Excellent
- Very Good
- Good
- Fair
- Poor
- Insufficient Data to Rate

You are referred to the appropriate survey for instructions as to those informants rated "Poor." If rated "Fair," this matter should be followed closely by you for 90 days. Specific assignments should be given the informant during this period. If, at the end of 90 days, no positive improvement is shown, the file should be closed. The Bureau should be advised of the action taken as to those informants rated "Fair," i.e., were they closed out or did they become productive.

Remarks:

170-286-85

SEARCHED	INDEXED
SERIALIZED	FILED
OCT 27 1971	
FBI - SAN DIEGO	

Chandler

CITY San Diego, California

DATE September 30, 1971

Request of Special Agent in Charge, FBI, San Diego

Two Hundred and Thirty dollars, and Fiftyfive cents.

(\$ 230.55), which money is to be paid by me on September 30, 1971

to INFORMANT

for information concerning the case entitled: Minuteman Organization; WILLIAM CLAY; JERRY LYNN DAVIS; HOWARD CLARK; GERALD L. SMITH; ROGER DRAPEAU; American Nazi Party.

Services: \$ 205.00

Federal Income Tax Withheld \$ _____

Expenses \$ 25.55

Signed: Steven L. Christensen
Special Agent

Have payments been made by other Offices? No Yes (List Offices below.)

Authority (date) Bulet 6/10/71

Period Covered by Payment 9/1 - 30/71

Authorization Checked CLH

Check Number 17582

Receipts Received 10/4/71

Voucher Prepared 10/6/71 Item 17

Date of Actual Payment 9/30/71

By whom SA STEVEN L. CHRISTENSEN

Informant's File No. 170-286

Approved [Signature]
SAC

170-286-84
SEARCHED _____
SERIALIZED _____
FBI - SAN DIEGO

9/21/71

CITY San Diego, California

DATE September 23, 1971

Request of Special Agent in Charge, FBI, San Diego

Two Hundred and Thirtyfive dollars, and Twelve cents,

(\$ 235.12), which money is to be paid by me on September 23, 1971

to informant

for information concerning the case entitled, JERRY LYNN DAVIS; Minuteman Organi-
zation; American Nazi Party; George Hoover; James Evan Poto.

Expenses incurred in use of personal automobile, telephone calls,
and purchase of miscellaneous supplies and other items.

Services: \$ 205.00

Federal Income Tax Withheld \$ _____

Expenses \$ 30.12

Signed: Steven L. Christensen

Special Agent

Have payments been made by other Offices? No Yes (List Offices below.)

Authority (date) Bulet 6/10/71

Period Covered by Payment 8/1 - 31/71

Authorization Checked cab

Check Number 17550

Receipts Received 10/4/71

Voucher Prepared 10/6/71 Item 8

Date of Actual Payment 9/23/71

By whom SA STEVEN L. CHRISTENSEN

Informant's File No. 170-286

170-286-83
SEARCHED _____ INDEXED _____
SERIALIZED _____ FILED _____
FBI - SAN DIEGO

Approved [Signature]
SAC

UNITED STATES GOVERNMENT

Memorandum

TO SA S. CHRISTENSEN (170-238)

DATE: 10/5/71

FROM SUPERVISOR ANTHONY J. MALONEY, JR.

SUBJECT: *informant*

A review of captioned informant's file reflects that the items called for in the FD-377 (Extremist Informant Review Sheet) have not been completed.

You are requested to complete the FD-377 as soon as possible.

1 - San Diego

AJM:mt
(1)

170-256-82
SEARCHED _____ INDEXED _____
SERIALIZED _____ FILED _____
OCT 11 1971
FBI - SAN DIEGO
[Handwritten signature]

UNITED STATES GOVERNMENT

Memorandum

TO : SAC San Diego (170-286)

DATE: 9/30/71

FROM : SA Steven L. Christensen

- TE
- CI
- SI
- R
- PC
- PCI
- PSI
- R (Prob)
-

SUBJECT: *informant*

Dates of Contact
Several times weekly during 8/1 - 9/30/71

File #s on which contacted (Use Titles if File #s not available or when CI provides positive information)

<i>157-1798</i>	
<i>157-1817</i>	
<i>157-2558</i>	
<i>100-14297</i>	
<i>174-428</i>	

Purpose and results of contact

- NEGATIVE
- POSITIVE
- STATISTIC

Info disseminated to files by memo.

Has informant shown any indication of emotional instability, unreliability or furnishing false information? *No*

Informant certified that he has furnished all information obtained by him since last contact.

Coverage
Racial, New Left

PERSONAL DATA

170-286-81

SEARCHED
SERIALIZED
OCT 1 1971
FBI - SAN DIEGO

UNITED STATES GOVERNMENT

Memorandum

TO : ALL AGENTS

DATE: 9/24/71

FROM: SAC ROBERT W. EVANS (170-411)

SUBJECT: EXTREMIST INFORMANTS
EXTREMIST MATTERS

A recent article appearing in the Black Panther Party (BPP) Cleaver Faction publication "Right On!" calls for swift and unmerciful retaliation against current and former extremist informants. This article contains numerous inflammatory statements and may well signal the initiation of widespread retaliation against our informants.

Recently seized items from the Republic of New Africa (RNA) included instructions to RNA members concerning the indoctrination of those members suspected of being law enforcement informants. These instructions basically involve the completion of a personal questionnaire form and background investigation.

Each agent should recognize the continuing possibility of infiltrators within our extremist informant ranks. There have been attempts in the past to penetrate informant ranks, and we can logically expect there will be attempts in the future in this regard. Therefore, all agents are reminded of the importance of in-depth background investigation and personal knowledge of each informant, as well as the necessity for careful verification and evaluation of information furnished by extremist informants.

Each agent handling an extremist informant, including extremist ghetto informants, should be thoroughly alert to the absolute necessity for handling these informants under the most secure conditions in order to eliminate the possibility of these informants being exposed. All agents should also bring to the attention of their informants the Republic of New Africa's methods of disclosing infiltrators in order that our informants will be forewarned.

- 1 - 170-411
- 1 - 170-00
- ② - Each 170 File
- 1 - 66-61

AJM:mt
(262)

170-286-80
SEARCHED INDEXED
SERIALIZED FILED



Buy U.S. Savings Bonds Regularly on the Payroll Savings Plan

SD 170-411

You should indicate in longhand on this memo which will be made part of your informant's file, the date upon which you advised your informant to be alert for the possibility of efforts by leaders of extremist organizations to ferret out infiltrators.

Advised on 9/29/71

TO: SAC, SAN DIEGO (170-286)

9/23/71

FR. M: SA STEVEN L. CHRISTENSEN

SUBJECT: *informant*

Rebulet dated 8/20/71 captioned, "Confidential Fund And Informant Report".

Pursuant to instructions set forth in rebulet a tabulation of payments made to above captioned from Feb. 1, 1971 to July 31, 1971 was made as follows:

SERVICES

Total Amount paid from Feb.1 through July 31, 1971.	-----\$	<u>1100.00</u>
Average monthly payment made.	-----\$	<u>233.33</u>
5% of \$ <u>233.33</u>		<u>11.66</u>

Maximum payment that may be made to this Source per month hereafter.-----\$ 221.67

EXPENSES

Total Amount paid from Feb. 1 through July 31, 1971.	-----\$	<u>303.50</u>
Average monthly payment.	-----\$	<u>50.50</u>
5% of \$ <u>50.50</u>		<u>2.53</u>

Maximum monthly payments allowed for expenses hereafter--\$ 47.97

ASD/

① SD 170-286
1 - SD 66-476
SLC/slc
(2)

Wicks

170-286-
 SEARCHED _____ INDEXED _____
 SERIALIZED _____ FILED _____
 SEP 23 1971
 FBI - SAN DIEGO

RPR/ccc

UNITED STATES ATTORNEY

SOUTHERN DISTRICT OF CALIFORNIA
UNITED STATES COURTHOUSE
325 WEST F STREET
SAN DIEGO 92101

July 28, 1971

Mr. Robert W. Evans
Special Agent in Charge
Federal Bureau of Investigation
3211 Fifth Avenue
San Diego, California 92103

Dear Mr. Evans:

Thank you for your letter of July 26, 1971.

I advised all parties to our conference on July 23, 1971, that the Attorney General has been given statutory authority by Congress to provide witness protection facilities if necessary. The Attorney General's statutory authority in this matter is the Organized Crime Control Act of 1970. However, before any implementation of this act takes place, the United States Attorney's Office must consult with the Criminal Division of the Department of Justice.

Should it become necessary that your informant testifies in the ATFD case, the matter of this informant's safety will be brought to the attention of the Department of Justice.

If you have any further questions, please do not hesitate to contact me.

Very truly yours,

HARRY D. STEWARD
United States Attorney

Robert P. Riso
ROBERT P. RISSO
Assistant U. S. Attorney

170-286-748

SEARCHED	INDEXED
SERIALIZED	FILED
JUL 29 1971	
FBI - SAN DIEGO	

Chertman *1116*

*File
ref in 174-42A*

CITY San Diego, California

DATE July 30, 1971

Request of Special Agent in Charge, FBI, San Diego

Three hundred and fortysix dollars, and no----- cents,

(\$ 346.00), which money is to be paid by me on July 30, 1971

to informant

for information concerning the case entitled Minuteman Organization; JERRY LYNN DAVIS, aka Sam Davis; EUGENE BROWN, Bombing Matter; JAMES EVAN POTO; PETER ROPLINGER; American Nazi Party; National Socialist White Peoples Party. Expenses were incurred in the use of personal automobile, telephone calls and miscellaneous purchases.

Services: \$ 250.00

Federal Income Tax Withheld \$ _____

Expenses \$ 96.00

Signed Steven L. Christensen
Special Agent

Authority (date) Revised 6/10/71

Period Covered by Payment 7/1 - 31/71

Authorization Checked [Signature]

Check Number 17394

Receipts Received 8/2/71

Voucher Prepared 8/4/71 Item 8

Date of Actual Payment 7/30/71

By whom SA STEVEN L. CHRISTENSEN

Informant's File No. 170-286

Approved [Signature] SAC

170-286-77
SEARCHED _____ INDEXED _____
SERIALIZED [initials] FILED [initials]
JUL 31 1971
FBI - SAN DIEGO

CITY San Diego, California

DATE July 23, 1971

Request of Special Agent in Charge, FBI, San Diego

Two Hundred and Ninetyone dollars, and Twentyfive cents,

(\$ 291.25, which money is to be paid by me on July 23, 1971

to informant

for information concerning the case entitled Minuteman Organization; TROY

HAUGHTON; JERRY LYNN DAVIS; MARY TOLLERTON; ROBERT DE PUGH;

PETER RUPLINGER. Expenses incurred in use of telephone, personal automobile and miscellaneous purchases.

Services: \$ 240.00 Federal Income Tax Withheld \$ _____

Expenses \$ 51.25

Signed: Steven L. Christensen
Special Agent

Authority (date) Bulet 6/10/71

Period Covered by Payment 6/1 - 30/71

Authorization Checked cek.

Check Number 77366

Receipts Received 7/27/71

Voucher Prepared 7/30/71 Item 8

Date of Actual Payment 7/23/71

By whom SA STEVEN L. CHRISTENSEN

Informant's File No. 170-286

AK Approved _____ SAC

170-286-
SEARCHED _____
SERIALIZED B J

UNITED STATES GOVERNMENT

Memorandum

TO : SAC San Diego (170-286) DATE: 7/31/71

FROM : SA Steven L. Christensen TE CI SI R
 PC PCI PSI R (Prob)

SUBJECT: informant -

Dates of Contact	
Several Contacts Weekly during period 6/1 - 7/31/71	
File #s on which contacted (Use Titles if File #s not available or when CI provides positive information)	
157-1748	Menutehen
100-14297	Jerry Meyer Davis
157-2609	Nazis Weapons.
157-28	Nazi Party

Purpose and results of contact

NEGATIVE
 POSITIVE
 STATISTIC

"C" memos prepared

Has informant shown any indication of emotional instability, unreliability or furnishing false information? No 170-286-71

Informant certified that he has furnished all information obtained by him since last contact. Coverage: Racial; New Left

PERSONAL DATA

SEARCHED INDEXED
 SERIALIZED FILED
 JUL 31 1971
 FBI - SAN DIEGO

(Handwritten initials)

SAC, SAN DIEGO (174-428) (170-286)

7/30/71

SUPERVISOR ANTHONY J. MALONEY, JR.

JERRY LYNN DAVIS, aka.
ET AL
BOMBING MATTER
(OO: San Diego)

informant
RM - MINUTEMEN

Re memo of Supervisor ANTHONY J. MALONEY, JR., dated 7/28/71 and memo of SA STEVEN L. CHRISTENSEN dated 7/29/71, captioned *informant* RM - MINUTEMEN; San Diego nitel to the Bureau dated 7/23/71, captioned "JERRY LYNN DAVIS, aka., ET AL, BOMBING MATTER."

On 7/30/71, I telephonically furnished the information contained in referenced memos to Mr. J. G. KELLY of the Civil Rights Section at the Bureau.

Mr. KELLY advised that the information contained in the memos should be incorporated in an LHM and furnished to the Bureau under the informant's caption.

Mr. KELLY further suggested that the results of the 7/23/71 conference between ATFD and the U.S. Attorney's Office, San Diego, be furnished to the Bureau in an LHM for transmittal to the Department. Mr. KELLY noted that the Department and the ATFD in Washington, D. C., feel that the delivery of the illuminating grenade by *informant* to DAVIS would constitute a violation under ATFD jurisdiction. It was pointed out to Mr. KELLY that as set forth in referenced nitel, AUSA RISSO at San Diego disagreed with that view and did not consider such a set of facts a prosecutable violation.

The LHM should include information from ATFD or the informant to the effect that the illuminating grenade has or has not been delivered by the informant to subject DAVIS.

2 - 174-428
2 - 170-286

AJM:mt.
(4)

170-286-70

SEARCHED	INDEXED
SERIALIZED	FILED
JUL 30 1971	
FBI - SAN DIEGO	

Christensen

UNITED STATES GOVERNMENT

Memorandum

TO : SAC, SAN DIEGO (170-286)

DATE: 7/29/71

FROM : SA STEVEN L. CHRISTENSEN

SUBJECT: *informant*
RM - MM

Informant was recontacted this date. He advised he has continued to give the matter of relocation considerable thought. He pointed that his parents have, for some time, been trying to convince him of the desirability of moving to Hawaii. He explained that his parents have resided and visited in that state several times and are contemplating moving there permanently in the near future for health and business reasons.

He stated that he still feels that notwithstanding the foregoing, relocation at Boise, Idaho, would be more advantageous for him. He advised he would appreciate assistance from the Bureau in finding employment there.

Source further advised that on 7/27/71 the points required for selling a house with an FHA loan on it rose from 2 to 8. He said that his original estimate of the amount required for his move would, accordingly, be a little low.

1 - SD 170-286
SLC/slc
(1)

170-286-69

SEARCHED	INDEXED
SERIALIZED	FILED
JUL 30 1971	
FBI - SAN DIEGO	

La



Buy U.S. Savings Bonds Regularly on the Payroll Savings Plan

Memorandum

TO : SAC, SAN DIEGO (170-286)

DATE: 7/28/71

FROM : SUPERVISOR ANTHONY J. MALONEY, JR.

SUBJECT: ~~INFORMANT~~
RM - MINUTEMEN

Re San Diego airtel to the Bureau dated 7/28/71.

~~informant~~
On 7/28/71, Mr. and Mrs. CHARLES GODFREY, the parents of ~~informant~~, telephonically advised that they had discussed with their son their son's possible relocation to Boise, Idaho.

The parents stated that they were not satisfied with the possibility of their son's relocation to Boise and felt that in addition to the relocation, the FBI should secure a job for ~~informant~~ in Boise comparable to the \$12,000 a year job he presently holds at San Diego.

Mr. and Mrs. CHARLES GODFREY ~~informant~~ intend to move to Hawaii for health reasons in the near future and suggested the possibility of relocating ~~informant~~ to that state inasmuch as they feel there is an abundance of U. S. Government jobs in Honolulu, one of which the FBI could get for their son without too much difficulty.

During this conversation, Mr. GODFREY mentioned that he has many "friends" in Washington whom he would be glad to contact if it was felt it would help the FBI to help his son. The inference of this remark was interpreted as being that if the FBI did not help ~~informant~~ Mr. GODFREY might seek the assistance of his "friends" in Washington.

It was pointed out to the parents that as of 7/26/71, their son indicated that all he desired was relocation to Boise, but that their feelings in this matter would be made a matter of record.

No assurance of any sort was made to the parents of ~~informant~~.

② - San Diego

AJM:mt

(2)



5010-104

170-286-68

SEARCHED	INDEXED
SERIALIZED	FILED
JUL 28 1971	
FBI - SAN DIEGO	
Christensen	1162

Buy U.S. Savings Bonds Regularly on the Payroll Savings Plan

CITY San Diego, California

DATE July 16, 1971

Request of Special Agent in Charge, FBI, San Diego

Two Hundred and Eighty-two dollars, and no cents,

(\$ 282.00), which money is to be paid by me on July 22, 1971

to informant

for information concerning the case entitled Minuteman Organization; JERRY LYNN DAVIS; FRANK YACOPEC; JAMES EVAN POTO; National Socialist White Peoples Party. Expenses incurred in use of personal automobile, and other miscellaneous purchases.

Services: \$ 215.00

Federal Income Tax Withheld \$ _____

Expenses \$ 37.00

Signed: Steven L. Christensen
Special Agent

Authority (date) Bulet 12/8/70

Period Covered by Payment 5/1 - 31/71

Authorization Checked mal

Check Number 17350

Receipts Received 7/22/71

Voucher Prepared 7/26/71 Item 16

Date of Actual Payment XXXXXXX 7/22/71

By whom SA STEVEN L. CHRISTENSEN

Informant's File No. 170-286

Approved [Signature]
SAC

170-286-65
SEARCHED _____ INDEXED _____
SERIALIZED FB B
FBI-SAN DIEGO 4

CITY San Diego, California

DATE July 11, 1971

Request of Special Agent in Charge, FBI, San Diego

Two Hundred and Seventy-four dollars, and fourty-four cents,

(\$ 274.44), which money is to be paid by me on July 11, 1971

to informant

for information concerning the case entitled Minuteman Organization; JERRY

LYNN DAVIS; San Diego Peace Action Coalition Demonstration, San Diego, California, 4/24/71.

Expenses incurred in use of personal automobile, telephone calls, postage, and purchase of miscellaneous items.

Services: \$ 235.00 Federal Income Tax Withheld \$ _____

Expenses \$ 39.44

Signed: Steven L. Christensen
Special Agent

Authority (date) Bulet 12/8/70

Period Covered by Payment 4/1 to 30/71

Authorization Checked ckh

Check Number 17328

Receipts Received 7/14/71

Voucher Prepared 7/19/71 Item 19

Date of Actual Payment 7/11/71

By whom SA STEVEN L. CHRISTENSEN

Informant's File No. 170p286

170-286-64
SEARCHED
SERIALIZED
INDEXED
FILED

Am Approved _____ SAC

CITY San Diego, California

DATE June 18, 1971

Assistant
Request of Special Agent in Charge, FBI, San Diego

Two Hundred and Thirty-two dollars, and Thirty cents,

(\$ 232.30), which money is to be paid by me on June 18, 1971

to INFORMANT

for information concerning the case entitled Minuteman Organization; JERRY LYNN DAVIS; ISAAC WILLIAM CANTRELL; Student Mobilization Committee.

Expenses were incurred in use of personal automobile, telephone calls, and miscellaneous purchases.

Services: \$ 205.00 Federal Income Tax Withheld \$ _____

Expenses \$ 32.30

Signed: Steven L. Christensen
Special Agent

Authority (date) Bulet 12/8/70

Period Covered by Payment 3/1 - 31/71

Authorization Checked [Signature]

Check Number 17266

Receipts Received 6/18/71 (6/22/71)

Voucher Prepared 6/23/71 Item 17

Date of Actual Payment 6/18/71

By whom SA STEVEN L. CHRISTENSEN

Informant's File No. 170-286

Approved [Signature]
SAC

170-286-63
SEARCHED _____ INDEXED _____
SERIALIZED [Signature]
JUN 23 1971
FBI - SAN DIEGO

UNITED STATES GOVERNMENT

Memorandum

TO : SAC, San Diego (170-286)

FROM : SA Steven L. Christensen

SUBJECT: informant
RM - MRA

DATE: 6/16/71

Attached are results of credit + arrest investigation conducted by SA John R. Baker on 6/14/71.

170-286-62

SEARCHED	INDEXED
SERIALIZED	FILED
JUN 20 1971	
FBI - SAN DIEGO	



5010-106

Buy U.S. Savings Bonds Regularly on the Payroll Savings Plan

Birth Credit Criminal Motor Vehicle Death Marriage* INS

To _____ Buded _____

Return to J. C. Baker File number 100-14819

Name and aliases of subject, applicant, or employee, and spouse
S. Christensen

Addresses

Residence Howard Barry Godfrey
738 Graves, El Cajon, Cal.

Business Fireman, S.O. Fire Dept.

Former _____

*Date and place of marriage (if applicable) _____

Race <u>W</u>	Sex <input checked="" type="checkbox"/> Male <input type="checkbox"/> Female	Age <u>27</u>	Height <u>5'10"</u>	Weight <u>150</u>	Hair <u>Brn</u>	Eyes <u>Brn or Hazel</u>
Birth date <u>7/1/43</u>	Birthplace <u>England</u>		Fingerprint classification		Criminal specialty	

Specific information desired _____

Results of check _____

file since 8-66 last ing 12-69 last WTD 10-69 wife Condy

Address same Pres 4582 Maple LM

Employ City of SD fireman since 10-69

Traveling 10-69 Bacata KC 2366 follow notes BK 169 H 200

RGT Debt 10-58 amount \$ 3.00 pd 1-68

" " 7-58 " " \$ 77.00 pd 5-67

Green Green Cell No debt owing \$ 5.11.25

5-11-76

Birth Credit Criminal Motor Vehicle Death Marriage* INS

To: [Signature] Buded: _____

Return to: Silvatski File number: 100-14819

Name and aliases of subject, applicant, or employee, and spouse: Howard Barry Godfrey 442-5213

Addresses:
Residence: 738 Grand, El Cajon, Cal.
Business: Fireman, S.D. Fire Dept.
4582 Maple Ave., La Mesa. (6/68)

*Date and place of marriage (if applicable): _____

Race <u>W</u>	Sex <input checked="" type="checkbox"/> Male <input type="checkbox"/> Female	Age <u>27</u>	Height <u>5'10"</u>	Weight <u>150</u>	Hair <u>Brn.</u>	Eyes <u>Blue or Hazel</u>
Birth date <u>7/1/43</u>	Birthplace <u>England (Portsmouth, Eng.)</u>					
Arrest Number	Fingerprint classification			Criminal specialty		

Specific information desired: _____

Results of check: S.O. - 6-11-71 - N/R.

FPC:
P.A. - CIA - I/31 W 111 16
I/28 W 111 17
(City Civil Service appli.)
for fireman. 6/26/68
6/11/71 [Signature]

UNITED STATES GOVERNMENT

Memorandum

TO : SAC San Diego (170-286)

DATE: 5/31/71

FROM : SA Steven L. Christensen

- TE
- CI
- SI
- R
- PC
- PCI
- PSI
- R (Prob)
-

SUBJECT: informant

Date of Contact
Several contacts weekly during period 4/1 - 5/29/71

File #s on which contacted (Use Titles if File #s not available or when CI provides positive information)

157-1798

100-15731

157-2224

Purpose and results of contact

NEGATIVE
 POSITIVE
 STATISTIC

"C" memos prepared

FORM 0-1

FILE # *170-286*

DATE RECEIVED *6/3/71*

DATE RETURNED *6/3/71*

REPORT BY *6/4/71*

Has informant shown any indication of emotional instability, unreliability or furnishing false information? *No* *170-286-59*

Informant certified that he has furnished all information obtained by him since last contact.

Coverage
Racials New Left

PERSONAL DATA

SEARCHED	INDEXED
SERIALIZED	FILED

an

CITY San Diego, California

DATE April 22, 1971

Request of Special Agent in Charge, FBI, San Diego

Two Hundred and seventy-seven ^{dollars}, and fifty-one cents,

(\$ 277.51), which money is to be paid by me on April 22, 1971

to informant

for information concerning the case entitled Minuteman Organization; JERRY LYNN DAVIS; Message Information Center; ISAAC WILLIAM CANTRELL; PETER RUPLINGER; LEON NOWER. Expenses were incurred in use of telephone, personal automobile, and purchase of miscellaneous supplies and other articles.

Services: \$ 230.00 Federal Income Tax Withheld \$ _____

Expenses \$ 47.51

Signed: Steven L. Christensen
Special Agent

Authority (date) Bulet 12/8/70

Period Covered by Payment 2/1 - 28/71

Authorization Checked [Signature]

Check Number 17058

Receipts Received 4/22/71 (4/23/71)

Voucher Prepared 4/26/71 Item 19

Date of Actual Payment 4/22/71

By whom SA STEVEN L. CHRISTENSEN

Informant's File No. 170-286

[Signature] Approved _____
SAC

170-286-58
SEARCHED _____ INDEXED _____
SERIALIZED _____ FILED _____
APR 23 1971
FBI - SAN DIEGO

UNITED STATES GOVERNMENT

Memorandum

TO : SAC, San Diego (170-286)

DATE: 3/31/71

FROM : SA Steven L. Christensen

- TE
- CI
- SI
- R
- PC
- PCI
- PSI
- R (Prob)
-

SUBJECT: INFORMANT.

Dates of Contact
Several contacts weekly made during period 2/1 - 3/31/71

File #s on which contacted (Use Titles if File # not available or when CI provides positive information)

157-1798

157-1614

157-2224

100-14273

Purpose and results of contact

- NEGATIVE
- POSITIVE
- STATISTIC

"C" memos prepared

Has informant shown any indication of emotional instability, unreliability or furnishing false information?
No

Informant certified that he has furnished all information obtained by him since last contact.

Coverage
Racial - New Left

PERSONAL DATA

(Handwritten initials)

170-286-57

SEARCHED _____ INDEXED _____
 SERIALIZED _____ FILED _____
 APR - 1 1971
 FBI - SAN DIEGO

UNITED STATES GOVERNMENT

Memorandum

SAC, SAN DIEGO (170-286)

DATE: 3/29/71

FROM

SA STEVEN L. CHRISTENSEN

SUBJECT

INFORMANT

Attached is the registration for the vehicle which followed informant on 3/21/71 as reported in my memo of 3/22/71.

Index:

DAVID JOSEPH FRANCIS

JAMES FORREST BARBER

EARL ROBERT

1 - SD 170-286
SLC/slc
(1)

170-286-56

SEARCHED	INDEXED
SERIALIZED	FILED
MAR 31 1971	
FBI - SAN DIEGO	

IV
3A MC
IV
3A MDC762
FBH

CLETS
IV
3A MDC762
FBH

CLETS

Christensen

032271 0907
FBH 0529
IV FBH
C

DATE: 03/22/71 TIME: 10:06
REG :70 LIC#:MDC762 YRMD:58 MAKE:LINC BTM.:2DHTCA VIN#:H8YAT09917
R/O :FRANCIS DAVID JOSEPH/, BARBER JAMES FORREST/, ROBERT EARL,
407 CHERRY ST CITY:IMPERIAL BCH C.C.:37 ZIP#:92032
SOLE:00/00/55 ISSD:11/05/70 LDC0:5
TYPE:11 CYL :08 SMOG:0 VEH :12 BODY:0 CLAS:80 FEB.:0035 *

END

UNITED STATES GOVERNMENT

Memorandum

TO : SAC, SAN DIEGO (170-286)

DATE: 3/22/71

FROM : SA STEVEN L. CHRISTENSEN

SUBJECT: ~~INFORMANT~~
SI

On 3/21/71 informant advised that while driving to his place of employment at approximately 7:30 AM that morning, he observed, while on IH 8, passing through La Mesa west-bound, that he was being followed by an older model Lincoln automobile. He said this vehicle was very distinctive in that the top and the front doors were painted dark blue with large white stars while the rest of the car was painted in red and white stripes. He said the vehicle followed him to IH 5, then to the Ardath Road exit along which informant attempted several evasive maneuvers without being able to lose the other car.

Informant said he finally stopped alongside the road whereupon the Lincoln stopped in the same block ahead of him. He said both he and the other driver got out and he observed the other was armed ~~with~~ with a metal club. Informant said he put his hand in the pocket of his jacket as though he had a pistol and told the other person to get back in his car or he would shoot. ~~XXXXXX~~ The individual complied, mumbling something about being unpatriotic and there being a lot of hostilities today. Informant described this person as a white male, 22 years of age, wearing a ponytail and Fu Manchu mustache. He had a large white husky dog in the car. He said the car was a 1958 model with California license IDC 762.

Informant advised he was subsequently contacted at work by Detective ROHDE of the PD who advised the other driver had filed a complaint against informant for threat with a deadly weapon. He also complained informant had made an obscene gesture to him in La Mesa which he returned and then followed him 30 miles to find out why he did it. ROHDE said the complainant's name is WILLIAM MARK STANLEY, and he indicated he had borrowed the car from a friend.

1 - SD 170-286
SLC/slc
(1)

170-286-55

SEARCHED	INDEXED
SERIALIZED	FILED
MAR 24 1971	
FBI - SAN DIEGO	

ROHDE said STANLEY would have to return to the PD to indicate whether he wished to press charges against informant, and, in view of circumstances as reported by informant, doubted anything more would come of the matter.

CITY San Diego, California

DATE March 2, 1971

Request of Special Agent in Charge, FBI, San Diego

Two hundred and sixty-nine dollars, and twenty-four cents,

(\$ 269.24), which money is to be paid by me on March 3, 1971

to INFORMANT

for information concerning the case entitled Minuteman Organization; WILLIAM CLAY; JERRY LYNN DAVIS; Message Information Center; GEORGE HOOVER; Virtue In America; PAUL RUPLINGER; LOU CONDE. Expenses were incurred in the use of personal automobile, telephone calls, and purchase of miscellaneous supplies and other articles.

Services: \$ 235.00

Federal Income Tax Withheld \$ _____

Expenses \$ 34.24

Signed: Steven L. Christensen
Special Agent

Authority (date) Bulet 12/8/70

Period Covered by Payment 1/1 - 31/71

Authorization Checked [Signature]

Check Number 16937

Receipts Received 3/3/71 (3/8/71)

Voucher Prepared 3/9/71 Item 12

Date of Actual Payment 3/2/71

By whom SA STEVEN L. CHRISTENSEN

Informant's File No. 170-286

Approved [Signature]
SAC

170-286-54
SEARCHED _____ INDEXED _____
SERIALIZED _____ FILED _____
MAR 1 1971
FBI - SAN DIEGO

CITY San Diego, California

DATE February 18, 1971

Request of Special Agent in Charge, FBI, San Diego

Two hundred and forty-eight dollars, and ninety-seven cents,

(\$ 248.97), which money is to be paid by me on February 18, 1971

to Informant

for information concerning the case entitled Minuteman Organization; WILLIAM CLAY; MARGERIE MC NICKLES; MESSAGE INFORMATION CENTER; STUDENT MOBILIZATION COMMITTEE; TROY HOUGHTON. Expenses were incurred in the use of personal automobile, purchase of literature and supplies, and other miscellaneous articles.

Services: \$ 225.00 Federal Income Tax Withheld \$ _____

Expenses \$ 23.97

Signed: Steven L. Christensen
Special Agent

Authority (date) Bulet 12/8/70

Period Covered by Payment 12/1 - 31/1970

Authorization Checked mad

Check Number 16890

Receipts Received 2/18/71 (2/18/71)

Voucher Prepared 2/24/71 Item 19

Date of Actual Payment 2/18/71

By whom SA STEVEN L. CHRISTENSEN

Informant's File No. 170-286

Approved [Signature]
SAC

170-286-53
SEARCHED
INDEXED
SERIALIZED
FILED

CITY San Diego, California

DATE January 29, 1971

Request of Special Agent in Charge, FBI, San Diego

Two hundred and sixty-one dollars, and forty-nine cents,

(\$ 261.49), which money is to be paid by me on January 29, 1971

to INFORMANT

for information concerning the case entitled MINUTEMAN ORGANIZATION; GEORGE

HOOVER; JERRY LYNN DAVIS; MESSAGE INFORMATION CENTER; STP DAY;

~~MARGERIE MC MICKLES; ROBERT BOLIVAR DE PUGH.~~ Expenses were for

use of personal automobile, telephone calls, postage, and purchase
of various supplies for Minuteman activities.

Services: \$ 210.00

Federal Income Tax Withheld \$ _____

Expenses \$ 51.49

Signed: Steven L. Christensen
Special Agent

Authority (date) Bulet 6/18/70

Period Covered by Payment 11/1 - 30/70

Authorization Checked mal

Check Number 16839

Receipts Received 1/29/71 (2/1/71)

Voucher Prepared 2/2/71 Item 317

Date of Actual Payment 1/29/70

By whom SA STEVEN L. CHRISTENSEN

Informant's File No. 170-286

Approved [Signature]
SAC

170-286-52
SEARCHED _____
SERIALIZED B B
FBI - SAN [Signature]

CITY San Diego, California

DATE January 15, 1971

Request of Special Agent in Charge, FBI, San Diego

Two hundred and thirty-six dollars, and sixtyone cents,

(\$ 236.61), which money is to be paid by me on January 15, 1971

to Informant

for information concerning the case entitled Minuteman Organization; WILLIAM CLAY;
PAUL RUPLINGER; Message Information Center; Venceremos Brigade;
Patriotic Action League; Marjorie McNichols; JERRY LYNN DAVIS;
GEORGE WILLIAM HOOVER. Expenses for use of personal automobile,
postage, telephone calls, purchase of miscellaneous articles.

Services: \$ 205.00

Federal Income Tax Withheld \$ _____

Expenses \$ 31.61

Signed

Steven L. Christensen
Special Agent

Authority (date) Bulet 6/18/70

Period Covered by Payment October 1 to 31, 1970

Authorization Checked [Signature]

Check Number 11787

Receipts Received 1/15/71 (1/27/71)

Voucher Prepared 2/2/71 Item 17.5

Date of Actual Payment January 15, 1971

By whom SA STEVEN L. CHRISTENSEN

Informant's File No. 170-286

Approved [Signature]
SAC

170-286-51
SEARCHED _____
SERIALIZED PS 02
FBI - SAN DIEGO

UNITED STATES GOVERNMENT

Memorandum

TO : SAC *San Diego (170-286)* DATE: *1/31/71*

FROM : SA *Steven L. Christensen* CI SI R (Prob)

SUBJECT: INFORMANT PCI PSI R

Dates of Contact

Several contacts weekly during 12/70 & 1/71

Titles and File #s on which contacted

157-1798 Minuteman Organization
100-14273 New Left Movement

Purpose and results of contact

- NEGATIVE
- POSITIVE
- STATISTIC

"C" memos prepared

<input checked="" type="checkbox"/> Informant certified that he has furnished all information obtained by him since last contact.	Rating <i>Excellent</i>	Coverage <i>Racial - Newleft</i>
---	----------------------------	-------------------------------------

170-286-50

SEARCHED _____ INDEXED _____
SERIALIZED _____ FILED _____
FEB - 1 1971
FBI - SAN DIEGO

CITY San Diego, California

DATE November 20, 1970

Request of Special Agent in Charge, FBI, San Diego

Two Hundred and Fifty-six dollars, and thirty-nine cents,

(\$ 256.39), which money is to be paid by me on ~~November 20, 1970~~ 1/7/71

to Informant

for information concerning the case entitled Minutman Organization; Legion of Justice; WILLIAM CLAY; PETER RUPLINGER; JERRY GEIER; Message Information Center; Visit of President RICHARD M. NIXON to Coronado, California, 11/3/70. Expenses incurred were for use of personal automobile, telephone calls, and purchase of other miscellaneous articles.

Services: \$ 230.00

Federal Income Tax Withheld \$ _____

Expenses \$ 26.39

Signed Steven L. Christensen
Special Agent

Authority (date) Bulet 6/18/70

Period Covered by Payment September 1 - 30, 1970

Authorization Checked [Signature]

Check Number 16629

Receipts Received . 1/7/71 (1/11/71)

Voucher Prepared 1/13/71 Item 20

Date of Actual Payment - ~~November 20, 1970~~ 1/7/71

By whom SA STEVEN L. CHRISTENSEN

Informant's File No. 170-286

Approved [Signature]
SAC

170-286-49
SEARCHED
INDEXED
SERIALIZED
FILED
JAN 11 1971
FBI - SAN DIEGO

UNITED STATES GOVERNMENT

Memorandum

TO : SAC, San Diego (170-286)

DATE: 11/30/70

FROM : SA Steven K. Christensen

- CI SI R (Prob)
- PCI PSI R
-

SUBJECT: INFORMANT

Dates of Contact

Contact several times weekly during period 10/1 - 11/30/70

File #s on which contacted (Use Titles when File #s not available or CI positive info.)

170-17273	New Left Movement
157-	Militant Organization

Purpose and results of contact

- NEGATIVE
- POSITIVE
- STATISTIC

"C" memos prepared

Informant certified that he has furnished all information obtained by him since last contact.

Coverage

Racial + New Left

PERSONAL DATA

170-286-47

SEARCHED	INDEXED
SERIALIZED	FILED
NOV 1 1970	
FBI - SAN DIEGO	

UNITED STATES GOVERNMENT

Memorandum

TO : SAC

DATE: 11/4

FROM : Inspector

SUBJECT:

INFORMANT

CI PCI TE PC GHETTO (PROB)

137 -

134 -

170 -

SI PSI RI RI (PROB)

The file pertaining to the above-captioned informant has been reviewed by the Inspection Staff, and the informant has been rated as:

- Excellent
- Very Good
- Good
- Fair
- Poor
- Insufficient Data to Rate

You are referred to the appropriate survey for instructions as to those informants rated "Poor." If rated "Fair," this matter should be followed closely by you for 90 days. Specific assignments should be given the informant during this period. If, at the end of 90 days, no positive improvement is shown, the file should be closed. The Bureau should be advised of the action taken as to those informants rated "Fair," i.e., were they closed out or did they become productive.

Remarks:

170 - 286 - 45

SEARCHED _____	INDEXED _____
SERIALIZED _____	FILED _____
NOV 1 1977	
FBI - SAN DIEGO	

[Handwritten signature/initials over stamp]

CITY San Diego, California

DATE October 16, 1970

Request of Special Agent in Charge, FBI, San Diego

Two Hundred and Forty-four dollars, and forty-four cents,

(\$ 244.44), which money is to be paid by me on October 16, 1970

to INFORMANT

for information concerning the case entitled National Yippie Day at Disneyland;

PETER RUPLINGER; LEON NOWER; American Volunteer Group; WILLIAM

CLAY; FRANK YACOPEC; San Diego Street Journal; JERRY TARTAGLIO.

Expenses were incurred in use of personal automobile, purchase of stamps and other articles and supplies, newspapers and telephone calls.

Services: \$ 215.00 Federal Income Tax Withheld \$ _____

Expenses \$ 29.44

Signed: Steven L. Christensen
Special Agent

Authority (date) Bulet 6/18/70

Period Covered by Payment August 1 to August 31, 1970

Authorization Checked nd

Check Number 16524

Receipts Received 10/16/70 (10/19/70) ^{10/19}

Voucher Prepared 10/21/70 Item 10

Date of Actual Payment 10/16/70

By whom SA STEVEN L. CHRISTENSEN

Informant's File No. 170-286

Approved [Signature]
SAC

SEARCHED _____ INDEXED _____
SERIALIZED _____ FILED _____
OCT 21 1970
FBI - SAN DIEGO

CITY San Diego, California

DATE September 28, 1970

Request of Special Agent in Charge, FBI, San Diego

Two Hundred and Forty-six dollars, and Seventy cents,

(\$ 246.70), which money is to be paid by me on September 28, 1970

to INFORMANT

for information concerning the case entitled Minuteman Organization; Frank Yacopec; William Clay; Message Information Center; Demonstration, July 4, 1970, San Diego, California; Dale Herschler; San Diego Street Journal. Expenses incurred in use of personal automobile, telephone calls, purchases of miscellaneous articles and supplies.

Services: \$ 210.00

Federal Income Tax Withheld \$ _____

Expenses \$ 36.70

Signed: Steven L. Christensen
Special Agent

Authority (date) Bulet 6/18/70

Period Covered by Payment July 1, 1970 to July 31, 1970

Authorization Checked mal

Check Number 16452

Receipts Received 9/28/70 (9/29/70) 9/29

Voucher Prepared 10/5/70 Item 3

Date of Actual Payment September 28, 1970

By whom SA STEVEN L. CHRISTENSEN

Informant's File No. 170-286

Approved [Signature]
SAC

170-286-43
SEARCHED _____
SERIALIZED _____
OCT 5 1970
FBI - SAN DIEGO
[Signature]

UNITED STATES GOVERNMENT

Memorandum

TO : SAC, *Spivey Dept Station* *WIC - Ad?* DATE: *9/30/70*

FROM : SA *Steven L. Christensen*

- CI SI R (Prob)
- PCI PSI R
-

SUBJECT: **INFORMANT**

Dates of Contact
Contact several times week during period 8/1 - 9/30/70

File #s on which contacted (Use Titles when File #s not available or CI positive info.)

<i>100-14273</i>	<i>New Left Movement</i>
<i>100-17466</i>	<i>Minuteman Organization</i>

Purpose and results of contact

NEGATIVE
 POSITIVE
 STATISTIC

Sub in "A" file

Informant certified that he has furnished all information obtained by him since last contact.

PERSONAL DATA

Coverage
Racial

Per

SEARCHED INDEXED
SERIALIZED FILED
OCT 1 1970
FBI - SAN DIEGO

100-286-42

CITY San Diego, California

DATE July 22, 1970

Request of Special Agent in Charge, FBI, San Diego

Thirty-nine ----- dollars, and forty-seven ----- cents,

(\$ 39.47), which money is to be paid by me on July 22, 1970

to INFORMANT

for information concerning the case entitled Minuteman Organization; Frank Yacopec; Orange County True Press; George Hoover; William Clay; Peter Ruplinger; San Diego Street Journal. Expenses incurred in use of personal automobile, telephone calls and purchase of literature, papers and other supplies.

Services: \$ 0.00

Federal Income Tax Withheld \$ _____

Expenses \$ 39.47

Signed: Steven L. Christensen
Special Agent

Authority (date) Bulet 6/18/70

Period Covered by Payment June 1, 1970 - June 30, 1970

Authorization Checked 16300

Check Number MAH

Receipts Received 7/22/70 (8/3/70)

Voucher Prepared 8/6/70 Item 4

Date of Actual Payment July 22, 1970

By whom SA STEVEN L. CHRISTENSEN

Informant's File No. 170-236

Approved [Signature]
SAC

170-236-41
SEARCHED _____ INDEXED _____
SERIALIZED [initials] FILED [initials]
FBI - SAN DIEGO

CITY San Diego, California

DATE July 10, 1970

Request of Special Agent in Charge, FBI, San Diego

Two hundred----- dollars, and no----- cents,

(\$ 200.00), which money is to be paid by me on July 10, 1970

to INFORMANT

for information concerning the case entitled Minuteman Organization, RM - MM;

WILLIAM CLAY, RM - MM; JERRY LYNN DAVIS, SM - MM; JERRY BUSCH,

RM - MM; Stockpiling of Arms and Ammunition, RM & MISC.; San

Diego Street Journal, IS - MISC.

Services: \$ 200.00

Federal Income Tax Withheld \$ _____

Expenses \$ _____

Signed: Steven L. Christensen
Special Agent

Authority (date) Bulet 6/18/70

Period Covered by Payment 6/1 - 30/70

Authorization Checked [Signature]

Check Number 16269

Receipts Received 7/10/70 (7/22/70)

Voucher Prepared 7/23/70 Item 5

Date of Actual Payment 7/10/70

By whom SA STEVEN L. CHRISTENSEN

Informant's File No. 170-236

Approved [Signature]
SAC

170-236-40
SEARCHED _____ INDEXED _____
SERIALIZED [initials] FILED [initials]
JUL 15 1970
FBI - SAN DIEGO

CITY San Diego, California

DATE July 10, 1970

Request of Special Agent in Charge, FBI, San Diego

Two hundred----- dollars, and no----- cents,

(\$ 200.00), which money is to be paid by me on July 10, 1970

to INFORMANT

for information concerning the case entitled Minuteman Organization, RM - MM;
WILLIAM CLAY, RM - MM; JERRY LYNN DAVIS, SM - MM; JERRY BUSCH,
RM - MM; Stockpiling of Arms and Ammunition, RM - MISC.; San
Diego Street Journal, IS - MISC.

Services: \$ 200.00 Federal Income Tax Withheld \$ _____

Expenses \$ _____

Signed: Steven L. Christensen
Special Agent

Authority (date) Bulet 6/18/70

Period Covered by Payment 6/1 - 30/70

Authorization Checked [Signature]

Check Number 16269

Receipts Received 7/10/70 (7/22/70)

Voucher Prepared 7/23/70 Item 5

Date of Actual Payment 7/10/70

By whom SA STEVEN L. CHRISTENSEN

Informant's File No. 170-236

Approved [Signature]
SAC

170-236-40
SEARCHED _____ INDEXED _____
SERIALIZED SP FILED SP
JUL 15 1970
FBI - SAN DIEGO

CITY San Diego, California

DATE June 2, 1970

Request of Special Agent in Charge, FBI, San Diego, California

One Hundred and twelve dollars, and no----- cents,

(\$ 112.00), which money is to be paid by me on June 3, 1970

to INFORMANT

for information concerning the case entitled Minuteman Organization, IS - MM;
WILLIAM CLAY, SM - MM; FRANK YACOPEC, SM - MM; ROTC Sit-In,
San Diego State College, IS - MISC.; Demonstrations, May, 1970,
to Protest the Military, IS - MISC.; Teach-In on Political
Oppression, San Diego State College, 5/18/70, IS - MISC.

Expenses are for mileage on personal automobile and other
miscellaneous purchases made in connection with services rendered.

Services: \$ 100.00 Federal Income Tax Withheld \$ _____

Expenses \$ 12.00

Signed: Steven L. Christensen
Special Agent

Authority (date) SD let 11/17/69; app. 12/2/69

Period Covered by Payment 5/1 - 31/70

Authorization Checked Trab

Check Number 16156

Receipts Received 6/3/70 (7/22/70)

Voucher Prepared 7/23/70 Item 2

Date of Actual Payment 6/3/70

By whom SA STEVEN L. CHRISTENSEN

Informant's File No. 170-286

Approved [Signature]
SAC

170-286-39
SEARCHED _____ INDEXED _____
SERIALIZED FILED
JUL 5 1970
FBI - SAN DIEGO

CITY San Diego, California

DATE June 2, 1970

Request of Special Agent in Charge, FBI, San Diego, California

One Hundred and fourteen dollars, and thirteen cents,

(\$ 114.13), which money is to be paid by me on June 2, 1970

to: informant

for information concerning the case entitled Minuteman Organization, IS - MM;
WILLIAM CLAY, SM - MM; April 15th. Demonstration against the
War in Vietnam, IS - ANA (VIDEM); Movement for a Democratic
Military, IS - ANA; Peoples Commune, IS - ANA.

Expenses are for mileage on personal automobile, telephone calls
and other miscellaneous expenses and purchases.

Services: \$ 100.00 Federal Income Tax Withheld \$ _____

Expenses \$ 14.13

Signed: Steven L. Christensen
Special Agent

Authority (date) SD let 11/17/69; app. 12/2/69.

Period Covered by Payment 4/1/70 - 4/30/70

Authorization Checked [Signature]

Check Number 16157

Receipts Received 6/3/70 (7/23/70)

Voucher Prepared 7/23/70 Item 1

Date of Actual Payment 6/3/70

By whom SA STEVEN L. CHRISTENSEN

Informant's File No. 170-286

Approved [Signature]
SAC

170-286-38
SEARCHED _____ INDEXED _____
SERIALIZED [initials] FILED [initials]
JUL 2 1970
FBI - SAN DIEGO

UNITED STATES GOVERNMENT

Memorandum

TO : SAC, San Diego (170-286) DATE: 7/31/70

FROM : SA Steven L. Christensen CI SI R (Prob)
 PCI PSI R

SUBJECT: Informant

Dates of Contact

Contact Several times weekly during 6/1 - 7/31/70

File #s on which contacted (Use Titles when File #s not available or CI positive info.)

100-14273	New Left Movement
100-12461	Minuteman Organization
100-14293	William Clay
100-14376	Street Journal

Purpose and results of contact

- NEGATIVE
- POSITIVE
- STATISTIC

Info in "A" file

Informant certified that he has furnished all information obtained by him since last contact.

Coverage

Racial & Newleft

PERSONAL DATA

[Handwritten signature]

1-137-159

SEARCHED	INDEXED
SERIALIZED	FILED
AUG - 2 1970	
FBI - SAN DIEGO	

CITY San Diego, California

DATE April 24, 1970

Request of Special Agent in Charge, FBI, San Diego, California

One hundred and twenty-one dollars, and ninety-three cents,

(\$ 121.93), which money is to be paid by me on April 24, 1970

to [redacted] INFORMANT

for information concerning the case entitled Minuteman Organization, IS - IM;
WILLIAM CLAY, SM - MI; FRANK YACOVIC, SM - MI; GERALD TARTAGLIO,
SM - MI; BETTIE HOUGHTON, SM & MI; JERRY GEIER, SM - IM; San Diego
Free Door to Liberation, IS - Misc.; PEOPLES COMMUNE, IS - AMA;
San Diego Street Journal, IS - Misc.

Expenses are for mileage on personal automobile, purchasing and
processing photographic film, and other miscellaneous purchases in
connection with services performed.

Services: \$ 100.00

Federal Income Tax Withheld \$ _____

Expenses \$ 21.93

Signed: Steven L. Christensen
Special Agent

Authority (date) Sublet 11-17-69; App. 12-2-69

Period Covered by Payment 3/1 - 31/70

Authorization Checked nd

Check Number 16031

Receipts Received 4/24/70 (4/30/70)

Voucher Prepared 5-11-70 Item 5

Date of Actual Payment ~~XXXXXX~~ 4/24/70

By whom SA STEVEN L. CHRISTENSEN

Informant's File No. 170-286

Approved [Signature]
SAC

170
F-34-286-23
SEARCHED _____ INDEXED _____
SERIALIZED FILED
APR 24 1970
FBI - SAN DIEGO

CITY San Diego, California

DATE March 30, 1970

Request of Special Agent in Charge, FBI, San Diego

One hundred and twenty-four dollars, and thirty-three cents,

(\$ 124.33), which money is to be paid by me on 3/30/70

to INFORMANT

for information concerning the case entitled Minuteman Organization, IS - MM (100-12461); New Left Movement, IS - ANA (100-14273); People's Commune, IS - ANA (100-14911); Student Demonstration, San Diego State College, 3/12/70 (100-14998); Dale Herschler, SM - R (157-800). Informant

also provided visual and photographic coverage of demonstration in downtown San Diego on 2/27/70. Expenses are for travel and other purchases necessary to services rendered.

Services: \$ 100.00 Federal Income Tax Withheld \$ _____

Expenses \$ 24.33

Signed: Steven L. Christensen
Special Agent

Authority (date) SD Exlet 11-17-69; (1/14/70) 12-2-69

Period Covered by Payment 2/1 - 28/70

Authorization Checked MAH

Check Number 15956

Receipts Received 3/30/70 (4-30-70)

Voucher Prepared 5-11-70 Item 1

Date of Actual Payment 3/30/70

By whom SA STEVEN L. CHRISTENSEN 134-206-32

Informant's File No. 170 - 286

Approved [Signature]
SAC

SEARCHED _____	INDEXED _____
SERIALIZED _____	FILED _____
MAY 11 1970	
FBI - SAN DIEGO	

CITY SAN DIEGO, CALIFORNIA

DATE March 3, 1970

Request of Special Agent in Charge, FBI, San Diego Division

One hundred and sixteen dollars, and twenty-nine cents,

(\$ 116.29), which money is to be paid by me on March 3, 1970

to INFORMANT

for information concerning the case entitled Minuteman Organization, IS - MM;

WILLIAM CLAY, SM - MM; FRANK YACOPEC, SM - MM; Movement for
a Democratic Military, IS - Misc.; New Left Movement, IS - ANA.

Expenses are for travel and other purchases made in connection
with services rendered.

Services: \$ 100.00 Federal Income Tax Withheld \$ -----

Expenses \$ 16.29

Signed: Steven L. Christensen
Special Agent

Authority (date) SO let 11/17/69
Bulet 12/2/69

Period Covered by Payment 1/1 - 31/70

Authorization Checked Paul

Check Number 15874

Receipts Received 3-3-70 (4-11-70)

Voucher Prepared 4/21/70 Item 1

Date of Actual Payment 3/3/70

By whom SA STEVEN L. CHRISTENSEN

Informant's File No. ~~221-011~~ 100-256-

Approved [Signature]
SAC

31

170-286-29

SEARCHED	INDEXED
SERIALIZED	FILED
APR 10 1970	
FBI - SAN DIEGO	

12-10-65

Mark opposite each item the number of the serial or serials in which the information appears. Although these items are regarded as nonvariable, changes may be noted by adding the new serial number and crossing out the old. When form is complete as to all applicable items, the Agent and Field Supervisor should initial the form at the end.

Symbol Number INFORMANT

INFORMANT

Office File 137-919-210-251

Type of Informant: SI PSI CS RI

Bureau File 137-17222

Serial No.

1. Name _____

1

2. Aliases _____

137-1643-24

3. Code Name _____

11

4. Symbol Number _____

2

5. Date and Place of Birth _____

1

6. Description _____

1

7. Photograph _____

8. Background Investigation:

(A) File references checked _____

1

(B) Credit Inquiry _____

1

(C) Local Criminal Check _____

1

(D) Bureau Identification Record _____

137-1643-6

(E) Selective Service Check _____

1

(F) Check of Armed Services Record _____

1

(G) Informants Canvassed _____

1

(H) Reliability Check _____

1

(I) Patriotism _____

1

(J) Reputation _____

1

9. Informant Advised Of:

(A) Not Bureau employee _____

137-1643-24

(B) Activities Voluntary _____

137-1643-24

(C) Relationship Confidential _____

137-1643-24

(D) Bureau Labor Policy _____

137-1643-24

(E) Not to Retain Copies of Notes - Reports _____

137-1643-24

(F) Report to be submitted under Code Number and in Third Person _____

137-1643-24

(G) Payments are Income _____

137-1643-24

(H) Use Public Telephones _____

137-1643-24

(I) No Office Contact Personally _____

137-1643-24

10. Statement of Cooperation _____

1

11. Post Office Box Number Assigned _____

12. Informant Indices Card Made _____

22/10/65

1

13. Agent Who Handles Information _____

1

14. Alternate Agent _____

15

15. Concernment and Characterization Guide _____

16. Flash Notice Placed _____ or Removed _____

137-1643-24

17. Coverage Min 15 mos.

No Serial Number:

Keep on Top of Other Serials in File.

Initials _____ Agent

Supr _____

UNITED STATES GOVERNMENT

Memorandum

TO : SAC, San Diego (134-914) DATE: 1/30/70

FROM : SA Steven L. Christensen

CI SI R (Prob)
 PCI PSI R

SUBJECT: INFORMANT - -

Dates of Contact	
11/15/69; 11/29/69; 12/13/69; 12/29/69; 1/11/70; 1/30/70	
Titles and File #s on which contacted	
MM Organization	100-12461
New Left	100-17273

Purpose and results of contact

NEGATIVE
 POSITIVE
 STATISTIC

"C" Memos prepared

3/18/70
make case
70

Christensen ME

<input checked="" type="checkbox"/> Informant certified that he has furnished all information obtained by him since last contact.	Rating Excellent	Coverage Security Matters
---	---------------------	------------------------------

1-134-914

134-914-24

SEARCHED	INDEXED
SERIALIZED	FILED
FEB - 2 1970	
FBI - SAN DIEGO	

closed
3/18/70

170-286-29

CITY San Diego, California

DATE January 16, 1970

Request of Special Agent in Charge, FBI, San Diego Division

One hundred and twenty-two dollars, and forty-three cents,

(\$ 122.43), which money is to be paid by me on January 16, 1970

to INFORMANT

for information concerning the case entitled Minuteman Organization, IS-MM;
WILLIAM CLAY, SM-AM; ELLS DANNING, SM-MM; TROY HOUGHTON, SM-PM;
BETTIE HOUGHTON, SM-MM; PEOPLE'S COMMUNE, IS-ANA; DALE HERSCHLER,
RM; SAN DIEGO STREET JOURNAL, IS-MISC., (NEW LEFT - UNDERGROUND
NEWSPAPER)

Expenses are for travel and purchases of literature and other
materials in connection with services performed.

Services: \$ 100.00 Federal Income Tax Withheld \$ _____

Expenses \$ 22.43

Signed Steven L. Christensen
Special Agent

Authority (date) Delet SD let 11/17/69 (Appd. 12/2/69)

Period Covered by Payment 12/1 - 31/69

Authorization Checked gml

Check Number 15729

Receipts Received 1/16/70 (1/23/70)

Voucher Prepared 1/30/70 Item 11

Date of Actual Payment 1/16/70

By whom SA STEVEN L. CHRISTENSEN

Informant's File No. 131-914

Approved [Signature]
SAC

170-286-28
34-9-1-1-15
SEARCHED _____ INDEXED _____
SERIALIZED 3 FILED _____
JAN 30 1970
FBI - SAN DIEGO

CITY San Diego, California

DATE December 15, 1969

Assistant -
Request of Special Agent in Charge, FBI, San Diego

One hundred-nineteen dollars, and thirty-six cents,

(\$ 119.36), which money is to be paid by me on December 15, 1969

to INFORMANT

for information concerning the case entitled Minuteman Organization, IS - MM;

WILLIAM CLAY, SM - MM; LYLE MANNING, SM - MM; DEMNOV, IS - Misc.

Informant provided important information relating to activities of above including photographic coverage of the November 15th demonstrations. In addition informant has provided limited information regarding the activities of the San Diego Free Press and the San Diego Free Door.

Services: \$ 100.00

Federal Income Tax Withheld \$ _____

Expenses \$ 19.36

Signed: Steven L. Christensen
Special Agent

Authority (date) Bulet 7-2-69

Period Covered by Payment 11/1 -30/69

Authorization Checked Inl

Check Number 15646

Receipts Received 12/15/69 (12/16/69)

Voucher Prepared 1/5/70 Item 8

Date of Actual Payment 12/15/69

By whom SA STEVEN L. CHRISTENSEN

Informant's File No. 134-914

Approved [Signature]
SAC

170-256-27
134-914-27
SEARCHED _____ INDEXED _____
SERIALIZED 4 FILED _____
JAN 5 1970
FBI - SAN DIEGO

CITY San Diego, California

DATE November 10, 1969

Request of Special Agent in Charge, FBI, San Diego

One hundred and sixteen--dollars, and fifty cents,

(\$ 116.50), which money is to be paid by me on November 10, 1969

to INFORMANT

for information concerning the case entitled October 15th Committee (100-14794)
Minuteman Organization (100-12461); DENNOV (100- 14736); San Diego
FREE DOOR 9157-300); WILLIAM CLAY (100-14293); LYLE FANNING (100-14299)

Informant has provided coverage of members of the Minuteman Organization
and other "right wing" groups in the area. He has reported on activities
of the underground newspaper, The San Diego Free Door to Liberation,
and advised of its change of address. Informant provided visual as
well as photographic coverage of the October 15th Moratorium events
at San Diego State College including activities leading up to the
Moratorium on previous days.

Services: \$ 95.00 Federal Income Tax Withheld \$ _____

Expenses \$ 21.50

Signed: Steven L. Christensen
Special Agent

Authority (date) Bulet 7/2/69

Period Covered by Payment 10/1 - 31/69

Authorization Checked Sub

Check Number 15551

Receipts Received 11/10/69 (11/17/69)

Voucher Prepared 11/24/69 Item 2

Date of Actual Payment 11/10/69

By whom SA STEVEN L. CHRISTENSEN

Informant's File No. 134-914

Approved [Signature]
SAC

170-286-25
134-C-14-25
SEARCHED _____ INDEXED _____
SERIALIZED 11 FILED _____
NOV 25 1969
FBI - SAN DIEGO

UNITED STATES GOVERNMENT

Memorandum

TO : SAC *San Diego*

FROM : SA *Steven L. Christensen*

SUBJECT: *Informant*

DATE: *10/31/69*

CI SI R (Prob)

PCI PSI R

Dates of Contact	
<i>9/8 ; 9/12 ; 9/18 ; 10/8 ; 10/10 ; 10/20 ; 10/30/69</i>	
Titles and File #s on which contacted	
<i>Minuteman Organization</i>	<i>100-124161</i>
<i>Paul Ruffinger</i>	<i>100-14301</i>
<i>Bill Clark</i>	<i>100-14293</i>
<i>Oct. 15 Committee to End the War</i>	<i>100-14794</i>

Purpose and results of contact

- NEGATIVE
- POSITIVE
- STATISTIC

"C" memos prepared

Please show SA Arnold O'Brien as Alternate Agent.

Informant certified that he has furnished all information obtained by him since last contact.

Rating

Excellent

Coverage

Minuteman & Newleft activities
170-256-23

SEARCHED	INDEXED
SERIALIZED	FILED
OCT 31 1969	
FBI - SAN DIEGO	

170-677-23

UNITED STATES GOVERNMENT

Memorandum

TO : SAC

DATE: 10/29/69

FROM : Inspector

SUBJECT: INFORMANT
CI PCI TE PC GHETTO (PROB)
SI PSI RI RI (PROB)

137 -
134 - 914
170 -

The file pertaining to the above-captioned informant has been reviewed by the Inspection Staff, and the informant has been rated as:

- Excellent
- Very Good
- Good
- Fair
- Poor
- Insufficient Data to Rate

You are referred to the appropriate survey for instructions as to those informants rated "Poor." If rated "Fair," this matter should be followed closely by you for 90 days. Specific assignments should be given the informant during this period. If, at the end of 90 days, no positive improvement is shown, the file should be closed. The Bureau should be advised of the action taken as to those informants rated "Fair," i.e., were they closed out or did they become productive.

Remarks:

J.P. Baker

170-256-22

~~134-914-02~~

SEARCHED	INDEXED
SERIALIZED	FILED
OCT 29 1969	
FBI - SAN DIEGO	
2) <i>S. Christensen</i>	

UNITED STATES GOVERNMENT

Memorandum

TO : SAC San Diego (134-914)

DATE: 8/29/69

FROM : SA Steven L. Christensen

- CI SI R (Prob)
- PCI PSI R
-

SUBJECT: INFORMANT

Dates of Contact <i>6/11/69</i>	
<i>6/14/69, 7/17/69, 7/30/69, 8/6/69, 8/17/69, 8/29/69</i>	
Titles and File #s on which contacted	
<i>Minuteman Organization</i>	<i>100-12461</i>

Purpose and results of contact

NEGATIVE
 POSITIVE
 STATISTIC

Info in "C" memos

170-286-20
134-914-20

<input checked="" type="checkbox"/> Informant certified that he has furnished all information obtained by him since last contact.	Rating <i>Excellent</i>	Coverage <i>Security - Minuteman</i>
---	----------------------------	---

SEARCHED	INDEXED
SERIALIZED	FILED
JUL 1969	
FBI - SAN DIEGO	

CITY San Diego, California

DATE August 5, 1969

Request of Special Agent in Charge, FBI, San Diego, California

Eighty-one --- dollars, and Forty-three --- cents,

(\$ 81.43), which money is to be paid by me on August 5, 1969

to INFORMANT

for information concerning the case entitled The Minuteman Organization

Expenses are for travel, telephone calls, purchases, and miscellaneous expenses in connection with coverage of the Minuteman Organization and related groups.

Services: \$ ~~50.00~~ 65.00 Federal Income Tax Withheld \$ _____

Expenses \$ 16.43

Signed: *Steven R. Christensen*
Special Agent

Authority (date) Bulet 7-2-69

Period Covered by Payment 7/1-31/69

Authorization Checked Incl.

Check Number 15264

Receipts Received 8/5/69 (2/12/69)

Voucher Prepared 8/13/69 Item 6

Date of Actual Payment 8/5/69

By whom S. Christensen

Informant's File No. 134-911

Approved *[Signature]*
SAC

770-256-19
134-914-19
SEARCHED _____ INDEXED _____
SERIALIZED _____ FILED _____
FBI - SAN DIEGO

CITY San Diego, California

DATE June 11, 1969

Request of Special Agent in Charge, FBI, San Diego, California

Seventy-nine dollars, and sixty cents,

(\$ 79.60), which money is to be paid by me on June 12, 1969

to INFORMANT

for information concerning the case entitled Minutemen Organization, 100-12461;
DePugh Bank Robbery, 91-3149; Berkeley Memorial Days Committee,
100-14603.

Services: \$ 70.00 Federal Income Tax Withheld \$ _____

Expenses \$ 9.60

Signed: Steven L. Christensen
Special Agent

Authority (date) Bulet 12/6/68

Period Covered by Payment 4/6 - 5/30/69

Authorization Checked jes.

Check Number 15093

Receipts Received 6/12/69 (3/12/69)

Voucher Prepared 8/13/69 Item 1

Date of Actual Payment 6/12/69

By whom SA STEVEN L. CHRISTENSEN

Informant's File No. 134-914

Approved [Signature]
SAC

170-256-15
434-814-18
SEARCHED _____ INDEXED _____
SERIALIZED [initials] 1969
FBI - SAN DIEGO

UNITED STATES GOVERNMENT

Memorandum

TO : SAC San Diego (134-914)

DATE: 5/29/69

FROM : SA Steven L. Christensen

CI SI R (Prob)

PCI PSI R

SUBJECT: INFORMANT

Dates of Contact	
4/18/69; 5/7/69; 5/23/69	
Titles and file # on which contacted	
Minkerman Organization	100-12461
DePugh BR	91-3149
Berkeley Mem. Days Comm.	100-14603

Purpose and results of contact

- NEGATIVE
- POSITIVE
- STATISTIC

"C" memos prepared
 Make SA Arnold W. O'Brien
 Alternate Agent.

170-280-15
 134-914-15
 SEARCHED _____ INDEXED _____
 SERIALIZED _____ FILED _____
 MAY 29 1969
 FBI - SAN DIEGO

Informant certified that he has furnished all information obtained by him since last contact. Rating: *Excellent*

Coverage
 Minkerman's office
 Right wing activities
 Activities of New Left
 + Radical Organizations

FORM 0-1

CITY SAN DIEGO, CALIFORNIA

DATE May 7, 1969

Request of Special Agent in Charge, FBI, SAN DIEGO

Fifty dollars, and no cents,

(\$ 50.00), which money is to be paid by me on May 7, 1969

to INFORMANT

for information concerning the case entitled POLITICAL OPPRESSION TEACH-IN, San Diego State College, May 5, 1969.

Services: \$ 37.50

Federal Income Tax Withheld \$ _____

Expenses \$ 12.50

Signed: Steven L. Christensen
Special Agent

Authority (date) Bulet 12/6/68

Period Covered by Payment 4/1 5/5/69

Authorization Checked Incl

Check Number 14965

Receipts Received 5/7/69 (5/7/69)

Voucher Prepared 5/9/69 Item 16

Date of Actual Payment 5/7/69

By whom SA STEVEN L. CHRISTENSEN

Informant's File No. 134-914

Approved _____
SAC

170-286-14
134-914-141
SEARCHED _____ INDEXED _____
SERIALIZED _____ FILED _____
MAY 9 1969
FBI - SAN DIEGO
12

CITY San Diego, California

DATE April 18, 1969

Request of Special Agent in Charge, FBI, San Diego

Forty dollars, and No cents,

(\$ 40.00), which money is to be paid by me on 4/18/69

to INFORMANT

for information concerning the case entitled MINUTEMAN ORGANIZATION; IS - MM

US - RM; BPP - RM

Services: \$ 29.00

Federal Income Tax Withheld \$ _____

Expenses \$ 11.00

Signed: Steven P. Christensen
Special Agent

Authority (date) Bulet 12/6/68

Period Covered by Payment 3/16-31/69

Authorization Checked Mel

Check Number 14908

Receipts Received 4/18/69 (4/25/69)

Voucher Prepared 4/28/69 Item 5

Date of Actual Payment 4/18/69

By whom SA S. L. CHRISTENSEN

Informant's File No. 134-914

Approved Σ
SAC

170-256-13
134-914-13
SEARCHED _____ INDEXED _____
SERIALIZED J FILED J
APR 23 1969
FBI - SAN DIEGO

CITY San Diego, California

DATE March 28, 1969

Request of Special Agent in Charge, FBI, San Diego, California

Forty-eight dollars, and no cents,

(\$ 48.00), which money is to be paid by me on March 28, 1969

to INFORMANT

for information concerning the case entitled Minuteman Organization; Black

Panther Party; New Left Movement

Services: \$ 36.00

Federal Income Tax Withheld \$ _____

Expenses \$ 12.00

Signed: Steven L. Christensen
Special Agent

Authority (date) July 12/6/68

Period Covered by Payment 3/1 - 3/15/69

Authorization Checked Sub

Check Number 14823

Receipts Received 3/28/69 (4/1/69)

Voucher Prepared 4/14/69 Item 6

Date of Actual Payment 3/28/69

By whom SA STEVEN L. CHRISTENSEN

Informant's File No. 134-914

Approved [Signature]
SAC

170-256-12A
134-914-1

SEARCHED _____ INDEXED _____
SERIALIZED [initials] FILED [initials]
APR 14 1969
FBI - SAN DIEGO

UNITED STATES GOVERNMENT

Memorandum

TO : SAC San Diego (134-914)

DATE: 4-4-69

FROM : SA Steven L. Christensen

CI SI R (Prob)

PCI PSI R

SUBJECT: INFORMANT

Dates of Contact

3/10/69; 3/12/69; 3/14/69; 3/25/69; 4/7/69

Titles and File #s on which contacted

Minuteman Organization	100-124161
BPP	100-13978
New Left	100-14273

Purpose and results of contact

- NEGATIVE
- POSITIVE
- STATISTIC

"C" Memos prepared.

170-256-12

Informant certified that he has furnished all information obtained by him since last contact.

Rating: Excellent

Coverage: Minuteman, New Left & related Security Matters

SEARCHED	INDEXED
SERIALIZED	FILED
APR 11 1969	
FBI - SAN DIEGO	

134-914-12

CITY San Diego, California

DATE March 12, 1969

Request of Special Agent in Charge, FBI, San Diego, California

Fifty dollars, and no cents,

(\$ 50.00), which money is to be paid by me on March 12, 1969

to INFORMANT

for information concerning the case entitled Minutemen Organization; IS - MM.

Black Panther Party; RM - BPP. ROBERT BOLIVAR DE PUGH; BR.

Services: \$ 37.00

Federal Income Tax Withheld \$ 0.00

Expenses \$ 13.00

Signed: Steven L. Christensen
Special Agent

Authority (date) Bulet 12/6/68

Period Covered by Payment 2/11 - 2/13/69

Authorization Checked Lul

Check Number 14758

Receipts Received 3/12/69 (3/13/69)

Voucher Prepared 3/18/69 Item 6

Date of Actual Payment 3/12/69

By whom SA STEVEN L. CHRISTENSEN

Informant's File No. 134-914

Approved [Signature]
SAC

170-266-10
134-914-70
SEARCHED _____ INDEXED _____
SERIALIZED _____ FILED _____
MAR 13 1969
FBI - SAN DIEGO

CITY San Diego, California

DATE February 13, 1969

Request of Special Agent in Charge, FBI, San Diego, California

Fifty dollars and no cents,

(\$ 50.00), which money is to be paid by me on February 13/1969

to INFORMANT

for information concerning the case entitled Minutemen Organization; IS - PM

Services: \$ 35.00 Federal Income Tax Withheld \$ _____

Expenses \$ 15.00

Signed: [Signature]
Special Agent

Authority (date) Bulet 12-6-68

Period Covered by Payment 1/1-14/69

Authorization Checked Sub

Check Number 14670/

Receipts Received 2-13-69 (2-12-69)

Voucher Prepared 2-19-69 Item 11

Date of Actual Payment 2-13-69

By whom SA Christensen

Informant's File No. 134-914

Approved [Signature]
SAC

170-756 9A
134-914-9A
SEARCHED _____ INDEXED _____
SERIALIZED _____ FILED _____
FEB 19 1969
FBI - SAN DIEGO

UNITED STATES GOVERNMENT

Memorandum

TO : SAC, San Diego (134-914)

DATE: 2-14-69

FROM : SA Steven L. Christensen

CI SI R (Prob)

PCI PSI R

SUBJECT: INFORMANT

Dates of Contact	
1/14/69, 1/15/69, 1/24/69, 1/31/69, 2/13/69	
Titles and File #s on which contacted	
Minuteman Organization	100-12461
US Organization	157-328
DeLoach BR	91-3149

Purpose and results of contact

- NEGATIVE
- POSITIVE
- STATISTIC

"C" memos prepared

[Handwritten mark]

170-256-9

Informant certified that he has furnished all information obtained by him since last contact.

Rating

Excellent

Coverage

Minuteman, Black & New Left militant organizations

SEARCHED	INDEXED
SERIALIZED	FILED
FEB 17 1969	
FBI - SAN DIEGO	

134-914-4

UNITED STATES GOVERNMENT

Memorandum

TO : SAC, SAN DIEGO (134-914) (P)

DATE: 1/24/69

FROM : SA C. JORDAN NAYLOR

CI SI R (Prob)

PCI PSI R

SUBJECT: INFORMANT

Dates of Contact 12/2, 3, 5, 9, 10, 12, 16, 17, 18/68	
Titles and File #s on which contacted	
ROBERT DE PUGH - BANK ROBBERY	91-3149
MINUTEMEN - IS-C	100-12461
BILL CLAY	100-14293
MIKE VEJVODA	100-14302

Purpose and results of contact

- NEGATIVE
- POSITIVE
- STATISTIC

The informant furnished the residence address of JOHN BUSH at 12320 Parkside, Lakeside, California.

Informant said BUSH continues to deal in various types of weapons and recently told him he had just seen the largest number of machine guns he had ever seen at one time. BUSH did not indicate where he had seen these machine guns or the conditions under which they had been observed. Informant said he would attempt to determine this information through further contact with BUSH. It is to be noted that BUSH has previously been suspected of dealing in weapons to minority groups and BUSH's wife was observed at a CLEAVER rally in San Diego recently, when she was wearing a "Free Hughey" button. Informant advised he has discussed BUSH's activities with BILL CLAY and CLAY has indicated he intends to turn BUSH into proper police authorities.

Informant said he, BILL CLAY, and WALT HAYWARD, recently published a one-page edition of a bulletin containing eighteen names, addresses and background information on liberals located in the San Diego area. He said it was the

Informant certified that he has furnished all information obtained by him since last contact.

Rating

EXCELLENT

Coverage

SECURITY and MINUTEMEN ACTIVITIES

SEARCHED	INDEXED
SERIALIZED	FILED
FEB - 3 1969	
FBI - SAN DIEGO	

① - 134-914

1 - 100-14016

1 - 100-14302

1 - 134-914 A

CJN:pgh (6)

1 - 91-3149

1 - 100-14293

1 - 100-461

134-914-8
170-256-5

intention of the group to distribute these pamphlets to various groups, particularly including liberal organizations so that it would be well known that these individuals were known to right wing groups. Informant said the bulletin bore the name of the "Phantom Militia", and was to be distributed on a completely anonymous basis. About two days after publication of the bulletin and before distribution had taken place, CLAY contacted HAYWARD and others and indicated the paper should not be distributed, although it was noted that one copy had already been distributed to the front door of the Good Morning Teaspoon. Informant subsequently determined that CLAY's reason for removal of these bulletins was that one of the names indicated on the list was known only to CLAY and publication of this man's name and background would have positively identified CLAY as the source of information relative to this individual's activities.

Informant, on 12/6/68, indicated he had attended a meeting of the Lakeside Conservative Council held at the Weslian Church, Lakeside, on River Street, attended by approximately 26 individuals. The film was shown on gun control laws which film was made available by the Patriotic Society. Informant identified some of those present as WALT HAYWARD, BILL CLAY, STAN MC DADE, JERRY GIYER, ROBIE ROBINSON, and this ROBINSON is employee of the telephone company, and others whose names were unknown to informant. Informant indicated he believes MC DADE is active in the Patriotic Society, and described him as a white male, approximately 45 to 50 years of age, 5' 9", 225 pounds, dark hair, wears a goatee and mustache.

Informant furnished the address of WALTER HAYWARD as 12067 Riverside Drive, Lakeside, California, telephone 448-2954. He indicated that at a meeting on 12/6/68, HAYWARD, CLAY and others present, discussed ways and means of agitating the Peace and Freedom Party and the Black Panther Party to get them to fight among themselves. Informant said that the latest publication of the Patriotic Party had been a survival bulletin which contained direct quotations from Staff Publication.

Informant said that since the gun control law has become so common that numerous individuals have been attempting to obtain and hide as many weapons and as much ammunition as possible. Informant said he had recently determined that JERRY GIYER in addition to possessing many other weapons, has a .50 caliber Colt machine gun, an anti-tank rifle, a line-throwing gun, and an M-14 rifle. Informant advised on 12/9/68, that WALT HAYWARD and BILL CLAY had recently attended a Swap Meet where they sold approximately fifteen dollars of miscellaneous items and intended

to use the cash raise in a publication not of various bulletins. Informant said that he learned that a Black Panther Party meeting had taken place the previous Friday evening and on notifying WALT HAYWARD of this, HAYWARD made several telephone calls, attempting to agitate the Black Panthers and to create friction between the Panthers and the Peace and Freedom Party.

Informant said LYLE MANNING recently advised that an individual by the name of MARCUS from Phoenix, Arizona, has been in San Diego, and is interested in selling weapons. Informant indicated it appears that MARCUS is well known as a weapons distributor and has been known to sell weapons to the Israeli Government. He indicated MARCUS had a recoilless rifle 106 millimeter, which he was asking \$3000 for. Informant said he learned that MARCUS was willing to stash a large number of weapons in a cache in the San Diego area, if right wingers in this area could prove to him that there were a sufficient number of dangerous left wingers to create a need for such a weapons supply. MANNING and FRANK YODUS, the local area representative for Liberty Arms, co-owners of the Hanging Tree Swap Shop, continue in business. Informant said he does not know the extent of their success in this new business as yet. MARCUS was further described as a wholesale meat packer and an owner of at least one department store in the Phoenix, Arizona area.

Informant said MIKE VEJVODA has someone who is assisting him financially in printing numerous handbills which bills are being passed out in left wing neighborhoods in an attempt to agitate and create disturbances. VEJVODA is apparently very interested in making an example of some left winger and has indicated he plans to burn someone's house down or possibly take some individual out into the desert to kill them to make an example out of them. Informant said he advised BILL CLAY of this information and CLAY told VEJVODA that if he should do such a thing, his life would be taken himself. Informant advised that BETTIE HAUGHTON is completely inactive in Minutemen activities at this time and no information has been received regarding the whereabouts of ROBERT DE PUGH or PEYSON.

UNITED STATES GOVERNMENT

Memorandum

TO : SAC SAN DIEGO (134-914)

DATE: 1/30/69

FROM : SA STEVEN L. CHRISTENSEN

- CI
- SI
- R (Prob)
- PCI
- PSI
- R
-

SUBJECT: *INFORMANT*

Dates of Contact		
12/23/68; 1/3/69; 1/7/69; 1/9/69		
Titles and File #s on which contacted		
Minuteman Organization		100-12161
Peace and Freedom Party		100-11061
Robert Bolivar DePugh		91-3119
Purpose and results of contact		
<input type="checkbox"/> NEGATIVE See Channelizing Memo. <input checked="" type="checkbox"/> POSITIVE <input type="checkbox"/> STATISTIC		
<input checked="" type="checkbox"/> Informant certified that he has furnished all information obtained by him since last contact.	Rating Excellent	Coverage Security

[Handwritten signature]

1 - SD 134-914

134-914-21

SEARCHED	INDEXED
SERIALIZED	FILED
JAN 30 1969	
FBI - SAN DIEGO	

CITY San Diego, California

DATE January 14, 1969

Request of Special Agent in Charge, FBI, San Diego

Fifty dollars, and no cents,

(\$ 50.00), which money is to be paid by me on 1/17/69

to INFORMANT

for information concerning the case entitled Minutemen, SM - M; Black Panther Party,

RM - BBP; Peace and Freedom Party, SM - BF

Services: \$ 40.00

Federal Income Tax Withheld \$ _____

Expenses \$ 10.00

Signed: Steven L. Christensen
Special Agent

Authority (date) Bulet 12-4-68

Period Covered by Payment 12/12 - 12/31/68

Authorization Checked ml

Check Number 14557

Receipts Received 1/17/69 (1/17/69)

Voucher Prepared 1/21/69 Item 19

Date of Actual Payment 1/17/69

By whom SA S. CHRISTENSEN

Informant's File No. 134- 914 - 6

Approved [Signature]
SAC

170-286-6
134-914-6
SEARCHED _____ INDEXED _____
SERIALIZED 43 FILED P
JAN 22 1969
FBI - SAN DIEGO

CITY SAN DIEGO, CALIFORNIA

DATE December 10, 1968

Request of Special Agent in Charge, FBI, SAN DIEGO

FIFTY dollars, and NO cents,

(\$ 50.00), which money is to be paid by me on 12/12/68

to INFORMANT

for information concerning the case entitled MINUTEMEN IS-C (100-12461)

ROBERT DE PUGH Etal - BR (91-3149) WILLIAM CHARLES CLAY - SM-MM
(100-14293) LYLE MANNING - SM-MM (100-14299)

STOCKPILING WEAPONS (157-368)

Services: \$ 35.00 Federal Income Tax Withheld \$ _____

Expenses \$ 15.00

Signed: J. J. [Signature]
Special Agent

Authority (date) Bulet. 12-6-68

Period Covered by Payment 12/1/68 - 12/11/68

Authorization Checked _____

Check Number 14429

Receipts Received 13/13/68 (12/13/68)

Voucher Prepared 1/15/69 Item 6

Date of Actual Payment 12/13/68

By whom SA [Signature]

Informant's File No. 134-914

Approved _____
SAC

170-286-5
134-714-5
SEARCHED _____ INDEXED _____
SERIALIZED _____ FILED _____
JAN 15 1969
FBI - SAN DIEGO

UNITED STATES GOVERNMENT

Memorandum

TO : SA Bone

DATE: 1-13-69

FROM : J. Keyser

SUBJECT: Robert DeRugh (91-3149)

et al -

BR -

OO - KC -

On 12/10/68 SD 1155-C converted to

Sec. Informant - **INFORMANT** - now being contacted

by SA Christensen.

Informant contacted Dec. 18, 1968 and Jan. 3, 9, 10, 13

He has no new info re whereabouts of DeRugh or Keyser.

J

1-91-3149

1-134-914

170-2864

134-914-7

SEARCHED	INDEXED
SERIALIZED	FILED
JAN 13 1969	
FBI - SAN DIEGO	

UNITED STATES GOVERNMENT

Memorandum

TO : SAC, SAN DIEGO (137-1643) (P)

DATE: 12/11/68

FROM : SA C. JORDAN NAYLOR

CI SI R (Prob)

PCI PSI R

SUBJECT: **INFORMANT**

Dates of Contact 10/31, 11/8, 12, 13, 21, 22/ 1968

Titles and File #s on which contacted

ROBERT DE PUGH - BANK ROBBERY
 MINUTEMEN IS - C
 LYLE ...
 STOCKPILING WEAPONS

91-3149
 100-12461
 100-14299
 157-368

Purpose and results of contact

- NEGATIVE
- POSITIVE
- STATISTIC

The following information is being set out under both file numbers 134-New and 137-1643 inasmuch as the Agent has not yet been advised as to whether a new 134 case will be opened in connection with this matter.

Subject furnished a copy of the Minutemen Bulletin dated October 19, 1968 which he advised he had just received in the mail. He noted there was no return address on the envelope and the Post Office date stamp reflected the letter was mailed at San Diego, California. Informant is in continuing contact with BILL CLAY and on October 30, 1968 spent the evening with CLAY and his wife, WALTER HAYWARD and wife at the CLAY residence where they spent the entire evening working on Minutemen records and files. Informant reported discussion at that time regarding possible harassment of all left-wing groups and the selection of specific targets among left-wingers

<input checked="" type="checkbox"/> Informant certified that he has furnished all information obtained by him since last contact.	Rating	Coverage
	SEARCHED INDEXED SERIALIZED FILED DEC 13 1968 FBI - SAN DIEGO	SECURITY AND MINUTEMEN ACTIVITIES

- 1 - ~~137-1643~~ 1 - 91-3149 1 - 157-368 1 - 100-14016
- 1 - 134-New 1 - 100-13978 1 - 100-14061 1 - 100-12461
- 1 - 100-14298 1 - 100-14297 1 - 100-14299 1 - 100-14301

CJN:orb

by Minutemen. They also discussed the possibility of obtaining publicity for Minutemen Front Groups in an effort to build up the morale of Minutemen. The group discussed the organization of a phantom militia to be established as a front for the Minutemen and it was indicated that such names as "The Fox", "Secret American Militia", "Blue Ox Society", and "Swamp Fox" were considered as names for this phantom militia. Informant said the purpose for this phantom militia would be to write letters and conduct other business in an anonymous fashion to harass various individuals and organizations without the identity of the Minutemen being disclosed. Informant said that when CLAY learned he had received a bulletin in the mail he (CLAY) told informant not to discuss the details of the bulletin with anyone. Informant identified WALTER HAYWARD as a white male, age approximately 35 years, height 6' 3", weight 260 pounds, has full beard approximately 1½ inches in length, dark hair, and usually wears a cowboy hat. He has served with U. S. Rangers in Korea and his wife is believed to be a German citizen.

Informant discussed the possibility of an individual identified as MIKE O'HAVER, age about 30, a taxidermist located on Fletcher Parkway, as a possible source of having material printed such as the Minutemen Bulletin. Informant said he is aware that O'HAVER has access to a printing press and believes that he operates the printing press for the Patriotic Society in San Diego. Printing equipment includes offset and linotype machines.

On November 8, 1968, informant advised BETTY HOUGHTON is attempting to sell two printing presses which she has in her possession at an unknown location. Informant said she is attempting to sell these to the editor of the Morning Teaspoon. He said he believes BETTY has recently had a partial nervous breakdown. BETTY has a house guest, FRED HAWES, San Diego 100-14298, who is believed presently separated from his wife who resides in Washington state. Informant said he believes HAWES is paying rent to BETTY HOUGHTON.

Informant said the Peace and Freedom Party has a message information center established at some unknown location and advised that the Minutemen have been using this

message center to relay messages to each other. This phone number used in this connection is San Diego 232-6621. Informant said Peace and Freedom Party Headquarters has made space available to individuals who are organizing themselves under the name of "Friends of the Panthers". He was unable to furnish names of any specific individuals involved in this activity but indicated that the group will possibly use Peace and Freedom Party Headquarters for their activities.

On November 12, 1968, informant advised that recent discussion with BILL CLAY indicated a push toward the phantom militia considering publication of black power propaganda to stir up local white groups. He said the militia will come out with extreme suggestions directed against such people as the John Birch Society and others in an effort to cause right wingers to become indignant against black organizations.

Informant said that the San Diego Mining Association holds periodic meetings at Balboa Park. PAUL RUPLINGER has been invited to speak at the next meeting on November 18, 1968 by WALT HAYWARD, President of the Mining Association.

Informant said the Peace and Freedom Party is making plans to establish a GI Coffee House in San Diego to be used as a front for draft resisters groups and to push anti-war propaganda. He advised that War Resisters League was to meet on November 14, 1968 in front of the Federal Building for a demonstration. (Local authorities notified).

Informant said the local Peace and Freedom Party Message Center had recently been advertising for help and he believed that MIKE VEJVODA was going to volunteer for work to learn the activities of the group. He furnished VEJVODA's telephone number as 449-0136 presently believed to reside in Lakeside or El Cajon. Informant said that he has recently met a DAVE STAFFORD connected with B. C. Enterprises who plans to establish a colony in British Columbia in the near future. He said he feels STAFFORD is

possibly a con artist and will attempt to develop more information about him.

On November 18, 1968, informant furnished DAVE STAFFORD's telephone as 269-2638. He said he has learned STAFFORD reportedly has served time in a federal penitentiary on a weapons charge and is believed to be from the state of Indiana. STAFFORD has interested HOWARD GREENLEAF in his project and a Mr. BAKER, identified as a carpenter in the El Cajon area. The group is going to buy a boat, and a 197 foot gold digging dredge for \$15,000.00 which ship is presently located docked on the bay at San Diego. The ship has sleeping quarters for approximately 30 people. STAFFORD is reportedly selling shares to raise \$500,000.00 in connection with taking a group of about 300 people to British Columbia.

DAVE STAFFORD is described as a white male, age 35 to 40 years, height 5' 10", weight 210 pounds, resides with wife and several children on Darnell Street, near Home Avenue and Highway 94.

On November 21, 1968, informant advised he had been contacted at his residence by JERRY LYNN DAVIS, also known as SAM DAVIS, who indicated he had access to several high explosives and wanted to sell some of these items to informant. DAVIS indicated to informant he had the following items available: One pound charges of TNT at \$2.95 each, One third pound charges TNT \$1.50, blasting caps \$8.00 per hundred, fuse \$2.50 a hundred foot, electric blasting caps no price quoted, carbine ammunition in sealed metal containers with 800 rounds to the container no price indicated, four to ten thousand rounds 9 millimeter shells, three hundred rounds armour piercing shells, fragmentation hand grenades at \$10.00 each. DAVIS advised he was going to give explosives demonstrations in an undisclosed place in the desert in the near future and invited informant to participate. No date yet set. Informant feels he was contacted by DAVIS through DAVIS' association with BILL CLAY. DAVIS indicated that he and his group, not further identified, have been working in the back country and have buried items of ammunition, arms, and food placed at distances of one day march intervals throughout the desert from California to Arizona. Informant

said he feels certain that all sources of material including the ammunition and explosives identified above are obtained by DAVIS through some contact with military sources.

On November 22, 1968, informant advised that he had been recontacted by SAM DAVIS and had placed an order for some one pound and one third pound charges of TNT. He said DAVIS told him that the one pound charges are shaped in such a way that they are capable of cutting a hole through one inch of solid steel. Informant said he also attempted to purchase some of the ammunition offered by DAVIS, however, DAVIS advised that he had already disposed of most of it and would have to wait till he obtained more. Informant will furnish the material purchased by him in an effort to determine origin of these materials and to determine if they are government property.

Informant said he has been invited to attend a meeting of the B. C. Adventure Corporation this coming Sunday night, November 24, 1968, at 7:30 P.M. at the home Dr. and Mrs. CRISCOLA (phonetic) who reside in La Jolla, California. This meeting is to be conducted by DAVE STAFFORD and the group will discuss plans for colonization in British Columbia at a remote area where the group can be protected from communist and other organizations attempting to take over the world. Informant advised that he had been on the dredge barge which is being purchased by the group and stated there is a considerable amount of superstructure on this barge which will have to be removed before it could serve any practical purpose for the group. Informant said he had been to STAFFORD's home and was shown a 44 caliber magnum ruger-blackhawk revolver and two or three rifles which STAFFORD has in his home. STAFFORD drives a 1966 cream colored Chrysler.

Informant said he has recently met a BOB KLEINSCHMIDT (phonetic) described as a white male, age 45, height 5' 8", weight 140 pounds with black hair who resides somewhere in El Cajon. He met this individual at the Mining Council Meeting on November 18, 1968 at Balboa Park and is a close buddy of WALTER HAYWARD's. He said KLEINSCHMIDT works for the Mt. Miguel Hospital District, drives a Ford Bronco and

SD 137-1643

spends a lot of time in the desert prospecting, etc. Informant said there were about 36 people present at the Mining Council Meeting and that PAUL RUPLINGER gave a survival lecture on edible plants to be found in the desert. Informant identified WILLIAM CLAY, MIKE VEJVODA, and BILL HOOVER, a retired military man from Lakeside, as people whom he knew at the lecture.

Informant said LYLE MANNING and FRANK YODUS are planning to open up a store on University Avenue between Vandyke and 42nd or 43rd Street which will be a swap shop selling guns, ammunition, and other items. The store is to be identified with the name of Hanging Tree Swap Shop. Informant said YODUS is believed to be retired from the Navy and previously traveled with informant and MANNING to a gun show in Yuma, Arizona, recently. YODUS is described as a white male with a small build, age 45, height 5' 8", light complexion, believed to be the local franchised dealer for Liberty Arms Company.

Informant said he has learned that HAYWARD resides at Riverview Street in Lakeside, California, and has a mimeograph machine located in his bedroom. He was not able to furnish the specific address.

Informant advised he has no certain knowledge of current income for BETTY HOUGHTON, but believes she is receiving financial assistance from TROY HOUGHTON's mother. It is also believed she continues to receive some contributions from Minutemen regarding sales of Minutemen literature and income from FRED HAWES, a boarder at her home. Informant said he has no information regarding any credit, bank, or charge accounts for BETTY HOUGHTON.

The name of J. D. BENNETT is not familiar to informant and he knows no one who has attended the National Convocation at Tuscaloosa, Alabama, during October, 1968.

Date

6/30/72

INFORMANT

(170-286)

Title and Character of Case

INFORMANT (170-286)

Date Property Acquired	Source From Which Property Acquired
6/30/72	SD-1155-E

Location of Property or Bulky Exhibit	Reason for Retention of Property and Efforts Made to Dispose of Same
Firearms vault	Retain temporarily until disposition decided upon.

Description of Property or Exhibit and Identity of Agent Submitting Same

Submitted by SA EARL M. PETERSEN

- 1 - Browning Machine Gun, Caliber 50M2, US No. 32846 Mfg. by Colts Patent Firearms Mfg. Co., Hartford, Conn. (This weapon completely in a disassembled condition. Barrel has been cut off by welding torch. Not in working condition)
- 1 .38 caliber silencer no brand name but with Pat. Pending and number 96 stamped on it. Blued steel.
- 1 Sawed off shotgun barrel and stock (also sawed off) from Sears Roebuck model ~~300~~ 100.100 shotgun. No serial number. Barrel 13 1/4 inches long.
- 2 Rifle grenade launchers. No identifying marks.

Sent to Bureau by RA Express for destruction 5/3/73
See letter dated 4/30/73 Serial 141

SEMIANNUAL INVENTORY CERTIFICATION TO JUSTIFY RETENTION OF PROPERTY (Initial and Date)

Field File # 170-286 1 B 1

SEARCHED	INDEXED
SERIALIZED	FILED
JUN 30 1972	
FBI - SAN DIEGO	

SSC Request 1/20/76
Item 3 (Re: Secret Army Organization)
Volume IV

Retain

UNITED STATES GOVERNMENT

Memorandum

TO : SAC, SAN DIEGO (157-2815)

FROM : SUPV. ANTHONY J. MALONEY, JR.

SUBJECT: SECRET ARMY ORGANIZATION (SAO)
EM - SAO

DATE: 12/4/75

At 10:15 AM, on 12/4/75, MILTON VIORST telephonically self-described himself as a free-lance writer for a literary publication known as the New York Review, who is stationed in Washington, D.C. and who is temporarily staying at the Mission Valley Inn, Room 359, San Diego, telephone 298-8281.

VIORST volunteered that he is aware of the provisions of the Freedom of Information Act and he does not feel they apply to the purpose of his call. VIORST said he is interested in doing a "Human Interest" magazine article on the SAO and in connection therewith requested authorization to interview SAs PETERSEN and NAYLOR concerning the SAO.

VIORST is aware there is a civil suit pending against some Agents in the San Diego Division as a result of the SAO and said he would try to refrain from asking any questions which might tend to prejudice the Agents' rights in the civil suit.

VIORST was courteously informed that circumstances caused his request to be denied.

On 12/4/75, the above facts were telephonically furnished for informational purposes only to Mr. PERKS of the External Affairs Division at the Bureau and who agreed with the decision and felt no correspondence was necessary to the Bureau in this matter.

3 - San Diego

AJM:ejt

M(3)
aj

#5

157-2815-431

SEARCHED	INDEXED
SERIALIZED	FILED
DEC 4 1975	
FBI - SAN DIEGO	

rlw

Petersen
Naylor



Date prepared

2/11/75

Date received

4/1/75

Received from (name or symbol number)

150 257-E

INFORMANT

Received by

SA Earl M. Peterson

Method of delivery (check appropriate blocks)

in person

by telephone

by mail

orally

recording device

written by Informant

Locally furnished and reduced to writing by Agent:
Date

Date of Report

2/1/75

Dictated

to

Date(s) of activity

1/17/75

1/31/75

Transcribed

Authenticated
by Informant

2/1/75

Short description of activity or material

Info re Ron Eddy + George Mitchell
Lover

File where original is located if not attached

170-512A

* INDIVIDUALS DESIGNATED BY AN ASTERISK (*) ONLY ATTENDED A MEETING AND DID NOT ACTIVELY PARTICIPATE.
VIOLENCE OR REVOLUTIONARY ACTIVITIES WERE NOT DISCUSSED.

Information recorded on a card index by

on date

Remarks:

- 1-170-512A - 366
- 1-157-152 (Ron Eddy)
- 1-157-3487 (Dennis Low)
- 1-157-2898 (Thomas F. Knight)
- 1-157-2610 (Mickey Wakefield)
- 1-157-2545 (Ray Wilson)
- 1-157-201 (Huselt Smith)
- 1-170-286 (Hodfrey)
- 1-157-3087 (Joe Drisker)
- 1-157-4557 (Tom Metzger)
- 1-157-4597 (NCC)
- 1-157-3017 (George Hoover)
- 1-157-2815 (SAO)

EM P: EG

(13)

Block Stamp

157-2815-425

SEARCHED	INDEXED
SERIALIZED	FILED
FEB 10 1975	
FBI - SAN DIEGO	

SUBJECT: Ron Eddy; George Mitchell Hoover.

It has been ascertained that at this time Ron Eddy of Poway is not interested in trying to form or lead any type of security force for any right-wing extremist group. When asked by James K. Warner of Los Angeles (via Dennis Loso of Escondido) if he would do this, Eddy stated that he would like to see the formation of a Security Force with teeth in it but does not consider himself to be enough of a leader to do it himself.

While declining to lead a Security Force, Eddy did say that the only way to stop FBI infiltration of rightist groups would be for one of the infiltrators to "wind up in the river" someday. Eddy is positive that Tom Knight's San Diego unit of the Nazi Party has a regular FBI infiltrator. The only three men of whom he is not suspicious are Mickey Wakefield, Ray Wilson and Gerald Smith. Said Eddy, "Those three men dropped out of the thing and so I figure they're okay but you can bet that the fink is still in there pushing".

Loso said that the whereabouts of people like Barry Godfrey should be learned and they should be telephoned and intimidated. Eddy said he thinks such intimidations would be a waste of time and that people like Godfrey should be killed. Mickey Wakefield of San Marcos went along with Eddy's suggestion. Ron Eddy also mentioned having had an encounter with an FBI agent named Peterson in San Diego but did not elaborate.

Eddy firmly believes that any man who commits himself to one organization in the Far Right should not be involved with others. He says he would be very suspicious of anyone who is. He is also somewhat suspicious of Tom Knight. He says that Joe Brinker gave Knight the name of a man interested in Nazism and two weeks later the FBI interviewed the man. Also, Eddy wonders how Knight saved his federal job in the face of his continued Nazi activities. Eddy feels that any regular rightist extremist who stays on with the Nazi Party now must warrant heavy suspicion of being an FBI informant.

On Friday night, January 31, 1975 Ron Eddy met Tom Metzger of Fallbrook for the first time. Metzger showed Eddy some pictures and slides of New Christian Crusade activities and the two seemed to hit it off pretty well. Metzger told Eddy, Wakefield and Loso of a visit he received at his home on January 17, 1975 from agents of the Internal Revenue Service. He said the agents were nervous.

George Mitchell Hoover

Here is one last bit of information. The New Christian Crusade people are very concerned about the imprisonment of George Hoover of the Secret Army Organization. At one of their banquets the NCC had four unoccupied places set at the table which were in honor of four men whom they hold to be absent heroes. These four men were Joe McCar George Hoover, Charles Lindbergh and a man named R. Miles.

Anyway, it has been learned that a man whom Tom Metzger knows is going to take a dossier of the Hoover case to some congressman in Washington, D.C. who is part of a committee currently scheduled to investigate the FBI. The dossier consists of newspaper clippings and other material pertaining to Hoover's activities in the SAO, his arrest, conviction, appeal, etc. They are hoping to stir up a big publicity stink to give the FBI a bad name due to Barry Godfrey's activities and in so doing hope to effect an eventual release of Hoover from prison. By the way, the NCC people do not refer to Hoover by his correct name. For some reason they all call him Mickey Hoover. That is about all for now. I hope this will be of some help to you.

Sandman 2-1-75

INFORMANT

Date prepared

12/26/74

Date received

12/14/74

Received from (name or symbol number)

SA 2157-C

INFORMANT

Received by

SA Earl M. Peterson

Method of delivery (check appropriate blocks)

in person by telephone by mail orally recording device written by Informant

If orally furnished and reduced to writing by Agent:

Date

Dictated _____ to _____

Transcribed _____

Authenticated by Informant 12/9/74

Date of Report

12/9/74

Date(s) of activity

12/8/74

Brief description of activity or material

NCC picketing at border 12/8/74

File where original is located if not attached

170-512A

* INDIVIDUALS DESIGNATED BY AN ASTERISK (*) ONLY ATTENDED A MEETING AND DID NOT ACTIVELY PARTICIPATE. VIOLENCE OR REVOLUTIONARY ACTIVITIES WERE NOT DISCUSSED.

Information recorded on a card index by _____ on date _____

Remarks:

- 1-170-512A-350
- 1-157-4547 (NCC)
- 1-157-4557 (Tom Metzger)
- 2- Los Angeles (Rich Norton XRM)
- 1-157-3138 (Vic WALTON)
- 1-157-2521 (Bill MILLER)
- 1-157-28 (NSWOB)
- 1-157-1254 (Fox Rebellion Committee)
- 1-157-3220 (National States Rights Party)
- 1-157-4168 (MCC)
- ①-157-2815 (SAO)
- 1-157-3498 (Wesley Bounds)

EMB: g

(13)

Further dissemination left to receiving offices.

Block Stamp

157-2815-424

SEARCHED _____	INDEXED _____
SERIALIZED _____	FILED _____
DEC 30 1974	
FBI-SAN DIEGO	

SUBJECTS: NCC picket border; thoughts on NCC; Weir's wounds.

Here is some more information regarding the National Christian Crusade picket which took place at the U.S.-Mexico border in San Ysidro on December 8, 1974. Of the 16 men who took part in this uniformed picket, 10 were from the San Diego area and 6 were from Los Angeles. It was mistakenly stated in yesterday's report on this demonstration that 10 of the men were identified. In reality, 11 were fully identified, 1 partially identified, and 4 unidentified. The 4 unidentified were all from L.A.

Also, the members of this picket were divided into two contingents, Los Angeles and San Diego. Commanding the San Diego group was Tom Metzger of Fallbrook and in charge of the L.A. men was Rick Norton. Also, Norton was in overall command of the operation.

Two other things which were not mentioned in the earlier report are as follows. First, Norton told his men that if attacked, they should form into a back to back square and "let her rip". Also, after the conclusion of the demonstration, Norton conducted a very brief prayer.

As to my thoughts on the NCC, I feel that this group has the potential to command much more support from a broader base of people than most of the right-wing extremist groups. It seems significant to this informant that men like Vic Walton and Bill Miller would actually get up the nerve to take to the streets in uniform, a thing they never did for the Nazi Party although both supported it.

It is also noteworthy that the NCC was able to draw supporters from so many other extremist groups. Taking part in this demonstration were elements from the Nazi Party, the Tax Rebellion Committee, the National States Rights Party, the Ministry of Christ Church and the old Secret Army Organization.

Also, this group does not automatically get adverse responses from the public in the streets. Indeed, many passersby indicated their support for the group's aims in the demonstration of the 8th. The leadership is more intelligent and more approachable than that of groups like the NSWPP or MCC. They more easily establish a good rapport with the public in general and are not so blunt in stating their racism.

Wesley Rounds

It has been learned that Wes Rounds is losing money on his Californian Motel in Escondido. He is seriously considering purchasing a motel in which closed circuit television featuring X-rated movies is present. He says this is a real money maker and he just might be compelled to go that route.

That is all for now.

Anderson 12-9-74

INFORMANT

3121

SAC (157-2815)

8/6/74

SA Earl M. Petersen

Jerry Busch

EM-SAO

The attached letter was obtained from Detective Les Oberlies San Diego Police Department, ISU, on 7/19/74.

The letter is self explanatory and indicates that Jerry Busch is furnishing information to the Door. He probably furnished the information that the Door has printed in the past about the Secret Army Organization, Barry Godfrey and the right wing in general.

1 - 170-286 (Godfrey)
① - 157-2815 (SAC)
1 - 100-14948 (Door)
EMP:emp

(5)

Note: Letter from LA in 170-286 dated 7/30/74 reflects letter found in jacket belonging to one Louis Tackwood (former informant for LA PD who turned very sour, sued etc.)

P.D. INFORMANT

157-2815-419

SEARCHED	INDEXED
SERIALIZED	FILED
AUG 6 1974	
FBI-SAN DIEGO	

Bellingham, Wn, 98225
July 5, 1973

Mr. Bill Rivin
Editor
The Door
P.O. Box 2039
San Diego, Calif. 92112

Dear Bill,

Well, here it is. Please excuse
the delay, also my wretched handwriting.
I have, for the time being, been separated
from my typewriter (a small matter of \$500
ass. to the workshop). There is only one
item regarding the 9mm. Radium, omitted.
That one I didn't feel safe in putting on
paper. So here goes the Godfrey thing:

Godfrey Data

1. I first saw, but was not introduced to Howard
Barry Godfrey at the Stardust Motel San
Diego Gun Show in September, 1969. A
number of persons, among them Mr. George
Hoover and myself, were manning the
N.A.R.B.A. booth at the show. Godfrey
came frequently to this booth during the
three days of the show. On these occasions
he would "walk through the show" with Mr.
Terry Lynn Davis, holding

the content of these conversations

2. In November, 1919 I was asked to go on a "soft penetration," for intelligence gathering purposes, with Godfrey. I was asked to make a report on Godfrey's conduct and ability. Godfrey was introduced to me only as "Barry".

We met at a San Diego tavern, the Arrow Club, on El Cajon Blvd. From there we drove to the Lake Elsinore area and visited the home of an elderly gentleman, whose name and supposed importance I have forgotten.

For someone who was supposed to be an "intelligence type", Godfrey impressed me as ill-fitted for the role. He alternately exhibited physical traits or gestures — particularly his eyes and hands — which I would classify as; 1) sly or sneaky, 2) nervousness or cowardice and 3) awareness of personal guilt. All of these, despite the fact we were breaking no laws, doing no harm and in the house at the invitation of its owner.

Following the "interview", we left the

subject's house and I discovered that we were being followed. Reluctantly - and that's the only way I can describe Godfrey's attitude - he followed my instructions to try to shake our surveyors. Normally, I am fairly competent in breaking a surveillance, but this time it didn't work. Even though we doubled back on the car following us and pulled into a service station, the car was behind us again when we entered the freeway Southbound. Godfrey "panicked" then, increasing his speed and driving directly to San Diego and to a Chinese restaurant where we met his superior, Bill Clay.

In retrospect, wherein we all become geniuses, I can conclude that the surveillance team following us that night consisted of Special Agent Petersen or Christiansen and other FBI storm troopers. That Godfrey's reluctance and panic came from his fear of doing anything counter to his instructions from his employers (the FBI).

3. During the period of November, 1969 to Summer of 1971, Howard Godfrey frequently came to Gunsmoke Ranch on weekends

When various forms of target shooting were practiced for recreation. On these visits, which were always brief - lasting less than an hour - he would take Mr. Hoover or Mr. Jerry Lynn Davis aside for quiet conversations. During these visits, he would "act" as if he did not know Bill Clay or myself.

It was during this time that I learned he had been appointed "Director of Intelligence" for the San Diego area sector of the Minutemen.

4. In August of 1971, Godfrey came to my apartment and requested I verify addresses and phone numbers for a series of names he had on 3x5 note cards. He then proceeded to try to "recruit" me for "his intelligence network".

5. It was also during June, July or August of 1971 that both Godfrey and Donald Signetti - posing as "Don Simms" - visited Gunsmoke Ranch and, although supposedly "not knowing each other", they spoke together, on at least one occasion, in a manner similar to the conversations Godfrey had previously held with Mr.

Hoover and Mr. Davis.

Following these "casual conversations" between two spectators at a shooting match, in October, 1921, Godfrey came up with bizarre ideas to "take care of these Red punks" if the Republican Convention was held in San Diego. Also, a number of us received literature on a new group, the SAO. Mr. Flenny and I were given specific instructions not to involve ourselves in any way with the SAO. Mr. Flenny continued to receive SAO literature (unmasked) although I did not.

Some of Godfrey's ideas included:

1. The use of massive dosages of LSD, cyanide or strychnine introduced into the punch at Anti-war group meetings.
2. Bombing of VVAW headquarters, the Guild theatre and several porno shops.
3. Bombings of the homes or offices of Anti-war leaders.
4. Kidnaping or assassination of Anti-war leaders and activists.
5. Fire bombing of vehicles and other property belonging to Anti-war activists.

NOTES: Our general attitude toward Godfrey

and his proposals at that time was;
"He's a fucking nut!"

7. By November and December of 1971, Godfrey's "ideas" had solidified — along with the decision to hold the Republican Convention in San Diego. His other ideas having been rejected (I have a strong suspicion that some of them were carried out or attempted by Godfrey) he now proposed that someone construct radio controlled, Freeflight model airplanes to carry payloads of HE and white phosphorous, to be flown over Vacation Island and detonated. When Mr. Hoover, Mr. Fleury and I heard of this idea we rejected the possibility out of hand.

Godfrey likewise attempted to involve others in a conspiracy to manufacture a similar aircraft, loaded with TNT or C-4 plastique, to be flown into Air Force 1 as it landed at Lindberg Field or El Toro Marine Air Base at San Clemente. When I heard rumors of this, I expressed the opinion that Godfrey had lost his mind to ever suggest anything as insane as an attempt on the life of the President. I further stated that if I ever received information that he was actually proceeding, I would report it to the Secret Service.

Others, including Mr. Hoover, expressed the same attitude. In retrospect, it appears that those comments must have found their way to Godfrey.

During this time I also learned Godfrey was "San Diego leader" of the S.A.O.

8. In December, 1971, Godfrey attempted to get someone to assassinate Dr. and Mrs. Naves, Ned von Valkenberg, Peter Bannan and other Anti-war leaders. Again he was refused by everyone he contacted.

9. On January 6, 1972, the attack was made on Peter Bannan's home by Godfrey and someone else, whose identity as yet remains unknown.

10. In February, 1972, on two occasions, shots were fired at Mr. Richard Fleury at his home. (He, like Hoover and I, had refused to go along with any of Godfrey's wild ideas.)

My apartment in San Diego was under surveillance by someone and I was fired at on one occasion where I was staying out of sight. Godfrey told Mr. Hoover that, "Bannan's People figure it was you and Busch who took the shots

... in my name in connection with the ... put
out a contract on you []

No sooner was this said than Godfrey began to pressure me to return to my apartment. (He had told Mr. Hoover not to tell me about the "contract" or the surveillance, but Mr. Hoover did.) I reflected that outside of Mr. Fleury, who had also been shot at, Mr. Hoover, his employer and my mother, only Godfrey knew where I was staying. I thus concluded it was he and/or members of his (by his claim) forty person "intelligence" network who had fired the shots at Mr. Fleury and ~~myself~~ myself.

Therefore, on March 2, 1972, I left San Diego County and the United States in fear of my life. (One can not, after all, protect oneself from a hidden assassin!) In light of what has transpired since, I have remained out of the area ever since.

Sure hope this will help Bill.

Best of luck,
Jimmy Burch

P.S. Bill, just talked today (Friday, 7-6) with Wanda Trout of L.A. Times. Please send her a copy of this. J.B.

Date prepared

6/17/74

INFORMANT

Date received

6/17/74

Received from (name or symbol number)

SD 2157-C

Received by

SAG in Citation

Method of delivery (check appropriate blocks)

in person by telephone by mail orally recording device written by Informant

If orally furnished and reduced to writing by Agent:

Date

Dictated _____ to _____

Transcribed _____

Authenticated by Informant 6/13/74

Date of Report

6/13/74

Date(s) of activity

Brief description of activity or material

Inform MCC, Posse Comitatus
* individual

File where original is located if not attached

170-512A

* INDIVIDUALS DESIGNATED BY AN ASTERISK (*) ONLY ATTENDED A MEETING AND DID NOT ACTIVELY PARTICIPATE. VIOLENCE OR REVOLUTIONARY ACTIVITIES WERE NOT DISCUSSED.

Information recorded on a card index by _____ on date _____

Remarks:

- (/) 170-512A - 281
- () 157-4323 (AFCU)
- () 105-6730 (AL FATAH)
- () 105-7470 (JDL)
- () 157-4340 (LIBERTY AMENDMENT)
- (/) 157-4168 (MCC)
- (/) 157-28 (NSWPP)
- () 157-4024 (ELLEN ADAMS)
- () 157-4448 (AL ALDINGER)
- () 157-7018 (JOSEPH BENINTENDE)
- (/) 157-2527 (HARRIET BRINKER)
- () 157-3484 (JANET BRINKER)
- (/) 157-3087 (JOSEPH BRINKER)
- () 157-4019 (ROBERT BROWN)
- () 157-4076 (BERT CAMPERAT)
- () 157-2897 (WILLIAM DOMASK)
- (/) 157-152 (RON EDDY)
- () 157-4449 (JOHN FINN, JR.)
- () 157-3300 (P.T. GAVIN)
- () 157-4269 (KENT GEDDIS)
- () 157-4434 (NELLY JOHNSON)

Index to 157-4168
Posse Comitatus
JACK FREDERICK

Block Stamp

157-2815-417

SEARCHED	INDEXED
SERIALIZED	FILED
JUN 17 1974	
FBI - SAN DIEGO	

EMC: g

(17)

- (/) 157-4407 (Dr. CHARLES WELT KENDALL)
- () 157-2893 (THOMAS FRANKLIN KNIGHT)
- () 157-4450 (ROBIN LIPPERT)
- (/) 157-3487 (DENNIS LOSO)
- () 157-4131 (CHARLES MARTIN)
- (/) 157-2521 (DAVID "BILL" MILLER)
- () (ANN NATTER)
- () 157-4273 (WILLIAM PROBERT)
- () 157-4553 (ROBERT RAYBURN)
- () 157-3498 (WESLEY ROUNDS)
- () 157-4274 (Mr. KARL SACK)
- () 157-4275 (Mrs. KARL SACK)
- () 157-4252 (CARL SCHMIDT)
- () 157-4271 (DONALD SEABURG)
- () 157-4029 (ART SHOOT)
- () 157-4546 (J. ANDREW SIMPSON)
- (/) 157-201 (GERALD SMITH)
- () 157-4248 (GEORGE UDBARY)
- () 157-4266 (MARY UDBARY)
- () 157-2610 (MICKEY WAKEFIELD)
- (/) 157-3138 (VICTOR WALTON)
- () 157-2524 (GERALDINE WATSON)
- () 157-2545 (RAY WILSON)
- () 157-2506 (JACK ZIMMERMAN)
- () 157-4447 (BARBARA HUTCHINSON)
- () 157-4545 (CHANCEY CURR)
- () 157- (Bernard Dower)
- () 157-4023 (ARNOLD DRESSEN)
- () 157-3169 (DONNA LEE HARTLEY)
- () 157-3170 (CALVIN FOX)

- 1 - 157-3121 (Busche)
- 1 - 157-2933 (McDade)
- ① 157-2815 (SAO)
- 1 - 157-3017 (Horro)
- 1 - 157- (George Metzger)
- 1 - 157- (Joe Reedy)

SUBJECT: Posse Comitatus.

During the last two years this informant has spent a great deal of time studying the tactics, personalities and stated goals of both the National Socialist White People's Party and the Ministry of Christian Church. Until recently I considered the NSWPP to be more of a threat to the security of peace and law in the United States than the MCC but events of recent months have caused me to change my view of these groups about 180 degrees. I now regard the MCC to be a far greater threat than the NSWPP is likely ever to become.

The main reason for my change of relative attitudes toward these groups has been the increased preoccupation of certain MCC members with Posse Comitatus. Also known as the Christian Posse Association, this organization serves as the paramilitary arm of the MCC. The goals of its most ardent activists seem to be very similar to those of the Nazis but their tactics are quite different. Instead of wrapping themselves in the Swastika, they uphold the Christian Cross as their symbol. Unlike the head-on street clashes which many of the Nazis seem to relish, members of Posse Comitatus generally tend to prefer being secretive and clandestine in their operations. They generally seem to fancy themselves to be revolutionaries and as fanatical as some of them appear, I believe a potential exists for the Posse to become a truly revolutionary group.

Dennis Loso was at one time a major financial supporter of the NSWPP. He has renounced that group since 1972 but not because of its purposes but only because he considers it to be ineffective. He is now a dedicated supporter of the MCC and its national leader, William Gale. Loso almost never misses an MCC meeting in San Diego, frequently visits the Glendale meetings of MCC, and more recently attended the MCC seminar at Manassa Ranch in Mariposa. If Loso is not already an officer within Posse Comitatus, then the potential certainly exists for him to become one. Loso is also an admirer of Jack Fredericks and was just elected to the San Diego County Central Committee of the American Independent Party.

Welt Kendall, another ex-Nazi supporter who has turned to the MCC, is also a potential activist for Posse Comitatus. Kendall attends perhaps 2/3 of Gale's meetings in San Diego and is definitely not bothered by the prospect of using violence to attain political goals. He once suggested that Sheriff John Duffy of San Diego County should be assassinated.

Jerry Busch, a.k.a. Mark Roberts, is another man to watch. He is a dedicated supporter of the MCC and stresses the importance of MCC members

outside the realm of normal correspondence. Two-way radio contact seems to be his favorite. Busch once stated his desire to murder Deputy District Attorney Hewicker of San Diego. Busch is very suspicious and paranoid of everyone.

Stan McDade, former Secret Army Organization affiliate, is definitely in the Posse Comitatus picture. He occasionally attends MCC meetings in San Diego. A friend of George Hoover, McDade made a feeble write-in campaign for sheriff against John Duffy but it never amounted to much. About the only support he received came from affiliates of the Posse.

Joe and Harriet Brinker are almost sure to be members of Posse Comitatus. Long time supporters of the MCC, they never miss a meeting or other MCC activity and have often driven long distances across country just to participate in such events. Harriet is definitely the brains of this pair. In spite of their very radical political stance, however, this informant does not consider either one of them to be capable of a premeditated act of violence.

George Metzger seems to be very deeply involved in Posse Comitatus. He is an organizer, a "take charge" man and a pretty good speaker both in private and before groups. He is not dynamic but speaks carefully, deliberately and with an air of sincerity and believability. Certainly his actions should be observed.

Joe Reedy is a close associate of Metzger. He seldom has much to say and appears merely to be a faithful follower who would be willing to go along with whatever the others decide.

Bill Miller is very closely tied with the MCC and has been for a long time. However, he is definitely not the violent type. He tapes every one of Gale's sermons and never misses a meeting. Gerald Smith kicked Miller out of the NSWPP because he considered him to be cowardly and more interested in promoting the MCC than the NSWPP.

Ron Eddy is a man who owes allegiance to no particular group or leader but who could very likely become involved in a group like Posse Comitatus. He has been a long time supporter, if a sporadic one, of the NSWPP. At one time Eddy was a Gale follower but he has had nothing to do with the MCC since 1972 because he now considers Gale to be a phony. I am sure that Eddy would have no scruples at all about assassination if he thought the chances of getting away with it to be feasible. He is distrustful of organizations but just this very night stated that if any good is to be done, then we must have a certain amount of organization. You can't just have a bunch of individuals running around doing

Eddy stated, however, that he is very distrustful of anyone whom he has not known for a very long time and would definitely do some extensive checking into a person's background before trusting him as a confederate in any terrorist activity. Eddy seems to enjoy violence but he is also a clever, intelligent man and should never be underestimated. I regard him as being one of the most dangerous people named in this report even though I do not believe him to be a member of Posse Comitatus as yet.

Vic Walton is another figure who is likely to have a hand in the organization of Posse Comitatus in San Diego County. This attorney, in this informant's opinion, presents no threat of physical violence whatever but he serves as a sort of liaison man between the various right-wing extremist groups in the Southern California area. He is intelligent and seems to be fairly well off financially. Through him many others can be reached as Walton has been involved with people in the NSWPP, the MCC, the SAO, Comparet's group and virtually any other extremist outfit in the right-wing which one might think of in this area.

I hope this report will give you some idea as to the current status of Posse Comitatus in San Diego County. At least I believe it to be a fairly accurate description of some of the prime-movers of Posse Comitatus as of the present. Due to the more underground nature of this group, it is more difficult to keep tabs on than is the openly Nazi Party. However, as this organizational arm of the MCC makes the attempt to establish itself as a force to be reckoned with and to consolidate whatever power it might gain, certain characteristics of it are bound to surface and become more clear. This informant will do his best to learn as much about this emerging group as quickly as possible and to relay the information to you as accurately as can be done. One thing seems to be very certain and that is that San Diego County seems to be extremely fertile soil for the flourishing of a group like Posse Comitatus. That is all for now.

Sandman 6-13-74
INFORMANT

Date received

4/15/74

from (name or symbol number)

SD 2448-PE

INFORMANT

ived by

S. Earl B. Peterson

Method of delivery (check appropriate blocks)

in person by telephone by mail orally recording device written by I

If orally furnished and reduced to writing by Agent:

Date

Date of Report

4/15/74

Dictated

4/16/74

to Sue Fox

Date(s) of activity

3/28/74

Transcribed

4/8/74

Authenticated by Informant

Brief description of activity or material

MCC meeting 3/28/74 - SA

File where original is located if not at

170-544A

* INDIVIDUALS DESIGNATED BY AN ASTERISK (*) ONLY ATTENDED A MEETING AND DID NOT ACTIVELY PARTICIPATE IN VIOLENCE OR REVOLUTIONARY ACTIVITIES WERE NOT DISCUSSED.

Information recorded on a card index by _____ on date _____

Remarks:

- (/) 170-544A - 10
- () 157-4323 (AFCJ)
- () 105-6730 (AL FATAH)
- () 105-7470 (JDL)
- () 157-4340 (LIBERTY AMENDMENT)
- (/) 157-4168 (MCC)
- () 157-28 (NSWPP)
- (/) 157-4024 (ELLEN ADAMS)
- () 157-4448 (AL ALDINGER)
- () 157-3018 (JOSEPH BENINTENDE)
- (/) 157-2527 (HARRIET BRINKER)
- (/) 157-3484 (JANET BRINKER)
- (/) 157-3087 (JOSEPH BRINKER)
- () 157-4019 (ROBERT BROWN)
- () 157-4076 (BERT CAMPERAT)
- () 157-2897 (WILLIAM DOMASK)
- () 157-152 (RON EDDY)
- () 157-4449 (JOHN FINN, JR.)
- () 157-3300 (P.T. GAVIN)
- () 157-4269 (KENT GEDDIS)
- () 157-4434 (NELLY JOHNSON)

INDEX TO 157-4168
 Christian Defense League
 CALIFORNIA RAIDERS
 Colonel WILLIAM GALE
 (BACKGROUND)

TAX EXPO 4/5-6/74

Further dissemination left to receiving office.

- 1- 170-286 (Hoofing)
- 2- LOS ANGELES (157-7775) (AM)

EMB: of (19)

Block Stamp

157-2815-416

SEARCHED	INDEXED
SERIALIZED	FILED
APR 1 1974	
FBI - SAN DIEGO	

- () 157-4407 (F. CHARLES WELT KENDAL)
- () 157-2898 (THOMAS FRANKLIN KNIGHT)
- () 157-4450 (ROBIN LIPPERT)
- () 157-3487 (DENNIS LOSO)
- () 157-4131 (CHARLES MARTIN)
- (f) 157-2521 (DAVID "BILL" MILLER)
- (f) 157-4443 (ANN NETTER)
- () 157-4273 (WILLIAM PROBERT)
- () 157-4553 (ROBERT RAYBURN)
- () 157-3498 (WESLEY ROUNDS)
- () 157-4274 (Mr. KARL SACK)
- () 157-4275 (Mrs. KARL SACK)
- () 157-4252 (CARL SCHMIDT)
- () 157-4271 (DONALD SEABURG)
- () 157-4029 (ART SHOOT)
- (f) 157-4546 (J. ANDREW SIMPSON)
- () 157-201 (GERALD SMITH)
- (f) 157-4248 (GEORGE UDBARY)
- () 157-4266 (MARY UDBARY)
- (f) 157-2610 (MICKEY WAKEFIELD)
- (f) 157-3138 (VICTOR WALTON)
- () 157-2524 (GERALDINE WATSON)
- () 157-2545 (RAY WILSON)
- () 157-2506 (JACK ZIMMERMAN)
- () 157-4447 (BARBARA HUTCHINSON)
- () 157-4545 (CHANCEY CURR)
- () 157- (Bernard Dower)
- () 157-4023 (ARNOLD DRESSEN)
- () 157-3169 (DONNA LEE HARTLEY)
- () 157-3170 (CALVIN FOX)
- 1 157-4446 (JONATHAN WEST)
- 1 - 157-3001 (Jenny Lynn Davis)
- ① 157-2815 (SAO)

Report by DON CLARK

INFORMANT

4/5/74

Meeting of Colonel WILLIAM GALE at
O'Neira Hall on the Evening of
March 28, 1974, San Diego, California

Approximately 75 persons were present at that meeting. It included, among others, GEORGE UDVARY, VICTOR B. WALTON, MICKEY WAKEFIELD, J. ANDREW SIMPSON, ELLEN ADAMS, BILL MILLER, JONATHAN WEST, JOE BRINKER, HARRIET BRINKER, JANET BRINKER, Colonel WILLIAM GALE, ANN NUTTER, and others who are very old and very inactive. There were a number of individuals present who are as yet unknown to me.

GEORGE UDVARY does not seem to have made his move yet--permanent move out of the area. He's still in process, I believe, as best I can tell at this time. MICKEY WAKEFIELD came down from Escondido, was hoping to run into some of his para-military friends, one or two of whom did not evidently arrive. He did run into VICTOR WALTON who he is close to. BILL MILLER was there and very involved--on the surface at least. ELLEN ADAMS was distributing literature. JOE and HARRIET BRINKER came in from Escondido and of course are primarily responsible for putting on that monthly meeting and so they were working with that.

There was security that night--more so than would ordinarily be expected. A fellow by the name of DENNIS was inside with a 23-channel, five-watt Citizens Band walkie-talkie, Realistic brand, sold by Radio Shack. He kept monitoring another individual whose name I do not have who was outside. He had a two or three channel Citizens Band walkie-talkie, Midland brand, and they were checking to see if anyone would give them any trouble. This was because of a publication that indicated where their meeting would be held. They didn't indicate what they would do if such trouble arrived.

Colonel GALE discussed an article on himself and the identity movement as written up in Volume V, Issue 14, of a bi-monthly publication, called the San Diego Door. I believe that's a March, 1974 issue. Colonel GALE read directly from the article and made comments and corrections as he went.

He said, now I will read--follow this and read as much as possible that seems relevant. He read from the article: "But the public meetings are only part of the package. Whenever GALE speaks, he recruits followers into the para-military part of his organization. That part is called 'Identity' and has so far incorporated many old Minutemen and secret army elements in Southern California."

To that, Colonel GALE indicated that "Identity" was the name of his church publication--he thought it was

very humorous that they thought it was something else.
The term is used to describe their philosophy.

The para-military part of their operation is under such titles as the "Christian Posse Association."

I will make another quote here from the publication: "JERRY LYNN DAVIS, the ex-head of the SAO in California, has been reported at GALE's public meetings." According to MICKEY WAKEFIELD who was sitting next to me during this meeting, DAVIS had not, as far as he knew, ever been to a San Diego meeting.

Another quote Colonel GALE made: "Identity is organized in similar fashion to other underground organizations--small cells communicate through a series of intermediaries and blind post office boxes." Colonel GALE did not comment further; however, the mailing network for the national tape groups, the Christian Posse Association groups, and the amateur radio network are the primary communication links of GALE's group.

Another quote Colonel GALE made from the article: "In San Diego, GALE can be heard speaking to his congregation on the fourth Thursday of every month at the O'Neira Club on Holly Street" or something of that nature "between 34th and 35th Streets, one block south of Adams Avenue." The street was incorrectly quoted--it's Hawley, and Colonel GALE made an observation on that, indicating he thought the information was transferred to the person at this publication

by telephone and that he figured, he had that all figured out that way because the person must have misunderstood the name and got it wrong.

The next quote from the publication: "According to one law enforcement source, Identity has about 50 members in the San Diego area, including members of the San Diego Sheriff's Department and reserve police officers." Colonel GALE indicated support from and for law enforcement--indicated he has an assistant pastor in Glendale who has an important position in the Los Angeles County Sheriff's Office, and that he claims support from a number of law enforcement areas.

Another quote he indicated: "As for GALE, he pretends to be a minister of his church and operates through it as his front. GALE was one of the driving forces behind the militant Christian Defense League (CDL) in the 60's. He had formed the small California Rangers in the late 50's. The California State Attorney General's Office described the Rangers as," then they put a quote in here, in this article, " 'A secret underground guerrilla force, linked with other non-military organizations by a common ideology and leadership.' "

Colonel GALE indicated at this meeting the Rangers were registered with the state and had support of California law enforcement.

Another quote from the article that the Colonel

made: "GALE's strategy to recruit members through veterans organizations was thwarted in 1963 when the Long Beach Press Telegram exposed his efforts to convert the American Legion Post in Signal Hill into a Ranger front. It was after this that one of the Rangers was arrested for selling a machine gun and a stem gun to undercover agents." Colonel GALE indicated that he was involved to some extent with this particular post, with this particular veterans group, that he transferred from the Hollywood post. Also, he said that the Ranger's, that particular Ranger's arrest, was an entrapment and an unfortunate error on that Ranger's part.

Another quote he made: "The CDL was quite an organization when GALE was a part of it. It grew to include the Klan, the National States' Rights Party, and many other Right Wing groups." Colonel GALE admitted connection with the Christian Defense League, indicating that he was very active.

Another quote: GALE has ample experience to found a para-military organization. In addition to more than 20 years involvement in right wing circles, GALE is a retired Lieutenant Colonel, U. S. Army. He served with the MAC ARTHUR command after World War II in the counter-insurgency staff," and it goes on. But Colonel GALE corrected this counter-insurgency information. He indicated that he was on the staff of MAC ARTHUR in Japan, but previous to

that was when he was involved in counter-insurgency and that was with the guerrilla activities in the Philippines, which was also indicated in this article.

Then, another interesting thing, he quoted: "The SAO was in large part organized by HOWARD B. GODFREY, an FBI Agent." He didn't have anything notable to say about GODFREY.

Actually, one of the things he indicated, too, in this discussion of his was that there is a lot of difficulty getting different right wing groups to cooperate in a military fashion and that that is very necessary and I get the impression that he is attempting and wishes to whip these groups into line in a really efficient military manner that will be very effective and efficient. That is the primary problem. He also indicated his willingness to cooperate with law enforcement, of course on his terms no doubt; and he said he was ready and they were ready to face those Jews and their articles and their so-called exposes and whatever else they might happen to want to do; that they are ready to communicate with their people and take care of anyone who gives them any trouble. He indicated that he had communication links all over--that from his car he could talk immediately with his link in Saugus--I don't know what link he was referring to, but it was in Saugus, and in Glendale and other areas like that, which he mentioned.

That covers much of his comments at that particular meeting. There was quite a lot of response--the people enjoyed that immensely. It was a reaction similar to a grandstanding and I think he was milking it for all he could get.

J. ANDREW SIMPSON resides at 229 Kalmia Street, San Diego, California 92101, telephone number in San Diego 232-5658.

There were some questions and answers during this session. JOE BRINKER was passing out blank pieces of paper so that people could write their comments and questions on the papers which were then passed up to Colonel GALE. Along with those blank pieces of paper, JOE BRINKER had a throw-away on the tax revolt. The heading was "Sunny San Diego Invites You to 1974's Biggest Tax Expo" and then another heading, "Tax Foes Tell Why and How They Stopped Paying Income Tax," etc., etc. It talked about meetings in the San Diego area on that. Registration forms for special get-togethers, in this case, Sheraton Inn-Airport on Friday, April 5th and Saturday, April 6th, 7 P.M. to 11 P.M. on Friday, April 5th; 9 A.M. to 5 P.M. Saturday, April 6th. For those who wish to write for information, they'd write to (for registration or information) to Tax Expo, 1570 Lily Avenue, El Cajon, California 92021. Now whether this point was being stressed more by JOE BRINKER or whether it was also under the tacit approval of Colonel GALE, I do not know.

Among the other literature and material which was picked up at that meeting, I acquired an application for the Identity seminars, "Second and Third National Identity Seminars, Manasseh Ranch, California, Ministry of Christ Church. Second Seminar dates are Saturday, the 26th of April through Tuesday, the 30th of April, 1974. Third Seminar dates are Saturday, the 29th of June through Tuesday the 2nd of July, 1974. Attendance by accepted application only--not open to the public." (They make that a stressed point in this.) "Manasseh Ranch is the national headquarters for the Identity Movement of the Ministry of Christ Church. It is located in the gold Mother Lode area of California. Altitude is nearly 3,000 feet in the high Sierra Nevada Mountains. No sleeping facilities are available so those attending should bring a motor home, camp trailer, camper truck, or travel trailer. If you do not own one, they can be rented for a nominal fee. Since bath and toilet facilities are limited, self-contained recreational vehicles are preferable. You must also bring your own food supply, except that we will have a small commissary to supplement your needs--eggs, bread, butter, potatoes, canned foods, etc. Children will be the responsibility of the parents, although it is possible to arrange for a child care period among those who attend. This can be organized after your arrival. Directions to Manasseh Ranch will be mailed to

you upon receipt of and acceptance of your application to attend. (Please cut off at perforated line and mail application to P. O. Box 423, Glendale, California 91209. Please give the information requested on the application form.)"

Underneath the application: "We wish to attend the Identity Seminar at Manasseh Ranch as indicated. Please place checkmark in the appropriate seminar space." Second Seminar or Third Seminar indicated for placement of the mark.

Following they say, "Religious services begin on Saturday, so arrivals should be prior to those dates." They ask the number of adults, number of children, ages of children, type of recreation vehicle (tent camper, truck camper, motor home, travel trailer), then they indicate here, "We hereby relieve the Ministry of Christ Church from all liability and responsibility to ourselves and all members of our family in event of accident or injury while we are on the church property at Manasseh Ranch, California. . .Name (signed); Address (printed)". . .so on. This is the form for the seminars.

MANASSEH RANCH, CALIFORNIA

MINISTRY OF CHRIST CHURCH

SECOND SEMINAR - Dates are SATURDAY, 26 April thru TUES. 30 April 1974

THIRD SEMINAR - Dates are SATURDAY 29 June thru TUES. 2 July 1974

ATTENDANCE BY ACCEPTED APPLICATION ONLY - NOT OPEN TO THE PUBLIC !

MANASSEH RANCH is the NATIONAL HEADQUARTERS for the IDENTITY movement of the MINISTRY OF CHRIST CHURCH. It is located in the gold mother-lode area of California. Altitude is near 3,000 feet in the High Sierra Nevada mountains.

No sleeping facilities are available, so those attending should bring a motor home, camp trailer, camper truck or travel trailer. If you do not own one, they can be rented for a nominal fee. Since bath and toilet facilities are limited, self-contained recreational vehicles are preferable. You must also bring your own food supply except that we will have a small commissary to supplement your needs (eggs, bread, butter, potatoes, canned foods, etc.).

Children will be the responsibility of the parents although it is possible to arrange for child care periods amongst those who attend. This can be organized after your arrival. Directions to Manasseh Ranch will be mailed to you upon receipt of and acceptance of your Application to attend.

(Please cut off at perforated line and mail application to P.O. Box 423, Glendale, California 91203). Please give the information requested on the application form)

A P P L I C A T I O N

We wish to attend the IDENTITY SEMINAR at Manasseh Ranch as indicated. (Please place check mark in the appropriate Seminar space)

() Second Seminar - Sat. 26 April thru Tues. 30 April 1974

() Third Seminar - Sat. 29 June thru Tues. 2 July 1974

Religious Services begin on Saturdays, so arrivals should be PRIOR to those dates.

Number of adults _____	Type of Recreational Vehicle:
Number of children _____	Tent camper - _____
Ages of children _____	Truck camper _____
	Motor Home _____
	Travel Trailer _____

We hereby relieve the Ministry of Christ Church from all liability and responsibility to ourselves and all members of our family in the event of accident or injury while we are on the Church property at Manasseh Ranch, California.

NAME (signed) _____

TENDS TO IDENTIFY INFORMANT

Hello Mickey,

When you come down Sat. (11:00) can you bring Sean Maguire's uniform? I keep forgetting about it and he's been waiting for it over a year now.

Chalk one up for our side. I just heard that someone blew the Zionist headquarters in New York to splinters!

I just heard some strange news. Have you heard of Paul Ruppinger? Well, he's an old guy who goes to our church, he and his wife are very right wing and he was a member of the SAC. He even came to a couple of our meetings. Another member of our church was delivering some money to the Ruppinger's home when three thugs ~~was~~ with shotguns came up and attacked them. They must

EXCISE ME

TRENDS TO IDENTIFY INFORMANT

have been tough because the young guy delivering the money is about 6'2", very husky and an ex-football player. He was beaten, Mrs Kuplinger was kicked in the face and Paul was kicked so badly he had to be hospitalized. At one point, the leader gave a hint to an accomplice with the instructions to "kill these people". Luckily the guy chickened out.

My wife got all this from our landlady who is good friends of the Kuplingers. I don't know yet the descriptions of the assailants; Walton is a close friend of Kuplinger and will get more info. There is talk that this is some kind of retaliation from the Leftists; Kuplinger's name was published in the DOOR as being an SAO member.

Rory

Date prepared

12/11/73

Date received

12/10/73

Received from (name or symbol number)

SD 2157-E

INFORMANT

Received by

SA Earl W. Peterson

Method of delivery (check appropriate boxes)

in person

by telephone

by mail

orally

recording device

written by Informant

If orally furnished and reduced to writing by Agent:

Date

Dictated

to

Transcribed

Authenticated by Informant

12/11/73

Date of Report

12/6/73

Date(s) of activity

Brief description of activity or material

Paul Ruzhynger, wife + friend
attached
Letter by Ray Wilson

File where original is located if not attached

SD 170-512A

* INDIVIDUALS DESIGNATED BY AN ASTERISK (*) ONLY ATTENDED A MEETING AND DID NOT ACTIVELY PARTICIPATE. VIOLENCE OR REVOLUTIONARY ACTIVITIES WERE NOT DISCUSSED.

Information recorded on a card index by _____ on date _____

Remarks:

- (1) SD 170-512A - ~~174~~ 174
- (1) 157-2815 (SAC)
- 1-157-3228 (Paul Ruzhynger)
- (1) 157-28 (NEWPP)
- () 157-152 (RON EDDY)
- () 157-3360 (PETER GAVIN)
- () 157-4229 (MIKE JOHNSON)
- () 157-3860 (FRANK KERR)
- () 157-3104 (CAROL KNIGHT)
- () 157-2898 (FRANK KNIGHT)
- () 157-4131 (CHARLES MARTIN)
- () 157-4223 (KILK MOORE)
- () 157-201 (GERALD SMITH)
- (1) 157-2610 (NICKY WAKEFIELD)
- () 157-3138 (VIC WALTON)
- (1) 157-2545 (RAY WILSON)
- () 157-2506 (JACK ZIMMERMAN)
- () 157-4018 (Joseph Benintende)

encl: 8
(6)

Do not disseminate fact that we have letter written by Ray Wilson as it will compromise source

Index to 157-28

SEAN MAQUIRE

157-3110*
157-28-354 p.4

Block Stamp

157-2815-412

SEARCHED	INDEXED
SERIALIZED	FILED
DEC 11 1973	
FBI - SAN DIEGO	

Report by Sandman INFORMANT

December 6, 1973

SUBJECT: Thugs attack SAO member.

As you can tell by the content of the enclosed letter, terrorist activity seems still to be going on in San Diego County. If true, what his letter says definitely refutes Paul Ruplinger's denial that he was ever a member of the Secret Army Organization.

This beating incident also seems to bear out this informant's suspicions that there is a leftist underground SAO type organization operating in the San Diego area. Perhaps these assailants who attacked the Ruplingers and their friend were the same group who shot up the mobile home park in Escondido where Mickey Wakefield resides. In any event, this latest violence is bound to heighten tensions between the warring factions.

Ray Wilson is obviously very pleased that the Zionist headquarters in New York was bombed. It was news to this informant to learn that Ray Wilson's landlady is a close friend of the Ruplingers. This means that she must be at least semi-politically aligned with the Ruplingers and possibly even Wilson himself.

That is about it for now. Hope this will help.

Sandman 12-6-73

INFORMANT

Memorandum

TO : SAC (157-2815)

FROM : SA Earl M Peterson

SUBJECT: SAO

DATE: 11/1/73

The attached article appeared in the *Rangers* magazine Vol 12 #3 October 1973,

for file.

EM:8
(1)

FILE STRIPPED

3-7-74 DMW

157-2815-411

SEARCHED	INDEXED
SERIALIZED <i>OK</i>	FILED <i>OK</i>
NOV 3 0 1973	
FBI - SAN DIEGO	



5010-108

Buy U.S. Savings Bonds Regularly on the Payroll Savings Plan

THE STRANGE TALE OF THE SECRET ARMY ORGANIZATION (USA)

San Diego is a strange town, where the niceties of Western civilization cannot hide the power of the buck and the hint of brute force. It is the city built with the largesse of twenty-five years of imperial sway: a stronghold, a haven of anticommunism, a base for racketeers. Richard Nixon considered it his lucky city. He wanted the Republican Convention to be held there, and though the city fathers and the people of San Diego were not terribly enthusiastic, the plans went forward until May 1972, when the President abruptly changed his mind.

Included in these plans, it turns out, was a tumultuous, massive, bloody riot—on such a scale as to justify the most extraordinary preventive measures, including burglary, bugging, sabotage, and perhaps even kidnapping. Watergate, we learn from the likes of John W. Dean, was simply part of a strategy to maintain domestic tranquility in the face of a serious left-wing threat.

Presumably, this Red Menace existed in San Diego as well as Miami. But San Diego has never been a radical stronghold, and while local activists did undertake extensive preparations for anti-war demonstrations during the GOP convention, the Committee to Re-elect the President seems to have had a far higher opinion of their organizing successes than they themselves dared to entertain.

Unless, of course, CREEP and its local San Diego allies were hell-bent on making certain that bedlam did in fact occur. That is precisely what a defecting *agent provocateur* named Lewis Tackwood suggested almost two years ago. Tackwood told an incredible story back in October and November 1971, one which suggested the Republicans were doing their utmost to turn San Diego into a bloodbath during the convention, with the aim of annihilating the left, smearing the Democrats, and coasting comfortably into four more years of conservative rule. His allegations were regarded as the ravings of a madman until testimony in the Senate caucus room appeared to corroborate some of his wildest stories. He told of preparations to seal off and then bomb 100,000 demonstrators attending a rock concert on Fiesta Island in Mission Bay, San Diego. All sorts of mayhem was supposed to occur. Bombs were to be smuggled into Convention Center in hollow furniture, which was al-

Richard Popkin taught philosophy at the University of California, San Diego and now teaches at Washington University, St. Louis. He is a world-renowned expert on skepticism and author of The History of Skepticism and The Second Oswald.

ready being built in Los Angeles. At least one major Republican official would perish in the melee. The Democratic Party would be tied in to the events, discredited, possibly outlawed. The Republican candidate would then win an easy victory with the overwhelming support of an outraged citizenry. Today, Tackwood sticks by his original story (to be published in September by Avon as *The Glasshouse Tapes*), though he now adds that the plan also called for blowing up the podium as President Nixon was making his acceptance speech!

[CIVIL WAR IN SAN DIEGO]

Incredible as the Tackwood scenario seemed back in 1971, it sounded less outlandish to San Diego radicals than to those on the outside. For two years, they had quite literally been engaged in protracted warfare with right-wingers determined to drive them out of the area. As early as 1970, activists associated with the San Diego *Street Journal*, an underground newspaper, were living in an armed fortress which they guarded around the clock against the attacks of night riders who would shoot into their houses, firebomb their cars and threaten their lives. (Curiously, this terror campaign intensified as the paper exposed more and more illegal activities of San Diego kingpin C. Arnholt Smith.) On one occasion, for example, sentries spotted two men crouched behind a car with a high-powered rifle trained on the house. It was late at night, but they were prepared for such emergencies. At a signal, they switched on floodlamps which bathed the house in light and they announced over a loudspeaker system that they would open fire if the men did not withdraw. The gunmen waited a moment, then dismantled their rifle, and drove off into the night.

By late 1971, the vigilantes had stepped up their attacks and had chosen their principal targets. One of these was a certain Peter Bohmer, a radical who at the time was teaching economics at San Diego State College. He began receiving threatening phone calls, and on November 13, 1971, a car parked in front of his house was firebombed. Then on December 27, 1971, a group calling itself the Secret Army Organization put out a Special Bulletin on Peter Bohmer. After listing his anti-war activities, and his background, the letter said: "For any of our readers who may care to look up this Red Scum, and say hello, here is some information

(Continued on page 56)

WANTED

for TREASON



NIXON

DESCRIPTION

FULL NAME: Richard Milhous Nixon. DATE OF BIRTH: January 9, 1913 at Yorba Linda, California. FORMER OCCUPATIONS: Used car salesman, law clerk, second rate congressman, and mediocre Vice President. PRESENT OCCUPATION: Professional liar and double crosser (part time employment as United States President). WEIGHT: 170 pounds. EYES: brown. HAIR: black. HEIGHT: 5'11". RACE: White. NATIONALITY: Claims American citizenship but actions prove this unlikely. LAST KNOWN ADDRESS: 1600 Pennsylvania Avenue, Washington, D. C. (Rumored to have a California hideout.)

CRIMINAL RECORD

RICHARD NIXON (alias Cry-Baby Nixon, alias Tricky Dicky) is an expert in disguises and has successfully passed himself off as an anti-communist in the past. He may again try using this disguise if pressed for votes in 1972. Saying one thing, then doing the opposite is Nixon's MOA. While he campaigned in 1968 on a platform of curtailing socialism he has in fact done more to establish a socialistic dictatorship than either of the last two Democrat administrations. His economic policies have continued to enrich Big Industrialists while rising prices and higher taxes have all but reduced the average worker to a state of financial slavery. This criminal has even made vicious attacks on small children (forced busing to achieve "racial balance") and has caused the destruction of local school systems. WARNING: Nixon suffers from an EMPEROR COMPLEX and becomes extremely dangerous when criticized.

CAUTION

Trickery and deceit are Nixon's trade-marks. At the present time Nixon and his chief henchman HENRY (CZAR) KISSINGER are engaged in forming an alliance with another gang of criminals, the Red Chinese. The RED CHINA GANG have slaughtered an estimated fifty million of their own people since coming to power. This Godless horde of barbarians killed thousands of Americans in the Korean War (shooting captured soldiers and starving and torturing prisoners of war). The RED CHINA GANG have been supplying the NORTH VIETNAMESE BANDITS with weapons and bullets to kill American soldiers in another no-win war in Vietnam. The very fact that Nixon is dealing with these ARCH ENEMIES OF FREEDOM is enough to convict him of treason. DO NOT LET THIS CRIMINAL STEAL YOUR FREEDOM. DEMAND HIS ARREST BY PROPER AUTHORITIES AND HIS TRIAL FOR THE CRIME OF HIGH TREASON.



Secret Army Organization



WANTED

FOR

TREASON

THIS MAN is wanted for treasonous activities against the United States:

1. Betraying the Constitution (which he swore to uphold, He is turning the sovereignty of the U. S. over to the communist controlled United Nations. He is betraying our friends Cuba, Katanga, Portugal, and befriending our enemies Russia, Yugoslavia, Poland,
2. He has been WRONG on innumerable issues affecting the security of the U. S. United Nations-Berlin wall-Missile removal-Cuba-Whore deals-Test Ban Treaty, etc.)
3. He has been lax in enforcing Communist Registration laws
4. He has given support and encouragement to the Communist inspired racial riots
5. He has illegally invaded a sovereign State with federal troops
6. He has constantly appointed Anti-Christians to Federal office. Upholds the Supreme Court in its Anti-Christian rulings
7. He has been caught in fantastic LIES to the American people including personal ones like his previous marriage and divorce

Warren Commission Exhibit 996

"Godfrey testified that he had paid the printer for the posters, picked them up, and was reimbursed by the FBI, and that the FBI understood the nature of his expenditures and saw all of his SAO publications."

SECRET ARMY

(From page 36)

[SECRET ARMY-USA]

that may help." Then his address, phone number, and car license were given, plus a physical description. "Now, in case any of you don't believe in hitting people who wear glasses, to be fair, I guess we will have to tell you he wears contact lenses."

On January 6, 1972, cross-hair stickers (the symbol of the SAO) were placed on the doors of three San Diego State College professors, including Bohmer. Then, an anonymous caller telephoned Bohmer's residence to say, "This time we left a sticker, next time we may leave a grenade. This is the SAO." Bohmer's friends were called and told to say goodbye to him. That evening, two shots were fired into Bohmer's home and a woman named Paula Tharp was wounded.

The right-wing terror campaign continued for six more months, marked by death threats, menacing phone calls, and warning messages. Its climax came on June 19, 1972, when an SAO member bombed a local porno movie house, the Guild Theatre. This last event finally aroused the San Diego police to drive the group underground.

Police action brought a halt, at least temporarily, to right-wing terrorism in San Diego. But this is not the end of the tale. For in the months that followed a very bizarre story began to unravel, one which involved the SAO, the FBI, and some mysterious contacts between the terrorists and agents of CREEP. The pieces began to appear as early as mid-1972, but it is only in recent months that they have been pulled together by reporters for another San Diego alternative newspaper, the *Door*.

The SAO, it seems, grew out of the demise of the Minutemen. According to a recently discovered document entitled "History of the Secret Army Organization," it all began one morning in February, 1970, when "... a group of six Minutemen leaders from four states met secretly in Northern Arizona to discuss the crisis that the arrest and imprisonment of two top Minutemen leaders and the assassination of a third had brought on the organization. Although some of these men had met before in their roles as Minutemen group leaders, others were meeting for the first time." These men agreed that "the Minutemen as a national coordination organization of militant right wing groups had effectively been destroyed by the pro-communist elements inside the Justice Department," and they further agreed that the need for a coordinating organization was greater than ever "in view of the increased revolutionary activity by communists in the United States." The new organization was the Secret Army Organization, and it would save America from its leftward drift under Nixon's regime.

The initial SAO documents speak of the immediate need to set up paramilitary groups to carry on guerrilla warfare, and even open and conventional warfare. A letter from "General Headquarters" dated November 8, 1971, outlines the nature of SAO operations—combat teams, organization, transportation, travel procedures, weapons and equipment, training lessons, intelligence work, security, etc. They say that the country has entered

"Stage II": a time when most people still think they can still get along with the government, but "a few real patriots are willing to take part in underground activity." Stage II "will be a time of assassination and counter-assassination, terror and counter-terror." It is a period marked by "the communist infiltration and control of the present United States government."

SAO thus set out to wage total resistance to communism, a small band determined to risk all in the struggle for America. Nationwide, the group probably numbered less than 200 members, 30 of whom were active in San Diego county. There the group was founded by two men—Jerry Lynn Davis (Southland Coordinator) and Howard Berry Godfrey (San Diego Commander and Intelligence Officer).

In late 1971 and the first half of 1972 the SAO put out bulletins on how to make booby traps, how to use ammonium nitrate in high explosives, and how to gain forced entry into buildings. (Much of this information was taken from Department of the Army Technical Manuals on "Unconventional Warfare Devices and Techniques.") The San Diego SAO also put out bulletins about local liberals, radicals and anti-war activists, all of whom were lumped together as communists. (These missives went out to a mailing list of 227 names in the area, including a naval commander, a county supervisor, a vice admiral, a Marine Corps brigadier general, a rear admiral, and some San Diego police officers.)

The group was organized into small, semi-autonomous cells. Members were listed by code numbers, and were given mail drops for their contacts.

[THE FBI CONNECTION]

SAO thrived in San Diego until the June 1972 bombing of the Guild Theatre led to the group's fall from grace. A former Birchite named William Francis Yakopec was arrested and charged with the bombing, and in September 1972, he was brought to trial in the Superior Court of the State of California in San Diego, before Judge Robert W. Conyers. Much to the astonishment of the SAO supporters, the star witness against Yakopec turned out to be San Diego Commander Godfrey. Then a local fireman, Godfrey admitted he had worked for the FBI since early 1967 as an undercover agent. He did it, he said, because "I felt it was my duty to my country." Before accepting the role, he had talked it over with J. Clifford Wallace, then the Stake President of the Mormon Church for San Diego, and more recently a federal judge by appointment of Richard Nixon. Wallace put Godfrey in touch with the FBI, and he was assigned to agent Steve Christianson, to whom he reported verbally every day. Godfrey was to work on the militant right wing, and was paid \$250.00 per month by the FBI. At first he was assigned to the Minutemen, and then with the demise of that group in San Diego, he helped start and run the SAO in November 1971. Godfrey testified that his FBI contacts knew all of his activities, including his stockpiling of illegal explosives in his house. This, he said, was done with their permission. (He later gave some of the explosives to Yakopec to "save them for after the Communist takeover of this country.")

Godfrey functioned as a one-man plumbers' operation within the SAO. He knew how to pick locks, burglarize, bomb and handle guns. The FBI paid his dues and covered his expenses. All this enabled him to carry on effectively as a terrorist. At Yakopec's trial, he said that he actively recruited for the group. What kind of people did he look for? "People with previous right wing connections." Did he enlist potentially dangerous elements? "Yes, sir."

Apparently, Godfrey himself was among the more dangerous elements in the SAO, and agent Christianson among the more dangerous eminences

of the operation. During the Yakopec trial, Godfrey admitted that he had driven the car from which another SAO member, George Hoover, had fired into Bohmer's house, wounding Paula Tharp. Subsequently, he had taken the weapon to Christianson, who had hidden it for six months. (This was evidently insufficient grounds for the FBI to take disciplinary action against agent Christianson. He continued as Godfrey's contact until the bombing of the Guild Theatre, at which point he was removed by L. Patrick Gray himself. He currently resides in Kanosh, Utah.)

In addition, Godfrey confessed to publishing a certain leaflet on February 18, 1972, the day on which President Nixon left for China. The bulletin was headlined "Wanted for Treason," and it featured a picture of Nixon and an inflammatory text which accused the President of high treason because of his China policy. The SAO symbol appeared at the bottom of the text, and the group distributed it in 15 cities—including San Diego, Phoenix, Yuma, San Francisco, and Bellingham, Washington.

At the Yakopec trial, Godfrey testified that he had paid the printer for the posters, picked them up, and was reimbursed by the FBI, and that the FBI understood the nature of his expenditures and saw all of his SAO publications. As for poor Yakopec, who had joined the SAO through Godfrey, his next door neighbor, he admitted to owning several of the posters: he said he stored them under his mattress. Why there? "I thought they were kind of corny." Later, he testified that he kept a bomb with the Nixon posters. Did he generally keep bombs under his bed? "No, I like to sleep too well." (When I visited the San Diego Court House to see the exhibit in question, the custodian located a stack of 33 posters, with the bomb casing still attached!)

It was not noted at the time, but in fact these posters bear a remarkable resemblance to leaflets which were distributed in Dallas, Texas, just one or two days prior to the assassination of President Kennedy. That poster likewise bore the headline "Wanted for Treason" and it also featured pictures (front and profile) of JFK and an inflammatory text about the President's

allegedly treasonous activities. On the hunch that the leaflet might have some connection with the assassination, the Warren Commission sent Secret Service agents to track down its author and printer. They worked from late November 1963, to May 1964, until they found that Robert G. Klause had printed the flyer and that Robert Allan Surrey, an associate of Gen. Walker, had ordered it. When Surrey testified before the Commission on June 16, 1964, he pled the Fifth Amendment on all questions concerning the leaflet. The late Hale Boggs, a member of the Warren Commission, pointed out that Surrey "is the only witness out of hundreds who has pled the Fifth Amendment." Klause denied any interest in or involvement with the contents of the leaflet, and there the matter was allowed to rest. By that point, the Warren Commission was determined to prove that Oswald had acted alone, and therefore lost interest in trying to connect the assassination with the leaflet.

Godfrey's surfacing as an FBI agent rattled the remnants of the SAO. They were angry at having been set up by the FBI, and when reporters for the *Door* began approaching their old adversaries for information earlier this year, they found that many were willing to cooperate; some were even friendly. And as the SAO began to open up, a pattern began to emerge which seemed to link the San Diego events to Watergate.

[BREAKTHROUGH]

The breakthrough came this spring when an editor of the *Door* made contact with a former SAO militant named Jerry Busch. From November 1969 to the summer of 1971, said Busch, Howard Berry Godfrey made frequent visits to the Gunsmoke Ranch in El Cajon. "It was also during June, July, and August of 1971 that Berry Godfrey and Donald Segretti (posing as 'Don Simms') visited Gunsmoke and though supposedly not 'knowing each other,' they spoke together on at least one occasion," in a quiet conversation aside. The Segretti connection is important in itself; it is particularly interesting insofar as—according to Busch's account—Segretti was in touch with SAO

while contacting his old college chums Chapin and Strachan in June 1971, but before commencing work as a dirty trickster in September 1971.

Busch did not say what Segretti discussed at the Gunsmoke Ranch, but he did report that following "these casual conversations" Godfrey came up with bizarre ideas to take care of what he called "those red punks"—in the event that the GOP held its convention in San Diego. Among Godfrey's plans in October 1971, were:

- 1) the use of massive dosages of LSD, cyanide or strychnine introduced into the punch at anti-war group meetings;
- 2) bombing of the VVAW headquarters, the Guild Theatre, and several porno shops;
- 3) bombings of the homes or offices of anti-war leaders;
- 4) kidnapping or assassination of anti-war leaders and activists;
- 5) fire bombing of vehicles and other property belonging to anti-war activists.

By November and December 1971, Busch continued, Godfrey had become more ambitious: he wanted to acquire drone planes which would carry payloads of high explosives and phosphorus to be dropped on the demonstrators. In addition, Godfrey spoke of using similar air craft, loaded with TNT or C-4 plastique, to blow up Air Force One and assassinate Nixon. The idea was to fly a bomb into the Presidential jet as it landed either at Lindbergh Field or at El Toro Marine Base. Busch claimed that he had expressed horror at the suggestion and told Godfrey he had lost his mind suggesting anything as insane as an attempt on the life of the President. Shortly thereafter, Busch and Godfrey parted ways after the former grew suspicious that he was being set up to take the rap on the shooting of Paula Tharp. By March 1972, he had left San Diego and has not yet returned.

Even before Busch left the SAO, the "Wanted for Treason" leaflet was printed and distributed. Another former SAO member corroborates that in this same period—January-February, 1972—Godfrey tried to find someone to build a plane that would carry a load of high explosives. (In addition, he was apparently trying to obtain another plane for the purpose of gassing or bombing demonstrators on

Fiesta Island.) After Busch's departure, the SAO issued its April 1972, bulletin, which began with a quote attributed to Abraham Lincoln, "A tyrant would not come to the United States from across the sea. If he comes, he'll ride down Pennsylvania Avenue from his inauguration and take up legal residence of the White House." Then followed detailed instructions on the manufacture of explosives which might be used to destroy a large bridge (Tackwood's scenario included the demolition of two bridges on and off of Fiesta Island) and on various methods of forced entry into buildings.

[A SINISTER PLOT?]

Was there a right-wing plot to kill the President? Tackwood says so. Busch says that FBI informer Berry Godfrey talked about it. The "Wanted for Treason" poster certainly indicated no loss of love between the extreme right and the President, and Godfrey was checking out the availability of drone planes.

There are other curious, if admittedly inconclusive, clues as well: The day Nixon went to China, E. Howard Hunt was working as a public relations man on a Julie Nixon Eisenhower TV spot. He raged about the China trip, "We should not send people to China, we should send bombs to China." This from a man supposedly involved in a secret scheme to re-elect the President by illegal means.

Or take this item which appeared in the March 9, 1972, issue of the *N.Y. Times* (10 days after Nixon's return from China):

WAR ALERT SENT IN HOAX BY A COAST GUARDSMAN

"New Orleans, March 8 (UPI)—An enlisted man standing watch sent a hoax message to ships at sea during President Nixon's visit to China, saying the President had been assassinated and the Vice President had declared World War III, the Coast Guard revealed yesterday.

"The authorities said that the hoax message had not been taken seriously and that the man who sent it from a small Coast Guard station in Texas had been confined and was undergoing medical evaluation.

"The message was sent February 27 by teletype to 22 ships in the Gulf of

Mexico."

There was no further story on this that I have been able to find. If the hoax message had gone out to a Polaris submarine, Hunt might have gotten his wish, that bombs would be sent to China.

Then, the *L.A. Times* reported on July 13, 1973 that a former Minuteman had requested political asylum in Fiji, saying he had secret information on Watergate and feared assassination.

All of this proves nothing, of course, but it suggests that the Dirty Tricks operation may have been much more complex than we have been led to believe. Perhaps there was a plot to kill Nixon, and then again Godfrey's plot may have been a further hoax aimed at discrediting the left and the Democratic Party. What did Segretti discuss with Godfrey, and why and how did he meet Godfrey in the first place? How did it happen that the FBI financed a threat on the life of a President (a crime which carries a penalty of up to five years in jail and a \$1,000 fine)? In the past, the Secret Service has taken such threats very seriously. A check of the *New York Times* index shows that at least 11 people were arrested between January, 1972 and May 1973 for doing much less than Godfrey. Most seem to have been psychopaths or drunks, with no positive plan—just verbal threats.

But then there are other instances: Arthur Bremer's Ottawa visit on April 13-14, 1972, for example, when he supposedly stalked Nixon. On May 30, three bombs demolished the tomb of the father of the Shah of Iran an hour before Nixon was scheduled to lay a wreath there. On August 11, a certain A. B. Topping was arrested in New York after paying an undercover agent \$1,000 to kill Nixon. Topping, it developed, was well-to-do, of the American Nazi political persuasion, and interested in having the President killed the week after the pay-off. No trial has been held. And then in late May 1973, one of Nixon's helicopters went down in the Bahamas. It subsequently came out that the President has three helicopters ready at all times and chooses which to use one minute before the flight.

Watergate has uncovered an administration racked by factionalism. Under Hoover, the FBI was at odds with the White House—to such a

degree that Hoover was willing to use secret documents to blackmail the President. In addition, Nixon was having his difficulties with the leaders of the CIA, and James McCord wrote to John Caulfield at Christmas, 1972, that if Nixon pushed out Helms and involved the CIA in Watergate, "every tree in the forest will fall." Could there have been other tensions as well? Were there elements which opposed Nixon for his policy of rapprochement with China and Russia, and which would have preferred, say, Spiro Agnew as President?

After returning from San Diego in July 1972, acting FBI director, L. Patrick Gray, talked to Nixon and said: "Mr. President, there is something I want to speak to you about. Dick Walters and I feel that people on your staff are trying to mortally wound you by using the CIA and the FBI ..." His words may have carried greater import than any of us have heretofore suspected.

* * *

In August of this year, Godfrey reportedly admitted to the San Diego Door that there was a real plot to kill Nixon. He blames the plan on his erstwhile cohort, Gary Lynn Davis. ■

(Mount Clipping in Space Below)

Court Reverses Conviction

The Fourth District Court of Appeal has handed down a decision reversing the conviction of George Mitchell Hoover, 36, a key figure in the series of trials here involving alleged members of the right-wing paramilitary Secret Army Organization.

Hoover, formerly of Santee, was sentenced to from five years to life in state prison last January, following his conviction in Superior Court on charges of assault with a deadly weapon, firing into an occupied dwelling and possession of a billy club.

The appeal court's decision sends the case back to Superior Court here, where a jury will weigh the question of whether the key prosecution witness was working as a "double agent," according to Richard Tyree, one of the attorneys involved in the

appeal, filed through Appellate Defenders, Inc.

The key prosecution witness was Howard Barry Godfrey, a former San Diego city fireman who was a paid FBI informant, assigned to infiltrate extremist right-wing groups.

Tyree said the main point emphasized in the appeal of Hoover's conviction is whether the jury should have been allowed to determine Godfrey's credibility, and if he was working as a "double agent" in concert with both the FBI and SAO, finally deciding to testify for the state to protect himself.

Superior Court Judge William T. Low, at the time of Hoover's trial, had ruled there was insufficient evidence to submit this question to the jury, Tyree said.

The charges against Hoover stemmed from the firing

of a bullet into the home of Peter Bohmer, then a former assistant professor at San Diego State University, on Jan. 6, 1972. The bullet struck a friend of Bohmer's, Paula Tharp, 23. Bohmer resided at 5155 Muir Ave., Ocean Beach, at the time.

Godfrey testified during the SAO trials here that Hoover shot into the Bohmer home. He said he was in

Hoover's car at the time. Justice Vincent A. Whelan of the Appeal Court said in a 16-page opinion that it was an error to refuse to give instructions to the jury to decide if Godfrey was an accomplice. Whelan said fur-

ther that if a third person had seen the incident and called police, there would have been a strong possibility that Godfrey also would have been prosecuted if the car had been stopped.

(Indicate page, name of newspaper, city and state.)

Page B-2

SAN DIEGO UNION
San Diego,
California

Date: 10/31/73
Edition: Home Edition
Author:
Editor: Gene Gregston
Title: SECRET ARMY ORGANIZATION

Character:
or
Classification: 157 - 2815
Submitting Office: San Diego
 Being Investigated

410

[Handwritten signature]

[Handwritten signature]

UNITED STATES GOVERNMENT

Memorandum

TO : SAC (157-2815) (P)

DATE: 9/27/73

FROM : SA EARL M. PETERSEN

SUBJECT: SECRET ARMY ORGANIZATION
EM

The following individuals have been contacted to determine whether any SAO activity exists in San Diego at this time:

Les Oberlies, Detective Investigative Support Unit,
San Diego Police Department 9/27/73.

SD 2420-PEI 9/27/73.
SD 2157-E 9/6/73.
SD 2448-PEI 9/27/73.

INFORMANTS

Howard Barry Godfrey, telephonic 9/18/73.

All of the above stated that there is no known SAO activity in San Diego at this time and that there has been none since the trials of members were completed.

LEAD:

Will expedite submission of LHM reflecting that SAO is dead and closing of this case.

EMP:emp
(2)

157-2815 - 404

SEARCHED	INDEXED
SERIALIZED	FILED
SEP 27 1973	
FBI - SAN DIEGO	

Peteresen



Buy U.S. Savings Bonds Regularly on the Payroll Savings Plan

(Mount Clipping in Space Below)

Appeal Filed In Conviction Of Secret Army Key Figure

An appeal has been filed with the witness stand when he de-
the Fourth District Appellate nial bombing the theater.
court, challenging the 1972 con- Fred Hetter, Yakopec's attor-
viction of William Francis Yak- ney, said he has appealed his
ec, a key figure in the Secret client's conviction on grounds
Army Organization trials. of errors in trial and in pretrial
Yakopec. 31, was sentenced motions.

On Oct. 24, 1972, to one year to Hetter said he was wrongful-
ly in state prison after his Oct. ly denied the right to suppress
conviction on charges of as- evidence on the basis that he
ault with intent to commit was not allowed to question un-
murder, assault with a deadly dercover policeman Rubien
weapon on a police officer, Brandon on affidavits in sup-
simple assault and possession port of a search warrant for
f. explosives. Yakopec's El Cajon residence.

The charges stemmed from Further, Hetter said, he was
an investigation of activities al- not allowed to question Bran-
legedly linked to the right-wing don on the reliability of the key
paramilitary Secret Army Or- prosecution witness, Howard
ganization, including the June Barry Godfrey, a former San
19. 1972 bombing of the Guild Diego city fireman who was a
Theater, an adult movie house, paid FBI informant assigned to
that showed sex-oriented films. infiltrate extremist right-wing
No one was injured. groups.

Yakopec, just before his sen- Hetter said Godfrey's rela-
tencing, made a dramatic con- bility as a witness was open to
fession, saying he had lied on question because he had partic-

ipated in four felonies, in-
volving the setting off of an in-
cendiary device in his yard,
and possession and sale of ille-
gal explosives.

He said further that he had
requested instructions from Su-
perior Court Judge Robert W.
Conyers, the trial judge, on en-
trapment, but his request was
denied. Hetter added that
Yakopec's case was one of en-
trapment.

On Yakopec's confession be-
fore sentencing, Hetter com-
mented that it would be diffi-
cult to go to trial on the basis of
a confession, and, if a new trial
does develop, the defense would
concentrate on the question of
entrapment.

Yakopec was one of several
persons indicted by the county
grand jury in its investigation
of Secret Army Organization
activities. The series of trials
that resulted captured wide
public attention.

(Indicate page, name of newspaper, city and state.)

San Diego Union
9/26/73

Date:
Edition:
Author:
Editor:
Title:

Character:
or
Classification:
Submitting Office:

Being Investigated
157-2815

SEARCHED INDEXED
SERIALIZED FILED
SEP 26 1973
FBI - SAN DIEGO

Henry cross
made for
157-2815 (SAA)
170-286 (Hoffberg)
EM 8

(Mount Clipping in Space Below)

FBI FUNDS SECRET ARMY ORGANIZATION

SAN DIEGO (LNS) -- A leader of a right-wing paramilitary group responsible for several armed attacks on radicals here over the last year has stated that the group was partly organized and funded by an informer for the Federal Bureau of Investigation.

According to Jerry Lynn Davis, the former Southern California coordinator for the wellarmed Secret Army Organization (SAO), FBI informer Howard Berry Godfrey participated in a shooting and several fire bombings and burglaries, while receiving regular payments from the FBI.

According to Davis' account, the SAO was formed in 1971 to organize a "resistance movement", should the U.S. be conquered by a foreign power. Godfrey, the FBI informer, was one of the six founding members and contributed money used to print the group's recruiting literature. Davis also explained that Godfrey consistently took a "more militant line" than most of the members.

In court testimony, Godfrey admitted that he was riding in a car on January 6, 1972 when another SAO member fired a shot into a house occupied by radical organizing demonstrators for the Republican Convention which was originally scheduled to take place in San Diego. The bullet shattered the elbow of Paula Tharp.

Godfrey's role was first revealed, in part, last June when a member of the SAO was arrested for blowing up a theater that showed porno films. It was at this time that the San Diego police reportedly learned that the FBI had an informer in the SAO.

On the stand Godfrey admitted that he had supplied the explosives used in the bombing.

(Indicate page, name of newspaper, city and state.)

17 "THE EUGENE AUGER"
EUGENE, OREGON

Date: 8/24/73
Edition:
Author:
Editor:
Title: "THE EUGENE AUGER"
NEW LEFT MOVEMENT - PUBLICATION
Character: IS - REVACT
or
Classification:
Submitting Office: PORTLAND
 Being Investigated

*Serialized 6 clark
make copy
for 157-3001
EJ*

157-2815-402
SEARCHED INDEXED
SERIALIZED FILED
SEP 3 1973
FBI SAN DIEGO
Peterman

Of Godfrey's contribution to the SAO in time and money, Davis said, "you might say that the SAO was federally funded anti-poverty program for the right wing." Davis a 31 year old construction worker, told his story to a reporter after being released from jail where he was being held awaiting sentencing on a charge of possession of explosives.

According to The Door, Segretti came to San Diego in March 1972 and talked to a 30 year old student at San Diego State College, Ron Johnson. Johnson was asked to help out in preparation for the convention. He was asked if he had any longhaired friends who weren't doing anything. Specifically he was asked what he knew about radical professor Peter Bohmer and activist Paula Tharp.

"One thing Segretti said that stood out in my mind. He told me that if I located any trouble makers as the GOP convention approached, they could be gotten rid of. I asked him what he meant and he said, "they could be sent out of town for a limited time, Johnson told The Door."

UNITED STATES GOVERNMENT

Memorandum

TO : SAC, SAN DIEGO

DATE: August 29, 1973

FROM : SAC, BALTIMORE (157-NEW) (P)

SUBJECT: S.A.O.
EM - MM
OO:SD

Re WFO letter to the Bureau, 7/5/73.

In referenced communication, WFO advised that on 6/13/73, WF 2133-C obtained from Mrs. RAFAELA STEPHENS, widow of JESSE CLAYBURN STEPHENS, self-styled East Coast coordinator from Minutemen Organization, a copy of the name card file. This file was identified by Mrs. STEPHENS as a "Minutemen Registration" file, according to the informant.

WFO has concluded, after a review of the above file, that it contains the names of STEPHENS' Minutemen group together with his mailing list, contributors, and right wing contacts.

The name card file listed the following identifying data regarding the subject:

P.O. Box 5791
San Diego, California 92105.

Investigation in this case is predicated upon the fact that subject's name was listed among well-known white extremists and is designed to conduct preliminary inquiries to identify subject and to contact sources to determine if subject is presently involved in white hate activities.

Baltimore indices regarding captioned subject negative.

San Diego need not furnish Baltimore results of investigation unless pertinent to this Division.

② - San Diego (REGISTERED MAIL)

2 - Baltimore

RCG:rk

(4)

157-2815-401

SEARCHED	INDEXED
SERIALIZED	FILED
SEP 1 1973	
FBI - SAN DIEGO	

Peterson



FBI

Date: 8/6/73

Transmit the following in _____
(Type in plaintext or code)

Via AIRTEL AIR MAIL - REGISTERED
(Priority)

TO: SAC, SAN DIEGO (157-2815)
FROM: SAC, LOS ANGELES (157-7318) (RUC)
SUBJECT: SECRET ARMY ORGANIZATION (SAO)
EM
OO: San Diego

Re San Diego airtel to Los Angeles dated 6/27/73.

The following confidential informants and sources have advised that there is no SAO in the Los Angeles area:

CSLA 5114-E	CSLA 4703-S
CSLA 5313-E	CSLA 5314-E
LA 6993-E	LA 7000-E (PROB)

INFORMANTS

San Diego's attention is also directed to Los Angeles letter and letterhead memorandum to the Bureau dated 8/16/72, wherein it was pointed out there was no SAO in the Los Angeles area.

② - San Diego (AM-RM)
1 - Los Angeles

LWS/cer
(3)

157-2815-400

SEARCHED	INDEXED
SERIALIZED	FILED
AUG 9 1973	
FBI - SAN DIEGO	

P. L. ...

Approved: _____ Sent _____ M Per _____
Special Agent in Charge

Date processed
12/4/72

Date received
12/1/72

Received from (name or symbol number)
CSLA 5114-E

Received by
SA LEROY W. SHEETS

Method of delivery (check appropriate blocks)
 in person by telephone by mail orally recording device written by Informant

If orally furnished and reduced to writing by Agent:
Date _____
Dictated _____ to _____
Transcribed _____
Authenticated by Informant _____

Date of Report
11/27/72

Date(s) of activity
11/21/72

Brief description of activity or material
Info re meeting of Citizens Council
of Los Angeles held 11/21/72 at
Olympian Motel, Los Angeles.

File where original is located if not attached
170-538A-2204

* INDIVIDUALS DESIGNATED BY AN ASTERISK (*) ONLY ATTENDED A MEETING AND DID NOT ACTIVELY PARTICIPATE. VIOLENCE OR REVOLUTIONARY ACTIVITIES WERE NOT DISCUSSED.
 Information recorded on a card index by _____ on date _____

Remarks:

CC: 157-875 (JULIE HANNA)

157-5068 (MINUTEMAN)
10-074834 (DICK ROGERS)

157-2815-399

~~157-1798~~

- INDEX
- CITIZENS COUNCIL OF L.A.
- CALVIN FOX
- ROD DUFF
- BOB LYONS
- BERRY GODFREY
- SECRET ARMY ORG.
- McINTYRE
- MR. PITTMAN
- VA KOPIC
- TROY HAUGHTEN
- TACKWOOD

*Article -
Make copies for
SD 157 - (Calvin box)
SD 157-2815 (SAC)*

SEARCHED _____ INDEXED _____
SERIALIZED _____ FILED _____
DEC 11 1972
FBI - LOS ANGELES

J.P. Petersen

157-5068-83

LWS/DMB
(3) OMB

Read by *[Signature]*

SEARCHED _____ INDEXED _____
SERIALIZED _____ FILED _____
DEC 1972
FBI - LOS ANGELES

SOURCE:

S-210

DATE & TIME:

November 21, 1972 2000 hours.

LOCATION:

Olympian Motel
Los Angeles

SPONSOR:

Citizens Council of Los Angeles

PURPOSE:

Meeting to discuss the pending Perjury trial of Calvin Fox on 12-5-72 and Police Informants and FBI finks.

PERSONS IDENTIFIED:

Rod Duff - MC
Calvin H. Fox - Speaker
Julie Hanna - Gale's Church
Bob Lyons - attending Gale's Church in Glendale regularly.

Calvin Fox runs a Gulf Service Station in ElCajon.

Fox stated that he was approached many times by Berry Godfrey who said he was Lt. Commander in the Secret Army Organization. He tried to sell Fox illegal weapons, etc. and invited him to join the S.A.O.

Berry Godfrey was a paid agent for the FBI for at least 5 years and was assigned to investigate Right-Wing Organizations.

Fox said that Godfrey hung around his station alot but that he did not join as he was doubtful of the organization.

In May, Fox went to Washington to march with McIntyre in the May 20th. protest, "To Win the War".

While he was away, FBI agents through an informer, Mr. Pittman working for Fox, went through various files without permission. Upon his return from Washington, Fox tried to discover why all the interest from the FBI. After many phone calls and many days he was told that since he was a former member of the Minutemen, involved with the S.A.O, a known Wallace supporter, since Wallace was shot and Mr. Fox was not far from the area, that he was suspect and they were trying to get his license number to give to the Secret Service.

When Yakopic supposedly bombed the "sex theatre" he was again converged on by the FBI. Godfrey told them he was a member of the S.A.O. and the FBI had a copy of an application that he was to have filled out.

CONFIDENTIAL

He was a character witness for Yakopic but because of some "planted" evidence he will be tried for perjury.

During this time (right after the theatre bombing) Fox stated the FBI went to Troy Haughten's mothers home in LaMesa and did some extensive digging in the backyard and found nothing, they then left with no explanation.

Fox also made the comment that Tackwood, Los Angeles Police Dept. Undercover Agent, quit recently and stated he did so because, "I don't want to plant bombs and kill delegates to the convention to be held in San Diego". Tackwood has written a book called, "Glass House", soon to be released, it deals with that aspect of his life.

Fox feels the FBI and Godfrey are recruiting and pushing to involve right-wingers in illegal operations; along with the police department (bombing and laying the blame on the right-wing), were setting the stage for a riot so Marshall Law could be called and U.N. troops be called in.

In conclusion:

There were no real points made, or a moral or even much of a discussion dealing with ways to keep out infiltrators. They made a pitch for funds to help Fox pay for his Perjury trial (\$5,000.00).

Those in attendance seemed to enjoy the talk but nothing constructive came out of the meeting.

I also sensed that Rod Duff is trying to pull himself out of a slump or depression. When mentioning it to Julie Hanna, she agreed saying that her friend Lick Rogers has also stated same (he is a member).

He fell short as a leader in my opinion, as he asked the group what they would like to do and what type of meetings they wanted - he should have told them what he had going and got the people busy and active right then.

I asked him, after the meeting, what the dues were and did he do for the council or did the council do for him and the movement - he looked startled and replied, "I'm afraid right now I do for the council". - looks to me like he needs the up and coming seminar to put him back on his feet.

One other note - Fox feels like Yakopic was paid off as his wife seems to have alot of money and a brand new car.

END OF REPORT

11-27-72

UNITED STATES GOVERNMENT

Memorandum

TO : SAC, SAN DIEGO (157-2815) (P)

DATE: 7/17/73

FROM : SA DWIGHT G. GARRETSON

SUBJECT: SECRET ARMY ORGANIZATION
(SAO)
EM
(OO: San Diego)

Re Memo of SAC REX I. SHRODER dated 7/6/73.

On 7/12/73, Mr. GREGORY MARSHALL, also known as EDWARD GUILBERT, 1612 Harbison Canyon Road, El Cajon, California, telephone number 445-2984, was interviewed at the San Diego Office of the Federal Bureau of Investigation.

MARSHALL advised that he does not have any specific information regarding the Secret Army Organization and is acquainted with only one person affiliated with the Secret Army Organization, that being RICHARD FLEURY, who is his next-door neighbor. He stated that the reason he had contacted the FBI was that on 6/1/72, his home had been burglarized and he had the following items stolen from him:

1. M-1 Rifle
2. NATO 762 Assault Rifle
3. Model 70 Shot Gun
4. M-3 Sniper Scope

MARSHALL also advised that on the day of the burglary, RICHARD FLEURY and another neighbor named EDWARD BEGLEY had come to his home, and in conversations with them after he had discovered the burglary, he had been

- 5-San Diego
- (2-157-2815)
- (1-157-3290) (RICHARD FLEURY)
- (1-157-3289) (GENEVIEVE FLEURY)
- (1-157-3001) (JERRY LYNN DAVIS)

DGG:vkw
(5)

157-2815-393

SEARCHED	INDEXED
SERIALIZED	FILED
JUL 18 1973	
FBI-SAN DIEGO	



SD 157-2815

informed by them that they had discovered his gate open and his front door unlocked during the day time hours on June 1/, 1972. He further advised that in one of the Secret Army Organization trials, HOWARD BARRY GODFREY had testified that JERRY LYNN DAVIS had known about the weapons stolen from MARSHALL. MARSHALL could not recall whether GODFREY had testified that he had actually at the time seen these weapons or had testified that he had merely been informed of these weapons by DAVIS.

MARSHALL stated that he desired to know whether or not the FBI had any information regarding his weapons and his primary interest was to recover his weapons.

MARSHALL was advised that all information furnished by HOWARD BARRY GODFREY to the FBI regarding violations of local or state statutes had been disseminated to the appropriate local or state agency, and that he should contact the San Diego County Sheriff's Office as that agency would have jurisdiction over the burglary which occurred at his residence. He said he had been in contact with the San Diego County Sheriff's Office, and had been advised that his weapons had not been recovered and that the Sheriff's Office had no information regarding the whereabouts of these weapons.

MARSHALL further advised that he is aware of the location of the Gunsmoke Ranch, but does not frequent this location, and again advised that he has never met any of the persons affiliated with the Secret Army Organization except RICHARD FLEURY. He further advised that FLEURY has a considerable number of weapons at his residence, including shot guns, rifles, and automatic pistols. He has made statements to the effect that he will not again be taken alive. MARSHALL expressed his personal point that FLEURY is mentally unbalanced, and further advised that FLEURY is highly critical of all law enforcement in general, and of the FBI, in particular. He said FLEURY plans to file suit

SD 15/-2815

against the San Diego, California, Police Department or the San Diego County Sheriff's Office for the return of weapons which were seized from him at the time of his arrest. He said that FLEURY also talks about going to South America and is highly critical of the United States Government in his conversations. MARSHALL further advised that GENEVIEVE FLEURY in conversation with other neighbors which have been related to MARSHALL, has indicated that she thinks her husband, RICHARD FLEURY, is planning to do something "out of the ordinary". MARSHALL said he did not know what she meant by out of the ordinary, and further advised that he has had no direct conversation with her, but has been hearing these rumors from other people, and he expressed the opinion that FLEURY's departure from the United States may be what these rumors refer to. He said that GENEVIEVE FLEURY has indicated to neighbors that RICHARD FLEURY thinks that she will accompany him to South America, but, in fact, she does not plan to go with him if he does leave this country.

MARSHALL advised that he is not on friendly terms with FLEURY, in that he somewhat suspects FLEURY of burglarizing his home, and he feels that FLEURY does not trust him. He said he would relay any information regarding FLEURY's activities to this office, but said that because of his relationship with FLEURY, he would not be in a position to actively seek information regarding FLEURY's plans.

UNITED STATES GOVERNMENT

Memorandum

TO : SAC, SAN DIEGO (157-2815)

DATE: 7/13/73

FROM : SA DWIGHT G. GARRETSON

SUBJECT: SECRET ARMY ORGANIZATION
EM

Review of pertinent files reveals the following information:

Information regarding shooting of PAULA THARP by GEORGE MITCHELL HOOVER was originally furnished to SA STEVEN LEE CHRISTENSEN by HOWARD BARRY GODFREY on 1/12/72. The shooting had occurred on 1/6/72. See memo of SA CHRISTENSEN dated 1/13/72 and San Diego Nitel to Bureau 1/13/73 (170-286-90 and 157-3017-20).

The information regarding this shooting was furnished to CAPTAIN KENNETH O'BRIEN, SDPD by SAs CHRISTENSEN and EARL M. PETERSEN on 1/13/73. See San Diego Nitel to Bureau 1/14/73 (170-286-88 and 157-3017-19).

2 - 157-2815

1 - 157-3017

1 - 170-286

(4)

DGG:

157-2815-391

SEARCHED	INDEXED
SERIALIZED	FILED
JUL 19 1973	
FBI-SAN DIEGO	

10/8

UNITED STATES GOVERNMENT

Memorandum

TO : FILE (157-2815)

DATE:

FROM : SAC REX I. SHRODER

SUBJECT: GREGORY MARSHALL
SECRET ARMY ORGANIZATION

Captioned individual who resides at 1612 Harbison Canyon, telephone number 445-2984, called today and indicated he would like to speak to an agent knowledgeable in the SAO organization.

He said that he resides near where some SAO members live and that his residence was burglarized some time ago and some weapons were stolen. He is primarily interested in furnishing information which may be of interest concerning the SAO and the disposition of some of the stolen weapons.

I told him that we would have an agent contact him on Monday, July 9, 1973, and arrange a convenient time for subsequent interview.

San Diego indices show a GREG MARSHALL - 157-3290-3.

RIS:mah
(2)

Maloney A.
Rowley P.

Lanston advised. RJ

Contacted 7/9/73 & mt. set for 7/12/73

157-2815-390

SEARCHED	INDEXED
SERIALIZED	FILED
JUL 6 1973	
FBI - SAN DIEGO	

Lanston A.



SAC, SAN DIEGO (157-1816) (P)

4/4/73

SA DWIGHT G. GARRETSON

JAMES EVAN FOTO
EM - SAO
(OO: San Diego)

Attached to each copy of this memo is a copy of an FD-302 containing results of interview of subject. This FD-302 is being disseminated to the indicated files because subject furnished information regarding the subjects of these files.

- 2 - 157-1816
- 1 - 157-3001 (DAVIS)
- 1 - 157-3388 (BOYLE)
- 1 - 157-1614 (TROY HAUGHTON)
- ① - 157-2815 (SAO)
- 1 - 157-1798 (Minutemen)

DGG:blb *blb*
(7)

157-2815-376

SEARCHED _____	INDEXED _____
SERIALIZED _____	FILED _____
APR 6 1973	
FBI - SAN DIEGO	

162

FEDERAL BUREAU OF INVESTIGATION

Date of transcription April 3, 1973

JAMES EVAN POTO, 3495 Olga Street, San Diego, California, was interviewed at the San Diego Office of the Federal Bureau of Investigation. He was informed of the jurisdiction of the FBI in the field of Internal Security.

POTO advised that he had formerly been associated with both the Minutemen Organization and the Secret Army Organization. He explained that approximately eight or nine years ago he had become acquainted with JERRY LYNN DAVIS who was known to him as SAM DAVIS. He said he had met DAVIS at various gun shops and swap meets in the San Diego area, explaining that both he and DAVIS had been interested in firearms. He also advised that at about that same time he had purchased a home in La Mesa, California, through VAHL BOYLE who worked as a Realtor in that area. Through her he had met her son TROY HAUGHTON, who was also acquainted with SAM DAVIS. He continued that through DAVIS and HAUGHTON he had become interested in the Minutemen Organization and had participated in activities of this organization including literature distribution and marches and demonstrations against "Leftist" groups and individuals.

POTO stated that he had never actually been a member of the Minutemen Organization but admitted that he might have submitted an application for membership and stated that he did not recall specifically whether or not he had applied for membership and whether or not he had been accepted as a member.

POTO continued that during the later part of 1967 he had moved from the San Diego area to Phoenix, Arizona, and through the Minutemen Organization in San Diego had been placed in contact with one EV MOORE described as a Minuteman Leader in Phoenix. He said he had met MOORE but had not participated in any Minutemen functions in Phoenix.

POTO advised that he had been acquainted with TROY HAUGHTON and said he had no information regarding the disappearance of HAUGHTON. He related that he had heard rumors that HAUGHTON had been killed by ROBERT DE PUGH. He did not know the original source of any of these rumors but said that they were related to him by JERRY LYNN DAVIS,

Interviewed on 3/29/73 at San Diego, California File # SD 157-1816
by SA JOHN O. TRETHEWEY, JR.
SA DWIGHT G. GARRETSON/blb Date dictated 4/3/73

and to his knowledge these rumors were based on conjecture with no basis in fact. He reiterated that he had no first hand knowledge of what happened to TROY HAUGHTON.

POTO continued that he had returned to the San Diego area sometime during the fall of 1970, and upon his return to San Diego had renewed his acquaintanceship with JERRY LYNN DAVIS. He said that sometime over a year ago, exact date not recalled, he had been invited by DAVIS to join a new organization being formed by DAVIS by the name of Secret Army Organization, which DAVIS said was to be the "Refined Version of the Minutemen." POTO stated that he had declined this invitation to join because he did not have time to participate in any such activities because of his business.

POTO advised that he had met BARRY GODFREY on three or four occasions at DAVIS' home and had also met MICKEY HOOVER during target practice sessions which he had had with DAVIS. He said he was not acquainted with FRANK YAKOPEC or with any other individual known to or rumored to be affiliated with the Secret Army Organization.

POTO described himself as a right wing conservative as far as politics were concerned and stated he is opposed to the use of firearms in any form, and for this reason did not condone the activities of the Secret Army Organization.

POTO said he had no information regarding illegal weapons or explosives in the possession of any of his associates, except that he had seen a small amount of fuse at DAVIS' home.

POTO further advised that over the period of the past nine years, he had contributed money only to the Minutemen Organization, to TROY HAUGHTON, and also to JERRY LYNN DAVIS. He said he did not give any money to the Secret Army Organization but had given money to DAVIS to assist in DAVIS' defense after DAVIS had been arrested. POTO related when he had been affiliated with the Minutemen Organization, all communications and correspondence to him from the Minutemen had originated in San Diego. He assumed that it had been mailed by TROY HAUGHTON. He said he had never had any contact with the National Headquarters or the National Leaders of the Minutemen.

³
SD 157-1816

POTO commented that he occasionally carries a revolver and gave the reason as for protection because he often carries large sums of money in connection with his employment.

POTO provided the following description of himself:

Race	White
Sex	Male
Date of Birth	September 6, 1941
Place of Birth	Hammond, Indiana
Height	5' 10"
Weight	180
Hair	Brown
Eyes	Hazel
Arrest Record	Wears Glasses
Social Security Account Number	None
Employment	JFK Act 6 (3) Manager Neubens Restaurant Grossmont Shopping Center La Mesa, California
Military Service	None
Marital Status	Divorced from PAMELA SHELDON, who has since remarried and now resides in Kansas City, Kansas.
Education	Attended Indiana University and San Diego State College but received no degree from either institution.
Parents	EUGENE and RUTH POTO Exact address unrecalled Echo Court La Mesa, California
Former Residence	Royal Palm Road Phoenix, Arizona 1967 - 1970
Telephone Number	292-0176

February 5, 1973

Honorable Louis L. Hicks
Apartment 221
8401 North New Braunfels
San Antonio, Texas 78209

Dear Judge Hicks:

I have received your letter of January 26th, with enclosures, and appreciate your bringing this information to my attention. I am pleased to enclose a copy of my remarks of January 25th before the National Conference on Criminal Justice in Washington, D. C.

Sincerely yours

L. Patrick Gray, III

L. Patrick Gray, III
Acting Director

Enclosure

- ① - San Diego - Enclosures (3)
- 1 - San Antonio - Enclosures (3)

157-2815-357

SEARCHED	INDEXED
SERIALIZED	FILED

FBI - San Antonio

[Signature]

Maloney A
Petersen G

LOUIS L. HICKS
2401 NORTH NEW BRUNSWICK
SAN ANTONIO, TEXAS 78206
APT. 221

Jan. 26 1973

Mr. Patrick Gray III
Federal Bureau of Inv.
Department of Justice
Washington D.C. 20535

Dear Director;-

I have just heard the very sensible and well timed remarks of your brief appearance on Channel 13 this morning (T.V.). Your predecessor used to send me some of his speeches. If you have a copy available I would like to read the complete statement.

Incidentally I have asked my "Washington Observer" friends in California to lay off the F.B.I. (Howard Godfrey) and get rid of some of their quack economists.

I have also advised them that I am not in sympathy with their "Tax Strike". Every American should obey the law whether he likes it or not, and I do not belong to the John Birch Society.

I enclose the front page of Jan. 1 1973 issue. (Xerox) because I understand every Senator and Congressman gets a copy.

Yours for confirmation,
(Judge) Louis L. Hicks.

Louis L. Hicks

157-2815-356

SEARCHED	INDEXED
SERIALIZED	FILED
FEB. 7 1973	
FBI - SAN DIEGO	

Petersen

WASHINGTON OBSERVER

NEWSLETTER

What country can preserve its liberties, if its rulers are not warned from time to time that the people preserve the spirit of resistance?" —THOMAS JEFFERSON

NUMBER 151

JANUARY 1, 1973

LYNCH

PART II

Evidence is accumulating that if you are Jewish or Negro, you can break the law with impunity, but if you are White and a patriot, you are a second-class citizen. There is a growing double standard of justice in the U.S.—harsh punishment for patriots (secured by the perjury of federal agents) and leniency for the Left.

Last month saw two outrageous miscarriages of justice in San Diego. On December 21, ten tax protestors were declared "guilty" of "conspiracy to rescue seized property" by a jury which followed the promptings of a federal judge.

Judge Leland C. Nielsen clearly had received orders from higher-ups to convict the ten defendants, no matter what he had to do. He showed open contempt for the rights of the accused, refusing even to recognize that the Heck Warehouse—the focus of the picketing that led federal agents to physically assault the patriots and arrest them on trumped-up charges—had not even been legally seized by the IRS until the day after the arrest of the defendants!

The federal agents involved perjured themselves on the witness stand but the jury (composed in large part of bureaucrats and others whose salaries are paid for by taxes) refused to believe that FBI and Treasury agents would act in the criminal manner they did and then lie under oath.

Although prosecution testimony was inconsistent, distorted and contradictory, Nielson brazenly dismissed defense motions and objections and upheld the prosecution throughout.

The other lynching bee in San Diego concerned two men who were admittedly entrapped by undercover FBI agent-provocateur Howard Godfrey.

Undisputed are the facts that Godfrey incited William F. Yakopec into bombing a porno movie house, and even supplied the dynamite.

Yakopec was convicted of the bombing on Godfrey's testimony. A witness for Yakopec, Calvin H. Fox, was subsequently convicted of perjury on Godfrey's testimony, although the evidence clearly indicated that Fox was telling the truth

Contributions for the "San Diego Ten" appeal may be sent to *The Educator*, Box 333, Fullerton, Calif. Send contributions for Fox's appeal to L.A. Citizens Council, Box 1-16, Arcadia, Ca. 91006.

1972

REVIEW

In retrospect 1972 was a precedent-shattering year in America's international relations. President Nixon abruptly reversed his previous anti-Communist stance. The machinations of his foreign policy mentor, Dr. Henry A. Kissinger, resulted in a detente with Peking and Moscow, which was enthusiastically supported by the "liberal" news media and paved the way for Nixon's highly publicized trips to Red China and Soviet Russia. The general public, bemused and confused by an avalanche of promotional publicity featuring world peace as the ultimate goal, was cajoled into accepting the bland assurances of the Kissinger-Nixon team. WO readers had been forewarned about the Nixon-Kissinger scheme of Soviet-American convergence as the first step in the Grand Design of One World Government.

In reviewing the many exclusive news items of WASHINGTON OBSERVER in the course of 1972 it will be noticed that on March 15, 1972, WO exclusively reported that Nixon's bagman and political mastermind, Murray M. Chotiner, was surreptitiously channelling funds to the pro-Communist People's Party. The purpose of the operation was to draw left-wing votes from Democrat candidates. This was the first reported act of sabotage against the Democrats.

On May 1, 1972, WO exclusively reported: "... In his desire to run as the 'Peace President' in November 1972, President Nixon has let the Kremlin leaders know that he is ready to grant them—and help them assert—suzerain rights in all Western Europe, as well as in Germany and in the Soviet-occupied countries of Central and Eastern Europe." The current conference on European security in Helsinki and the moves afoot to recognize the Soviet puppet regime of East Germany as a sovereign government doom the hopes of the reunification of Germany which were raised by the solemn pledges of the United States, Great Britain and France at the time of the founding of the North Atlantic Treaty Organization (NATO). WO exclusively predicted that Nixon, ... would agree to ... in Europe.

On May 15, 1972, WO exclusively forecast: "As President Nixon departs for Moscow, one of the goodies he takes for Chairman Leonid Brezhnev

Editor:

As a new subscriber to THE AMERICAN MERCURY please allow me to inform you how much I enjoyed the Summer, 1972 issue. I am taking advantage of your order blank to order back issues of this marvelous magazine. What a shame you are prohibited from newsstand sales. How pitiful that more people are not aware of your magazine. Of course, the most pitiful thing of all is that the working, middle-class citizen of this "once-great" America of ours, feels so helpless.

As a new subscriber I want to express my heartfelt appreciation for your attempt to wake up the citizens of these United States. You and Liberty Lobby are doing a great service, and I only wish that I were financially able to really be of help.

JOY D. GREEN
South Gate, Calif.

Editor:

Does Mr. Buckley get his anti-toxin shots from ADL? He seems to be immune from character assassination. Senators Goldwater, the late Robert A. Taft, Sr., Joe McCarthy, Gen. MacArthur, Gov. Wallace, and patriotic groups including LIBERTY LOBBY never escape the poison pen of ADL. So maybe perfidy and duplicity is not so foreign to his political stance. At any rate, WASHINGTON OBSERVER NEWSLETTER has about convinced me. At least, Mr. Buckley's conservatism doesn't go beyond the point of: "Hang your clothes on a hickory limb, but don't go near the water."

H. J. WILLIAMS
Madison, Ohio

Editor:

One of the most frequent complaints heard around election time is "there's no real choice; you just have to pick the lesser of two evils."

How often does it occur to us that the lesser of two evils is still evil? And that's the whole point: The present election system doesn't really give us a choice. In many cases, "there ain't a dime's worth of difference" between the Democrat and Republican candidates.

What we need is one more position on the ballot for each elective office. We need a block labelled "NONE OF THE ABOVE" so we can reject ALL of the "me-too" candidates who offer us no real choice.

For more information on protesting against the present election system and appropriate bumper stickers, write:

League of Non-Voters
Box 1406
Santa Ana, Calif. 92702
DAVID MICHAEL MYERS
La Plata, Maryland

WINTER, 1972

Editor:

Enclosed please find a check in the amount of seven dollars for which I would like you to send my twenty (20) copies of the Tax Strike Issue of THE AMERICAN MERCURY.

I am glad that you have had the courage to publish this issue and I hope that you will keep right on in this matter. It is long overdue. I feel that this is the only way left to us to overcome this conspiracy to destroy us and our country. This action, as I see it, is *Constitutional*.

We are cowards if we do not act. I am seventy-two years of age, am self-employed, and do not have a socialistic security number. I stand on my own feet.

Please give me all the information you can.

A. B. MARTIN
Ellenton, Florida

Editor:

Your articles in AMERICAN MERCURY have been very interesting although those on "The Economy" and "The Money Supply" are partially hogwash. I don't object when a writer expresses his opinion even though different from mine, but when you make a statement in your Newsletter which is in error (#145, Sept. 15th, 1972, last page) quote, "for every dollar . . . the national debt which has been manufactured by bookkeeping entry," you are in error. The real truth is that the entry is not *manufactured* but is very real.

The process is that the U.S. Treasurer has a supply of unsigned engraved U.S. Government Bonds which when the Fed "buys bonds" are taken to the U.S. Treasurer who signs them, returns them and then the Fed "buys" them by running off on a printing press an equivalent amount of fiat paper labelled "Treasury Notes" such as used by the public. These notes are no longer "redeemable in lawful money of the U.S." as they used to be because there is none. Only a relatively small amount of illegally debased coinage. These notes have no value being merely paper with ink on them.

Meanwhile, the American Public pays interest on the U.S. Government Bonds to the tune of over \$15,000,000,000 (Fifteen Billion Dollars) every year.

That certainly is not a manufactured book-keeping entry. The Treasury notes are phoney but the Bonds in possession of the Fed are very real, also the interest as it comes due.

LOUIS L. HICKS
Houston, Texas

65

2/2/73

A I R T E L

TO: ACTING DIRECTOR, FBI (157-26763)

FROM: SAC, SAN DIEGO (157-1820)(C)

SUBJECT: WILLIAM FRANCIS YAKOPEC
EM - SAO
(OO: San Diego)

Re San Diego airtel and LHM to Bureau, 11/1/72.

Enclosed for the Bureau are five (5) copies of an LHM r^egarding captioned subject.

One (1) copy of the enclosed LHM has been disseminated locally to the United States Secret Service, inasmuch as the Secret Army Organization (SAO), and its members, present a potential for violence.

Two (2) copies of an FD 376 are attached to the Bureau copies.

Subject is not being recommended for the ADEX in view of his conviction and long prison sentence.

2 - Bureau (Enc. 5)(RM)
3 - San Diego
(2 - 157-1820)
(1 - 157-2815)
EMP/lpo
(5)



157-2815-355

SEARCHED INDEXED
SERIALIZED FILED

San Diego, California

February 2, 1973

WILLIAM FRANCIS YAKOPEC

On October 2, 1972, William Francis Yakopec, an alleged member of the Secret Army Organization (SAO), was found guilty in Superior Court of the County of San Diego on charges of igniting and exploding a destructive device; assault with intent to commit murder; simple assault; assault with a deadly weapon on a police officer, and possession of explosives near a habitation. The charge of attempted murder resulted from the bombing of the Guild Theatre, 3827 Fifth Avenue, San Diego, California, on June 19, 1972.

The Secret Army Organization (SAO) is an anti-Communist, paramilitary organization formed in 1971 in San Diego, California. It intends to conduct intelligence type operations and to offer training in urban guerrilla warfare to be used against "left wing groups" and suspected enemies of the United States.

On October 24, 1972, Larry Wilson, District Attorney's Office, San Diego County, advised that William Francis Yakopec was sentenced on October 24, 1972, to one year to life for assault with a deadly weapon on a police officer and to four other sentences of one to five years to run concurrently on other charges which included assault with intent to commit murder; igniting and exploding a destructive device; possession of other than fixed ammunition; and possession of explosives in or near a place of habitation.

(9)
EMP/lpo (1572815)

This document contains neither recommendations nor conclusions of the FBI. It is the property of the FBI and is loaned to your agency; it and its contents are not to be distributed outside your agency.

157-2815-35
SEARCHED _____ INDEXED _____

WILLIAM FRANCIS YAKOPEC

On November 3, 1972, Yakopec entered a plea of guilty to a lesser charge of possession of inflammable material with intent to burn, before San Diego County Superior Court Judge Gilbert Harelson. He was sentenced to another term of one to five years in the State Prison to run concurrently with the one to life sentence he had previously received. The charge of possession of inflammable material resulted from a follow-up search of his rented home in El Cajon, California, on August 9, 1972. As a result of this search Yakopec was originally charged with possession of explosives. His wife, Deborah Yakopec, age 26, had been arrested on the same charge but was allowed to enter a plea of no contest to a lesser charge of disturbing the peace and was fined \$20 by Judge Harelson.

Investigator Wilson reported that Yakopec was sent to the California State Penal Institution at Chino, California, for a period of observation for 120 days, after which he could be recalled and consideration could be given to a change of sentence.

On January 24, 1973, Investigator Wilson reported that the period of observation for Yakopec at Chino, California, had been terminated and on recommendation by the Court he has been transferred to Vacaville Prison, Vacaville, California, to begin serving the sentence prescribed by law.

Date 11/27/72

PAUL ERWIN RUPLINGER was interviewed at his home at 1367 Massachusetts Street, San Diego, California. He was advised of the identity of the interviewing agents and the purpose of the interview. He furnished the following information:

He denied ever having been a member of the Secret Army Organization (SAO) but has known HOWARD GODFREY for four or five years. He said he was surprised when he learned that GODFREY had been an informant for the FBI for the entire period that he has known him. He once met JERRY LYNN DAVIS through GODFREY. DAVIS was introduced to him as "SAM." He was aware that GODFREY and SAM were involved with the SAO. He denied knowing SY ANDERSON of Seattle, Washington or that he was involved in furnishing guns, ammunition and explosives to SAO members.

RUPLINGER has from time to time given sums of money to GODFREY for use in financing bulletins printed and distributed by the SAO. He furnished this money because of an interest in "survival." At one time he was shown a poster printed on 8 $\frac{1}{2}$ " x 11" paper containing a resume of information extracted from newspapers regarding President NIXON. Later when this poster was printed and distributed, he was surprised to see that it was printed on 8 $\frac{1}{2}$ " x 13" paper, contained a photograph of President NIXON and indicated that he was wanted.

RUPLINGER said his only interest in the SAO was the organization's contribution to "survival." He said he has always had an interest in this matter and has written many pamphlets over the years dealing with this subject. He was at one time a "Survival Consultant." His latest effort in the field of survival was to mastermind an organization called "Virtues in America." He said he had held in setting up the organization but that it failed because of lack of interest. The organization was only interested in pushing survival activity. He would like to reorganize this organization. If he is able to do so he will advise the FBI of his progress and will furnish copies of any literature distributed by him.

On 11/22/72 at San Diego, California File # 157-2815-333
157-3225
 by SAs DWIGHT G. CARRETS III and
MARK H. PETERSON:exp Date dictated 11/27/72

He stated that he is acquainted with General WILLIAM LEMLY, 1536 Glorietta Place, Coronado, California. He met him in connection with an organization called the "Liberty Amendment Committee." This was a movement started by one WILLIS STONE to change or completely eliminate the 16th Amendment to the Constitution. This would eliminate the income tax in the United States. Another goal of the organization was to get the U. S. Government out of all the businesses it runs at a loss.

RUPLINGER stated that he has never been a member of the Minutemen Organization. He met TROY HAUGHTON, the leader of this group twice in 1965 or 1966. The first time he met HAUGHTON, he got into an argument with him when he told him that the Minutemen Organization was inconsistent. He denied knowing anything about the disappearance of HAUGHTON.

RUPLINGER stated that he is not involved in any activity against the best interest of the United States and does not intend to get involved in such activity. He said he does not have in his possession explosives or illegal weapons.

SAC, SAN DIEGO (157-2921) (C)

1/19/73

SA DWIGHT G. GARRETSON

~~INFORMATION~~
~~RONALD-MICHAEL ZARICK, aka~~
EM - SAO
(OO: San Diego)

Re memo of SA DWIGHT G. GARRETSON dated 11/24/72.

On 11/27/72, SA CLAYTON WOLF, Bureau of Alcohol, Tobacco, and Firearms (ATF), San Diego, California, advised that his agency does not currently have a pending investigation regarding the subject. WOLF further advised that an interview of the subject by this Bureau would not interfere with any investigation of ATF.

On 1/15/73, subject was interviewed by SAs DWIGHT G. GARRETSON and EARL M. PETERSEN. He stated that he had never been a member of the Secret Army Organization (SAO), although he had been acquainted with HOWARD GODFREY and TOM FORREST. He also stated that he knew WILLIAM YAKOPEC by sight, but was not personally acquainted with him. He did not know GEORGE MITCHELL HOOVER.

~~INFORMATION~~
~~ZARICK~~ stated that he knew of the existence of the SAO through HOWARD GODFREY, but had never known of any of the activities of this group, and no one had approached him to join this group. He said he did not know JERRY LYNN DAVIS, the leader of this group, although he might have met him, as he is acquainted with various associates of DAVIS.

~~INFORMATION~~
~~ZARICK~~ continued that in the past he had frequented gun shops, gun shows, and gun swap meets, and had frequently bought, sold, and traded guns, gun parts, and ammunition. He stated that he had never dealt in explosives and had never had possession of any explosives. He commented that he might have stated to different individuals that he could get explosives, but explained that any such comments by him would have been for the purpose of keeping the people interested as a prospective customer of his guns, gun parts, or ammunition.

- 1 - 157-2921 ~~INFORMATION~~
- 2 - 170-NEW (~~RONALD-MICHAEL-ZARICK~~)
- 1 - 157-2177 (FORREST)
- 1 - 157- (WILLIAM FRANCIS YAKOPEC)
- ① - 157-2815 (SAO)

DGG:clb
(6)

157-2815-352
no mr
Return of

~~ZARICK~~ denied ever having had possession of a large quantity of ammunition and said he had never had possession of an M-2 conversion kit, although this was possible as he often bought gun parts in large quantities without even knowing what all was contained in the purchase.

~~ZARICK~~ stated that he had known an individual named CY ANDERSON approximately two to three years ago. He explained that ANDERSON would come to San Diego frequently and would visit with ~~him~~ (ZARICK) as well as ~~Tom~~ ~~Tom~~ and other gun dealers in the San Diego area. He said that ANDERSON would buy guns and ammunition in the San Diego area for resale by him in the state of Washington, where he operated a hunting shop.

~~ZARICK~~ was cooperative during this interview and stated that he would be willing to assist this Bureau by furnishing any information which might come to his attention. He was advised of the jurisdiction of the FBI.

As ~~is~~ subject was not a member of SAO or any other extremist organization, this case should be closed.

In view of subject's cooperative attitude, and as he is acquainted with various extremist subjects, it is recommended that a new I70 case be opened and efforts will be made to develop subject as an ~~urban informant~~. PEI.

The following is descriptive data regarding this subject:

Race:	White	<i>Informants IDENTITY</i>
Sex:	Male	
Date of birth:	12/1/43	
Place of birth:	Chicago, Illinois	
Height:	6' 3"	
Weight:	250	
Hair:	Brown	
Eyes:	Brown	
Address:	4146 Illinois Street San Diego, California	
Telephone:	231-3901	

SD 157-2921

INVESTIGATION

Employment:

Conditioned Air
1246 Vernon Way
El Cajon, California

Wife:

ETHEL MYRTIS
679 970 H

FBI Number:

Social Security

Account Number:

California Driver's

License Number:

JFK Act 6 (3)

K 0206192

FBI

Date: 12/13/72

Transmit the following in _____
(Type in plaintext or code)

Via AIRTEL _____
(Priority)

TO: ACTING DIRECTOR, FBI

FROM: SAC, SACRAMENTO (175-55) (P)

SUBJECT: FRANCIS EARL GILLINGS
ALLEGED PLOT TO KILL THE
PRESIDENT - CONSPIRACY
OO: Sacramento

Re Sacramento letter and LHM, 11/21/72, entitled, "JAMES WALTER SCOTT, EM - WNG, OO: Sacramento"; Sacramento airtel and LHM, 11/21/72, entitled, "TAX REBELLION COMMITTEE, EM - WNG, OO: Sacramento"; Sacramento nitel to the Bureau,

- 4 - Bureau
 - (2 - 175-) (FRANCIS EARL GILLINGS)
 - (1 - 175-23577)
 - (1 - 157-21670)
- 2 - Albuquerque (Enc. 3)
- 2 - Chicago (Enc. 3)
- 2 - Detroit (Enc. 3)
- 2 - Kansas City (Enc. 3)
- 3 - Los Angeles (Enc. 2)
- 2 - Mobile (Enc. 3)
- 3 - Phoenix (Enc. 2)
- 2 - Portland (Enc. 3)
- ③ - San Diego (157-2815) (Enc. 2)
- 2 - San Francisco (Enc. 3)
- 9 - Sacramento
 - (2 - 175-55) (1 - 157-2552)
 - (1 - 157-1947) (1 - 157-2569)
 - (1 - 157-2195) (1 - 170-304)
 - (1 - 157-2499) (1 - ELKEA) (DEAD)

TRK:kjr
(36)

CCO make Xerox 157-3579

157-2815-332

SEARCHED INDEXED
SERIALIZED FILED

Petersen 10

SC 175-55

12/4/72; and Bureau airtel to Sacramento, 12/7/72, captioned, "SECRET ARMY ORGANIZATION (SAO), SACRAMENTO DIVISION, EM" and "TAX REBELLION COMMITTEE (TRC), EM - WHG".

Enclosed for Albuquerque, Chicago, Detroit, Kansas City, Mobile, Portland, and San Francisco is one copy each of referenced Sacramento communications.

Enclosed for San Diego is one copy each of Sacramento letter and LHM, airtel and LHM, both dated 11/21/72.

Enclosed for Los Angeles is one copy each of Sacramento airtel and LHM, 11/21/72, and nitel, 12/4/72.

Enclosed for Phoenix is one copy each of letter and LHM, dated 11/21/72 and nitel, 12/4/72.

On 12/5/72, the Bureau advised that information contained in Sacramento nitel to the Bureau, 12/4/72, indicated a possible violation of the assaulting the President of the United States statute and advised Sacramento to immediately institute appropriate investigation in this matter.

By referenced Bureau airtel to Sacramento, 12/7/72, Sacramento was instructed to conduct necessary investigation to determine the extent of the Secret Army Organization's (SAO) presence in this division and comment on its relationship to the Tax Rebellion Committee (TRC).

In addition, the Bureau advised that in view of the extremist remarks of individuals associated with the TRC, preliminary investigation was to be conducted to determine the extent of the TRC's membership's involvement in white extremist activity and other violations within the jurisdiction of the FBI. The Bureau advised that Sacramento was to maintain contact with established sources and informants for

SC 175-55

information regarding the TRC in the above regards but to make certain not to interfere with pending prosecution against JAMES WALTER SCOTT, National Chairman of the TRC, or infringe upon investigative responsibilities of the Internal Revenue Service or other agencies.

In addition, the Bureau has advised that results of investigations of the SAO and TRC are to be submitted in a form suitable for dissemination under respective captioned cases.

In a letter captioned Tax Rebellion Committee, contained in referenced Sacramento airtel and LHM to the Bureau, dated 11/21/72, the leadership of the TRC is set forth. All offices are to review this letter for individuals listed within their territory.

On 12/5/72, ^{Informant} ~~SC 992-FBI~~ advised a meeting was held 12/5/72 at Fresno, California, by a group of persons who do not go by a specific name but who are very anti-Jewish and anti-Negro as well as a tax rebellion group. There were about fifty persons in attendance at this meeting and the speaker was Reverend GAIL from the Los Angeles area.

Source stated that GAIL's speech was extremely anti-Negro and Jew and that he (GAIL) claimed they had to get tough with all the Jewish communists who run congress. GAIL said that this country has to be cleaned up and the only way to accomplish this would be to kill every FBI Agent and every IRS Agent. GAIL further stated that the FBI and IRS Agents should not only be killed but also hung from every telephone pole and mutilated.

Source further related that PAUL TODD claimed he was director of a chapter of the National Association to Keep and Bear Arms (NKKBA), and he lives at P. O. Box 147, Madera, California. TODD further claimed that JIM SCOTT had

SC 175-55

connections in many of the MKBA groups. TODD went on to state that his organization had to be very careful with what they did so that they would not be thought of as the "Secret Army Organization" because some of the people in this organization were radical and thought like the SAC.

Source advised that TODD said all of these organizations like SCOTT's, TRC, the MKBA, and the SAO had to stay in an informal connection with each other so that when the big revolt came, they could all unite; but they should not be too closely united yet or they would be caught and thrown in jail.

On 12/5/72, Lieutenant CLOYCE BROOKSHIRE, Tracy Police Department, advised his files reflect that FRANCIS GILLINGS was arrested 12/8/61 by the Marysville Sheriff's Office, Marysville, California, number A18833, for petty theft and received one year probation.

BROOKSHIRE further advised that his records reflect that GILLINGS has purchased four weapons which include a .32 automatic, a .38 revolver, a .22 revolver, and a .22 automatic.

On 12/7/72, Sergeant KENNETH WAGNER, Intelligence Division, San Joaquin County Sheriff's Office (SJSO), advised his files contain no arrest record for subject; however, his department has contacted GILLINGS on several occasions in regards to GILLINGS confronting his customers with a revolver when he thought they were trying to cheat him. WAGNER advised his intelligence records indicate GILLINGS operates an Arco gas station at U. S. 580 and Patterson Pass Road, Tracy, California, and that he moved to Tracy in 1962 from South Dakota. GILLINGS is married, has four sons, who attend local Tracy schools, and he ran for State Assembly on the American Independent Party ticket.

WAGNER advised that his files indicate subject is "ultra-right wing" and they consider him to be potentially dangerous.

SC 175-55

The following is a description of FRANCIS EARL GILLINGS:

Race: Caucasian
Sex: Male
Date of birth: 7/27/31
Place of birth: Academy, South Dakota
Height: 6' 3"
Weight: 180 pounds
Eyes: Brown
Hair: Brown
Social Security Number: JFK Act 6 (3)
Address: 1826 East Street
Tracy, California
California driver's license number: H337723

On 12/8/72, ^{INFO: M/W} ~~SC 1024-PET~~ advised that it was his understanding that "the movement", as referred to by FRANCIS GILLINGS in his threats against the President and Vice President, was, in fact, the SAO. Source advised that GILLINGS, to date, has not specifically mentioned that he is a member of the SAO. Source further advised that since GILLINGS had just returned from a meeting with JAMES WALTER SCOTT at Fresno, California, he felt the threats against the President were probably a result of GILLINGS discussion with SCOTT.

Source stated that GILLINGS was also very likely trying to impress source and others at the meeting as to his importance in "the movement"; however, in view of the seriousness of the threat, source would continue attempts to learn if this was, in fact, an actual plot against the President.

On 12/9/72, ^{INFO: M/W} ~~SC 1024-PET~~ advised that he had met with ^{INFO: M/W} ~~DAVID E. WILSON~~, a reported leader in the ^{INFO: M/W} ~~Stockton~~ area, and that ^{INFO: M/W} ~~WILSON~~ showed him a copy of a letter he received from the SAO, which is quoted as follows:

DELETED TO PROTECT INFORMANTS

SC 175-55

"SECRET ARMY ORGANIZATION
GENERAL HEADQUARTERS

URGENT

"To all members, supporters, and friends of the SAO. Arrests of many of the members in San Diego have caused some changes of strategy.

"All Post Office Boxes, Drops, Cutouts, and Courier Routes have been discontinued. It is imperative that you do not try to contact the organization in any manner.

"For the next few months our members are being directed to join the John Birch Society under assumed name. The purpose is three fold: The JBS needs the help that our professionals can lend; some of our members need the political training that the JBS can offer; the JBS is a fertile recruiting ground for more militant underground activities.

"You will be contacted at a much later date with further instructions.

"Best wishes and keep your powder dry.

"Lt. Col. Calvin H. Dubbins
"SAO General Staff

"CHD:dgt"

Source advised that according to pamphlets he received from WILSON, the NAKBA has its national headquarters at 909 North Central Avenue, Medford, Oregon.

SC 175-55

~~Phoenix 783-1~~ Previous informant information received from ~~Phoenix 783-1~~ indicates that DAVID L. WILSON has been in communication with the SAO through JAMES KLEIMAN (SC 157-2493).

LEADS:

All offices contact informants and sources in the SAO and TRC and determine if there is a specific plot to assassinate the President and Vice President.

All offices target informants to determine involvement of members of TRC with white extremist activity.

PORTLAND

AT PORTLAND, OREGON. Will conduct preliminary investigation to determine extent of IAKBA membership involvement in white extremist activity.

SAN DIEGO

AT SAN DIEGO, CALIFORNIA. Insure all offices which have SAO chapters are aware of alleged plot to assassinate President and Vice President.

SACRAMENTO

~~Phoenix~~ AT FRESNO, CALIFORNIA. Will continue contact with ~~SC 992-PEI~~ and attempt to establish close coverage of the activities of JAMES WALTER SCOTT.

AT MARYSVILLE, CALIFORNIA. Will review subject's arrest and parole record, Sheriff's Office number A18833, for background information.

AT STOCKTON, CALIFORNIA. Will maintain coverage of subject and associates through ~~SC 1024-PEI~~.

SC 175-55

IN VIEW OF GILLINGS' STATEMENTS, HE SHOULD BE
CONSIDERED ARMED AND DANGEROUS.

FBI

Date: 11/21/72

Transmit the following in _____
(Type in plaintext or code)

Via AIRTEL AIR MAIL
(Priority)

TO: ACTING DIRECTOR, FBI (157-21670)
FROM: SAC, SACRAMENTO (157-1947) (P)
SUBJECT: TAX REBELLION COMMITTEE
WH - WHG
OO: Sacramento

*Indicia search
negative 1/10/73
EAB*

Enclosed for the Bureau are eight copies of an LHM reflecting information on captioned subject.

Information contained in the LHM provided to Agent HARRY GREEN, Internal Revenue Service, Stockton, California on 11/9/72.

The individual providing information to source mentioned in LHM is JAMES CARLYLE CLEHNER, SC 157-2493, 315 South Oro, Stockton, California. CLEHNER is currently under investigation by the Sacramento Division on information received from ~~4-703-2~~ on 10/29/72 and 11/6/72 which indicates CLEHNER has applied for membership in the Secret Army Organization (SAO).

An information copy is being provided to Phoenix in view of their informant coverage.

- 2 - Bureau (Enc. 8)
- 1 - Phoenix (Info)
- 6 - Sacramento
(1 - 170-304)
(1 - 157-) (Secret Army Organization)
- (1 - 157-2493) (JAMES CARLYLE CLEHNER)
- (1 - 65-21)

[Handwritten signature]

157-2815-331
SEARCHED _____
SERIALIZED 4/11/73

Petersen *[Handwritten mark]*

TRK/dgr

SC 157-1947
TRK/dqr

INFO. RAK

Source is ~~SC-1024-PEI-UD~~ and located in instant
LHM.

LEAD

SACRAMENTO

INFO. RAK AT STOCKTON, CALIFORNIA: Will continue contact
with ~~SC-1024-PEI-UD~~ for further details on captioned subject
as well as information on the operation of the SAO.



UNITED STATES DEPARTMENT OF JUSTICE

FEDERAL BUREAU OF INVESTIGATION

Sacramento, California

November 21, 1972

In Reply, Please Refer to
File No.

TAX REBELLION COMMITTEE

On November 9, 1972, a confidential source with whom contact has been insufficient to determine reliability advised he learned through an individual who claims to be a member of the Tax Rebellion Committee (TRC) that in the near future members of the committee plan to place seizure notices, like those used by the Internal Revenue Service (IRS), on property and automobiles.

Literature handed out by the National Tax Rebellion Committee indicates its national headquarters are located at Box 666, Clovis, California, and the purpose is to oppose the "unlawful graduated income tax and revolt against paying this tax".

Source stated he received numerous handouts from the above-mentioned individual and a copy of items listed below are attached hereto:

1. Instructions on how to order and place "Seizure" notices.
2. Xerox copy of "Seizure" notices, original of which was blue in color and on a 5½ inch by 8½ inch card.
3. Copy of literature commencing Dear Jim and signed by Myron L. Katzenback.
4. Copy of W-4 form (Withholding Exemption Certificate).

This document contains neither recommendations nor conclusions of the FBI. It is the property of the FBI and is loaned to your agency; it and its contents are not to be distributed outside your agency nor duplicated within your agency.

TAX REBELLION COMMITTEE

5. Copy of literature entitled Tax Rebellion Committee and commencing "October 1972, Dear Patriot" and signed "Constitutionally yours, Tax Rebellion Committee".

Tax fighters: enclosed warning notice is more powerful than a stick of dynamite!!

We propose that thousands of these be placed on property and on automobiles. An avalanche of telephone calls will hit IRS offices. Irrate, apathetic, silent, easy going tax victims will suddenly be shocked into the real knowledge that the IRS agents who parades as a respectable citizen is in fact a thug, gangster armed with tyrannical power.

We propose that you order 100, 200, 300, or more of these at 5 cents each and place them on automobiles and other property. This placement should be done in such a way as not to be detected by anyone. Four or five fast workers dedicated to the movement can scotch tape 100 on property and automobiles within an hour. Placement should be on windshield or on drivers side of car, cars that are parked for the night when dawn break and sleepy citizens arouse themselves to do daily toil for the tax gatherers. They will discover that their car has been seized.

Pandemonium will break loose.

As mentioned above, order the number of seizure notices you desire at 5 cents each. Order from your tax friends in Fresno. You are aware of the exact name of the group and the address. When ordering please use cash instead of checks. As you well know checks create evidence. You will understand. The enemy is all around us as we take the offensive and move to attack.



WARNING

UNITED STATES GOVERNMENT SEIZURE

*This property has been seized for nonpayment of internal revenue taxes,
by virtue of levy issued by the District Director of Internal Revenue.
All persons are warned not to remove or tamper with this property, in
any manner, under severe penalty of the law.*

Lloyd Fries
REVENUE OFFICER

PUBLICATION NO. 34 (REV. 8-66)

U.S. TREASURY DEPARTMENT • INTERNAL REVENUE SERVICE

Sept. 22/72
2640 Birdseye Cr. Rd.
Gold Hill, Ore. 97525

Dear Jim,

On Sept 20, 1972 at 10 A.M. at my home, 2 I.R.S. Agent's arrived. They came with 18 witnesses, 6 or more tape recorders and many cameras along with 3 visible loaded weapons. To make matters worse we had a prepared list of questions that we insisted be answered first before they could conduct their interview with me. Needless to say we soon put them down and the Special Agent from Portland (Mr. John Keith) even admitted that he was in quite a dilemma. He only managed to present me with a copy of my inflated W-4 form and ask if I indeed did have and claim 21 dependents. At this time I advised him that I would stand on the 5th Amendment of the Constitution.

At 4 p.m. the same day at 909 W. Central St. Medford we again assemble in and for the defense of Mr. Art Holbein. Again the same results.

Many thanks to you Sir, your help to me on the great Memorial Day weekend at your office along with the literature and personal guidance have this day helped this small band of patriots prevail.

Very truly yours
Ernest J. Katzenbach

Form **W-4E**
Department of the Treasury
Internal Revenue Service

Withholding Exemption Certificate

(For use by employees who anticipate no tax liability for 1972.)

1972

Type or print full name

Social Security Number

Expiration date (see instructions and enter date)

Home address (Number and Street)

City, State, and ZIP Code

Employee.—File this certificate with your employer. Otherwise he must withhold Federal income tax from your wages.

Employer.—Keep this certificate with your records. This certificate may be used instead of Form W-4 by those employees qualified to claim the exemption.

Employee's certification.—Under penalties of perjury, I certify that I incurred no liability for Federal income tax for 1971 and that I anticipate that I will incur no liability for Federal income tax for 1972, under the Laws of the Land and the U.S. Constitution, Art. I, Sections 8 and 10 (Signature) & Amend's. V, IX & X.

(Date)

Form **W-4E**
Department of the Treasury
Internal Revenue Service

Withholding Exemption Certificate

(For use by employees who anticipate no tax liability for 1972.)

1972

Type or print full name

Social Security Number

Expiration date (see instructions and enter date)

Home address (Number and Street)

City, State, and ZIP Code

Employee.—File this certificate with your employer. Otherwise he must withhold Federal income tax from your wages.

Employer.—Keep this certificate with your records. This certificate may be used instead of Form W-4 by those employees qualified to claim the exemption.

Employee's certification.—Under penalties of perjury, I certify that I incurred no liability for Federal income tax for 1971 and that I anticipate that I will incur no liability for Federal income tax for 1972, under the Laws of the Land and the U.S. Constitution, Art. I, Sections 8 and 10 (Signature) & Amend's. V, IX & X.

(Date)

Suggested instructions: Keep one W-4E form; give one to your employer; and send one to the I.R.S. "Official Notice To Stop Withholding ..."

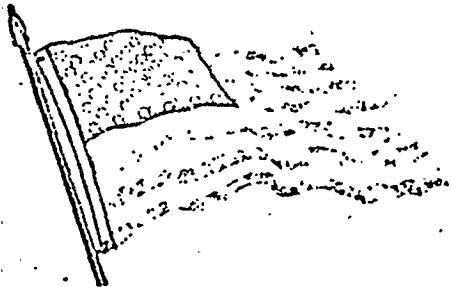

TAX REBELLION COMMITTEE



Jim Scott
National Chairman

KILL THE INCOME TAX - THE ROOT OF ALL EVIL

1843 E. BELMONT FRESNO, CA 93701

Either National or International

ADVISORS:

EDMON KAISER, D.C.
FREMONT, CA.

DERRELL DAY
FRESNO, CALIF.

EDWARD DIETZ, DDS
FRESNO, CALIF.

CLEMENT TAVARES, M.D.
FRESNO, CALIFORNIA

ANITA KERNS, PUBLISHER
LOS ANGELES, CALIF.

GORDON L. CRUIKSHANK, ARCH-BISHOP
ROLLING MEADOWS, ILLINOIS

BILL GARDINER
OTTER ROCK, ORE.

LAURENCE SMIT
EOLIKES, MO.

FRANCIS GILLINGS, PROP.
TRACY, CALIF.

KATHRYN M. DEATS
ALBUQUERQUE, N.M.

CHURCH E. MURDOCK, JR.
MOBILE, ALABAMA

JIM FREED
LANSING, MICH.

OCTOBER 1972

DEAR PATRIOT,

WILL YOU SERIOUSLY CONSIDER INSTALLING A TELEPHONE MESSAGE MACHINE IN YOUR AREA? THIS AMOUNTS TO A MINATURE BROADCASTING STATION WITH A 24 HOUR A DAY TAX REBELLION MESSAGE. SUCH A MACHINE CAN BE PURCHASED FROM A PRIVATE FIRM OR CAN BE RENTED FROM THE TELEPHONE COMPANY FOR A MONTHLY FEE. THE MESSAGE IS APPROXIMATELY 2 MINUTES LONG. PLEASE CALL THE FRESNO NUMBER ON THE ENCLOSED PINK CARD FOR EXAMPLE. IF YOU DESIRE WE COULD FURNISH THE SAME MESSAGE FOR YOUR MACHINE THAT IS NOW ON THE FRESNO MACHINE, WITH YOUR LOCAL ADDRESS ON THE END OF THE MESSAGE. WE WILL FURNISH TO YOU THE CARDS ENCLOSED WITH YOUR LOCAL NUMBER AT THE ROCK BOTTOM COST OF PRINTING. BEST OF ALL AT THE END OF THE MESSAGE WOULD BE YOUR LOCAL ADDRESS AND WHEN YOU RECIEVE ORDERS FOR THE PACKETS AT \$5.00 EACH SEND US \$2.00 AND WE WILL MAIL PROMPTLY TO THE PURCHASER. THIS WILL ALLOW YOU A PROFIT OF \$3.00 PER PACKET TO COVER COST OF THE MACHINE AND THE RELATED EXPENSES. WE MUST USE EVERY AVENUE TO SAVE WHAT IS LEFT OF OUR REPUBLIC. KEITH MCCORMAC INFORMS US THAT 2 MACHINES ARE NOW OPERATING IN BAKERSFIELD WITH 1800 CALLS PER WEEK BEING RECEIVED. LET'S HIT THE ENEMY WITH ALL WE'VE GOT. THE TELEPHONE MESSAGE IS ONE OF THE BEST WAYS TO DO IT.

13

ACTING DIRECTOR, FBI (157-21670)

11/21/72

SAC, SACRAMENTO (157-1947) (P)

JAMES WALTER SCOTT

SI - WEG

OO: SC

Enclosed for the Bureau are seven copies of an LHM regarding subject and one copy each of seizure notice and accompanying letter explaining it.

Enclosed for Los Angeles are two copies of an LHM regarding subject and one copy each of seizure notice and accompanying letter explaining it.

ADMINISTRATIVE:

One extra copy of attached LHM is enclosed to the Bureau for dissemination to IRS.

Confidential source referred to in LHM is ¹⁵⁷⁻²¹⁶⁷⁰~~93-892-FBI~~.

On 11/14/72, JIM FLICK, Special Agent, IRS, advised that he received information through a confidential source that unknown subjects were preparing to attach large numbers of Federal Government IRS seizure notices on private property such as automobiles, etc., in an effort to cause citizens to become angered at the IRS.

FLICK provided a copy of the seizure notice and an accompanying letter explaining it. It is assumed that above-captioned subject is responsible for the scheme.

2 - Bureau (Encs. 9)
2 - Los Angeles (Encs. 4)
2 - Sacramento

JBJ:cea

(6) *cea*

157-2815-330
SEARCHED _____ INDEXED _____
SERIALIZED *4* FILED *MS*

SC 157-1947

AUSA THOMAS COONIS, Fresno, California, advised that the printing, distribution, and attaching of such seizure notices is a possible violation of Title 18, USC, Sections 506, 507, 912, 1017, and 1717.

It is noted that on the letterhead of the Tax Rebellion Committee stationery (of which SCOTT is the national chairman) it lists the Board of advisors for the committee. Among the names listed is ANITA KERN, publisher, Los Angeles, California.

It is also noted that SCOTT puts out, through his Fresno office, a voluminous amount of printed material advocating the nonpayment of taxes.

The possibility exists that this material is being published by ANITA KERN.

LEADS

LOS ANGELES

AT LOS ANGELES, CALIFORNIA

Conduct credit and arrest and indices checks on ANITA KERN and attempt to ascertain if she is the source of printed material for the Tax Rebellion Committee. Particularly, ascertain if she is involved in the printing of copies of Federal Government IRS Seizure Notices.

SACRAMENTO

AT FRESNO, CALIFORNIA

Will, through logical sources, attempt to ascertain if subject is responsible for the distribution and attaching of the seizure notices.

IN VIEW OF SCOTT'S STATEMENTS, HE SHOULD BE CONSIDERED ARMED AND DANGEROUS.

Sacramento, California 95813

November 21, 1972

JAMES WALTER SCOTT

On September 29, 1972, Roger Smith, Intelligence Agent, Internal Revenue Service, U. S. Department of Treasury, Fresno, California, advised that Scott continues to reside at 482 North Poplar, Apartment C, Fresno, California, and that he still maintains his insurance office at 1843 East Belmont, Fresno. Smith advised that on September 25, 1972, Scott was arrested for violation of two counts of Title 26, U. S. Code, Section 7203 (wilful failure to file income tax returns) for the years, 1969 and 1970. Bond was set at \$10,000 and later reduced to \$5,000 corporate surety bond which Scott posted.

Assistant U. S. Attorney, Thomas Couris, Fresno, advised that Scott's trial on above violation was scheduled for April 17, 1973.

On November 3, 1972, a confidential source who is in a position to know advised that Scott is the National Chairman of the Income Tax Rebellion Committee which advocates the nonpayment of taxes as a protest and a means of combat against the Federal Income Tax.

This source further advised that Scott claims to have many unregistered firearms, one of which he keeps in his car and one he keeps in his top right desk drawer. Scott told this source that if anyone came to confiscate his guns or to arrest him, he would shoot them. He further stated that he would not personally hate the officers, but what they represent.

THIS document contains neither recommendations nor conclusions of the FBI. It is the property of the FBI and is loaned to your agency; it and its contents are not to be distributed outside your agency nor duplicated within your agency.

JAMES WALTER SCOTT

Source further stated that Scott keeps referring to the coming revolution and that "we would have to be so organized that when the revolution comes, all the social science professors and most of the Government bureaucrats could be rounded up and liquidated with as little killing of the populace as possible."

This source further stated that Scott hopes they won't have to kill to save freedom and hopes it can be saved by peaceful means, but is afraid it's too late.

IN VIEW OF SCOTT'S STATEMENTS, HE SHOULD BE CONSIDERED ARMED AND DANGEROUS.

American Volunteer Groups

Brown wrote to John Zemanek (Huntington Beach, Calif.), Head of the AVG. He asked Zemanek to send him any information that he has on the Secret Army Organization in California. He also asked how the AVG's new front, a foundation, was coming along. He also asked Zemanek's opinion of the N.S.R.P. and its leaders.

Communist Activities

Donald Walker (Los Angeles, Calif.), a member of the Patric Militia, called Dr. Roy Brown on the evenings of 2nd and 4th of October, 1972 while Dr. Brown was still in Christoval, Texas. He did this to warn Brown that he thought the Cuban Guerrilla Group that he was mixing with was headed by Communists. He stated that he had just mailed a letter but would send another one right away with more details as the first letter had none on the Cubans. He stated that as he had given the Cuban Leader, Juan Araujo, Commanding Officer, Cuban 2505 Brigade, Brown's address and that Brown ought to know it for his own safety.

The first letter from Walker only contained unimportant information and a crazy poem.

The second letter which was written after the phone calls was more lengthy and gave information on the Cuban Group and Walker's reasons for thinking that the leaders are Communists. He also asked for copies of Bill Hanson's (Vero Beach, Florida) book, City Survival-City Resistance as he wanted them for some of his Survival, Anti-Communist converts.

/ni

James "Blackie" Merrell (Houston, Texas), an old timer of the Waterfront Section of the Communist Party and a former leader of the Communist Group running the National Maritime Union from its inception in 1937 until 1947, showed up as a Delegate at the Texas State Democratic Party Convention in Houston, Texas that was held in September, 1972. He was still up to his old rattle rousing ways and gave out the old commie line to his fellow Democrat delegates. An interesting note to it is that he flashed a current paid up dues receipt in the Masters, Mates & Pilots Union. This means that he holds a current license as a deck officer issued by the United States Coast Guard. This is strange as ALL Communists were supposed to have had their merchant marine papers taken away from them in the late 1940's. This was as a national security measure to insure that no commies would be on American merchant ships. Merrell evidently still has his in violation of the "Validation of Emergency Service" edict out of Washington.

Harold H. Hardin

Date prepared

11/24/72

Date received
11/7/72

Received from (name or symbol number)
~~DL 393-E~~

Received by
SA JOHN L. SPURGERS, JR.

Method of delivery (check appropriate blocks)

in person by telephone by mail orally recording device written by Informant

If orally furnished and reduced to writing by Agent:
Date

Date of Report
10/31/72

Date(s) of activity
10/2 - 31/72

Dictated 11/24/72 to P. EDWARDS

Transcribed N/A

Authenticated by Informant 10/31/72

105-3522*
157-2815*
100

Brief description of activity or material
Current activity of NSRP, SAO, AVG and
New Minutemen.

File where original is located if not attached
170-61A-48

* INDIVIDUALS DESIGNATED BY AN ASTERISK (*) ONLY ATTENDED A MEETING AND DID NOT ACTIVELY PARTICIPATE. VIOLENCE OR REVOLUTIONARY ACTIVITIES WERE NOT DISCUSSED.

Information recorded on a card index by _____ on date _____

Remarks:

- 2 - Atlanta (Page 1)
- ② - San Diego (Page 1)
- 2 - Baltimore (Page 1)
- 2 - Los Angeles (Page 2)
- 2 - Houston (Page 2)
- 3 - Dallas (1 - 170-61A-48)
(1 - 157-2213)(BROWN)
(1 - 157-1592)(MM)

Dissemination to appropriate files being left to the discretion of receiving offices.

1cc to Spurgers
1 x copy to 157-1798
2 x copy to 157-nw (Durbine)

157-2815-329
SEARCHED INDEXED
SERIALIZED FILED
DEC 8 1972
FBI - SAN DIEGO

Searched.....Indexed....
Serialized.....Filed.....
DEC 4, 1972
FBI - DALLAS

To: Director, Att.: _____
 SAC,

- Albany
- Albuquerque
- Alexandria
- Anchorage
- Atlanta
- Baltimore
- Birmingham
- Boston
- Buffalo
- Butte
- Charlotte
- Chicago
- Cincinnati
- Cleveland
- Columbia
- Dallas
- Denver
- Detroit
- El Paso
- Honolulu

- Houston
- Indianapolis
- Jackson
- Jacksonville
- Kansas City
- Knoxville
- Las Vegas
- Little Rock
- Los Angeles
- Louisville
- Memphis
- Miami
- Milwaukee
- Minneapolis
- Mobile
- Newark
- New Haven
- New Orleans
- New York City
- Norfolk

- Oklahoma City
- Omaha
- Philadelphia
- Phoenix
- Pittsburgh
- Portland
- Richmond
- Sacramento
- St. Louis
- Salt Lake City
- San Antonio
- San Diego
- San Francisco
- San Juan
- Savannah
- Seattle
- Springfield
- Tampa
- Washington Field.

Date 12/8/72

RE:

REMARKS:

157-2815

SEARCHED _____	INDEXED _____
SERIALIZED _____	FILED _____
DEC 11 1972	
FBI - SACRAMENTO	

Return to

SAC *John M. [Signature]*

FILE #:

OFFICE Sacramento

Date prepared

12/6/72

Date received

12/4/72

Received from (name or symbol number)

1150 in 1111
~~SC-1024-PDI (UD)~~

Received by

SA THOMAS R. KINBERG

Method of delivery (check appropriate blocks)

in person by telephone by mail orally recording device written by Informant

If oral, furnished and reduced to writing by Agent:

Date

Dictated 12/4/72 to _____

Transcribed 12/8/72 by Emily P. Grey

Authenticated by Informant _____

Date of Report

12/3/72

Date(s) of activity

12/3/72

Brief description of activity or material

Coverage of Secret Army Organization (SAO),
Tax Rebellion Committee, and threat against
the President

File where original is located if not attached

170-304A-1

* INDIVIDUALS DESIGNATED BY AN ASTERISK (*) ONLY ATTENDED A MEETING AND DID NOT ACTIVELY PARTICIPATE. VIOLENCE OR REVOLUTIONARY ACTIVITIES WERE NOT DISCUSSED.

Information recorded on a card index by _____ on date _____

Remarks:

Informant furnished information in written statement; however, because of his inexperience, the information was rewritten by SA THOMAS R. KINBERG.

- 1 - Los Angeles (RM)
 - 1- (Tax Rebellion Committee)
- 2 - Phoenix (RM)
 - 1- 170-37
 - 1- 157-1173
- 1 - San Diego (RM)
 - ① 157-2815
- 4 - Sacramento
 - 1- 157-1947
 - 1- 157-2195
 - 1- 157-2493
 - 1- 175-55

157-2815-306

TRK:epg
(8)

CAUTION

IF MATERIAL IS DISSEMINATED
USE CARE IN PARAPHRASING.
Block Stamp

SEARCHED _____	INDEXED _____
SERIALIZED _____	FILED _____
DEC 8 1972	
FBI - SACRAMENTO	

102743-1254

Stockton, California
December 3, 1972

At about 9:30 p.m. on December 3, 1972, a meeting of the Tax Rebellion Committee was held at the home of ~~FRANCIS GILLINGS~~, 1826 East Street, Tracy, California. Present at the meeting was ~~FRANCIS GILLINGS~~, his son ~~JAMES GILLINGS~~, ~~GEORGE BOOFER~~, and ~~JAMES KLEIMAN~~.

After a short social meeting in GILLINGS' house, the group moved out of the house and into GILLINGS' car, a late model four-door white Imperial, where the discussion began. JAMES KLEIMAN mentioned that GILLINGS had missed several meetings at his house in Stockton, California, and when GILLINGS apologized and explained he was extremely busy with the Tax Rebellion business, KLEIMAN then asked when they would start using their ammunition, referring to the IRS "seizure" notices.

GILLINGS stated that he had just returned from a meeting with JIM SCOTT of Fresno, and that after he and SCOTT returned from the San Diego Eleven trial, they would get the ball rolling in conjunction with other groups in California. GILLINGS also mentioned the name of ANITA KERNS in conjunction with the meeting of SCOTT in Fresno, but her position in the conversation was not clear.

GEORGE BOOFER stated that a few individuals distributing the "seizure notices" in California would make little impact.

KLEIMAN mentioned that he thought the literature was being intercepted in the mails as they were having trouble getting materials.

FRANCIS GILLINGS remarked that it was common knowledge that the U. S. Postal Service was a bunch of crooks, so the material is put in an envelope and mailed

*EXCERPT BECAUSE THE INFORMATION NOT
PERTAINING TO SAO*

with a return address that was picked out of the phone book at random. That way if it was seized, the return address would be an innocent victim and would raise hell if he was tabbed as the sender.

GILLINGS further related that some time after December 6, 1972, he would contact KLEIMAN and in the meantime they were to try to recruit some SDS members from the campus of San Joaquin Delta College and University of the Pacific to help distribute the seizure notices. He advised all packages were to be packaged with rubber gloves and a half of a \$10 bill was to be mailed with the seizure notices and a letter explaining the time, date of placement, and the area to be covered. When the notices were placed, the other half of the \$10 bill would be mailed to the persons placing the seizure notices.

GILLINGS advised that after January 1, 1973, he was going to buy ten-second spots on TV, advising taxpayers that the only way to pay their taxes is by tearing up their return forms. He also mentioned that the movement was going to advertise on radio and in the "Stockton Record" for salesmen to sell a special tax package at \$5 each with a profit of \$4 for the salesman.

GILLINGS advised he would call KLEIMAN and BOOFER to notify them of the date to prepare plans for distribution of seizure notices.

GILLINGS also advised during the meeting that a complete and total collapse of the United States Government was approaching. All big banking institutions were shipping their gold to Europe in preparation for this financial depression and the rise in the Dow Jones averages was a ruse to throw off the American public to the situation at hand. He related that this information was relayed to him from a high-up government source and this collapse was coming within the next 30 to 180 days.

EXCISED BECAUSE INFORMATION NOT
RELEVANT TO SDP

Excised by SA [unclear]

GILLINGS then said that some people in the movement were planning to assassinate the President and Vice President of the United States. He related that plans were being laid to assassinate them when they were together at the same time and certain judges were being selected as targets because of their leftist tendencies. He advised that some members of the law enforcement agencies were in sympathy with their plans.

JAMES KLEIMAN remarked that it was about time Comrade KISSINGER and his flunkies, NIXON and AGNEW, were dealt with in the right manner..

During the meeting, JAMES GILLINGS showed that he was carrying a .22 revolver on his side and stated it was ready for action.

After the meeting, ~~KLEIMAN~~ mentioned that certain Secret Army Organization members had infiltrated certain communist groups and were being assigned target members to be killed off when the time for rebellion was launched.

FBI

Date: 12/4/72

Transmit the following in CODE
(Type in plaintext or code)

Via TELETYPE NITEL
(Priority)

TO ACTING DIRECTOR ATTN: D I D
FROM SACRAMENTO (175-0) (5P)

175-51x NI

FRANCIS EARL GILLINGS; EM - THREATS AGAINST THE PRESIDENT.

RESCAIRTEL TO BUREAU ELEVEN TWENTYONE SEVENTYTWO CAPTIONED
TAX REBELLION COMMITTEE, EM - WHG.

ON TWELVE FOUR INSTANT A CONFIDENTIAL SOURCE WITH WHOM CONTACT
HAS BEEN INSUFFICIENT TO ESTABLISH RELIABILITY BUT WHO HAS FUR-
NISHED INFORMATION IN PAST THAT HAS BEEN CORROBORATED BY OTHER
SOURCES, ADVISED THAT ON EVENING TWELVE THREE SEVENTYTWO THERE
WAS A MEETING OF TAX REBELLION COMMITTEE AT HOME ~~FRANCIS EARL~~
~~GILLINGS ONE EIGHT TWO SIX EAST STREET, TRACY CALIF. INITIAL PORTION~~
~~OF MEETING SPENT DISCUSSING PLANS FOR PLACEMENT IRS SEIZURE NOTICES~~
~~STOCKTON CALIF. AREA. SOURCE STATED SUBJECT THEN CLAIMED THAT~~
~~U.S. GOVERNMENT WAS ON VERGE TOTAL FINANCIAL COLLAPSE, THAT ALL~~
~~BIG BANKING INSTITUTIONS SHIPPING THEIR GOLD TO EUROPE IN PREP-~~
~~ARATION FOR FINANCIAL DEPRESSION AND THAT RISE IN DOW JONES~~
~~AVERAGES WAS RUSE TO THROW OFF AMERICAN PUELIC TO SITUATION AT~~

Change Because NY Informant NT Return of TO SAC

157-2815-325

END PAGE ONE
SANDIE 90 (157-SAC) (AM)

TRK/LCH

SEARCHED <input checked="" type="checkbox"/>	INDEXED <input checked="" type="checkbox"/>
SERIALIZED <input checked="" type="checkbox"/>	FILED <input checked="" type="checkbox"/>
DEC 7 - 1972	
FBI - SACRAMENTO	

Belmont

F B I

Date:

Transmit the following in _____
 (Type in plaintext or code)

Via _____
 (Priority)

PAGE TWO

SC 175-Ø

EXCISED BY [unclear] ON [unclear] [unclear] 10510

HAND. SUBJECT CLAIMED COLLAPSE WAS COMING WITHIN NEXT THIRTY TO ONE HUNDRED EIGHTY DAYS AND SOME PEOPLE IN " THE MOVEMENT " PLANING ASSASSINATE PRESIDENT AND VICE PRESIDENT OF U.S. DURING THIS PERIOD. GILLINGS RELATED PLANS BEING MADE TO ASSASSINATE THEM WHEN THEY WERE TOGETHER AT SAME TIME.

SOURCE ADVISED SUBJECT CLAIMED CERTAIN JUDGES, NAMES NOT GIVEN, WERE BEING SELECTED ALSO AS TARGETS BECAUSE OF LEFTIST TENDENCIES.

SOURCE ADVISED JAMES CARLYLE KLEIMAN, THREE ONE FIVE SOUTH ORO ST. STOCKTON CALIF. REMARKED THAT IT WAS ABOUT TIME COMRADE KISSINGER AND HIS FLUNKIES NIXON AND AGNEW WERE DELT WITH IN THE RIGHT MANNER.

SOURCE ADVISED THAT AFTER MEETING ~~KLEIMAN~~ MENTIONED CERTAIN MEMBERS OF SECRET ARMY ORGANIZATION (SAO) HAD INFILTRATED CERTAIN COMMUNIST GROUPS AND WERE BEING ASSIGNED TARGET MEMBERS TO BE KILLED OFF WHEN TIME FOR REBELLION WAS LAUNCHED.

END PAGE TWO

Approved: _____ Sent _____ M Per _____
 Special Agent in Charge

FBI

Date:

Transmit the following in _____
(Type in plaintext or code)

Via _____
(Priority)

PAGE THREE

SC 175-0

THE SAO IS AN ANTICOMMUNIST, PARAMILITARY ORGANIZATION FORMED IN ONE NINE SEVEN ONE IN SAN DIEGO, CALIF. IT INTENDS TO CONDUCT INTELLIGENCE TYPE OPERATIONS AND TO OFFER TRAINING IN URBAN GUERRILLA WARFARE TO BE USED AGAINST "LEFT WING GROUPS" AND SUSPECTED ENEMIES OF THE UNITED STATES.

SOURCE RELATED THAT GILLINGS CLAIMED HE HAD JUST RETURNED FROM FRESNO, CALIF. WHERE HE MET WITH JAMES WALTER SCOTT, PUBLICALLY IDENTIFIED AS NATIONAL CHAIRMAN, TAX REBELLION COMMITTEE, ONE EIGHT FOUR THREE EAST BELMONT FRESNO, CALIF.

A SECOND SOURCE WHO PROVIDED RELIABLE INFORMATION IN THE PAST ADVISED TWO ELEVEN SEVENTYONE THAT SCOTT FURNISHED MINUTEMAN APPLICATION FORM AND WAS ON MAILING LIST OF MINUTEMAN ORGANIZATION.

THE MINUTEMEN IS A PARAMILITANT GROUP ORGANIZED IN JUNE, ONE NINE SIX ZERO, BY ROBERT B. DEPUGH IN NORBORNE, MISSOURI, AS A
END PAGE THREE

EX-100-3-10-11-12-13-14-15-16-17-18-19-20-21-22-23-24-25-26-27-28-29-30-31-32-33-34-35-36-37-38-39-40-41-42-43-44-45-46-47-48-49-50-51-52-53-54-55-56-57-58-59-60-61-62-63-64-65-66-67-68-69-70-71-72-73-74-75-76-77-78-79-80-81-82-83-84-85-86-87-88-89-90-91-92-93-94-95-96-97-98-99-100-101-102-103-104-105-106-107-108-109-110-111-112-113-114-115-116-117-118-119-120-121-122-123-124-125-126-127-128-129-130-131-132-133-134-135-136-137-138-139-140-141-142-143-144-145-146-147-148-149-150-151-152-153-154-155-156-157-158-159-160-161-162-163-164-165-166-167-168-169-170-171-172-173-174-175-176-177-178-179-180-181-182-183-184-185-186-187-188-189-190-191-192-193-194-195-196-197-198-199-200-201-202-203-204-205-206-207-208-209-210-211-212-213-214-215-216-217-218-219-220-221-222-223-224-225-226-227-228-229-230-231-232-233-234-235-236-237-238-239-240-241-242-243-244-245-246-247-248-249-250-251-252-253-254-255-256-257-258-259-260-261-262-263-264-265-266-267-268-269-270-271-272-273-274-275-276-277-278-279-280-281-282-283-284-285-286-287-288-289-290-291-292-293-294-295-296-297-298-299-300-301-302-303-304-305-306-307-308-309-310-311-312-313-314-315-316-317-318-319-320-321-322-323-324-325-326-327-328-329-330-331-332-333-334-335-336-337-338-339-340-341-342-343-344-345-346-347-348-349-350-351-352-353-354-355-356-357-358-359-360-361-362-363-364-365-366-367-368-369-370-371-372-373-374-375-376-377-378-379-380-381-382-383-384-385-386-387-388-389-390-391-392-393-394-395-396-397-398-399-400-401-402-403-404-405-406-407-408-409-410-411-412-413-414-415-416-417-418-419-420-421-422-423-424-425-426-427-428-429-430-431-432-433-434-435-436-437-438-439-440-441-442-443-444-445-446-447-448-449-450-451-452-453-454-455-456-457-458-459-460-461-462-463-464-465-466-467-468-469-470-471-472-473-474-475-476-477-478-479-480-481-482-483-484-485-486-487-488-489-490-491-492-493-494-495-496-497-498-499-500-501-502-503-504-505-506-507-508-509-510-511-512-513-514-515-516-517-518-519-520-521-522-523-524-525-526-527-528-529-530-531-532-533-534-535-536-537-538-539-540-541-542-543-544-545-546-547-548-549-550-551-552-553-554-555-556-557-558-559-560-561-562-563-564-565-566-567-568-569-570-571-572-573-574-575-576-577-578-579-580-581-582-583-584-585-586-587-588-589-590-591-592-593-594-595-596-597-598-599-600-601-602-603-604-605-606-607-608-609-610-611-612-613-614-615-616-617-618-619-620-621-622-623-624-625-626-627-628-629-630-631-632-633-634-635-636-637-638-639-640-641-642-643-644-645-646-647-648-649-650-651-652-653-654-655-656-657-658-659-660-661-662-663-664-665-666-667-668-669-670-671-672-673-674-675-676-677-678-679-680-681-682-683-684-685-686-687-688-689-690-691-692-693-694-695-696-697-698-699-700-701-702-703-704-705-706-707-708-709-710-711-712-713-714-715-716-717-718-719-720-721-722-723-724-725-726-727-728-729-730-731-732-733-734-735-736-737-738-739-740-741-742-743-744-745-746-747-748-749-750-751-752-753-754-755-756-757-758-759-760-761-762-763-764-765-766-767-768-769-770-771-772-773-774-775-776-777-778-779-780-781-782-783-784-785-786-787-788-789-790-791-792-793-794-795-796-797-798-799-800-801-802-803-804-805-806-807-808-809-810-811-812-813-814-815-816-817-818-819-820-821-822-823-824-825-826-827-828-829-830-831-832-833-834-835-836-837-838-839-840-841-842-843-844-845-846-847-848-849-850-851-852-853-854-855-856-857-858-859-860-861-862-863-864-865-866-867-868-869-870-871-872-873-874-875-876-877-878-879-880-881-882-883-884-885-886-887-888-889-890-891-892-893-894-895-896-897-898-899-900-901-902-903-904-905-906-907-908-909-910-911-912-913-914-915-916-917-918-919-920-921-922-923-924-925-926-927-928-929-930-931-932-933-934-935-936-937-938-939-940-941-942-943-944-945-946-947-948-949-950-951-952-953-954-955-956-957-958-959-960-961-962-963-964-965-966-967-968-969-970-971-972-973-974-975-976-977-978-979-980-981-982-983-984-985-986-987-988-989-990-991-992-993-994-995-996-997-998-999-1000

Approved: _____ Sent _____ M Per _____

Special Agent in Charge

U.S. Government Printing Office: 1972 - 455-574

FBI

Date:

Transmit the following in _____
(Type in plaintext or code)

Via _____
(Priority)

PAGE FOUR

SC 175-0

*EXCISED BUSINESS INFORMATION IS NOT
PERTINENT TO SAO*

RESISTANCE TO THE SPREAD OF COMMUNISM IN THE UNITED STATES BY USE
OF GUERRILLA TACTICS. DEPUGH IS CURRENTLY INCARCERATED IN A FEDERAL
PENITENTIARY FOR VIOLATION OF THE FEDERAL FIREARMS ACT.

THE PATRIOTIC PARTY HAS BEEN THE POLITICAL ARM OF THE
MINUTEMEN.

A THIRD SOURCE WHO HAS PROVIDED RELIABLE INFORMATION IN THE PAST
ADVISED ON TEN TWENTYNINE SEVENTYTWO THAT JAMES C. KLEIMAN HAD
APPLIED FOR MEMBERSHIP IN SAO.

ADMINISTRATIVE:

FIRST SOURCE IS ~~SC ONE ZERO TWO FOUR PEI UD~~

SECOND SOURCE IS DENNIS PATRICK MOWER FORMER WEST COAST
FUNCTIONARY MINUTEMAN ORGANIZATION (CONCEALED BY REQUEST)

THIRD SOURCE IS ~~PX SEVEN EIGHT THREE E.~~

ON TWELVE THREE SEVENTYTWO AT THREE THIRTY PM SA LEE SCOTT,
SECRET SERVICE ADVISED BY SA THOMAS R. KINBERG, FBI.

SACRAMENTO CONDUCTING INDIVIDUAL INVESTIGATIONS ON ~~CHALLENGES~~ *INDIVIDUAL*

END PAGE FOUR

Approved: _____ Sent _____ M Per _____
Special Agent in Charge

F B I

Date:

Transmit the following in _____
(Type in plaintext or code)

Via _____
(Priority)

PAGE FIVE

SC 175-0

INDIVIDUAL

~~SCOTT AND KLEMAN~~ UNDER APPROPRIATE CAPTION.

AIRMAIL COPIE SENT SAN DIEGO.

E N D

Approved: _____ Sent _____ M Per _____

Special Agent in Charge

SAC, SAN DIEGO (157-3001)

9/25/72

SUPV. ANTHONY J. MALONEY, JR.

GEORGE MITCHELL HOOVER
EM - SAO

JERRY LYNN DAVIS
EM - SAO

The local trials in captioned matters are scheduled as follows:

GEORGE MITCHELL HOOVER	10/25/72
JERRY LYNN DAVIS	11/13/72

As in the YAKOPEC matter, the possibility exists that the defense may demand by subpoena duces tecum the production of all written recordations of information furnished by HOWARD BARRY GODFREY (~~SA 1155-D~~) to the FBI concerning both these subjects. *Informant*

If such a demand pursuant to subpoena duces tecum is honored by court, we must be in a position to immediately furnish three copies of such material to the Bureau by airtel on the date such order may be demanded.

Upon receipt, the Bureau will consult with the Department and thereafter return to San Diego the excised portions of such recordations of which the Department may authorize our furnishing the court.

SA HOOPER should therefore cause to be prepared three xerox copies of each authenticated report of GODFREY (exclusive of the FD 306); each memo reflecting oral information furnished by GODFREY that may inadvertently not have been ^{produced} under an authenticated report and each FD 302 as they relate to HOOVER and DAVIS.

2 - 157-3001
2 - 157-3017
① - 157-2315
AJM:ejt
(5)

CCO
Responsible of
Peterson
10/30

157-2815-291
157-2815-228

SEARCHED	INDEXED
SERIALIZED	FILED
SEP 27 1972	
FBI - SAN DIEGO	

1

TO: SAC, PHOENIX
 FROM: SA, CLARENCE L. CRANDALL

Date prepared
 10/31/72

Date received
 10/27/72

Received from (name or symbol number)
~~PX-783-E~~

Received by
 SA CLARENCE L. CRANDALL

Method of delivery (check appropriate blocks)
 in person by telephone by mail orally recording device written by Informant

If orally furnished and reduced to writing by Agent:
 Date

Date of Report

Dictated _____ to _____

Date(s) of activity

Transcribed _____

October, 1972

Authenticated by Informant _____

Brief description of activity or material

File where original is located if not attached
 Orig. copies returned to
~~PX-783-E~~ *Newman*

Two letters to informant from SAM (Jerry Lynn Davis) indicating that the Secret Army Organization is now defunct. Paraphrased.

* INDIVIDUALS DESIGNATED BY AN ASTERISK (*) ONLY ATTENDED A MEETING AND DID NOT ACTIVELY PARTICIPATE. VIOLENCE OR REVOLUTIONARY ACTIVITIES WERE NOT DISCUSSED.

Information recorded on a card index by _____ on date _____

Remarks:

Source advised that some time during the last two weeks in October, 1972, JERRY LYNN DAVIS, leader of the Secret Army Organization in San Diego, advised one of his close confidants in the SAO that he had discontinued the use of two mail drops, namely: Artist Supply, P. O. Box 503, Lemon Grove, California; Survival Supply, P. O. Box 1362, Spring Valley, California. DAVIS lamented that, because of the current court proceedings against certain members of the SAO in the San Diego area, the SAO has become defunct as an organization; that unaffected elements of the SAO may possibly band together, but probably under a different label. DAVIS indicated that a small pocket of SAO members exist in the Los Angeles area, and two members are in the Seattle area. These were not identified by name.

- ② - San Diego (RM)
- 2 - Los Angeles (RM) info.
- 2 - Seattle (RM) info.
- 2 - Phoenix
- 1 cc 157-1173 (SAO)
- 1 cc 170-37-A

(8)
 CLC/

copy to 100-14297

Block Stamp

157-2815-296

SEARCHED	INDEXED
SERIALIZED	FILED
NOV 13 1972	
FBI - SAN DIEGO	

[Signature]

UNITED STATES GOVERNMENT

Memorandum

TO : SAC (157-2815) (P)

FROM : SA EARL M. PETERSEN

SUBJECT: SECRET ARMY ORGANIZATION
EM

DATE: 11/15/72

On 11/14/72, HOWARD BARRY GODFREY, ~~Formerly SD 155-E~~, advised that on about 11/12/72, RICHARD FLEURY had severely beaten his wife GENEVIEVE. She was so severely injured that her cheek bone was pushed up into her eye and her nose was broken in two places. She was taken to the hospital and surgery was necessary, including going into the top of her head to correct nerve damage.

Source stated that Mrs. FLEURY has been fooling around with GEORGE MITCHELL HOOVER and has been visiting him in jail on a weekly basis. HOOVER had requested that she bring him a map of Mexico. Source speculated that Mrs FLEURY and HOOVER might intend to flee to Mexico if he is ever released on bond. Source stated that it is his understanding that the SDCSO intends to arrest FLEURY on charges of felonious assault.

1 - 157-3017 (Hoover)
1 - 157-3289 (Genevieve Fleury)
1 - 157-3290 (Richard Fleury)
1 - 170-286A
EMP:emp
(5)

157-2815-299

SEARCHED	INDEXED
SERIALIZED <i>AK</i>	FILED <i>116</i>
NOV 16 1972	
FBI - SAN DIEGO	

Petersen



TO: SAC, PHOENIX (157-1173)

Date prepared

10/31/72

Date received
10/27/72

Received from (name or symbol number)
~~PX 783-E~~ / Informant

Received by
SA, CLARENCE L. GRANDALL

Method of delivery (check appropriate blocks)

in person by telephone by mail orally recording device written by Informant

If orally furnished and reduced to writing by Agent:
Date

Date of Report

Dictated _____ to _____

Date(s) of activity

Transcribed _____

9/6/72

Authenticated by Informant _____

Brief description of activity or material
The original application of one JAMES CARLYLE KLEIMAN, Stockton, California, for membership in the SAO.

File where original is located if not attached
Original returned to source, PX 783-E
Mesa Camping Supplies

* INDIVIDUALS DESIGNATED BY AN ASTERISK (*) ONLY ATTENDED A MEETING AND DID NOT ACTIVELY PARTICIPATE. VIOLENCE OR REVOLUTIONARY ACTIVITIES WERE NOT DISCUSSED.

Information recorded on a card index by _____ on date _____

Remarks:

Informant advised that on 9/6/72, one JAMES CARLYLE KLEIMAN, 315 S. Oro Ave., Stockton, California, 95205, executed an application for membership in the Secret Army Organization. The application was mailed to the mail drop "Mesa Camping Supplies, P. O. Box 1432, La Mesa, California 92041."

A Xerox copy of the original application is attached hereto.

CLC/

- 2 - San Diego
- 2 - Sacramento
- 2 - Phoenix
- 1 cc 170-37-A
- 1 cc 157-1173 (SAO)

Block Stamp

157-2815-290

SEARCHED	INDEXED
SERIALIZED	FILED
FBI - SAN DIEGO	
<i>Petersen</i>	

APPLICATION FOR MEMBERSHIP

NOTICE TO APPLICANT: All information on this form will be kept confidential. All records of members of the Secret Army Organization are stored in a way that they can be swiftly destroyed to keep them from falling into unauthorized hands.

Name William C. ... Sex M Age 33

Address 3155 5th St Marital Status Single
(Street)

State PA Wife's Name _____

Zip Code _____ Telephone 412-2779

Date of Birth 2/21/37
(Month) (Day) (Year)

Occupation _____ Education _____

Special Subjects Studied Public Speaking, Organizing, Recruiting

Do You Speak or Read Any Foreign Language? Little Spanish

Veteran Y Branch 11918 Highest Rank PO

What Service Training Have You Had That You Feel Would Be Beneficial To This Organization? Auto School, Business

Physical Description: Height _____ Weight _____ Color Eyes Blue

Color Hair Brown Health: Good Fair _____ Poor _____

Any Physical Disabilities or Limitations? None

Any Public Speaking or Organizing Experience? Yes If Yes, Please Explain: _____

How Many Hours A Week Could You Devote To Working And Training With the S. A. O. ?

Hours _____ Best Time: AM _____ PM _____ Weekdays _____ Weekends _____

CERTIFICATION

I am a loyal American Citizen dedicated to the defense and survival of the United States as a Constitutional Republic, free from all socialist and communist policies. Enclosed is my \$5.00 membership fee. I agree to pay \$3.00 each month to the Secret Army Organization as membership dues.

Signature of Applicant William C. ... Date 9/1/72

**SUPPLY YOUR POLICE
AND KEEP THEM
INDEPENDENT!**

**REGISTER
NOT FEAR**

*Mr. Wallace
Washington
D.C. 20541*

**Get US out!
OF THE UNITED NATIONS**

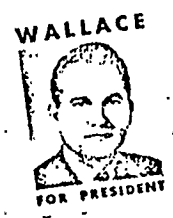
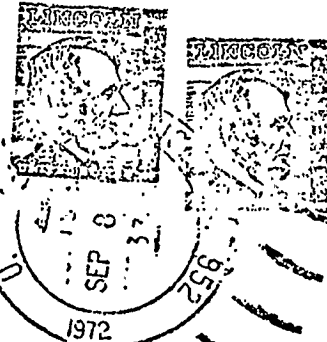

Bob Bink

P.O. Box 172

San Diego, Calif. 92105

S. A. C.

P.O. Box 5791

San Diego, Calif. 92105

As you can tell
the name given is my
nick-name. I receive
all mail at my P.O. and
I am not yet willing to
give phone number.

Everything else is as is.

I did not sign because
I don't know that much
yet to get involved. I am
one of many who are interested
and am to be courteous but
sincere. We all have to be
slow, but sure at this point.
Bob

APPLICATION FOR MEMBER

NOTICE TO APPLICANT: All information on this form will be kept confidential. All records of members of the Secret Army Organization are stored in a way that they can be swiftly destroyed to keep them from falling into unauthorized hands.

Name Robby Bible Sex Male Age 33

Address P.O. Box 171 Long Beach Marital Status single
(Street) never married

State Calif 90801 Wife's Name _____

Zip Code ↑ Telephone none

Date of Birth July 26th 1939
(Month) (Day) (Year)

Occupation Warehouseman Education graduate U.C.L.B.

Special Subjects Studied min in math - Science - P.E.

Do You Speak or Read Any Foreign Language? No

Veteran yes Branch Army Highest Rank SP-4

What Service Training Have You Had That You Feel Would Be Beneficial To This Organization? Basic Training U.S. Army. Qualified Tank Commander + gunner.

Physical Description: Height 5'9" Weight 150lbs Color Eyes GRN

Color Hair BRN Health: Good Fair Poor

Any Physical Disabilities or Limitations? NONE

Any Public Speaking or Organizing Experience? Yes If Yes, Please Explain: _____

I preach the Gospel of our Lord Jesus Christ. we have a Bible study fellowship of which I am the leader-teacher + we are interested

How Many Hours A Week Could You Devote To Working And Training With the S.A.O. ?
in protecting ourselves + our country against communists - atheists

Hours _____ Best Time: AM _____ PM _____ Weekdays _____ Weekends _____

I could / may do anything commensurate with my seeing a need,
Christian CERTIFICATION God +

I am a loyal American Citizen dedicated to the defense and survival of the United States as a Constitutional Republic, free from all socialist and communist policies. Enclosed is my \$5.00 membership fee. I agree to pay \$3.00 each month to the Secret Army Organization as membership dues

Signature of Applicant good Date _____

Don't wait to sign it, pay the \$5 now. But the \$3 is enclosed showing interest.

UNITED STATES GOVERNMENT

Memorandum

TO : SAC, SAN DIEGO (157-2815) (P)

DATE: 10/27/72

FROM : SA FRANCISCO L. CASTRO

SUBJECT: INFORMATION CONCERNING
SECRET ARMY ORGANIZATION
EXTREMIST MATTERS
OO: San Diego

On 10/26/72, at 10:10 AM, Special Agent John Keefe, United States Secret Service, San Diego, California, advised as follows:

On the morning of 10/26/72, an anonymous caller, described only as a male in his 40's, contacted the McGovern Campaign Headquarters at El Cajon, California and stated that the Secret Army Organization (SAO) had attempted to get him to bomb the McGovern Headquarters in the past. Caller stated that an FBI informant offered him explosives but that he, the caller, had refused to do it. Subsequent to his refusal, his business, a Hertz Rental Franchise, located on the 1900 block of Broadway, El Cajon, California, was blown up, causing him to lose his business.

Unknown caller was referred to the McGovern Headquarters in San Diego where caller spoke to Mrs. Joy Mason, and stated that he was afraid to report this information previously but after listening to McGovern on 10/25/72, he thought it was his duty to make the above information public.

Caller stated that he would contact his attorney for advice and recontact the McGovern Headquarters on 10/27/72, at which time he would possibly reveal his identity.

On 10/26/72, Mrs. Joy Mason, McGovern Headquarters, San Diego, California, was contacted by the writer and advised that she had spoken to unknown caller who furnished the same information given by Secret Service. Mrs. Mason stated that unknown caller had promised to recontact them on 10/27/72, after consulting with his attorney since the above information could not be made public unless caller identified himself.

2-San Diego
FLC



5010-108

157-2815-287

SEARCHED	INDEXED
SERIALIZED	FILED
OCT 31 1972	
FBI-SAN DIEGO	

Peterman | *ef*

Buy U.S. Savings Bonds Regularly on the Payroll Savings Plan

TO: SAC, PHOENIX

Date prepared

10/31/72

Date received

10/27/72

Received from (name or symbol number)

~~PX 783-E~~ *W...*

Received by

SA, CLARENCE L. CRANDALL

Method of delivery (check appropriate blocks)

in person by telephone by mail orally recording device written by Informant

If orally furnished and reduced to writing by Agent:

Date

Dictated _____ to _____

Transcribed _____

Authenticated by Informant _____

*76-93384
87-5291**

Date of Report

Date(s) of activity

9/12/72

Brief description of activity or material

Letter from DAVID L. WILSON, P. O. Box 2115, Stockton, California 95201, to the SAO.

File where original is located if not attached

Original returned to source, ~~PX 783-E~~

* INDIVIDUALS DESIGNATED BY AN ASTERISK (*) ONLY ATTENDED A MEETING AND DID NOT ACTIVELY PARTICIPATE. VIOLENCE OR REVOLUTIONARY ACTIVITIES WERE NOT DISCUSSED.

Information recorded on a card index by _____ on date _____

Remarks:

Informant advised that on 9/12/72, one DAVID L. WILSON, P. O. Box 2115, Stockton, California 95201, sent an unsigned communication to the Secret Army Organization through JERRY LYNN DAVIS, National Coordinator, and made reference to his friend JIM KLIEMAN who had made application to join the SAO.

There is attached hereto a Xerox copy of the original letter referred to above.

CLC/

- ② - San Diego
- 2 - Sacramento
- 2 - Phoenix
- 1 cc 170-37-A
- 1 cc 157-1173 (SAO)

157-2815-288

Block Stamp

SEARCHED *WJ* INDEXED *WJ*

FBI - SAN DIEGO

W

Sept. 12, 1972

Dear Sir,

me I recently was informed by my friend Jim Klieman, that he sent for and recieved information on your organization. He tells that you people are interested in the same thing as we are, namèly our constitutional right to keep and bear arms. Jim also said he filled out the application form you sent and is awaiting your reply.

I too, would like informatiøn on your group. As Jim requested I won't show my return address on the outside of this letter. Thank you for your effort.

Sincerely,

David L. Wilson

P.O. Box 2115

Stockton, Ca. 95201

TO: SAC, PHOENIX (157-1173)

Date prepared

10/30/72

Date received

10/26/72

Received from (name or symbol number)

PX-783-E / NTC. [initials]

Received by

SA, CLARENCE L. GRANDALL

Method of delivery (check appropriate blocks)

in person by telephone by mail orally recording device written by Informant

If orally furnished and reduced to writing by Agent:

Date

Date of Report

9/15/72 at Christoval, Texas.

Date(s) of activity

9/15/72 at Christoval, Texas.

Dictated _____ to _____

Transcribed _____

Authenticated by Informant _____

Brief description of activity or material

The original letter from Dr. ROY JAMES BROWN, publisher of THE FREE AMERICAN, to the SECRET ARMY ORGANIZATION, San Diego, California.

File where original is located if not attached

170-37-A-154
157-1173-A

* INDIVIDUALS DESIGNATED BY AN ASTERISK (*) ONLY ATTENDED A MEETING AND DID NOT ACTIVELY PARTICIPATE. VIOLENCE OR REVOLUTIONARY ACTIVITIES WERE NOT DISCUSSED.

Information recorded on a card index by _____ on date _____

Remarks:

There is attached hereto a Xerox copy of a letter dated Sept. 15, 1972, at Christoval, Texas 76935, by one Dr. ROY JAMES BROWN, Publisher of THE FREE AMERICAN, addressed to SECRET ARMY ORGANIZATION, Box 5791, San Diego, California 92105.

Informant advised that he obtained the above letter from JERRY LYNN DAVIS of Lemon Grove, California during the month of October, 1972.

CLC:clc

- 2 - Dallas (RM)
- ② - San Diego (RM)
- 2 - Phoenix
 - 1 cc 157-1173 (SAO)
 - 1 cc 170-37-A

Block Stamp
The Free American
P. [unclear]

157-2815-286

SEARCHED <input checked="" type="checkbox"/>	INDEXED <input checked="" type="checkbox"/>
SERIALIZED <input checked="" type="checkbox"/>	FILED <input checked="" type="checkbox"/>
NOV - 2 1972	
FBI - SAN DIEGO	
<i>Harretson [initials]</i>	



The Free American

The Official News Report of The Brown Forum

Dr. Roy James Brown, P.A.E., N.I.A., F.A.S.P.
Director and Publisher



"Truth Will Prevail Where There Is Pain Taken To Bring It To Light" — George Washington

P.O. BOX 26

CRISTOVAL, TEXAS 76935

15 SEPTEMBER, 1972

Secret Army Organization
Box 5791
San Diego, Calif. 92105

Dear Sirs:

I saw one of your recruiting stickers and am writing to see if you are what I am looking for.

I have been fighting "Communism" in this country since 1947. Several organizations have had my support. I found them and their leaders to be fine dedicated patriots but due to very unfortunate circumstances none have been able to survive as active fighting groups.

I head the Patriot Militia of The Free American Group which has become very inactive for the past three years due to my efforts to amalgamate with larger stronger organizations.

Please send me any information that you might care to. I in return will send you whatever information you desire on me.

In this manner we can look each other over to see if a mutual benefit could be established in the fight to fight for a Free America.

You may know me as I have been very active over the years. I may know you but that remains to be seen when you contact me. I hope that you have "something on the ball" that will be what we need to fight America's enemies from within and otherwise.

I look forward to hearing from you.

For a Free America!

Roy Brown

11/1/72

AIRTEL

AIRMAIL - REGISTERED MAIL

TO: ACTING DIRECTOR, FBI (157-26763)

FROM: SAC, SAN DIEGO (157-1820) (P)

WILLIAM FRANCIS YAKOPEC
EM - SAO
(OO: San Diego)

Re San Diego teletype to the Bureau dated 10/25/72, and San Diego airtel to the Bureau dated 10/6/72.

Enclosed for the Bureau are five (5) copies of an LHM regarding captioned subject.

A copy of the enclosed LHM has been disseminated locally to the United States Secret Service because the Secret Army Organization (SAO) presents a potential for violence.

Two (2) copies of an FD-376 are attached to the Bureau copies.

San Diego is keeping this case open pending disposition of outstanding charges held against WILLIAM FRANCIS YAKOPEC for violating Sections 12305 and 12303 of the California Health and Safety Code, sections which charge him with Possession of Explosives and Possession OF A Destructive Device.

2-Bureau (Encls-5) (AM-RM)

3-San Diego
(2-157-1820)
(1-157-2815)

JLH:vw
(5) *vw*

W

Corrected *RD*

157-2815-285

SEARCHED _____ INDEXED _____
SERIALIZED *RD* FILED _____

SD 157-1820

Subject is not being recommended for
ADEX at this time because of his conviction, and
sentence of an indeterminate period.

San Diego, California
November 1, 1972

WILLIAM FRANCIS YAKOPEC

On October 2, 1972, WILLIAM FRANCIS YAKOPEC, an alleged member of the Secret Army Organization (SAO), was found guilty by Superior Court of the County of San Diego on charges of Igniting and Exploding A Destructive Device; Assault With Intent To Commit Murder; Simple Assault; Assault With A Deadly Weapon On A Police Officer; and Possession of Explosives Near A Habitation. The charge of Attempted Murder resulted from the bombing of the Guild Theatre, 3827 Fifth Avenue, San Diego, California, on June 19, 1972.

The Secret Army Organization (SAO) is an anticommunist, paramilitary organization formed in 1971 in San Diego, California. It intends to conduct intelligence-type operations and to offer training in urban guerrilla warfare to be used against "Left-Wing groups" and suspected enemies of the United States.

On October 24, 1972, LARRY WILSON, District Attorney's Office, advised that WILLIAM FRANCIS YAKOPEC was sentenced on October 24, 1972, to one year to life and remanded to custody. YAKOPEC has been found guilty of Igniting and Exploding A Destructive Device; Assault With A Deadly Weapon Upon A Police

DAJH:vlw (9)
JFW

157-2915-285

This document contains neither recommendations nor conclusions of the FBI. It is the property of the FBI and is loaned to your agency; it and its contents are not to be distributed outside your agency nor duplicated within.

WILLIAM FRANCIS YAKOPEC

Officer and Assault To Commit Murder; Simple Assault,
and Possession of Explosives Near A Habitation.

Before sentencing, WILLIAM FRANCIS YAKOPEC gave an impassioned confession before Judge CONYERS in Superior Court admitting his guilt in the bombing of the Guild Theatre and his having aided the Secret Army Organization.

LARRY WILSON, District Attorney's Office, stated the arrest and conviction of WILLIAM FRANCIS YAKOPEC was directly attributable to the information and testimony of HOWARD BARRY GODFREY.

HOWARD BARRY GODFREY, for a number of years, voluntarily furnished the FBI information regarding the identities and activities of extremist groups in the San Diego area. His information has been reliable and as an interested citizen, he volunteered his knowledge and services to local law enforcement agencies which culminated in his appearance and testimony before the San Diego County Grand Jury in June and July, 1972.

Date prepared

10/20/72

Date received

10/20/72

Received from (name or symbol number)

~~SD 2157-E (PROB)~~

Received by

ARTHUR J. HOOPER

Method of delivery (check appropriate blocks)

in person. by telephone by mail orally recording device written by Informant

If orally furnished and reduced to writing by Agent:
Date

Date of Report

10/13/72

Dictated _____ to _____

Date(s) of activity

10/18/72

Transcribed _____

Authenticated by Informant 10/13/72

Brief description of activity or material

INFORMATION VOLUNTARILY PROVIDED NSWP

PROPAGANDA IN BEHALF OF SAO MEMBERS

File where original is located if not attached

* INDIVIDUALS DESIGNATED BY AN ASTERISK (*) ONLY ATTENDED A MEETING AND DID NOT ACTIVELY PARTICIPATE. VIOLENCE OR REVOLUTIONARY ACTIVITIES WERE NOT DISCUSSED.

Information recorded on a card index by _____ on date _____

Remarks:

1-170-512A-19
1-157-23 (NSWP)
1-157-201 (GERALD LEE SMITH)
① 157-2815 (SAO)

157-2815
Block Stamp

SEARCHED _____ INDEXED _____
SERIALIZED _____ FILED _____
OCT 20 1972
FBI - SAN DIEGO
H.R. J. HOOPER

(The following is an open letter of protest to the SAN DIEGO POLICE DEPT., the EL CAJON POLICE DEPT., the SCHOOL, TOBACCO, & FIREARMS DIVISION of the U.S. TREASURY DEPT., and the SAN DIEGO COUNTY SHERIFF'S DEPT.)

Dear Sirs:

We, the undersigned, vigorously protest the arrests of William F. Yakopec, George M. Over, Sam Davis, and Mr. & Mrs. Richard J. Fleury—all of whom were arrested in connection with alleged "Secret Army Organization" activity.

Aside from the question of their direct guilt or innocence, there is the matter of the circumstances surrounding their arrests, the importance of which overshadows the question of culpability. We are referring to the gross imbalance of justice exhibited in excessive surveillance, harassment, and penalties for Rightist and White Racialist activists, as contrasted to the almost universal leniency granted the Radical Left.

We hear constantly of riots, Viet Cong flags being raised over U.S. cities and institutions; of lawlessness, murder, violence, conspiracy. In connection with these sordid pieces of news, we typically hear of token arrests (or no arrests), light sentences (if any), quittals, slaps on the wrist. In short, the Left-wing in this country, as in most countries, flagrantly breaks the law with little or no consequence to themselves.

The salient point is this: the Radical Left consistently breaks the law to advance their aims, and generally gets away with it—constituting a clear and present danger to the internal security of America. It is also apparent that the "authorities" have abdicated from their responsibilities to stop this threat, and have instead stooped to spying on Rightist and Racialist groups and individuals—the overwhelming majority of whom are law-abiding.

In this repressive and threatening atmosphere it is hardly surprising that patriotic Americans are sorely tempted to resort to violent means to preserve their liberties. From this simple observation we can draw the following conclusion: THE ALLEGED INCIDENTS WOULD HAVE TAKEN PLACE IF THE LAW-ENFORCEMENT AGENCIES HAD BEEN DOING THEIR JOBS. The fact that the agencies in question did not do their jobs in dealing with the Left meant that for the safety of us all someone else had to do it for them—the best way they knew how. And that "someone else", whoever they may be, should not be held culpable for what ultimately amounts to the "authorities'" dereliction of duty to stop treason, sedition, and subversion.

We consequently demand three things: the dismissal of all charges against the aforementioned suspects, the end of all surveillance of Rightist and White Racialist groups and individuals, and strict enforcement of the law against ALL leftist miscreants.

American Patriots! White Racialists! Don't let our FIGHTERS down. They fought for YOU, and now it's up to YOU to help them. When Communists and Radical Leftists are "busted" the entire liberal-Radical community puts itself on the line for them—which is why most go free. We've been letting our activists down, many are still languishing in jails and prisons across the country. Let's let these people know they're not alone. Secure as many signatures for these protest letters as you can, and send them to the agencies involved, or better yet to the newspapers, radio & TV stations. Let the Reds do the same, and more, for their people. CAN YOU DO ANY LESS?

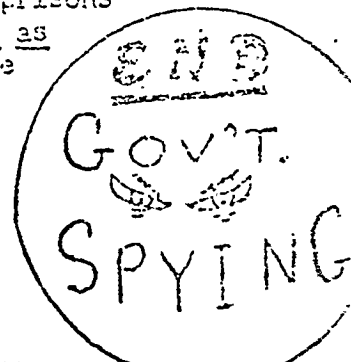

rt by Sandman

. October 18, 1972

/ECT: NSWPP propaganda in defense of SAO activities.

Enclosed with this report you will find a copy of some literature which demands, among other things, the release of all persons who were arrested in connection with activities of the Secret Army Organization. The author of this literature is Gerald L. Smith of the National Socialist White People's Party. This letter not only defends the actions of the SAO but also condemns most law enforcement agencies for their parts in apprehending SAO members. It also blames the actions of the SAO on the failure of the authorities to stop Leftist lawlessness. The leaflet pretty well speaks for itself so that's all I have to say on that matter.

Date dictated

10/15/72

Date received

10/17/72

Received from (name or symbol number)

INFORMATION
~~SD 2157-B (PROB)~~

Received by

ARTHUR J. HOOPER

Method of delivery (check appropriate blocks)

in person

by telephone

by mail

orally

recording device

written by Informant

If orally furnished and reduced to writing by Agent:

Date

Dictated _____ to _____

Transcribed _____

Authenticated by Informant 10/15/72

Date of Report

10/15/72

Date(s) of activity

10/15/72

Brief description of activity or material

INFORMATION VOLUNTARILY PROVIDED RE NSWPP;
SAO; GERALD LEE SMITH; GEORGE HOOVER; DENNIS
LOSO; STANLEY MCDADAE; JERRY LYNN DAVIS

File where original is located if not attached

* INDIVIDUALS DESIGNATED BY AN ASTERISK (*) ONLY ATTENDED A MEETING AND DID NOT ACTIVELY PARTICIPATE. VIOLENCE OR REVOLUTIONARY ACTIVITIES WERE NOT DISCUSSED.

Information recorded on a card index by _____ on date _____

Remarks:

1-170-512 A-16
1-157-23 (NSWPP)
1-157-200 (GERALD LEE SMITH)
① 1-157-2815 (SECRET ARMY ORGANIZATION)
1-157-3017 (GEORGE HOOVER)
1-157-2933 STANLEY MCDADAE (MCDADAE)
1-157-3487 (JERRY LYNN DAVIS) 157-3001
1-157-3487 (DENNIS LOSO)
2-157- (WESLEY ROUNDS) (OSA)
1-157- (DEAD) (AL MCDONALD) (MCDONALD)

INDEX TO 157-28 (NSWPP)

Block Stamp

157-2815-273
SEARCHED B INDEXED _____
SERIALIZED _____ FILED _____
OCT 19 1972
FBI - SAN DIEGO
H. J. [Signature]

SUBJECTS: Activities ● Dennis Loso--Joint acti● es of NSWPP & SAO.

Enclosed you will find a newspaper clipping and a photograph which describes the opening of the John Schmitz for President headquarters in Escondido. As described in the clipping, Dennis Loso is the second man from the right. It figured that Loso would be involved in this because he was a great Schmitz supporter long before this presidential race. The other three men I do not know. However, there are some of his hunting and political associates of which I could tell you something. One is Wesley Rounds. This man has been worked on for a long time by Loso. Politically, he has always tended toward the right, but Loso has succeeded in bringing him much farther along toward National Socialism. Rounds is manager of the Californian Motel. It is located in Escondido at the northeast corner of Hwy 395 and Washington Avenue. Rounds' exact age I do not know but I would guess him to be somewhere in his 40s. Sometime back Loso took Rounds to his first William Gale service at Oneira Hall in San Diego. Rounds seemed impressed with Gale. Wes is married.

Another man who periodically visits Loso is Al McDonald. Al is 40 years old and is a friendly, congenial type of person. He is single and spends much of his time in Montana "living the good life." Whenever he runs low on money, he comes down to Escondido and works for Dennis for a while. He claims that he managed to live on just \$3,000 last year. McDonald also spends a fair amount of time living in Montague, California. This town is located in Siskiyou County near the Oregon border. McDonald's parents also live there. They very much disapprove of his Nazi sympathies. On one occasion, his Mother found a large swastika in his cabin while he wasn't there. She threw it in his wood burning stove and would have burned it except that she couldn't find any matches. His most recent visit to Escondido was in July and August at which time he gave the swastika flag to Loso for safe keeping. Loso allowed McDonald to stay rent free in one of his unoccupied apartments.

I learned from Gerald Smith recently that as long as one year ago, there were joint target practice sessions between members of the NSWPP and the SAO. The site of these little excursions was the Gunsmoke Ranch. Gerald says the place is virtually a stronghold of the Minutemen. Participants in the target shooting sessions most frequently were Gerald Smith, Ray Wilson, Mrs. Ray Wilson, Stanley McDade, Jerry Lynn Davis and George M. Hoover. Gerald says Hoover is a crack shot with either a rifle or pistol. Gerald himself qualified as an expert rifle shot in the service.

What's all for now. Take care and see you later. Sincerely,

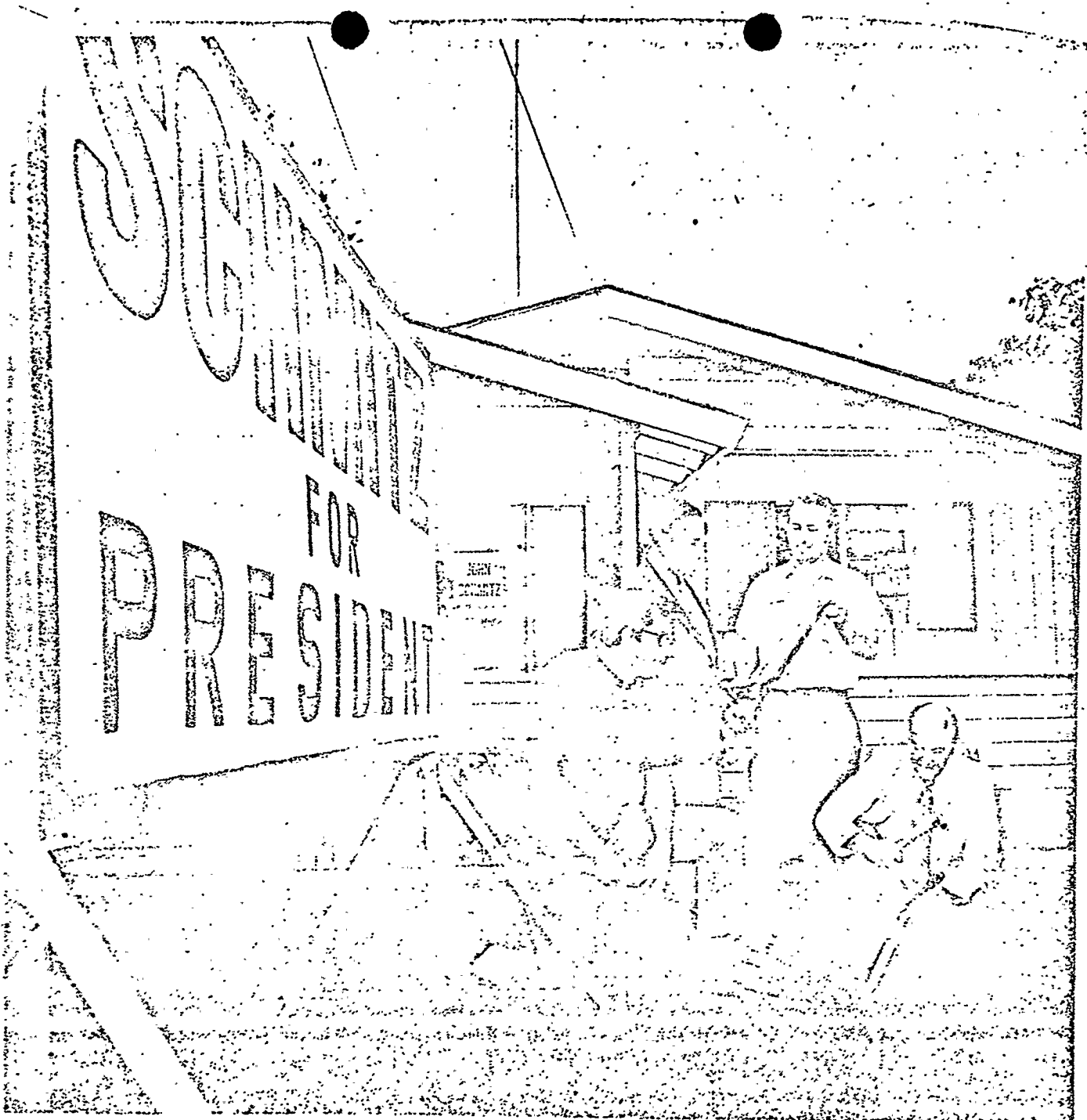

Staff Photo by Dan Rios

10-10-72
T-A, ESCONDIDO

Office opened by Schmitz backers

Working for the John Schmitz presidential campaign in the Escondido area are (from left) Bob Freeman, Dale Talbot, Dennis Loso and Jack Swigart, as they erect a sign

at local Schmitz headquarters, 137 W. Washington Ave. The office will be open from 10 a.m. to 3 p.m. and 5 p.m. to 8 p.m. Monday through Saturday.



FBI SUMMARY OF EXTREMIST ACTIVITIES

October 18, 1972

WEEK OF OCTOBER 9 - 15, 1972

ARMS REPORTED AT NEWTON FACTION PANTHER OFFICE



Despite the Black Panther Party Newton Faction current line of *work within the system*, the Winston-Salem, North Carolina, headquarters of this group has rifles and pistols stored there and other weapons are kept in nearby houses. This chapter recently received orders from Panther headquarters in California to defend local headquarters at all costs and the local group was criticized for allowing police to search its office last year. The Winston-Salem Chapter, one of the most active Newton Faction Units, as noted in the October 4 Summary, is also discussing a possible firearms training program. In addition, a member of the group is reported to be planning a surveillance of the local office of the FBI. (C)

AFRO-AMERICAN LIBERATION ARMY CLAIMS POLICE CAR BOMBING

An unmarked police cruiser was destroyed by a heavy explosive blast October 7 in Los Angeles. Shortly after the bombing a reporter received an anonymous call claiming credit for the bombing for the Afro-American Liberation Army. This is a name used by the military arm of the Cleaver Faction of the Black Panther Party and is the same as the Black Liberation Army. This was the 28th attack on police vehicles and installations; police equipment has been subject to 13 bombings, one attempted bombing, 9 fire bombings, and 5 arsons in the U. S. this year. (U)

BLACK WORKERS CONGRESS MEETING ATTRACTS MARXISTS

Delegates to the International Black Workers Congress (IBWC) meeting held September 2-3 in Lincoln Heights, Ohio, included Black Panthers, "citizens" of the separatist Republic of New Africa.

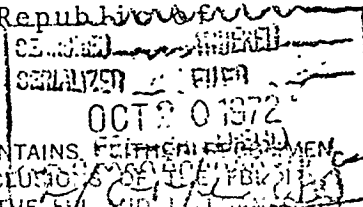

CLASSIFIED BY ACTING DIRECTOR, FBI
EXEMPT FROM GENERAL DECLASSIFICATION
SCHEDULE OF EXECUTIVE ORDER 11652
EXEMPTION CATEGORY 2
AUTOMATICALLY DECLASSIFIED ON INDEFINITE

THIS DOCUMENT CONTAINS FEWER RECOMMENDATIONS NOR CONCLUSIONS OF THE FBI. IT IS THE PROPERTY OF THE FBI AND IS LOANED TO YOUR AGENCY; IT AND ITS CONTENTS ARE NOT TO BE DISTRIBUTED OUTSIDE YOUR AGENCY NOR DUPLICATED WITHIN YOUR AGENCY.

CONFIDENTIAL

not pg 2

, members of the Puerto Rican Socialist Party and
 Puerto Rican Revolutionary Workers Organization (formerly
 King Lords Party); One speaker was a former member of
 Communist Party, USA, and another, an IBWC leader from
 California, advocated formation of cadres to advance
 workers' understanding of Marxism-Leninism. The IBWC, which
 advocates a nationwide work stoppage, did not achieve its
 goal of 500 to 5,000 persons at this conference (August 23
 Summary), but did attract 450 delegates from 13 states and
 the District of Columbia. (U)

BOMB FACTORY LOCATED IN CLEVELAND



After the African Peoples Party was evicted from
 its headquarters for nonpayment of rent; the
 landlord found bomb-making materials and ammunition
 in the building. Materials for pipe bombs,
 practice hand grenades, .45 caliber ammunition,
 and oxygen breathing apparatus were seized in
 the office. This group advocates an independent
 nation for *African captives in America* and demands the
 territory of 5 southern states. The African Peoples Party
 branch in Philadelphia claimed long-time revolutionary
 Max Stanford as its leader (May 24 Summary) and called
 its *Black Guard...the most powerful people's liberatio
 army.* (C)

SECRET ARMY MEMBER CONVICTED, OTHERS CHARGED

A member of the vigilante Secret Army Organization (SAO) was
 convicted in San Diego October 2 on bombing charges and 2
 others with SAO connections were indicted for perjury
 October 10 as a result of the first trial. The bombing was
 not the first violence attributable to the SAO; the white
 hate-type group has also been linked to an attack on a
 "radical" professor. The August 2 summary noted that large
 amounts of SAO weapons and explosives were seized in July.
 (U)

MUSLIMS BUY SECOND NEWSPAPER

The Nation of Islam (NOI) Muslim group has just purchased a
 weekly community newspaper published in the Chatham area of
 Chicago for the past several years. The all-black, separatist
 group is now printing and publishing *This Is Chatham*, but
 as yet has not used the newspaper to publicize its teachings.
 Advertisements of Muslim business enterprises are being
 carried, however, and NOI members are distributing the newspaper,
 along with the regular Muslim publication, *Muhammed Speaks.* (U)

UNITED STATES GOVERNMENT

Memorandum

TO : SAC, SAN DIEGO (157-2815) (P)

DATE: 10/19/72

FROM : SA ARTHUR J. HOOPER

SUBJECT: SECRET ARMY ORGANIZATION
EM - SAO

On 10/19/72 Special Agent JOHN A. KEEFE, United States Secret Service, San Diego, California, requested information regarding known members of the Secret Army Organization (SAO) in conjunction with the protective responsibilities of the United States Secret Service. In conjunction with Special Agent KEEFE's request for identifying information concerning known Secret Army Organization members, Special Agent ARTHUR J. HOOPER provided all pertinent background information on the following known Secret Army Organization members in the San Diego, California, area.

- ROBERT MAYER, JR.
- JERRY LYNN DAVIS
- THOMAS LEE FORREST
- STANLEY MC DADE
- JAMES EVAN POTO
- GENEVIEVE FLEURY
- PAUL RUPPLINGER
- BETTIE ELLEN CARTER
- HOWARD FRANCIS CLARK
- WILLIAM FRANCIS YAKOPEC
- RICHARD FLEURY
- CALVIN FOX
- GEORGE HOOVER

2-157-2815

AJH:vkw
(2) jfw

157-2815-262

SEARCHED	INDEXED
SERIALIZED	FILED
OCT 19 1972	
FBI-SAN DIEGO	



Date 10/11/72

To: Director

Att.: _____ FILE SD 157-2815
SD 157-3001

SAC SAN DIEGO Title _____

ASAC _____

Supv. _____

Agent _____

SE _____

IC _____

CC _____ RE: _____

Steno _____

Clerk _____ Rotor #: _____

ACTION DESIRED

Acknowledge

Open Case

Assign _____ Reassign _____

Prepare lead cards

Bring file

Prepare tickler

Call me

Return assignment card

Correct

Return file

Deadline _____

Search and return

Deadline passed

See me

Delinquent

Serial # _____

Discontinue

Post Recharge Return

Expedite

Send to _____

File

Submit new charge out

For information

Submit report by _____

Handle

Type

Initial & return

Leads need attention

Return with explanation or notation as to action taken.

Enclosed for SD, two ccs FD-306.

(RM) (Enc. 2) SD

SAC PAUL J. MOHR PJM/PS

PHOENIX

See reverse side

Office _____

Date printed

10/ 9/ 72

received

10/9/72

Received from (name or symbol number)

~~INFORMANT~~
~~PX 783-E~~

Received by

SA CLARENCE L. GRANDALL

Method of delivery (check appropriate blocks)

in person by telephone by mail orally recording device written by Informant

If orally furnished and reduced to writing by Agent:

Date

Dictated _____ to _____

Transcribed _____

Authenticated by Informant _____

Date of Report

10/9/72

Date(s) of activity

Brief description of activity or material

~~INDIVIDUAL~~
~~JERRY LEVIN DAVIS~~ of the SAO visits in
~~City of San Diego~~
~~Phoenix, Arizona~~

File where original is located if not attached

170-37-A

* INDIVIDUALS DESIGNATED BY AN ASTERISK (*) ONLY ATTENDED A MEETING AND DID NOT ACTIVELY PARTICIPATE. VIOLENCE OR REVOLUTIONARY ACTIVITIES WERE NOT DISCUSSED.

Information recorded on a card index by _____ on date _____

Remarks:

~~INDIVIDUAL~~
~~San Diego~~ Informant advised that ~~JERRY LEVIN DAVIS~~ visited in ~~Phoenix, Arizona~~ ^{CITY} on ~~10/9/72~~ where he conferred with elements of the SAO relative to the future of the organization. ~~DAVIS~~ was of the opinion that the Secret Army Organization is now dead as far as San Diego is concerned, but that a coterie of possibly twenty-five individuals in Los Angeles may carry on under the label of the SAO. ~~DAVIS~~ was of the opinion that what is left of the SAO, because of court proceedings against the group in San Diego, will will retrench in terms of activity. All mail drops of the SAO in San Diego have been discontinued, according to ~~DAVIS~~.
~~INDIVIDUAL~~

CAREFUL PARAPHRASING OF THE ABOVE INFORMATION MUST OCCUR, IF UTILIZED IN REPORT FORM, IN ORDER TO PROTECT INFORMANT.

CLC/

- 2 - Phoenix 1 - 170-37-A
- 1 - 157-1173 (SAO)
- ② - San Diego
- 1 cc 157-2315
- 1 cc 157-3001
- 1 - Los Angeles (info)

Block Stamp

157-1173-263

SEARCHED	INDEXED
SERIALIZED	FILED
FEB - SAN DIEGO	

Memorandum

TO : SAC, SAN DIEGO (157-3224)

FROM : SAC, LOS ANGELES (157-6836) (P)

SUBJECT: NATIONAL SOCIALIST AMERICAN
WORKERS PARTY (NSAWP)
EM - WHITE HATE GROUP
OO: LA

DATE: 8/31/72

Re Phoenix airtel to Bureau, 8/10/72.

Enclosed is one copy of reairtel and one copy of the LHM referred to therein and dated 8/10/72.

As copies of enclosures were not previously furnished to San Diego, copies are enclosed. As noted in the LHM; ~~PX-933-E~~ advised on 7/12/72 that according to Scott Winchester, National Commander in July, 1972, he had not talked to Secret Army Organization (SAO) people in over a month.

Above is furnished for your information.

② San Diego (Encl. 2) (RM)
(1- 157-2815) (SAO)
2 Los Angeles
(1- 157-7318) (SAO)
ANC
(4)



5010-106

Buy U.S. Savings Bonds Regularly on the Payroll Savings Plan

157-2815-205

157-6836

SEARCHED	INDEXED
SERIALIZED	FILED
SEP 2 1972	
FBI-SAN DIEGO	

UNITED STATES GOVERNMENT

Memorandum

TO : SAC, SAN DIEGO (157-2815)

DATE: 8/29/72

FROM : SAC, SEATTLE (157-1830) (RUC)

SUBJECT: SECRET ARMY ORGANIZATION
EXTREMIST MATTERS

Re Seattle letter to Bureau, 7/11/72.

The following sources have been contacted, none of whom have been able to furnish any information as to the existence of the above mentioned organization.

<u>Source</u>	<u>Date Contacted</u>	<u>Agent</u>
SE-845-E	6/19/72	SA LOUIS M. HARRIS, JR.
SE-1100-E	6/22/72	SA LOUIS M. HARRIS, JR.
CSSE-1093-E	8/4/72	SA SIDNEY E. RUBIN
CSSE-1101-E	8/7/72	SA SIDNEY E. RUBIN
CSSE-1093-E	8/2/72	SA CHARLES R. ST. JOHN

The above sources have been instructed to immediately advise this office upon receipt of any information concerning this organization.

Whereas no pertinent information has been determined concerning the existence of this organization, this case being placed in a RUC status in this division. For the information of San Diego, Seattle continuing investigation on SY ANDERSON to obtain background data as he has been reputed to be leader of this organization in Seattle.

- 2 - San Diego (REG)
- 1 - Seattle
- SER:set
- (3)

157-2815-204

SEARCHED	INDEXED
SERIALIZED	FILED
SEP 2 1972	
FBI-SAN DIEGO	
<i>Moore</i>	



Buy U.S. Savings Bonds Regularly on the Payroll Savings Plan

File-Serial Charge Out
FD-5 (Rev. 6-17-70)

GPO : 1970 OF-400-586

File 157-2815 _____
Class. Case No. Last Serial Date

Pending Closed

Serial No. _____ Description of Serial _____ Date Charged _____

Serial # 203

Skipped

Employee _____ Date _____
RECHARGE
To _____ From _____

Initials of Clerk { _____
_____ } Date { _____
_____ }

Do Not Remove _____
Employee Date Charged

_____ Location

NR004 WA CODE

12:09 AM 9-2-72 LMG

NITEL 9-1-72 LRS

TO SAN DIEGO (157-2815)

FROM ACTING DIRECTOR (157-23577) 2P

SECRET ARMY ORGANIZATION (SAO), EXTREMIST MATTERS.

RESDETEL AUGUST TWENTY-NINE LAST.

KEVIN T. MARONEY, DEPUTY ASSISTANT ATTORNEY GENERAL, INTERNAL SECURITY DIVISION, DEPARTMENT OF JUSTICE, ON SEPTEMBER ONE INSTANT ADVISED AUTHORITY GRANTED FOR FORMER SA STEVEN L. CHRISTENSEN TO TESTIFY IN ANSWER TO THE PROSECUTION'S QUESTIONS DURING THE TRIAL OF GEORGE MITCHELL HOOVER, SUPERIOR COURT, SAN DIEGO COUNTY, SAN DIEGO, CALIFORNIA, AS WERE FURNISHED THE BUREAU BY TELECOPIER ON AUGUST TWENTY-NINE LAST. ASSISTANT UNITED STATES ATTORNEY (AUSA) PHILLIP H. FILSINGER, SAN DIEGO, WILL BE ADVISED SEPTEMBER SEVEN NEXT BY MR. MARONEY THAT TESTIMONY OF CHRISTENSEN IS TO BE LIMITED TO ANSWERING ABOVE-MENTIONED QUESTIONS OF WHICH AUSA IS AWARE. A CONFERENCE IS TO BE HELD BY AUSA FILSINGER WITH FORMER SA CHRISTENSEN PRIOR TO HIS APPEARANCE AS A WITNESS TO INSURE HE UNDERSTANDS LIMITATIONS OF HIS TESTIMONY AND THAT IN ACCORDANCE WITH CODE OF

END PAGE ONE

Info was furnished telephonically to AUSA Filfinger on 9/1 and again on 9/5 on 9/5/72. Dir Filfinger advised that he was not in possession of the questions and answers which the Dept had authorized for Christensen. A copy of the Q & A was personally delivered to Mr. F. by SA [unclear] on 9/5/72.

157-2815-202

SEARCHED	INDEXED
SERIALIZED	FILED
SEP 10 1972	
FBI - SAN DIEGO	
<i>Petersen</i>	

PAGE TWO

FEDERAL REGULATIONS, TITLE EIGHTEEN, SECTION SIXTEEN POINT TWELVE, DATA OBTAINED WHILE IN PERFORMANCE OF DUTIES AS SA CANNOT BE DISCLOSED UNLESS APPROVED BY THE ATTORNEY GENERAL. ADDITIONAL DATA REQUIRED IS TO BE FURNISHED THE DEPARTMENT IN ORDER THAT CONSIDERATION CAN BE GIVEN AS TO WHETHER SUCH IS TO BE DISCLOSED. AUSA IS TO BE PRESENT DURING TESTIMONY BY CHRISTENSEN IN ORDER TO PROTECT GOVERNMENT'S INTEREST.

MR. MARONEY REQUESTED AUSA BE ADVISED BY SAN DIEGO OFFICE OF THE ABOVE AND INDICATED IT WOULD BE DESIRABLE FOR KNOWLEDGEABLE SAS OF SAN DIEGO OFFICE TO BE PRESENT DURING CONFERENCE WITH CHRISTENSEN AND AUSA.

END

HOLD

San Diego, California
August 30, 1972

Mr. Steven L. Christensen
Post Office Box Number 2
Kanosh, Utah

Dear Steve:

In reply to your letter of August 23rd, I can certainly understand your reluctance to testify for the reasons mentioned. However, as you are well aware, there are few willing witnesses in any criminal prosecution and the nature of the subjects involved dictate they be brought to the bar of justice.

I have been advised of your communications with Mr. John A. Hewicker, II, Assistant District Attorney, San Diego County, in this matter, and hope that as a result thereof you will arrive at a mutually agreeable course of action.

I would like to mention that any proposed trial testimony regarding information developed as a result of your official duties as a Special Agent of the FBI must be identified and furnished to the Department of Justice in order that consideration can be given as to whether information is to be disclosed by you. SA Earl M. Petersen will coordinate this matter and will assist you in any way possible.

With hopes that the ends of justice will be served with the minimum of inconvenience to you, and that you and your family are adjusting to your new environment, I am,

Sincerely,



REX I. SHRODER
Special Agent in Charge

1 - Addressee
2 - San Diego (157-2815)
(1 - 157-3017 HOOVER)
AJM:ajt
(3)

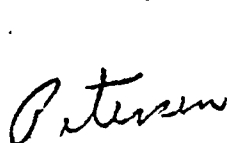
157-2815-198

SEARCHED..... INDEXED.....
SERIALIZED..... FILED.....

San Diego, California
August 30, 1972

Mr. Steven L. Christensen
Post Office Box Number 2
Kanosh, Utah

Dear Steve:

In reply to your letter of August 23rd, I can certainly understand your reluctance to testify for the reasons mentioned. However, as you are well aware, there are few willing witnesses in any criminal prosecution and the nature of the subjects involved dictate they be brought to the bar of justice.

I have been advised of your communications with Mr. John A. Hewicker, II, Assistant District Attorney, San Diego County, in this matter, and hope that as a result thereof you will arrive at a mutually agreeable course of action.

I would like to mention that any proposed trial testimony regarding information developed as a result of your official duties as a Special Agent of the FBI must be identified and furnished to the Department of Justice in order that consideration can be given as to whether information is to be disclosed by you. SA Earl M. Petersen will coordinate this matter and will assist you in any way possible.

With hopes that the ends of justice will be served with the minimum of inconvenience to you, and that you and your family are adjusting to your new environment, I am,

Sincerely,



REX I. SHRODER
Special Agent in Charge

- 1 - Addressee
- (2) - San Diego (157-2815)
(1 - 157-3017 HOOVER)
- AJM:ajt
- (3) 

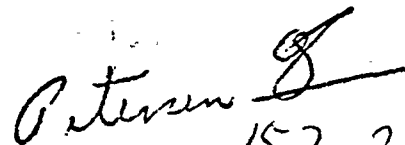

157-2815-192

SEARCHED..... INDEXED.....
SERIALIZED..... FILED.....

Kanosh, Utah
August 23, 1972

Rex I. Shroder
Special Agent in Charge
Federal Bureau of Investigation
San Diego, California 92103

Dear Mr. Shroder:

In connection with the investigation and prosecution of the shooting of Paula Tharp, for which Geroge M. Hoover has been indicted, I have received correspondence from Mr. Hewicker of the San Diego County District Attorney's Office asking whether I would be willing to testify in this matter. The purpose of this testimony would be to substantiate the reliability of Howard Godfrey as an informant and to provide information as to the custody of the weapon involved. I have indicated to Mr. Hewicker that I would not be unwilling to furnish such testimony but would be somewhat reluctant due to my present circumstances. It would appear to me that the interests of the Bureau and the District Attorney's Office, as well as myself, would be better served if this information was furnished by someone still connected with the FBI. Godfrey's reliability should be a matter of record to which Earl Petersen could easily testify. Furthermore Mr. Petersen has some first-hand knowlege as to the location of the weapon, and, because of the nature of the incident, I imagine my testimony in this respect would need as much substantiating as Godfrey's.

Another decided disadvantage for me would be the disclosure of my present whereabouts to individuals such as representatives of the "Door", to whom you made reference in your letter of the Fifteenth. I do not desire to be located or contacted by these or similar people. However, if this should occur, I intend to state merely that I left the Bureau on the advice of my personal physician, which would have been an actuality within a period of a few weeks or months anyway.

I would certainly appreciate it if such a course of action as I have mentioned could be made feasible.

Sincerely,



Steven L. Christensen
P. O. Box #2
Kanosh, Utah 84637

157-2815-19

SEARCHED	INDEXED
SERIALIZED	FILED
AUG 30 1972	

UNITED STATES GOVERNMENT

Memorandum

TO : SAC, San Diego (157-2815)

DATE: 8/29/72

FROM : SA EARL M. PETERSEN

SUBJECT: SECRET ARMY ORGANIZATION
EX-CEMIST MATTERS

Attached for the file is a copy of questions to be asked of former SA STEVEN L. CHRISTENSEN at the trial of GEORGE MITCHELL HOOVER on 9/7/72. One copy is being placed in the Hoover file, 157-3017.

The hand written original set of questions received from ~~Assistant~~ Deputy District Attorney John A. Hewicker II, San Diego County has been placed in the 1A file of 157-3017.

A copy of the attached was forwarded to the Bureau by teleconier on 8/29/72.

EMP:emr
(2)

[Handwritten signature] 1-157-3017

157-2815-191

SEARCHED	INDEXED
SERIALIZED	FILED
AUG 29 1972	
FBI—SAN DIEGO	



CC'd - W/H - P/L
10:15 AM
8-29-72 jw

On August 28, 1972, JOHN A. HEWICKER, II, Deputy District Attorney, San Diego County, made available to the FBI the following list of questions to be asked of former SA STEVEN L. CHRISTEN on direct examination by the prosecution during the trial of GEORGE MITCHELL HOOVER beginning September 7, 1972:

1. Name ?
2. Formerly employed as a Special Agent for the Federal Bureau of Investigation.
3. For how many years ?
4. Where was your last duty station ?
5. How long were you assigned to the San Diego Office ?
6. During the time that you were assigned to the San Diego Office did you become acquainted with an individual known as HOWARD BARRY GODFREY ?
7. When approximately did you meet GODFREY ?
8. What were the nature of your duties as an FBI Agent at the time you met HOWARD GODFREY ?
9. How did you become acquainted with GODFREY ?
10. Was there a particular purpose in your becoming acquainted with HOWARD GODFREY ?
11. What purpose -- ?
12. Was there an alternate agent designated as a contact for HOWARD GODFREY ?
13. Who ?
14. Was GODFREY a paid informant of the FBI ?
15. Did the FBI in any way finance the operations of the SAO ?
16. How often did GODFREY contact you as an informant ?

17. How were these contacts made?

18. During what period of time to your knowledge, did Mr. GODFREY act as an informant for the FBI?

19. What type of information did GODFREY furnish you during the period that he was assigned to you as an informant?

20. Do you recall the reported occurrence of the shooting of PAULA THARP in San Diego in January, 1972, at the home of PETER BOHMER?

21. Did Mr. GODFREY make any contact with you regarding the alleged identity of the person who shot PAULA THARP?

22. When?

23. How was contact made?

24. Did Mr. GODFREY at any time furnish you with a weapon which was allegedly the weapon used in the shooting of PAULA THARP?

25. When?

26. Who present?

27. Where were you when the weapon was presented to you by Mr. GODFREY?

28. What type of weapon was it?

29. What did you do with the weapon at the time it was presented to you by Godfrey?

30. Did you notify any local investigative agency of the information furnished to you by GODFREY, relative to the identity of the person who reportedly shot PAULA THARP?

31. What agency?

32. Who did you confide in at that agency?

33. Did you furnish the San Diego Police Department with the weapon at the time you furnished this information regarding the shooting?

34. Why not?

35. Did you tell anyone at the San Diego Police Department that you had possession of the suspect weapon?

36. How long did you have possession of the suspect weapon?

37. Was the weapon ultimately removed from your possession and turned over to local authorities?

38. Approximately when--?

39. Identify if possible this weapon.

Memorandum

TO : SAC, San Diego (157-2815)

FROM : SA EARL M. PETERSEN

SUBJECT: SECRET ARMY ORGANIZATION
EM

DATE: 8/29/72

Attached for the file is a list of questions and answers for writer's testimony 9/6/72 in the trial of WILLIAM FRANCIS YAKOPEC.

Deputy District Attorney RICHARD HUFFMAN, San Diego County, made available the list of questions.

A copy of the questions is being placed in the YAKOPEC file, 157-1820.

This list of questions and answers were made available to the Bureau by nitel this date for authority for writer to testify.

1 - 157-1820
EMP:emp

(2)

157-2815-190

SEARCHED	INDEXED
SERIALIZED	FILED
AUG 29 1972	
FBI-SAN DIEGO	

[Handwritten signature]



5010-108

Buy U.S. Savings Bonds Regularly on the Payroll Savings Plan

The following questions will be asked of SA EARL M. PETERSEN on September 6, 1972, by the prosecution as direct testimony in the trial of WILLIAM FRANCIS YAKOPEC:

1. Question: How long have you been assigned as a Special Agent in the San Diego Office of the FBI?
Answer: Since July, 1967.
2. Question: Do you know a person by the name of HOWARD B. GODFREY?
Answer: Yes.
3. Question: How long have you known him?
Answer: About two and one half years.
4. Question: Has he ever performed any services for the FBI?
Answer: Yes.
5. Question: In what capacity?
Answer: He furnished information to the FBI concerning matters of interest to the FBI.
6. Question: For what period of time?
Answer: Since 1967.
7. Question: Was he a paid informant?
Answer: Yes he was.
8. Question: Was he assigned to infiltrate any particular group or groups?
Answer: Yes he was.
9. Question: What particular groups was he assigned to infiltrate?
Answer: The Minutemen and the Secret Army Organization.
10. Question: How long did you work with Mr. GODFREY in his capacity as an informant?
Answer: Mr. Godfrey has contacted me on occasion for about two years.
11. Question: Were you the primary agent responsible for Mr. GODFREY?

Answer: Only since July 10, 1972.

12. Question: Who were the primary agents?

Answer: Special Agent JORDAN NAYLOR and former Special Agent STEVEN CHRISTENSEN.

13. Question: What was your responsibility for Mr. GODFREY?

Answer: I maintained contact with him when CHRISTENSEN was not available.

14. Question: Did Mr. GODFREY report regularly to the FBI concerning the activities of the Secret Army Organization?

Answer: Yes he did.

15. Question: How often did he report?

Answer: On practically a daily basis.

16. Question: Were you present when Mr. GODFREY was first made available as a witness to California Authorities?

Answer: Yes.

17. Question: When did this take place?

Answer: June 26, 1972.

UNITED STATES GOVERNMENT

Memorandum

TO : SAC, SAN DIEGO (157-2815)

FROM : SA LAWRENCE F. WIRICK

SUBJECT: SECRET ARMY ORGANIZATION (SAO)
EXTREMIST MATTERS

DATE: 8/23/72

Re San Diego airtel and LHM to Bureau 8/18/72.

Referenced communication has been filed in 157-2815-172. This communication contains information regarding the activities and arrests of the subjects of this case. Due to the volume of the communication, copies were not designated for each individual file but the communication should be consulted when writing subsequent reports or letters.

- ② - 157-2815
- 1 - 157-1820 (WILLIAM FRANCIS YAKOPEC)
 - 1 - 157-3017 (GEORGE MITCHELL HOOVER)
 - 1 - 157-3290 (RICHARD FLEURY)
 - 1 - 157-3289 (GENEVIEVE FLEURY)
 - 1 - 157-3001 (JERRY LYNN DAVIS)
 - 1 - 157-2931 (ROBERT MAYER, JR.)
 - 1 - 157-2546 (HOWARD FRANCIS CLARK)
 - 1 - 157-3388 (VAHL BOYLE)
 - 1 - 157-2177 (THOMAS LEE FORREST)

LFW:ejt
(11)

157-2815-175

SEARCHED	INDEXED
SERIALIZED	FILED
AUG 23 1972	
FBI—SAN DIEGO	
<i>W</i>	



5010-108

Buy U.S. Savings Bonds Regularly on the Payroll Savings Plan

3211 Fifth Avenue
Post Office Box 3636
San Diego, California 92103
August 23, 1972

Special Agent In Charge
18th District
Office of Special Investigations
United States Air Force
4325 Pacific Highway
San Diego, California 92106

Dear Sir:

This is in reference to your request that information regarding the Secret Army Organization, an anti-Communist paramilitary organization in the San Diego, California, area, be furnished to your office.

An extensive investigation conducted by this office has failed to demonstrate any propensity for violence directed at the Laguna Air Force Station or any other military installation in the San Diego, California, area by the Secret Army Organization. Inasmuch as investigation has failed to disclose any evidence that Office of Special Investigations has an interest in or responsibility for investigating, it is not felt, at this time, that further dissemination regarding this matter would benefit or be of use to your office.

Please be assured that the Federal Bureau of Investigation will continue its investigative efforts in this matter, and will promptly advise and keep your office current of any developments on part of the Secret Army Organization that have a bearing on or relate to your investigative interests.

1-Addressee
1-San Diego (157-2815)

AJH:vlw (2)
Hw

Very truly yours,

RS
REX I. SHRODER
Special Agent In Charge

157-2815-174

SEARCHED.....INDEXED.....
SERIALIZED.....FILED.....

TO: SAC, PHOENIX 7-1173

Date prep

8/14/72

Date received
8/14/72

Received from (name or symbol number)
~~INFO-1173~~
~~PX-783-E~~

Received by
SA Clarence L. Crandall

Method of delivery (check appropriate blocks)

in person by telephone by mail orally recording device written by Informant

If orally furnished and reduced to writing by Agent:
Date

Date of Report

8/14/72

Dictated _____ to _____

Date(s) of activity

8/6/72

Transcribed _____

Authenticated by Informant _____

Brief description of activity or material

Re arrest of SAO members in the San

Diego area 6/26/72.

File where original is located if not attached

170-37-A

* INDIVIDUALS DESIGNATED BY AN ASTERISK (*) ONLY ATTENDED A MEETING AND DID NOT ACTIVELY PARTICIPATE. VIOLENCE OR REVOLUTIONARY ACTIVITIES WERE NOT DISCUSSED.

Information recorded on a card index by _____ on date _____

Remarks:

Source advised that he has learned indirectly that JERRY LYNN DAVIS, who has been in jail in California since July 5, 1972, was released from jail during the first week in August, 1972, and is now living % PAULA HELTON, 3618 Nereis, La Mesa, California, telephone 714-466-5074. Source advised that DAVIS is the leader of the group known in the San Diego area as the SECRET ARMY ORGANIZATION, and that he and three other members of the group were arrested by the San Diego Police Department on or about June 26, 1972. The charges against them were based on the possession of explosives and illegal weapons.

Source advised that the above-mentioned arrest was also based on a shooting wherein the gun of one HOWARD GODFREY was used. The latter is also a member of the SAO and an alleged "double-agent" type informant for the F.B.I. Source stated that it is the intention of the SAO to embarrass the F.B.I. in some unexplained manner when the above-mentioned SAO subjects come to trial.

- 3 - Phoenix
 - 1 cc 157-1173 (SAO)
 - 1 cc 170-37-A
 - 1 cc 157-620 (NM)

*1 cc to 170-286A
1 cc to 157-3001 (Davis)*

- ③ - San Diego (157-2815)

Block Stamp

157-2815-120

SEARCHED _____	INDEXED _____
SERIALIZED _____	FILED _____
AUG 16 1972	
FBI - SAN DIEGO	
<i>Harvey</i>	

W. L. ...

UNITED STATES GOVERNMENT

Memorandum

TO : SAC (157-2815)

DATE: 8/8/72

FROM : Danny Morris

SUBJECT: SECRET ARMY ORGANIZATION

This date SA ROY REYSA, OSI, San Diego, requested information concerning the Secret Army Organization stating that the Laguna Air Force Base had requested this information.

He was advised that their office would be furnished current data on the SAO as soon as current report is completed.

Furnish OSI with latest report and or copy of LHM when it is available.

1 - San Diego

DM:dm
(1)

157-2815-165

SEARCHED _____	INDEXED _____
SERIALIZED _____	FILED _____
AUG - 8 1972	
FBI - SAN DIEGO	
<i>[Signature]</i> HES	



Buy U.S. Savings Bonds Regularly on the Payroll Savings Plan

UNITED STATES GOVERNMENT

Memorandum

TO : SAC, SAN DIEGO (157-1820)(P)

DATE: 7/29/72

FROM : SA JOE A. WEATHERALL, JR.

SUBJECT: WILLIAM FRANCIS YACOPEC
EM-SAO
OO: SD

A Confidential Source Throughout

On 7/20/72, FRED HETTER, Attorney (PROTECT AT REQUEST) provided information to SA JOE A. WEATHERALL, JR., regarding a 7/17/72, conversation by HETTER and YACOPEC, HETTER's client. YACOPEC told HETTER that he is on the periphery of the SAO and was not allowed to join the group. YACOPEC has heard from "members" of the SAO which he did not mean that they (the SAO members) are planning to kill one or two dozen "long hairs" in San Diego in September or October. YACOPEC stated that he cannot tell authorities of this matter as his wife will be killed within 24 hours.

YACOPEC told source that the Police Department haven't arrested anyone who is significant in the organization.

HETTER made further comments not related to his conversation with YACOPEC. He stated that he believed VIC WALTON, Attorney, to be an associate of the SAO. Most of YACOPEC's associates are armed with handguns at all times. HETTER commented that HOWARD GODFREY had testified before the Grand Jury, without consulting his attorney and considered this unusual.

HETTER stated he provided this information in order to possibly prevent innocent persons from being harmed.

- 2 - 157-1820 (YACOPEC)
- 1 - 157-2315 (SECRET ARMY ORGANIZATION)

JAW:mjz
(3) *MB*

157-2315-145

SEARCHED	INDEXED
SERIALIZED	FILED
JUL 31 1972	
FBI - SAN DIEGO	
<i>Maple</i>	



SD 157-1820

SA EARL M. PETERSEN was advised 7/20/72.

The above information regarding a possible SAO plan was carefully paraphrased to protect the source of dissemination to the following agencies by SA JOE A. WEATHERALL, JR.:

<u>Date</u>	<u>Person Contacted</u>
7/20/72	REUBEN BRANDON Detective, SDPD
7/20/72	NANCY BYRD Deputy Sheriff Intelligence SDSO
7/21/72	JIM BERRIAN Special Agent CBI

Date prepared

7/6/72

Informant

Date received

7-5-72

Received from (name or symbol number)

PX 783-E

Received by

SA CLARENCE L. CRANDALL

Method of delivery (check appropriate blocks)

in person by telephone by mail orally recording device written by Informant

If orally furnished and reduced to writing by Agent:

Date

Dictated _____ to _____

Transcribed _____

Authenticated by Informant _____

Date of Report

Date(s) of activity

JUNE 1972

Brief description of activity or material

Undated communications from SAM, aka JERRY

DAVIS at San Diego, Calif. re SAO.

File where original is located if not attached

Originals returned to source

* INDIVIDUALS DESIGNATED BY AN ASTERISK (*) ONLY ATTENDED A MEETING AND DID NOT ACTIVELY PARTICIPATE. VIOLENCE OR REVOLUTIONARY ACTIVITIES WERE NOT DISCUSSED.

Information recorded on a card index by _____ on date _____

Remarks:

Informant furnished the printed material which is attached hereto in Xerox form.

ANY UTILIZATION OF THIS INFORMATION IN FORM SUITABLE FOR DISSEMINATION MUST BE PARAPHRASED ADEQUATELY TO PROTECT THE INFORMANT.

- 2 - Phoenix
(lcc 170-37-A)
(lcc 157-1173) SAO

- ② - San Diego
(lcc 157-2815) SAO ✓
(lcc 157-3001) DAVIS

157-2815-131

Block Stamp

SEARCHED _____	INDEXED _____
SERIALIZED _____	FILED _____
FBI - PHOENIX	

[Handwritten signature]

IDENTIFIED INFORMANT

~~Informant~~
Comrade Wells,

In case you have not heard yet we have been up to our ears in cops over here. They pulled a midnight raid and arrested four persons. They are holding two of our guys on \$50,000 dollars bond each. All told they have them charged with six attempted murder charges, plus/and other mickey mouse things. This has to be one of the biggest frame-ups in history of right wing groups.

I will send you copys of newspaper clips in a few days. I am going to see some lawyers tomorrow. Keep your powder dry.

SAM

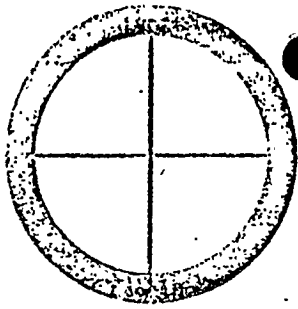

SECRET ARMY ORGANIZATION

UNDERGROUND BULLETIN

GENERAL HEADQUARTERS

JUNE 1972

" The people never give up their liberties but under some delusion ". Edmund Burke

Fellow members,

At a recent meeting of the SAO General Staff a very important problem was discussed and the decision to issue a new Organizational Directive made. The problem is that of new members who join our organization and then immediately become totally inactive.

Typically these new members submit a well qualified application form together with their membership fee. Unfortunately, after being accepted as provisional members they never pay a month's dues or send in any report forms. It would really help us to know why some of these people have acted in this way. Did our organization turn out to be something different than they expected? Did they expect a fancy uniform and rifle to be handed to them on a silver platter? Or did they suddenly become afraid to stick their neck out?

Whatever the reasons, it isn't fair to our good members to waste time and money on those who do nothing to help or support the organization. Therefore, effective immediately, the following rules shall apply to such cases as mentioned above.

1. If, three months after submitting an application to the SAO and being accepted as a provisional member, the new member has not begun the basic correspondence training submitted monthly report forms, paid monthly dues, or provided a reasonable excuse for not having done the above, their file shall be turned over to our Intelligence Section for special attention.

2. If, after six months, the member in question doesn't respond they shall be dropped from our rolls and their names shall be circulated to all members as a potential security risk.

We don't mean to imply that a member can't resign from the Secret Army Organization. However, we do require that a member notify us of their intent and reasons for doing so. If this new Organizational Directive applies to any member in particular let him take notice and govern himself accordingly. GENERAL STAFF - SECRET ARMY ORGANIZATION

HOW TO PREPARE GUNS FOR STORAGE & BURYING

Although cosmoline can be purchased in many surplus stores, it may be more practical to make your own from the following directions. One advantage to making your own preparation is that it is much easier to apply while it is in a warm state.

Heat non-bleached petroleum jelly (ember-vaseline) in a small pan or can. Add 30 or 40 weight motor oil to obtain the proper consistency. Using an inexpensive throw-away paint brush as an applicator, brush the warm solution over the weapon. While the solution is still warm it can also be poured into those hard-to-get-at-areas.

One large jar of petroleum jelly and approximately one-half quart of motor oil is sufficient to prepare several weapons.

When the solution has cooled it will set and form a protective coating over the weapon which should then be wrapped in sheet plastic (available in most hardware or paint stores) or in a G. I. plastic gun case (available in most surplus stores). Wrap well and seal with black electrical or plastic tape. It is also wise to enclose a small sack of silicagel crystals to keep the moisture out. These crystals can be purchased at any industrial chemical house or most appliance stores will give them away as they come with cartons of appliances when shipped and they usually have an abundance on supply.

Long guns which cannot be easily torn down can be stored in surplus rocket type boxes readily available in most surplus stores. Try to obtain aluminum or stainless steel containers since they will not tend to rust when buried. 20mm ammunition cans are adequate and a convenient size container for burying smaller weapons and other items. They should be well sealed. The cans should be wrapped in plastic to prevent rust.

Buried containers should have at least one and a half feet of earth over them. One should be careful also in selecting an area to bury material. Areas that could be flooded during even the most unusual weather conditions should be avoided.

Buried containers should be in such a position that they can be found easily and quickly without the use of maps. This can be done by correlation between two or more specific points that will remain in tact, such as trees, large rocks, etc. To assist your memory, paces should be marked off by using the day, month, and year of your birth or that of some family member which you can easily remember.

Another suggestion would be for burying containers along or near roadways which are marked with numbered signs indicating the footage of road per county. These signs are permanent, but it must be remembered that the state has a 500 foot right away on most roads which means the brush may be cleared or the existing road might be widened.

All material which is buried should be checked within three to six weeks for settling or sinking of the ground.

GENERAL RULES OF GUERRILLA WARFARE

1. The first rule of guerrilla warfare is to dispense with any rule or set of rules which results in routine or predictable activity. Any time the enemy commander can anticipate what the guerrilla band will do next, he can then lay a trap by which his superiority of numbers and equipment may be brought to bear upon them with devastating effect.

2. Military action by guerrilla bands cannot achieve maximum effect unless intelligence and security capabilities are developed to an equal degree of perfection, principally through the cooperation of friendly non-combatants.

3. Propaganda warfare is one of the guerrillas most effective weapons. It must be waged continuously to demoralize the enemy, enlist support of the civilian population and to justify the existence and actions of the guerrilla bands.

4. Each member of the underground movement must be rendered immune to the enemy's propaganda by continuous counter-propaganda. They must realize that the enemy is certain to spread lies about their leaders, to try and break the bands up by encouraging petty jealousies and dissensions, to make them feel their fight is hopeless, to encourage them to get on the winning side, to offer mercy and rewards to those who voluntarily surrender. Most of all enemy propaganda will be aimed as destroying the individual organization member's faith in the honesty, capability and true motives of other members of the underground movement.

5. Surprise is the main element of successful guerrilla warfare. No matter how vigilant the enemy may be there will be times your band can take him by surprise. Perhaps he is tired, perhaps sleeping, perhaps he is in an area where he feels so completely safe that he lets down his guard-- that's when you hit him.

6. Any guerrilla that wants to keep on living must constantly remind himself that war is not a sporting proposition-- never give the communists an even break.

7. Generally speaking guerrillas must work in small bands. From five to fifteen is usual but even here it's best not to get into a rut. If the enemy commander in your area knows you always work in small groups he can then divide his available anti-guerrilla forces into groups of 15 to 25 and thus cover more ground than if he had to maintain groups of two or three hundred to make certain his forces would always outnumber any guerrilla band they happened upon.

8. The guerrilla leader must always keep his thinking one step ahead of the enemys. Here are some examples:

A staff car filled with enemy officers is travelling along the highway when the driver sees something ahead. As they draw closer they see it is a man, apparently dead, sprawled in the middle of the highway. The car stops and the enemy officers get out to investigate. Suddenly the "corpse" rolls over and cuts them down with a machine gun.

This little trick might work several times but eventually the enemy will figure it out. The driver of a truck full of enemy troops sees a "corpse" lying in the road. Quickly he stops the truck. The troops pile out of the truck and riddle the "corpse" with bullets. Too late they discover its only a dummy made of old clothes and straw. They are caught in a murderous cross-fire between guerrillas hidden along both sides of the road. Most are killed but one lives long enough to tell what happened.

A few days later another truck of troops sees a "corpse" lying in the middle of the highway. The driver has been forewarned so he knows better than to stop. Instead he steps on the gas, runs over the dummy as he speeds on around the next curve in the road-- perhaps into a hidden land-mine. Or perhaps into a chain stretched between two trees. Or perhaps onto a part of the highway that has been covered with fresh oil which sends the truck skidding over an embankment.

What will the next truck full of troops do? What can you figure out so you will still be thinking one step ahead of the enemy?

9. Generally speaking the guerrilla band must avoid superior forces. When attacked by a superior force the guerrillas must quickly retreat or disperse. When the enemy stops, they may return to harass him-- or perhaps they won't. When the enemy is exhausted they may attack-- but again they may not. When the enemy retreats the guerrillas may give chase-- but only if they can be very sure they are not being led into a trap.

10. Guerrillas must always fight at a time and place of their own choosing-- never at a time or place of the enemy's choosing.

11. Before any raid on enemy troops or installations the guerrilla leader must obtain complete and accurate intelligence on the number of the enemy on hand, the number near enough to be called on for assistance, amount and type of enemy armament, location of sentries, scouts or protective patrols and all other information that will effect the planning or conduct of the raid.

12. All raids against the enemy must be exactly planned and carefully rehearsed. It is often desirable to draw a miniature copy of the enemy installation so that all members of the raiding party can play out their respective duties several times to make sure they do not forget or become confused in the heat of battle.

13. Everything that could possibly go wrong must be anticipated and alternate plans made to cope with any eventuality.

14. Guerrillas should strike a violent lightning blow that leaves the enemy stunned at least long enough for them to make a safe retreat.

15. In no case must the guerrillas allow themselves to be drawn into a long pitched battle with enemy troops.

16. So long as friendly forces of the conventional military are able to retain their offensive potential it is expedient for guerrilla forces to coordinate their activities with such friendly troops.

17. Guerrilla bands must always move in secret-- their whereabouts must always be hidden from the civilian population as well as from enemy troops.

18. When possible always attack the enemy at places which are distant from centers of population as this will reduce the possibility of his making reprisals against friendly civilians.

19. If a lone enemy soldier is way-laid in the city or suburbs it is best to carry his body away where it can be buried and the grave camouflaged so his commander will not know whether he has been killed or has deserted. Take his uniform and hide it carefully where it can be later retrieved. It might come in handy.

20. The guerrillas must always operate in their home territory where they have intimate knowledge of their surroundings. If driven from their own territory by a superior enemy force they should return as soon as they safely can, provided that their main hide-out has not been discovered and there is no chance of an enemy ambush.

21. Guerrillas must make every effort to stay friendly with any civilian population in their territory as the civilians may be their best source of food, other supplies, or valuable information about nearby enemy forces.

22. It is almost essential that the guerrilla band have at least one secure hide-out where they can rest up, store their supplies and care for their wounded. This hide-out may be in some large forest or mountainous area but such is not always necessary. During World War II one Russian guerrilla band had their headquarters in a storm sewer. Another band headquartered in the basement of a hospital in one of the smaller towns. Another operated from an abandoned coal mine.

23. The guerrilla band should have one or more alternate hide-outs and be ready to move quickly and quietly to another prepared location in case their main headquarters is discovered. To preserve maximum security the location of these alternate hide-outs should be known to the least possible number of their own band.

24. To operate successfully over long periods of time the guerrilla band must have plenty of space in which to maneuver-- preferably a large enough area that the enemy is incapable of covering all of it with anti-guerrilla forces at one time.

25. Guerrilla activity is most suitably conducted in mountains, swamp and other types of terrain that are inaccessible to tanks, large guns and mechanized forces but with proper strategy at least some guerrilla activity can be suited to almost any type area-- even large cities. Furthermore, due to the widespread use of light weight weapons such as the bazooka and recoilless rifle it must be expected that mountains will provide somewhat less protection to guerrillas in future wars than they have in the past. Therefore it is essential that underground activity be directed against the enemy under every possible condition and over the widest possible area so as to prevent his concentrating his forces for a complete "mop-up" operation in any one district.

26. Guerrilla forces cannot ordinarily afford to take prisoners. If you are lucky enough to capture a high-ranking officer or party official he may be held for ransom or as a hostage to guarantee against extreme brutality by the enemy or reprisals by the enemy against the civilian population. With extreme caution he may be traded for guerrillas held prisoner by the enemy.

Most commonly any captured enemy must be shot. If prisoners are taken they must be kept in chains and closely guarded day and night. If one were to escape he would certainly lead the enemy back to your hideout.

27. Due to their superior forces, the enemy may make several mistakes and still fight effectively. For the guerrilla band a single mistake may lead to complete annihilation. Therefore every activity must be conducted with extreme caution and complete secrecy.

28. Guerrillas must be extremely tidy housekeepers. Garbage thrown out around camp may attract birds which in turn may alert the enemy. A tin can, carelessly tossed aside may catch the sun just right to be seen by a scouting airplane. While on the march a broken branch or a thoughtlessly dropped match cover may give your presence away to the enemy who could radio ahead to set up an ambush.

29. Each member of the band must be constantly alert that his own action does not give away the guerrilla position to the enemy. In remote areas the smell of smoke may carry for many miles. Even cigarette smoke can give away the sentries position to a quietly approaching enemy scout. On a dark night the glow of a cigarette can be seen for 300 yards. With a good pair of binoculars it can be seen for a mile.

30. A single careless or obstinate member must not be allowed to endanger the lives of the other members of the band.

31. Guerrilla forces cannot afford defeat and are poorly equipped to care for casualties. Therefore, action against the enemy must be taken only under such conditions as insure maximum opportunity for success.

32. Before any action is taken against the enemy one or more clear paths of retreat must be assured.

33. If a guerrilla is killed in action other members of the band should try to take his body with them as they retreat. It will become very demoralizing to the enemy if he is constantly aware of his own casualties but sees no evidence of guerrilla losses.

34. If a member of the guerrilla band is wounded then the other members must carry him away at all costs-- even at the risk of their own lives. This is essential both for the morale of the band but to make certain the fallen guerrilla is not tortured into revealing the identity of his friends and the location of their camp.

35. Guerrilla forces seldom attempt to occupy territory in the usual sense. Instead they seek to dominate the territory by continuous raids, ambushes and harassment of enemy troops to such an extent that continued occupation by enemy forces is no longer worth the price they must pay.

36. Success in guerrilla warfare depends largely on superior mobility.

Transport and movement are therefore of great importance to the guerrilla band. So long as the civilian population is allowed to use their automobiles the guerrillas can (with forged identity cards) do likewise. If the civilian population is rigidly controlled or largely enslaved then the guerrillas must depend on other methods of transportation.

Bands that must move on foot are limited in the distance over which they can operate. Possible targets for sabotage must be within two or three nights march. Even then the guerrillas are apt to be badly fatigued before they go into action and they will have trouble getting away without being discovered.

Suppose that a guerrilla scout reports that a poorly guarded supply column is camped 30 miles away. The guerrilla band may need these supplies desperately but if they must travel by foot the enemy will likely have moved on before they can get there. These are serious problems for which each band must find solutions depending on their own conditions and territory.

37. Close cooperation between different bands is seldom required and may be undesirable. Therefore it is more important that communication between bands be secure than that it be fast.

38. Each guerrilla band is responsible for its own actions and bears the pain of its own mistakes without drawing other bands into any calamity that may befall it.

39. When anti-guerrilla activity becomes very intense, large bands should disperse into a number of small bands that can hide easier, move faster and can filter through enemy lines with less risk of detection.

40. There is a big difference between sabotage and wanton destruction. All guerrilla activities must be conducted so as to cause minimal damage to private property.

41. Hit-or-miss sabotage is not nearly as effective as coordinated sabotage that strikes systematically at some few essential industries of activities vital to the enemy at that particular time.

42. Targets for raids and sabotage must be carefully selected to achieve maximum damage to the enemy with least risk to the guerrilla band. If the enemy has an abundance of guns but is low on ammunition then burning a warehouse full of guns will not count for much whereas burning a warehouse full of ammunition would be a vital blow.

43. Each military action against the enemy must be planned in such a manner that the amount of ammunition and supplies captured are at least enough to replenish the amount expended in that action.

44. Both offensive and defensive guerrilla activity is vitally dependent upon accurate knowledge of the enemy's strength, location, movements and so far as possible his intentions which is usually best obtained first hand by guerrilla scouts.

45. In the event that troops have settled down in the guerrilla area for a long and routine occupation, efforts should be made to determine whether or not they are completely loyal to the foreign ideology before antagonizing a possible potential ally.

46. The guerrilla must be continuously imagining himself in the shoes of his enemy. He must get to know how the enemy is likely to react in any given situation. He must be able to guess what the enemy commander will expect his band to do next. In this way he can often anticipate what the enemy will do. By then acting in some totally unexpected manner he can continuously catch the enemy in a series of embarrassing situations.

47. Guerrilla forces must remain widely dispersed throughout the entire area of enemy occupation. They must never accumulate in large numbers in a given area that the enemy can surround and eventually starve them out or gradually close in on them.

48. Guerrilla forces must be always alert to possible anti-guerrilla action that may be taken against them and constantly prepared to take suitable evasive action.

49. The guerrilla bands most essential function is to guarantee its own continuation. The very existence of the guerrilla band requires the enemy to guard against them and in so doing they are drained of manpower, supplies and equipment which the enemy forces might be needing badly in some other area.

50. Clear-cut victory is seldom possible either with or against guerrilla warfare-- the side that holds out longest will be the ultimate winner.

Please fill out and return to your assigned mail drop as quickly as possible. If you have not yet been assigned a regular mail drop, Mail to: P. O. Box 5791, San Diego, California 92105.

CODE NAME OR IDENTIFICATION NUMBER: _____

ADDRESS: _____ ZIP CODE: _____
(Only if changed from last month)

BASIC CORRESPONDENCE TRAINING PROGRAM: (Enclose \$3.00 for each program)

Intelligence Security Propaganda Recruiting

Special Note: Each program must be ordered only upon completion of the prior program. Enclose payment when ordering each program.

SECRET ARMY ORGANIZATION MATERIALS:

S. A. O. Stickers (50 for \$1.00) S. A. O. Leaflets (50 for \$1.00)

Other Materials Needed: _____
(Recruiting forms, Histories, Etc.)

S. A. O. DUES FOR _____ CONTRIBUTION TO S. A. O. _____

S. A. O. DUES FOR _____ MATERIALS _____

TOTAL ENCLOSED _____

DESCRIBE BRIEFLY YOUR ACTIVITIES PERTAINING TO THE ORGANIZATION DURING THE PAST MONTH:

SECRET RECIPES

HOME-MADE EXPEDIENTS

CHERRY BOMB

12 powders from cherry bombs
1 fuse from cherry bomb
one snuff can 2" high and 1" across
about 50 bebes

After powder and bebes are in can, put lid on. Take ice pick, punch hole in top of lid. Slip fuse in. Then cover can completely with airplane glue around the base of the fuse to hold in place better when thrown.

PLASTIC

Potassium Chlorate
Petroleum Jelly (Vaseline)
A round wooden stick or rolling pin

Spread the Potassium Chlorate thinly on a hard surface. Roll the round stick (rolling pin) over the crystals to crush them into a very fine powder (until it looks like face powder). Take 9 parts of the powdered Potassium Chlorate and one part of vaseline, and knead them together until a uniform paste is obtained. Detonate with a blasting cap or with a .30 caliber fused blank.

BLACK POWDER

Potassium Nitrate - 25 parts
Charcoal - 3 parts
Sulphur - 2 parts

Dissolve the Potassium Nitrate in an equal amount of water. Pulverize the charcoal and sulphur, and add the Potassium Nitrate solution to obtain a thoroughly wet paste. Allow to dry.

FAST BURNING FUSE

Twist soft cotten string into three strands. Moisten black powder to form a paste and rub the paste into the twisted string. Burns 30 to 40 inches per minute.

SLOW BURNING FUSE

Dissolve one part of Potassium Nitrate or Potassium Chlorate and one part of sugar (granulated) in two parts of hot water. Soak the string in this solution. Twist the string into three strands and allow to dry. Burns about 2 inches per minute.

FUSES

Fuses can be made by soaking course paper in a solution of gun powder and acetone (nail polish remover) overnight, then drying. Cut strips and twist together. Also, by coating a cotton string with a sticky substance, then dipping into gunpowder, coating all surfaces. A time delay fuse that can be used without a match is made as follows: Make a small pile of potassium permanganate and make a small pile of it on the ground, making a hole in the center of it. Next pour in the hole about an equal amount of straight glycerine. A flash will occur in about one minute. This method is best used when gun powder has to be used as a fuse... or for starting fires.

PACKAGE BOMB

mouse trap
electrical wire
box or package

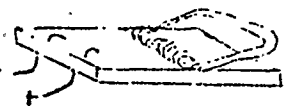
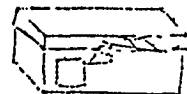

The mouse trap is the trigger. When the box is opened, the trap will close and contact on two electrical wires.

JELLIED GASOLINE

Pour the contents of one bottle (1 pint 3 oz.) of Dynamo concentrated liquid laundry detergent into a bucket or large mouthed can of about two to five gallon size. Fill the detergent bottle twice, shaking well to rinse it out with gasoline (any grade) and add it to the detergent. You will now have about 3 1/2 pints (57 oz) of material in the bucket. The detergent will be at the bottom and the gasoline on the top. Stir this rapidly with a wooden or wire paddle so as to mix in as much air as possible. Soon the mixture will take on the appearance of soft vasoline.

Now add in a gallon of gasoline and stir again until the mixture thickens. At this point, transfer the mixture to clean containers. No return type beer and soda bottles are ideal. For chemical land mines, use two gallon oil cans. The container should be filled approximately one third full of the mixture. Finish filling the container with gasoline leaving a little air space at the top. Place your finger or hand over the opening and shake well until the gasoline and mixture amalgamate. You can verify this by looking at the finger or hand occasionally to see if a film of jellied gasoline about an eighth of an inch thick clings to it. When proper consistency is reached, the bottles may be capped or corked. Cans should have tight fitting lids screwed on. This may be stored up to two weeks. Tie a rag around the neck of each bottle being careful not to leave the ends of the rag too long or too loose.

If necessary, this mixture can be "cut" 50% with gasoline or other petroleum product. The tendency to "cling" will suffer slightly, but consistency can be maintained by pouring off the excess gasoline whenever the detergent refuses to "take" any more.

To use, saturate the rag with gasoline or the mixture from the bottle. Keep the flammable material off of your person and clothing. Light the rag with match or cigarette lighter and immediately serve. Throw hard against a solid object such as masonry, concrete, or metal. In using the mixture in a chemical land mine, wrap three or four wraps of primacord around a two gallon can and tie the primacord under the can around a pound of explosive. This may be exploded either electrically or by a percussion such as a booby trap device or anti-personnel fuse. Do not contact wires to the blasting machine until after you have carefully removed all traces of your work and camouflaged the position. Never use any plastic article in contact with the above mixture.

ARMOUR PIERCING BULLETS

Reloaders can drop a 25 caliber steel ball bearing into a .30 caliber bullet mould and thus have an armour piercing bullet. It is also a duplex bullet as the ball bearing will keep going after the lead has stopped.

SHRAPNEL MINE

Length of stove pipe
nuts, bolts, buck shot, etc.
wood
dynamite
fuse

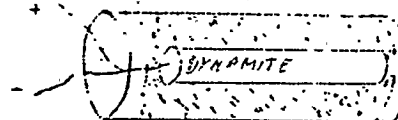

Block both ends of the stove pipe with wood after the stick of dynamite has been placed in the center. and the nuts, bolts, and other shrapnel material has been placed around the dynamite. Hang from a tree.

NOTES:

Date prepared

6/21/72

Informant

Date received

5/19/72

Received from (name or symbol number)

PX 933 E

Received by

SA Robert Schachner

Method of delivery (check appropriate blocks)

in person

by telephone

by mail

orally

recording device

written by Informant

If orally furnished and reduced to writing by Agent:

Date

Dictated

5/24/72 to IMB

Transcribed

5/29/72

Authenticated
by Informant

6/20/72

Date of Report

5/19/72

Date(s) of activity

5/72

Brief description of activity or material

SAD activity

File where original is located if not attached

170-270A-45

* INDIVIDUALS DESIGNATED BY AN ASTERISK (*) ONLY ATTENDED A MEETING AND DID NOT ACTIVELY PARTICIPATE.
VIOLENCE OR REVOLUTIONARY ACTIVITIES WERE NOT DISCUSSED.

Information recorded on a card index by _____ on date _____.

Remarks:

1-SAN DIEGO (157-2815) (RM)

QJM/MB

1-157-1173

1-157-1101

Block Stamp

157-2815-122

SEARCHED _____ INDEXED _____

SERIALIZED _____ FILED _____

JUL 2 1972

Hooper JH

Phoenix, Arizona
May 19, 1972

Information was obtained that Captain STAN WILLIAMS' check sent to the Secret Army Organization, San Diego, California, for payment of membership fees and dues, has been cashed and returned. Photostat of the check is attached hereto. It is noted check is endorsed, "Secret Army Organization, Sam Collins".

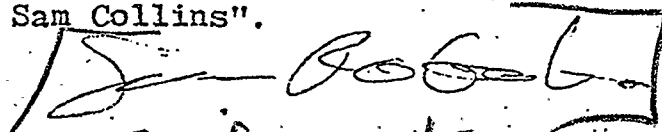
Informant

GWB Great Western
SAVINGS & TRUST



SCOTTSDALE OFFICE SCOTTSDALE, ARIZONA	DATE 3-15-70	91-314 1221
PAY TO THE ORDER OF <i>State of Arizona Dept. of Transportation</i>		
<i>fourty one and 00/100</i>		DOLLARS
<i>J. L. Williams</i>		
⑆1221⑆0314⑆ 9263⑆0500⑆		⑆0000004100⑆

*Secret Army Organization
Sam Collins*

001

PAY TO THE ORDER OF
EL CAJON VALLEY BRANCH
FIRST NATIONAL BANK
OF SAN DIEGO
FOR DEPOSIT ONLY

PAY TO THE ORDER OF
PAY ANY DEPOSIT TO THE G.
SOUTHERN CALIFORNIA
SAN DIEGO, CALIFORNIA

0016231

APR 3 1953
APR 3 1953

Date prepared

6/2/72

Informant

Date received

6/2/72

Received from (name or symbol number)

PX 783-E

Received by

SA CLARENCE L. CRANDALL

Method of delivery (check appropriate blocks)

in person by telephone by mail orally recording device written by Informant

If orally furnished and reduced to writing by Agent:
Date

Date of Report

Dictated _____ to _____

Date(s) of activity

Transcribed _____

Authenticated
by Informant _____

May 1972

Brief description of activity or material

Undated communications from SAM, namely,

JERRY DAVIS, San Diego, California,

File where original is located if not attached

concerning the SECRET ARMY ORGANIZATION

Originals returned to sou

* INDIVIDUALS DESIGNATED BY AN ASTERISK (*) ONLY ATTENDED A MEETING AND DID NOT ACTIVELY PARTICIPATE. VIOLENCE OR REVOLUTIONARY ACTIVITIES WERE NOT DISCUSSED.

Information recorded on a card index by _____ on date _____

Remarks:

Informant furnished the printed material which is attached hereto in Xerox form.

(ANY UTILIZATION OF THIS INFORMATION IN BUREAU REPORTS OR LEMs MUST BE PARAPHRASED ADEQUATELY TO PROTECT THE INFORMANT.)

- 2 - Phoenix
(lcc 170-37-A)
(lcc 157-1173) SAO
- ② - San Diego
(lcc 157-2815) SAO
(lcc 157-3001) DAVIS

Block Stamp

157-2815-113

SEARCHED _____	INDEXED _____
SERIALIZED _____	FILED _____
JUN 7 1972	
FBI - SAN DIEGO	

Christensen

We granted the interview with the newspaper women I wrote you about. It should be out in a week or so, will send you a copy when its printed. We really put on a show for this girl, the secret contact, meeting place, radio communications, etc. The whole secret agent bit. During the interview she told us that the police had been out to see her after the first article. The San Diego Police wanted to know who she had talked too (we mailed the information for the first story to her). Later she had a visit from the feds asking her if she would infiltrate our organization for them. They must be getting hard up for information when they have to go out and try to recruit people. This girl might be alright, but we are not going to trust her anyway. Its getting where I can count the people I trust on one hand and still have four fingers left.

Enclosed are three more letters for you, two wrong addresses, and one hate letter. Just so you will not think that you are the only one who gets these letters, I have enclosed one we received a few days ago. If the literature we send out gets these types (religious nuts and love creeps) so upset, then we must be on the right track.

SAM

Sorry about the delay in mailing you the May Bulletins, we just did not have the funds to pay for the printing until now. If nothing goes wrong we will be able to print-up the Security Training Program and your Mail Drop Transfer Letter this coming weekend. Hope to have the funds available for the Special Bulletin the following weekend.

I have enclosed a copy of the first part of the newspaper interview we gave. Will send you the other articles as they are printed. The way we understand it is that it will be a three piece article. The first one is not too bad. We have been receiving articles from other papers in the area too, but they have all been of the smear type.

On the subject of bulletins; when would you be able to write another one, and what subject would you be covering. Also would like for you to write the foremat (one or two pages) for some of the bulletins. We have been trying to keep the bulletins between 10 to 12 pages long. The only original bulletin we have put-out so far is the one you wrote on lock picking. I am fairly good at stealing material and rewriting it, but have trouble writing anything original.

Would like to set-up another meeting with you in the near future. There are some things we need to talk over with you that we cannot put in a letter. Let me know when you will have some time off and we will try to make some arrangements.

SAM

The shit hit the fan here this week again. We put out a Special Bulletin containing information about some of the San Diego City officials. The fuzz was out to see me two days after we mailed it out. They told me that the city had assigned two detectives on full time duty to keep an eye on SAO activities. The left fired bombed one of their own cars and tried to blame it own us, plus one of the city councilmen received a threatening phone call. The detectives told me that one high ranking left winger had call the police and demanded they assign him policemen to protect him.

We have been making some real good headway in setting up new groups in California. Some of the new people we are getting are working out real well, others are the hanger-on types. We are having a little trouble with some DePugh types up in Los Angeles. They don't like the idea of us organizing up there. If they start any trouble we will give them more than they are looking for, you can bet on that.

We should have the May Underground Bulletin ready to mail out to you by the first of the month. We are reprinting the Communications Bulletin. Rewrote it to fit our group. If we have the money I will try to print up both of the letters at the same time.

Sorry to here about you being out of work again, no how it is trying to make ends meet. I can only draw eight unemployment checks then I will have to go back to work. Sure wish some fat cat would finance a few of us to work full time on organization activities. Guess there is no danger of that thou.

SAM

Informant

Date prepared

3/21/72

Date received

3/21/72

Received from (name or symbol number)

PX 783-E

Received by

SA CLARENCE L. GRANDALL

Method of delivery (check appropriate blocks)

in person by telephone by mail orally recording device written by Informant

If orally furnished and reduced to writing by Agent:

Date

Dictated _____ to _____

Transcribed _____

Authenticated by Informant _____

Date of Report

Date(s) of activity

current

Brief description of activity or material

See below

File where original is located if not attached

Orig. returned to source

* INDIVIDUALS DESIGNATED BY AN ASTERISK (*) ONLY ATTENDED A MEETING AND DID NOT ACTIVELY PARTICIPATE. VIOLENCE OR REVOLUTIONARY ACTIVITIES WERE NOT DISCUSSED.

Information recorded on a card index by _____ on date _____

Remarks:

Source advised that information has come into his possession in the form of two undated letters in photocopy form addressed to "71501" from "71401". Copies of these letters, which pertain to security measures being taken by an organization known as SECRET ARMY ORGANIZATION, are attached hereto. Source has also determined that the code number 71501 is assigned to one EV MOORE in Phoenix, and that the code number 71401 is assigned to one SAM DAVIS in San Diego by the SAO.

- 2 - Phoenix
 - (1 - 170-37-A)
 - (1 - 157-1173)
- ② - San Diego
 - (1 - SAO) 157-2815
 - (1 - Sam Davis)

157-2815-112

Block Stamp

SEARCHED _____	INDEXED _____
SERIALIZED _____	FILED _____
JUN 5 - 1972	
FBI - SAN DIEGO	
<i>Christensen</i>	

To: 7I50I

The March Underground Bulletin should be in the mail to you by 14th at the latest. Will send you 25 copies of it, if you need more write. Will send you the Review Questions for the book Guerrilla at the same time. Also will send you a few more copies of the book. I have set up a front to buy books and am trying to order a lot of the Guerrilla book.

Am writing to the printing house that handled War of Wits, to see if maybe they could locate a supply of that book. I know that the hope of finding any is not good, but feel its the best all around book on underground warfare.

When are you going to be able to have the bulletin that you are writing ready? Is it going to be ready to sent to the printer when you let us have it, or are we going to have to retype it and do the lay out work? If you can have it ready to go right to the printer it will be a big help. We also need to know how many pages it is going to run. If its not at least 10 pages long we are going to need time to write up some additional material to fill out the bulletin. Some where between 10 to 14 pages would be ideal.

If you do not have enough material on locks to fill out that many pages fill free to use any other material that deals with underground warfare. You have copies of our other bulletins so you know the many areas that we have not covered.

I kept a copy of the names and addresses of the two members we sent you. Let me know that you received there records and I will destroy the names and addresses. The membership applications I sent you on these two members are copies I made. We always destroy the ones members send in. That way there is no application with a members name signed to it. Are you going to assign these two a mail drop in your area or keep them using the one c^h here. If you keep them assigned to a mail drop in our area we will assign them a new mail drop that we will use only for members in your state. That way we can send you there letters unopen by us.

If possible drop one of the tables you are keeping for us. We will only need three. One of the guys will not be able to make it. If you can not drop the table we will pay for it any way.

7I40I

Er Moore
TO: 7I50I

FROM: 7I40I

Sorry about the delay in contacting you, but I have been real busy since getting back. As you will note I have addressed this letter to 7I50I. This will be your number and the 7I40I is mine. Have assigned you this block of numbers to use:

7I502 to 7I550

I suggest that you start with 7I502 and work up when assigning numbers to people you recruit in person or by an agent of yours. When a person from your area writes to us over here to join up we will assign them a number out of another block of numbers and turn them over to you.

As you will note on the Organizational Correspondence To Members (enclosed) that a book "Guerrilla" by Charles W. Thayer is listed. I am enclosing two copies of this book to send the two members: 7I401 and 7I412 that I am turning over to you at this time. Send the books to them when they order the Intelligence Training Program. We only have a very small amount of these books on hand at present. I am ordering another bunch and will send you additional copies when I get them.

If you know of other paperback pocket books of this type we may be able to use in our training programs let me know. I plan to print a set of review questions to go with the Intelligence Training Program that will deal with the book. Similar to the one you wrote on the old training program, I liked yours very much.

Both of the members I am turning over are assigned mail drop 00I; Artist Supply. If you wish to assign them another mail drop in your area feel free to do so. If not they can send in their reports, dues, etc. to 00I and we in return will send them on to you at Mail Drop 005, the number assigned to the address this letter is being mailed to.

We have decided to try this break down on money:

Dues \$3 a month you keep \$2 and send us \$1
Membership Fee you keep \$3 and send us \$2
*Contributions if sent in with report form you keep half and us half

*This is only for contributions members send in on report forms. Any additional money you can raise in your area to support the organization is to be kept by you to support your state organization.

If there is any additional information or help we can give you please let us know.

Yours for Freedom

7I40I

Sam Davis

SECURITY CLASSIFICATION GUIDELINES - PERSONNEL STATUS RATINGS

- NOVICE - Classification for new members who have not proven themselves or completed any of the Basic Training Programs.
- TRAINEE - Classification for those members who have completed at least one of the Basic Training Programs or performed some other routine operation.
- MEMBER (D) - Classification for personnel who have been members for a period of at least six months but have not completed the Basic Training Programs or taken part in any but routine operations.
- MEMBER (C) - Classification for members who have completed the Basic Training Programs, but have not taken part in "Special Operations".
- MEMBER (B) - Classification for members who have not completed the Basic Training Programs, but have proven themselves by taking part in "Special Operations".
- MEMBER (A) - Classification reserved for members who have completed their Basic Training Programs and taken part in "Special Operations". All members in this classification should automatically rate the rank of Sergeant.
- LEADER (D) - Classification for Team Leaders who have not proven themselves or organized their units to the excepted level. Team Leaders in this classification should be assigned the rank of Second Lieutenant.
- LEADER (C) - Classification for Group Leaders who have proven themselves and organized their units to the proper level. Team Leaders in this classification should be assigned the rank of First Lieutenant.
- LEADER (B) - Classification for Group Leaders who have not proven themselves or organized their units to the proper level. Group Leaders in this classification should be assigned the rank of First Lieutenant.
- LEADER (A) - Classification for Group Leaders who have proven themselves and organized their units to the excepted level. Group Leaders in this classification should be assigned the rank of Captain.
- DIRECTOR - Classification for Network Leaders. All personnel assigned this classification must have proven themselves beyond any doubt. All Network Directors rate a rank of at least Captain.
- COORDINATOR - Classification for Regional or State Leaders. All personnel in this classification must have proven themselves beyond question. Coordinators rate a rank of at least Captain.

SUBJECT: Organizational Correspondence To Members (Outline)

1. Letter To Prospective Member
History Of The Secret Army Organization
To Prospective Members Of The Secret Army Organization
Membership Application Form
Join The Secret Army Organization Leaflet (one)
2. Identification Number & Mail Drop Letter
Practical Security Measures
The Combat Team
3. Training Program Letter
Preliminary Training Lesson
a. Join The Secret Army Organization Leaflets (5)
4. Intelligence Training Program
a. Book "Guerrilla" By Charles W. Thayer
5. Security Training Program
a. Practical Security Measures
6. Propaganda Training Program
a. Join The Secret Army Organization Leaflet
b. How To Organize An Underground Army Leaflet
7. Recruiting Training Program
a. Prospect Data Forms (5)

Special Instructions:

The above order should be followed in sending out the listed materials. Extra material such as organizational bulletins on Weapons, Personal Equipment, and Booby Traps should be sent to the new members to fill in spaces between the regular correspondence. The member should also be sent each new monthly bulletin. Our main concern during the Correspondence Phase will be in keeping up the interest of the new member until we can contact them personally, or put them in contact with other members. The best way to do this is to keep them busy with printed material.

Date prepared

5/10/72

Date received

5/10/72

Received from (name or symbol number)

Informant
PK 783-E

Received by

SA CLARENCE L. GRANDALL

Method of delivery (check appropriate blocks)

in person by telephone by mail orally recording device written by Informant

If orally furnished and reduced to writing by Agent:

Date

Date of Report

April 1972

Dictated _____ to _____

Date(s) of activity

Transcribed _____

Authenticated by Informant _____

April 1972

Brief description of activity or material

Source furnished Bulletin material pertaining to the SA⁹ for the month of April, 1972.

File where original is located if not attached

170-37-A

* INDIVIDUALS DESIGNATED BY AN ASTERISK (*) ONLY ATTENDED A MEETING AND DID NOT ACTIVELY PARTICIPATE. VIOLENCE OR REVOLUTIONARY ACTIVITIES WERE NOT DISCUSSED.

Information recorded on a card index by _____ on date _____

Remarks:

Source furnished the April 1972 "Underground Bulletin" of the Secret Army Organization. The subject material in this bulletin, which is attached hereto, is "the forced entry into buildings, as it applies to underground warfare,"---- and "ammonium nitrate as an explosive."

Source advised that "Coordinators and Network Directors" are to submit a monthly report to SAO headquarters via the regular mail drop or by most secure route. This report tabulates the number of members in an area, number of bulletins received from headquarters, number of bulletins distributed, number of new members recruited,

1 - 170-37-A

1 - 157-1173

1 - San Diego (info) (157-2815)

Block Stamp

157-2815-105

SEARCHED _____	INDEXED _____
SERIALIZED _____	FILED _____
MAY 23 1972	
FBI - SAN DIEGO	

Handwritten signature

identification numbers assigned, amount of money collected in dues and contributions, and amount submitted to headquarters in San Diego.

Source advised that the SAO is starting out with the policy of retaining sufficient funds in the hands of the various coordinators whereby they can operate an independent organization, so to speak. The only expenses of SAO at headquarters level involves the printing of bulletins and the renting of Post Office boxes.

The State Coordinator at Phoenix, Arizona is currently under instruction to include the State of New Mexico in his recruiting efforts.

Source advised that some of the bulletin material emanating from SAO headquarters in San Diego is being disseminated over the signature or name "CAPTAIN SAM COLLINS." The latter is regarded as a code name.

UNITED STATES GOVERNMENT

Memorandum

TO : SAC, SAN DIEGO (157-2815)

FROM : SA STEVEN L. CHRISTENSEN

SUBJECT: SECRET ARMY ORGANIZATION
EM - SAO

DATE: 4/27/72

The attached bulletin of the SAO was made available by Deputy Sheriff HAL TRIMBLE on 4/27/72. He advised it is a copy of a bulletin received by the Lemon Grove branch of the Southern California First National Bank. He added that many more copies of the bulletin had been recieved by various groups and individuals around the San Diego area.

1 - SD 15702815
SLC/slc
(1)

157-2815-81

SEARCHED	INDEXED
SERIALIZED	FILED
APR 27 1972	
FBI - SAN DIEGO	
<i>Z. Hopewell</i> (Infor.)	



Buy U.S. Savings Bonds Regularly on the Payroll Savings Plan

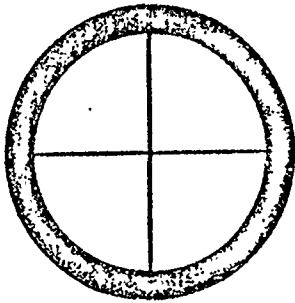

SECRET ARMY ORGANIZATION

SPECIAL BULLETIN

As most of the citizens of San Diego County are no doubt aware many liberals, pinks, reds, and other fuzzy thinking types will be bringing themselves and their gas masks here in August for a "peaceful" protest during the Republican National Convention.

While local left-wing groups are preparing for the "peaceful" protest by stock piling gas masks, flak vests, firearms and ammunition the city of San Diego is rolling out the red carpet (aptly named) for these profession revolutionaries. Yes, as strange as it may seem some members of the San Diego City government are going out of their way to make sure these communist revolutionaries are made welcome here.

Mavourneen O'Connor, twin sister of City Councilwomen MAUREEN O'CONNOR (Home address: 5821 Laurretta, San Diego, Telephone: 295-8693), is one of the more prominent members of the community who is engaged in this strange behavior. Miss O'Connor is employed by the Southern California First National Bank as a Community Relations officer, taking time off last year to run the campaign of her sister Maureen.

Her new duties are setting up a central headquarters for the protestors to use during the convention. The Unconventional Center (also aptly named) is to be this headquarters. Located at the corner of Jefferson and Riley Streets just six blocks from the Sports Arena the site of the convention, the 7,800 foot warehouse is being stocked with the expected services that may be needed by the protestors. These include; transportation, facilities for the printing of propaganda, a telephone message center, legal aid services, and a medical aid center. These last two are odd, considering its to be a "peaceful" protest.

The bill for all this is being picked up by the Southern California First National Bank who's chairman is ROBERT OSCAR PETERSON (Home address: 567 Gage Lane, San Diego, Telephone: 222-4835). Mr. Peterson has not always been a supporter of these left-wing type activities, in fact as late as January 1970 he was on the receiving end of a smear article done by the San Diego STREET JOURNAL. The Street Journal for those citizens lucky enough not to have seen an issue is one of many pro-communist underground newspapers that operate in the San Diego area.

The article on Peterson exposed his business dealings with a number of large companies; Foodmaker Corporation (owners of Jack In The Box drive-ins), and the Ralston Purina Corporation among others. At the end of the article the Street Journal made the statement that a coming article would expose other of his business dealings.

Needless to say, the article never appeared. One can only wonder now that Mr. Peterson is supporting these same type of people if some kind of blackmail was not used. Many of the members of the staff of the Street Journal live at a commune supported by the paper at 173 4th Avenue in Chula Vista.

The first news conference of the Unconventional Center was attended by these noted prominent city officials: Councilmen Gil Johnson and Jim Bates, and city manager Kimball Moore. Others not quite so prominent attending were a long haired representative from the Community Congress and Shari Whitehead, 24, a representative from the Convention Coalition. The Convention Coalition is the group that plans to coordinate the activities of protestors expected to arrive for the convention. While Mayor Wilson was not able to attend this meeting in person he later made this comment on Mavourneen O'Connor's pro-demonstration activities " I commend her for her energy and her efforts ".

Of all the organizations preparing to protest at the convention the Convention Coalition is probably the most active. Some of the leaders of the coalition are: Peter Bohmer, the off again, on again, economics professor at San Diego State, seen recently at 4931 Coronado Street, San Diego; Michael Kenneth, address 3777 Fairmont, San Diego; Pam Williams, also seen at the Coronado Street address; and last, but not least, Doug Porter, recently seen at 2445 Albatross, San Diego. Headquarters for the coalition are at 309 6th Street in San Diego.

While the Intelligence Branch of the San Diego Police Department has reported to city officials the militant activities (stock piling weapons and explosives) of these leftist groups the city fathers have annoy all warnings. Instead of spending every dime the city can spare on weapons and equipment to help the police put down a possible riot the powers to be believe the money can better be spent for SENSITIVITY TRAINING.

While the left is planing a full scale battle the public officials of San Diego spend the tax payers money on sensitivity training for the police department. And guess who they pick to teach this garbage, a foreign born (Iran) Professor of Psychology who was kicked off the staff at San Diego State because of his profanity and teaching of left-wing views. JAUAD EMAMI was a Assistant Professor at SDS before having been removed, he and his wife Minou live at 3850 American Avenue in La Mesa. The 5'10", 190 pound, black hair, brown eye professor was educated at UCLA and the University of Arizona. Emami drives a white van (California ZMJ 481) and is payed \$25 an hour to teach our policemen to talk nice to these creeps that will be invading San Diego in August.

Instead of hiring this fuzzy headed professor the SAO believes the City of San Diego should have hired Lieutenant Cally, then at least the police would have received some expert training on how to handled RED TRAITORS.

UNITED STATES GOVERNMENT

Memorandum

TO : SAC, SAN DIEGO (157-2815)

DATE: 3/31/72

FROM : SAC, LAS VEGAS (157-997) -P-

SUBJECT: SECRET ARMY ORGANIZATION (SAO)
EM - SAO

OO San Diego

Rereport SA STEVEN L. CHRISTENSEN at San Diego,
dated 1/21/72.

On 2/8/72, a review of the Las Vegas City Directory disclosed that telephone number 384-2046 is listed as being the number of EDWARD B. JOHNSON, 2400 Sunrise, Apt. 12, Las Vegas, Nevada.

On the same date, a review of the City Directory concerning telephone number 642-4467 was negative. Numerous attempts to contact anyone at this number were met with negative results.

On 2/28/72 ^{Third Agency} [U.S. Postal Inspector RICHARD POLZIN, Las Vegas, Nevada, advised that P.O. Box 2191 was originally rented on 9/6/68 by JULIUS STEINER, 2004 Brady, Las Vegas, Nevada. STEINER identified himself by means of California driver's license M-433240.

On 3/10/72, a check of the files of the Las Vegas Police Department was negative concerning EDWARD B. JOHNSON or JULIUS STEINER. Las Vegas indices were also negative concerning these individuals.

On 3/10/72 and 3/22/72, spot checks at 2400 Sunrise and 2004 Brady were negative and no automobiles were observed registered to either STEINER or JOHNSON.

On 3/23/72, the individuals identified below were furnished background information concerning SAO, and all

- 2 - San Diego
- 2 - Sacramento
- 2 - Las Vegas
- (1 - 157-553)

WLK:tlw
(6)



157-2815-57

SEARCHED.....	INDEXED.....
SERIALIZED.....	FILED.....
APR 2 - 1972	
FBI - SAN DIEGO	

Charles Johnson

Buy U.S. Savings Bonds Regularly on the Payroll Savings Plan

LV 157-997

advised that no information concerning this organization has come to their attention:

Lt. JOHN CONNOR, Las Vegas Police Department,
Intelligence Unit.

Detective JOHN HOLLAND, North Las Vegas Police
Department.

Lt. MARTIN, Clark County Sheriff's Office.

These individuals stated that in the event any information is received by their respective department concerning the SAO or any individuals connected with it, such information would be furnished to the FBI.

LEADS:

SACRAMENTO DIVISION

At Sacramento, California:

Will review records of Department of Motor Vehicles concerning JULIUS STEINER, DL #M-433240, for background and descriptive data.

LAS VEGAS DIVISION

At Las Vegas, Nevada:

1. Will continue efforts to identify ED (LNU) and attempt to determine if he is identical to EDWARD B. JOHNSON, 2400 Sunrise, Apt. 12.
2. Will attempt to further identify JULIUS STEINER, 2004 Brady, the holder of P. O. Box 2191.
3. Will, following receipt of the results of subpoena to Central Telephone Company, Las Vegas, report the identity of the subscriber to telephone number 642-4467 and determine if this person is identical to JACK DOYLE or JACK CONAN DOYLE, JR.

THOMPSON, BUNKER, SULLIVAN & McGRATH
ATTORNEYS AT LAW
814 SAN DIEGO TRUST & SAVINGS BUILDING
SAN DIEGO, CALIFORNIA 92101
TELEPHONE 234-6781

DAVID H. THOMPSON
JAMES E. BUNKER
ROBERT G. SULLIVAN
DONALD McGRATH II

March 22, 1972

Special Agent Gibson
Federal Bureau of Investigation
3211 Fifth Avenue
San Diego, California 92103

Dear Mr. Gibson:

As I am a former FBI Agent, one of my friends forwarded to me information which she received through the mail from a "Secret Army Organization." You probably have this background information, but if not, I felt that it deserves your consideration and attention.

Mrs. Lusk does not know why the literature was forwarded to her. She is employed by the Pacific Telephone Company and several weeks ago she wrote a Letter to the Editor which was published in the Union Tribune on the subject of amnesty for the draft dodgers.

If you desire any further information concerning this matter, please give me a call.

Very truly yours,

James E. Bunker
James E. Bunker

JEB/hi
Encs:

157-2815-54

SEARCHED	INDEXED
SERIALIZED	FILED
MAR 28 1972	
FBI-SAN DIEGO	
<i>Christina</i>	

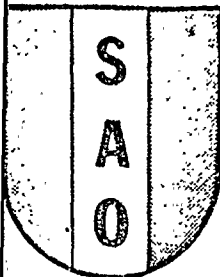

SECRET ARMY ORGANIZATION
GENERAL HEADQUARTERS

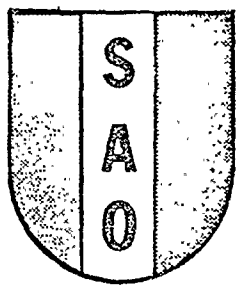

Dear Fellow American,

At the request of a mutual friend we are sending you this invitation to join the Secret Army Organization. Those of us who have been members for some time sincerely believe that our organization can be of real value in preserving for future generations the land of freedom and opportunity which our forefathers handed down to us.

It is the belief of our organization that the communist-socialist conspiracy has infiltrated the United States Government to such an extent that the American people cannot rely on this country's elected leaders to protect them from communist domination and slavery.

We believe that the time will come when the American people will have to fight for their lives and their liberty. In this belief, we have formed in advance a secret underground army with but one objective, to defend our constitutional republic and to help our fellow Americans to do the same.

We do not want lukewarm members. We are an organization of people willing to make any sacrifice necessary for our country. If you feel the same way, we invite you to join us.

SECRET ARMY ORGANIZATION

157-2815-53

SEARCHED	INDEXED
SERIALIZED	FILED
MAR 28 1972	
FBI - SAN DIEGO	
<i>Christensen</i> <i>me</i>	

JOIN THE SECRET ARMY ORGANIZATION

An organization of loyal Americans
dedicated to the preservation of both
national and individual freedom.

1. To prepare the means of personal defense and survival in case of enemy attack.
2. To resist and expose the spread of communist influence and propaganda within our own national boundaries.
3. To investigate by means of our own secret memberships the infiltration of communist sympathizers into American organizations of government and propaganda within religion and education.
4. To resist by any and all means the passage of laws which regulate the private ownership of firearms or which detract from the individual's ability to defend his own family and personal property.
5. To promote knowledge and skill in the use of arms by our own members and by the general public.
6. To form in advance of actual need a secret underground organization equipped to spy upon, harass and destroy troops of any foreign power that might occupy United States territory.
7. To lend assistance and support wherever possible to other resistance organizations, domestic or foreign, opposing communist expansion or subversion.
8. To pursue these programs as private citizens motivated only by patriotism and to remain entirely free of government subsidies or control.

History of the Secret Army Organization

One early morning in February, 1970, a group of six Minutemen leaders from four states met secretly in Northern Arizona to discuss the crisis that the arrest and imprisonment of two top Minutemen leaders and the assassination of a third had brought on the organization. Although some of these men had met before in their roles as Minutemen group leaders, others were meeting for the first time.

After much discussion, two principal points were agreed upon. First, that the Minutemen as a national coordination organization of militant right-wing groups had effectively been destroyed by the pro-communist elements inside the Justice Department. While individual units still existed throughout the country, few had the financial support or leadership to be really effective. Second, that the need for such a coordinating organization was greater than ever in view of the increased revolutionary activity by communists in the United States.

With these two points in mind, suggestions were put forward on a course of action to be followed. After a meeting that lasted all that day and far into the next morning, an overall plan of action was finally agreed upon. All present agreed to merge their individual units together and form a new organization under the command of one leader elected from among themselves, with the other five to be members of a General Staff that would advise and assist the new leader.

While retaining the basic programs and policies of the Minutemen, it was decided that not only should this new organization have a different name, but also a completely new chain of command and organizational structure. If the new organization was going to survive the attacks that befell the old one, a whole new approach would be needed. Never again could the arrest or death of a few leaders be allowed to cripple the entire organization.

For this reason it was decided that only a highly disciplined military type organization with a definite chain of command would have any chance of success. This then, was the beginning of the Secret Army Organization. Beginning with an original force of hard core patriots that numbered fewer than two hundred, the Secret Army Organization began the job of picking up the pieces and continuing to fight for national and individual freedom. Using this cadre of dedicated personnel as a nucleus, the S. A. O. has been recruiting and training new members in the skills they will need as the freedom fighters of tomorrow.

The leaders of the S. A. O. have no idea of fighting a last ditch stand. We have no desire to commit suicide ourselves or to let our members do so. We have a strategy which we believe will ultimately lead to victory. Only one thing is essential. We must start preparing and training NOW! We of the S. A. O. believe that our country is worthy of any sacrifice. If you feel the same way, we invite you to join us.

APPLICATION FOR MEMBERSHIP

NOTICE TO APPLICANT: All information on this form will be kept confidential. All records of members of the Secret Army Organization are stored in a way that they can be swiftly destroyed to keep them from falling into unauthorized hands.

Name _____ Sex _____ Age _____

Address _____ Marital Status _____
(Street)

State _____ Wife's Name _____

Zip Code _____ Telephone _____

Date of Birth _____
(Month) (Day) (Year)

Occupation _____ Education _____

Special Subjects Studied _____

Do You Speak or Read Any Foreign Language? _____

Veteran _____ Branch _____ Highest Rank _____

What Service Training Have You Had That You Feel Would Be Beneficial To This Organization? _____

Physical Description: Height _____ Weight _____ Color Eyes _____

Color Hair _____ Health: Good _____ Fair _____ Poor _____

Any Physical Disabilities or Limitations? _____

Any Public Speaking or Organizing Experience? _____ If Yes, Please Explain: _____

How Many Hours A Week Could You Devote To Working And Training With the S. A. O. ?

Hours _____ Best Time: AM _____ PM _____ Weekdays _____ Weekends _____

CERTIFICATION

I am a loyal American Citizen dedicated to the defense and survival of the United States as a Constitutional Republic, free from all socialist and communist policies. Enclosed is my \$5.00 membership fee. I agree to pay \$3.00 each month to the Secret Army Organization as membership dues.

To Prospective Members Of The SECRET ARMY ORGANIZATION

The Secret Army Organization is the most active, most completely dedicated and most selective in its membership of all the many patriotic organizations in America. We are willing to make any sacrifice for our country and we fully expect that some of us will have to make the ultimate sacrifice before victory is achieved. Our very lives depend on each other. There is no place in this organization for bunglers, playboys or lukewarm conservatives. If you join the Secret Army Organization, there might easily come a time that your life would depend on how competently some other member had learned his job.

Unless you are especially well informed on the domestic and world political situation, it is probable that you have a lot to learn about the present threat our nation faces. Unless you have had many years experience in actual underground warfare, there is undoubtedly a lot you can learn from the experts in our organization who have developed and supervised our training program.

OUR NATION IS IN IMMEDIATE DANGER

It is possible that within a very few years, perhaps even within months, our nation could be conquered and enslaved by the communists. To prevent this we must know as much as possible about our enemies. Unless we know who they are and what they are doing we will not succeed in our efforts to maintain a free America.

THE RESISTANCE MOVEMENT

In driving an invader from your land the resistance involved goes through three stages of development.

- 1) The Underground Network
- 2) Active Guerrilla Warfare
- 3) Open or Conventional Warfare

The conventional warfare stage uses everything in the way of weapons that the enemy does but must also have active guerrillas and underground agents working against the enemy, too. In the present state of military tactics conventional warfare cannot succeed unless these other two ingredients are used simultaneously.

The first step is to form an underground network. An active guerrilla system must have the support of an underground network of approximately three times its own size. This underground must supply the active guerrilla fighter with supplies, concealment, information, etc. An underground network starts with departments of intelligence, security and propaganda in that order.

Sabotage, espionage, subversion, infiltration, escape and evasion, training, clandestine fabrication of supplies, counterfeiting enemy documents, recruiting, communications and propaganda are other phases of underground activity. Each member of the Secret Army Organization, to be effective, must have a working knowledge of all these tactics as well as the military tactics more commonly associated with guerrilla activities.

ASSIGNMENT TO UNITS

Many people that inquire about membership in the Secret Army Organization seem to have an idea that they will be immediately accepted into an active unit. Look at it this way. Suppose you had spent a year or more carefully recruiting and training until you had a hard hitting team where every individual was reliable, dedicated, and had confidence in his fellow unit members. Wouldn't it make you mad to have the national or regional organization assign some rank amateur to your unit that you you knew little or nothing about?

Before any new member is assigned to an active unit or to an important underground project, he must undergo a period of training. During this training he will be directed through the mails by an experienced member and some of his activities may be observed by other members without his knowledge. Only when a new member proves himself to be conscientious, trustworthy, self-disciplined and able to operate effectively alone will he be accepted as a "secure member" and invited to participate with other unit members in a teamwork operation.

EXPENSES

Unfortunately, most good things don't come cheap. Although we make every effort to keep down the expense of membership in the Secret Army Organization, you must expect to pay your own way.

Dues to the Secret Army Organization are \$3.00 per month. This money is absolutely necessary for use to maintain our central files and headquarters, for postage and printing, to finance our extensive intelligence network, and to maintain training areas.

Each member will have other expenses depending on the type of activity he is engaged in. Every member will be expected to buy his own gun, ammunition and other basic combat equipment. During training the new member may be expected to buy certain books or subscribe to certain magazines that his work requires. During this time the new member will also be supplied with reading material on the strategy and tactics of guerrilla warfare. This home work will make it possible for him to fit in quickly to an active unit and participate effectively in actual maneuvers, marksmanship training, etc.

Following this preliminary training a member may be either assigned to an existing unit, assisted in organizing his own unit if he has shown sufficient leadership qualities or become part of an underground network.

Upon your acceptance into the Secret Army Organization you will be given a definite series of projects described in writing so you will know exactly what will be expected of you.

We hope that you can succeed in this effort because your country desperately needs patriots at this time.

ALWAYS USE
ZIP CODE

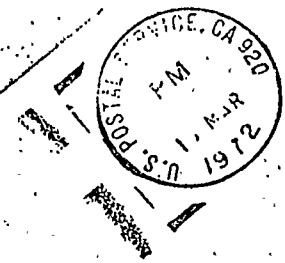

STANDS COMPANY
5100 L CAMD N BLVD.
SAN DIEGO 15, CALIF.

Mrs. E.M. IUSK
4150 Cleveland
San Diego, California

FOR PLEASURE & PROFIT

3211 Fifth Avenue
Post Office Box 3636
San Diego, California 92103
March 23, 1972

Mr. James E. Bunker
Attorney at Law
814 San Diego Trust & Savings Building
San Diego, California 92101

Dear Mr. Bunker:

I wish to express my appreciation for your letter of March 22, 1972, enclosing material relating to the Secret Army Organization, which had been received by an acquaintance of yours, Mrs. E. M. Lusk.

If it is believed further information in this matter is necessary, you will be contacted by a Special Agent of this office.

Sincerely yours,

ROBERT W. EVANS
Special Agent in Charge

1 - Addressee
① - San Diego (157-2815)

ACG:mt
(2)

mt

157-2815-52
SEARCHED.....INDEXED.....
SERIALIZED.....FILED.....

UNITED STATES GOVERNMENT

Memorandum

TO : SAC, SAN DIEGO (157-2815)

DATE: 3/17/72

FROM : ~~THE~~ SAC, BALTIMORE (157-6675) RUC

SUBJECT: SECRET ARMY ORGANIZATION (SAO)
EM-SAO
OO: San Diego

Re San Diego report of SA STEVEN L. CHRISTENSEN dated 1/21/72.

Enclosed for San Diego is one copy of Baltimore report of SA JOHN J. GROGAN titled EM-MINUTEMEN.

Enclosed report should provide sufficient information regarding the Minutemen Organization operated by JESSIE CLAYBURN STEVENS of Brentwood, Maryland. Baltimore has a separate case on JESSIE CLAYBURN STEVENS and it should be noted that STEVENS is carried as ARMED & DANGEROUS.

The most current information supplied by ^{Informant} [BA T-2] in enclosed report indicates that JESSIE STEVENS has continued to lose popularity in the Maryland area. This loss of popularity and support can be attributed to constant accusations that STEVENS is an informant. Statements made by ROBERT DE PUGH concerning STEVENS' character have also considerably weakened his support since the writing of enclosed report.

Contacts with the following sources who are familiar with White Extremist activities in Maryland, and specifically, Minutemen operations conducted by STEVENS, failed to indicate that STEVENS has formed an alliance with SAO. Sources indicate that STEVENS may have formed an alliance but has not made this information generally known:

BALTIMORE

- Informant (BA 1392 E(Prob)) 3/13/72
- Informant (BA 3005 E(Prob)) 2/16/72
- Informant (BA 2003 E(Prob)) 3/13/72

- ② - San Diego (RM) (Encl. 1)
- 1 - Baltimore *wac*
- WVD:lmk
- (3)

157-2815-51

SEARCHED	INDEXED
SERIALIZED	FILED
FBI - SAN DIEGO	

W. J. ...



Buy U.S. Savings Bonds Regularly on the Payroll Savings Plan

BA 157-6675

SAC, SAN DIEGO (157-2815)

DATE: 3/17/72

ANNAPOLIS

Informant
BA 1898 E(Prob)

2/28/72

SECRET ARMY CONCENTRATION AREA

Detective CHARLES TENNY of the Baltimore County PD, Intelligence Division, conducts White Extremist investigations in the county. TENNY has advised he is aware of SAO activity on the west coast. He has, in fact, corresponded with this organization. Detective TENNY, after canvassing his White Extremist sources in Baltimore County, corroborated the information that STEVENS has not formed a working alliance with SAO.

Report of Baltimore PD San Diego is one copy of Baltimore

On 3/14/72, Baltimore Division received a copy of a Dallas Informant Report. Dallas informant DL 393-E advised on 2/14/72 that a Minuteman supporter named ROY BROWN, from Christoval, Texas, had been in contact with JESSIE STEVENS. In an exchange of letters between BROWN and STEVENS, it was learned that STEVENS is going to travel to Texas and on into Mexico in the last half of March, 1972. Baltimore has no information re specifics of this trip, but San Diego might contact Dallas to see if STEVENS attempts to contact any SAO supporters in Texas.

In view of the above information, Baltimore is no longer conducting any further investigation regarding SAO and the proposed alliance with JESSIE STEVENS' organization. If office of origin determines by west coast investigation that such an alliance exists, Baltimore should be notified and they will reactivate investigation.

Minuteman supporter contacted by TENNY, failed to indicate that STEVENS has formed an alliance with SAO. Sources indicate that STEVENS may have formed an alliance but has not made this information generally known.

BALTIMORE

- BA 1898 E(Prob) 3/13/72
- BA 3000 E(Prob) 2/28/72
- BA 3000 E(Prob) 3/13/72

- 2 - San Diego (RM) (Encl. 1)
- 1 - Baltimore

(3)

GENERAL INSURANCE AGENCY

OF SAN DIEGO

2020 EL CAJON BOULEVARD
SAN DIEGO, CALIFORNIA 92104

PHONE 297-4754

EDWARD A. FURBUSH

ATT. OF _____

TO F. B. I.

SAN DIEGO, Feb. 22, 1972.

RE: _____

The enclosed was inserted in the mail slot of our door during the night of Feb. 21, 1972.

Having worked for the F.B.I. myself, I hesitate sending in this type of material but it makes me furious to think someone would pass this type of thing out.

Mildred Furbush

Mildred Furbush

*Acknowledged
with appreciation 2/23/72
AM*

*Christman
Per our conversation
forward copy to
Beene's office
AM
4/23*

157-2715-49

SEARCHED <input checked="" type="checkbox"/>	INDEXED <input checked="" type="checkbox"/>
SERIALIZED <input checked="" type="checkbox"/>	FILED <input checked="" type="checkbox"/>
FEB 23 1972	
FBI - SAN DIEGO	

Christman

WANTED

for TREASON



NIXON

DESCRIPTION

RECEIVED FEB 2 1972



NIXON

DESCRIPTION

FULL NAME: Richard Milhous Nixon. **DATE OF BIRTH:** January 9, 1913 at Yorba Linda, California. **FORMER OCCUPATIONS:** Used car salesman, law clerk, second rate congressman, and mediocre Vice President. **PRESENT OCCUPATION:** Professional liar and double crosser (part time employment as United States President). **WEIGHT:** 170 pounds. **EYES:** brown. **HAIR:** black. **HEIGHT:** 5'11". **RACE:** White. **NATIONALITY:** Claims American citizenship but actions prove this unlikely. **LAST KNOWN ADDRESS:** 1600 Pennsylvania Avenue, Washington, D. C. (Rumored to have a California hideout.)

CRIMINAL RECORD

RICHARD NIXON (alias Cry-Baby Nixon, alias Tricky Dicky) is an expert in disguises and has successfully passed himself off as an anti-communist in the past. He may again try using this disguise if pressed for votes in 1972. Saying one thing, then doing the opposite is Nixon's MOA. While he campaigned in 1968 on a platform of curtailing socialism he has in fact done more to establish a socialistic dictatorship than either of the last two Democrat administrations. His economic policies have continued to enrich Big Industrialists while rising prices and higher taxes have all but reduced the average worker to a state of financial slavery. This criminal has even made vicious attacks on small children (forced busing to achieve "racial balance") and has caused the destruction of local school systems. **WARNING:** Nixon suffers from an EMPEROR COMPLEX and becomes extremely dangerous when criticized.

CAUTION

Trickery and deceit are Nixon's trade-marks. At the present time Nixon and his chief henchman HENRY (CZAR) KISSINGER are engaged in forming an alliance with another gang of criminals, the Red Chinese. The RED CHINA GANG have slaughtered an estimated fifty million of their own people since coming to power. This Godless horde of barbarians killed thousands of Americans in the Korean War (shooting captured soldiers and starving and torturing prisoners of war). The RED CHINA GANG have been supplying the NORTH VIETNAMESE BANDITS with weapons and bullets to kill American soldiers in another no-win war in Vietnam. The very fact that Nixon is dealing with these ARCH ENEMIES OF FREEDOM is enough to convict him of treason. **DO NOT LET THIS CRIMINAL STEAL YOUR FREEDOM. DEMAND HIS ARREST BY PROPER AUTHORITIES AND HIS TRIAL FOR THE CRIME OF HIGH TREASON.**



Secret Army Organization

100-16200-Sub 4-9P2
"Calup"

2/72 106-16200-Sub 10-2P2

SEARCHED INDEXED
SERIALIZED FILED
FEB 2 1972
FBI - SAN DIEGO

UNITED STATES GOVERNMENT

Memorandum

TO : SAC, SAN DIEGO (157-2815)(P)

DATE: 3/9/72

FROM : SA DONALD R. BELMONT

SUBJECT: SECRET ARMY ORGANIZATION (SAO)
EM

Attached letter re captioned organization was received this date by mail at the Escondido RA from DONNA LEE HARTLEY, 615 N. Melrose Drive, Calif.

No action being recommended, and it is suggested no acknowledgement be made of receipt of letter, since any acknowledgement results in another flood of letters from her.

(1)
DRB

157-2815-38

SEARCHED _____	INDEXED _____
SERIALIZED _____	FILED _____
MAR 13 1972	
FBI—SAN DIEGO	

Christensen

Buy U.S. Savings Bonds Regularly on the Payroll Savings Plan



CONFIDENTIAL!

Donna Lee Hartley
615 N. Melrose Drive
Vista, California 92083

February 29, 1972

Mr. Belmont
FBI
659 Escondido Blvd.
Escondido, California

Dear Mr. Belmont:

Since reading about the FBI files and records being stolen by Radicals, I implore you to either destroy my last letter about the Secret Army Organization or send it back to me, and not to keep it in your regular files, if this is what is done with all correspondence. Also, it's hard to say who will be the next director of the FBI, or whether he, or the people he appoints will be able to be trusted--as J. Edgar Hoover and his men. There will never be a man as good or competent as J. Edgar Hoover. And I fear for the safety of our Country, if and when he retires! (I do not trust Nixon, I don't even respect him, and he is not, what many people used to think he was!)

If the SAO, are truly dedicated Counter-Revolutionary's, then they are your only hope, and mine, and it would seem that every loyal Police Officer and FBI agent in the U.S.A., would have to join in the battle with us, should we be taken over--or Civil War break out. Therefore, it would be in your best interests to either destroy the letter I sent inquiring about the SAO, (after talking to Nancy Byrd, of the Sheriff's Dept. Deputy Byrd) I feel more confident, that they are all I hoped they would be, and also, out to help the Police and to protect them.

Because of Govt' interference I'm sure the SAO wouldn't have wanted me writing to you, not because they don't trust FBI agents or J. Edgar Hoover (I'm sure) but because they know there are Red's high up in the Govt. and they don't trust ANY Attorney General's anymore, for which I don't blame them!! (Any Attorney General who would quit to try to get Nixon elected, has to be very left of center--to put it mildly! Except for J. Edgar Hoover and you FBI agents, and the Conservatives--Washington D.C. is rotten to the core!!!!

I would never betray the SAO, and I guess I shouldn't have written to you about them, in case the FBI records get into the WRONG HANDS, but I just wanted to find out your professional opinion on them, and also find out, if I actually walked into a Red trap.

-2-

March 7, 1972

I sincerely hope you can indeed, have my previous letter in regard to the SAO destroyed. If it ever got into enemy hands, which it surely would if a leftist were to be appointed as director of the FBI, I would be assassinated, and perhaps my children killed too.

Much to my shock the Reds already know about the SAO, (but HOW, I don't know, as they maintain the utmost in secrecy and security.) and if the Communists hate them, (or us) as much as they say they do, they they must be wonderful people!

If the SAO are true patriots, with high principles and standards, and if they have faith in God to deliver us from our brutal deadly enemies, then I would do all I could to help them--within the Law.

The only reason I revealed all this information to you, and to my friends in the San Diego County Sheriff's Dept., is because, as I said to Sgt. Paul Franklin, I know I can trust you, and we are on the same side. I never would have given this information to the Sheriff's Dept, if I didn't know him, and many of his men personally, and in fact I worked on his campaign to elect him Sheriff, as did many a John Birch Society member, who knew for sure he was a loyal American, and a man for LAW AND ORDER, and an Anti-Communist. (By him, I mean Sheriff John Duffy.)

I asked Sgt. Franklin, to keep the SAO material out of the regular files. All we can do is HOPE, that the Sheriff's Dept., and other Law Enforcement agencies aren't infiltrated with Reds!

After much studying and serious reflecting, I can see no hope for America, unless we ALL band together in a highly organized Counter-Attack, in a strong purposeful underground group and fight for our liberty and our lives--or else be reduced to a satellite slave nation.

Who could know the inside story better, than the top military men, who are leading the Counter-Revolutionary's? They were not allowed to win the Korean or Vietnam wars, and had to watch our fine young men die--in vain. (50,000 they tell me, in the Vietnam war, alone, not to mention the Korean fiasco.) The blood from these men--cries out for justice, and for recompense, from the criminals who ordered them to die--for nothing--or for the Viet Cong, or Soviet KGB!

Surely God will grant eventual justice for these men--as well as all the murdered American Policemen, and those of the rest of the free world also. The traitors should not go free.

MAY GOD HELP US--

Very Respectfully,

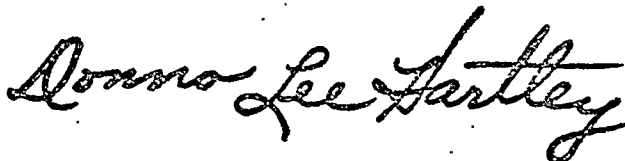

Donna Lee Hartley

Rec'd 3/9/72
0882

Organization was
Ho RA from DONFA

and it is suggested
letter, since any
of letters from

CONFIDENTIAL!

Bx 1779

MR. BELMONT
FBI
659 ESCONDIDO BLVD.
ESCONDIDO, CALIFORNIA

U.S. MAIL SERVICE
AM
8 MAR
1972

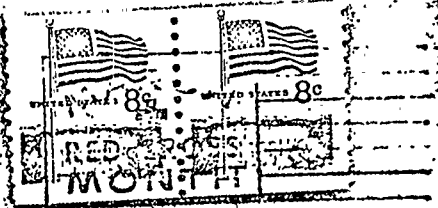

157-2215-
SEARCHED INDEXED
SERIALIZED FILED
MAR 13 1972
FBI—SAN DIEGO

Payroll Savings Plan

UNITED STATES GOVERNMENT

Memorandum

TO : SAC, SAN DIEGO (157-2815)(P)

DATE: 3/6/72

FROM : SA DONALD R. BELMONT

SUBJECT: SECRET ARMY ORGANIZATION (SAO)
IS - SAO

Attached hereto is a letter received at the Escondido RA from DONNA LEE HARTLEY, 615 N. Melrose, Drive, Vista, California, in which she advises she has joined the SAO because of her concern over the Communist threat.

On 3/6/72, Mrs. DONNA HARTLEY was telephonically contacted by SA BELMONT for the purpose of acknowledging her letter. She was informed that the FBI could not furnish her any information concerning the SAO or advise her as to whether she should or should not join this organization. She stated she became interested in the SAO after she read an article in the San Diego Union concerning the shooting incident involving PETE BOHMER, in which "the communists were blaming the shooting on the SAO." She thereafter wrote a letter to SAO and she received some literature on the history of SAO and also received an application for membership in SAO, which she filled out and sent in.

She stated since making application with SAO she has realized that this organization condones violence, which she does not. However, she plans to remain in the organization, for the time being at least, for the sole purpose of obtaining information concerning its activities and furnishing it to the San Diego County Sheriff's Office. She has written to Sgt. PAUL FRANKLYN, Intelligence Unit, SDSO, and a ~~xxxx~~ Deputy NANCY BYRD of the SDSO has come to see her and has indicated she will be contacting her in the future about SAO. She stated the SDSO has indicated they will pay her dues in the SAO.

It should be noted that DONNA LEE HARTLEY is a prolific letter-writer, not only to the Bureau but to the newspapers, particularly the Daily Times-Advocate, Escondido. She is very pro-Bureau and pro-law enforcement. She appears to be obsessed with the idea of becoming an informant; however, it is not recommended that she be utilized as such.

(2)
DRB

*Agree
DRB*

157-2815-320

SEARCHED	INDEXED
SERIALIZED	FILED
MAR - 7 1972	
FBI - SAN DIEGO	

Christensen



Buy U.S. Savings Bonds Regularly on the Payroll Savings Plan

3/3/72

debbz

una Lee Hartley
N. Melrose Drive
sta, California 92083

bruary 25, 1972

CONFIDENTIAL!

as to the SECRET ARMY ORGANIZATION,
in the Law. It is a Counter-Revolutionary
ed becoming active in it, if they are
, indæed they ARE on the side of the
wondering--could they be a Red trap?

electronic surveillance, counter-
infiltration tactics, etc.
he side of the Police and FBI I would
efore sent me an application. (Which
on the side of the Police and FBI.
the thought dawned on me, that maybe
strated, how do I know?

It seems so tragic to me, that
on, because of the permissive
no death penalty even.
ing in freedom, the "Pursuit
ppiness"--supposed to do?
the seeming inevitable
sworn to resist a takeover to
being strangled, in a pincers
sympathizers at the very top
es at the bottom--the Revolutionaries!

SOMEBODY DO SOMETHING!!.

AGENTS???? To the POLICE?

ded American blame those of us, who
r-Revolutionary Army--since our own
d infiltrated? The Police can no
have been rendered helpless and useless
Supreme court have destroyed America.

I don't intend to break any laws--but some laws were made by Communist
Sympathizers. Those of us who have the Spirit of 76 in us, simply
cannot sit back and passively wait to be engulfed in the most hideous
tyranny and slavery and evil, that the world has ever known.

DO YOU BLAME US?

FBI
Mr. Belmont
659 N. Esccondido Blvd.
Esccondido, California

BX 1779

S. P. C.
26 FEB
1972

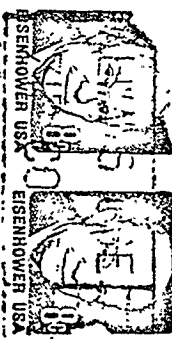

Donna Lee Hartley
615 N. Melrose Drive
Vista, California 92083

February 25, 1972

FBI
Mr. Belmont
Escondido, California

Dear Honorable Sir:

I am seeking your expert advice, as to the SECRET ARMY ORGANIZATION, and to whether or not it is within the Law. It is a Counter-Revolutionary militant group. I have considered becoming active in it, if they are truly what they claim to be. If, indeed they ARE on the side of the Police, and the F.B.I. Or, I am wondering--could they be a Red trap?

They have sent me literature on electronic surveillance, counter-revolutionary combat training, infiltration tactics, etc. I told them, if they "were on the side of the Police and FBI I would be glad to join them, they therefore sent me an application. (Which at once verified that they were on the side of the Police and FBI. After I sent the application in, the thought dawned on me, that maybe it's a trap. Maybe they are infiltrated, how do I know?

Mr. Belmont, we at war with Communism. It seems so tragic to me, that we no longer have any Federal protection, because of the permissive courts, and traitorous judges, and now, no death penalty even. What are those of us, who insist on living in freedom, the "Pursuit of Life, Liberty, and the Pursuit of Happiness"--supposed to do? Are we supposed to sit back and wait for the seeming inevitable death warrant for those of us who have sworn to resist a takeover to our last breath? We, the people, are being strangled, in a pincers strategy--the big Communists and their sympathizers at the very top of our Government, and the little ones at the bottom--the Revolutionaries!

In the name of Heaven, why doesn't SOMEBODY DO SOMETHING!!!

WHAT IS GOING TO HAPPEN TO YOU FBI AGENTS???? To the POLICE?

Really now, can any true red-blooded American blame those of us, who want to join an effective Counter-Revolutionary Army--since our own armed forces are so mutinous and infiltrated? The Police can no longer protect us, because they have been rendered helpless and useless by the courts. The Reds in the Supreme court have destroyed America.

I don't intend to break any laws--but some laws were made by Communist Sympathizers. Those of us who have the Spirit of 76 in us, simply cannot sit back and passively wait to be engulfed in the most hideous tyranny and slavery and evil, that the world has ever known.

DO YOU BLAME US?

In my profound grief and heartache, and frustration over our National situation, I have joined this Pro-American militant group.

The SECRET ARMY ORGANIZATION.

But, I repeat--are they really Pro-American, or have I walked into a TRAP? The Communists have succeeded in causing unprecedented SUSPICION and FEAR, in our once great and glorious Nation. Now we are reduced to suspicious and wary warring factions--a CIVIL WAR!

As I have said before--I would rather that we (my children and I) die, than to live under Communism. (The next world, with God, will be better than this one anyway!)

If Red China is going to take us over (and it looks like soon) then I'd rather work in an underground Resistance movement--and die like a true American with Red blood in my veins, instead of a yellow stripe down my back. (Though I'm not saying I'm not scared--or maybe even paranoid--by now!)

I never thought such a disgusting thing would happen to our beloved America. Truly, it looks like the days of the Vigilantes--has been forced upon us--(probably deliberately!)

Many people I know, are confused, terror stricken, and "their hearts failing them for fear."

In my present economic situation I suppose I have no right to complain about "big Government", but--the rights of the people, the freedom's and the liberty are slipping away from us. Should we let it all go down the drain--without a fight to the death? Conservatives who are patriotic and love America have been silenced and even persecuted for their beliefs.

(I realize you know all this.)

Religion, God, and the Bible is now being attacked, as is the sanctity of the home.

I joined this group(S.A.O.) in the belief, that they are Pro-American, Pro-Police, and Pro-FBI.

May I please hear from you (I also wrote to Sgt. Paul Franklin, of Vice & Intelligence.) as since doing some reflecting and pondering over the literature they sent me, I am wondering if I did the right thing, or if I did walk into a TRAP.

It is my profound desire not do anything that would be frowned upon by the true American FBI or truly dedicated Police. (I'm sure MOST of them can be trusted--but I am now begining to wonder if the SAO believes this.)

Nothing nor nobody, will ever diminish my great respect and gratefulness for the FBI. If the SAO does not feel this way about the FBI, then there has to be something wrong with them, and in that case, I want nothing to do with them, and will tell them so. (In which case, I may find myself being aimed at from two directions.

They may be okay, but I desperately, need your advice and opinion, in this matter. I don't want to do anything illegal, and I want to help my Country, not hurt it, in any way. Frankly, I'm not sure what I've gotten myself into--the intrigue and suspense is unbearable.

In yesterday's secret mailing of literature to me, I was told I will be sent training instructions in two weeks. (Counter-Revolutionary Guerrilla Warfare, actual Combat, and underground resistance tactics. Most of the literature yesterday was on electronic surveillance, and the various weapons needed, plus other equipment needed. Plus the stickers shown below.)

FIGHT COMMUNISM

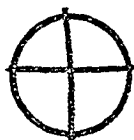

join the
**SECRET ARMY
ORGANIZATION**

write

SAO Box 5791, San Diego, Calif. 92105

It seems logical, that if our Government is taken over completely by the Red's--then you FBI agents, plus the loyal Police and all true American Law Enforcement people, will be forced to join something like this. Right? I don't see what choice you will have. Otherwise they will kill all of you. Please don't let that happen.

No matter what our status in life, or economic bracket, everyone of us, will have to pull together, unite and put everything we have into this fight for survival. The lines have already been drawn--there is no middle road! With the Pro-Communist feeling now being fostered by certain traitors in our Govt. and ALL the main news media--what choice do we have--but to join an organization that trains us to fight the enemy, with the resolve to overthrow him. The true Americans will be HATED with a Satanic passion--because of this massive brainwashing of the general public going on right now. This masochistic mania to embrace bloody Red China--is the ultimate of insanity and criminality!!!! It seems like an unreal, hellish nightmare to so many of us.

If the SAO is really what they say they are--and are not frowned upon by the Police--then I will give them every ounce of my energy and devotion and dedication.

If I don't hear from you, I will take it to mean that they are okay.

(You people are so busy, this letter probably won't get read, but at least I got it off my chest.)

LET ME REPEAT: I WOULD NEVER DO ANYTHING THAT THE FBI OR J. EDGAR HOOVER DIDN'T SANCTION.

But--if the leftists in the Govt. put a Communist at the head of the FBI--that of course, would be an entirely different story.

Well--please forgive this long letter. But this whole Satanic mess, makes many of us fear for our sanity--(which is what the Red's want--to break our will to win!!)

All I know, is that I will die fighting rather than meekly and passively submit to the most brutal tyrants the world has ever known.

(If I'm wrong in joining the SAC--I IMPLORE YOU TO LET ME KNOW, you, or the Sheriff's Dept., would be the only ones who could tell me what I've gotten myself into.)

If they ask me to break any laws--I'm afraid I will have to say no--then who's to say--they wouldn't have me marked as a traitor?

They, (the SAO) call themselves the "last line of defense against Communism." I thought it sounded good--since our Government is not allowed to protect us anymore--nor is the Police. All I'm trying to do is defend my family--myself, and all good loyal American's, including you of the FBI., in my small humble way.

Right now--I am under surveillance by the SAO, as they said I would be, for security reasons, if I joined. (Maybe I am also under surveillance by the Communists. Some mysterious guy, with sun glasses and sneaky look, has walked by here real slow periodically, with a scrutiny that is unmistakable, for months now!)

They may be perfectly okay, and my imagination and suspicion may well be working overtime. But I'm somewhat confused by this literature they sent me yesterday.

The way I see it, as I said, it's now impossible for anyone to walk a middle road, for those of us who want to make sure that "Freedom does not perish from the earth."--and indeed survive, but, alas, I'm repeating myself! What I am trying to say, in my round about way, (or explain) is my reason for going so far as to join this militant Counter-Revolution group. (I don't understand why Americans by the thousands--arn't doing the same thing!!!!)

If the Red's take over, I don't want to live anyway--so what have I got to lose????

GOD BLESS YOU,
WITH MUCH RESPECT AND GRATITUDE!

Donna Lee Hartley

Donna Lee Hartley

P.S.

Please let me know if I'm wrong by joining the SAO. ARE THEY ON YOUR SIDE????

*(later) Please excuse the grammatical errors--I was upset & not
--but I'm not used to typing.*

this letter (if indeed, I remain with the SAO - I will undergo strict discipline training - & will no doubt have to learn to cool my passionate emotions - [for the good of the Country] But - how can one not show high emotion & passion - when one loves, so much their glorious Native Land - and sees it being defiled, desecrated, & destroyed??!!

GOD HAVE MERCY ON AMERICA, & SAVE US.

It certainly, in my estimation, takes passion & emotion to willingly offer ones life - endeavoring to WIN a war.

Whether or not - I become actually actively involved in SAO - depends on some kind of answer either by you - or Sgt. Franklin [Vice + Intelligence -

Sheriff's Dept] (Came to this conclusion - after receiving this last packet of literature)

SAC, SAN DIEGO (4-00)

2/18/72

SUPERVISOR ANTHONY J. MALONEY, JR.

FIREARMS ACTS

Special Agents handling extremist matters should be particularly alert to reacquainting themselves with all of the criminal statutes involving gun law violations so as to be in a position to recognize and pursue such possible violations when they come to your attention during extremist matter investigations.

The review should include Bulets to Albany (all offices) dated 3/18/71 and 5/17/71 captioned "Firearms Acts" (located in 4-00-Serials 29 and 31), as well as Manual of Instructions, Volume III, Section 74, and the FBI Handbook, Part III, Section 55.

1 - 4-00
① - 157-2815
1 - 157-2928
1 - 157-00

AJM:mt
(4)

157-2815-25

SEARCHED _____	INDEXED _____
SERIALIZED _____	FILED _____
FBI - SAN DIEGO	

Chastain *ML*

TO:

DIVISION 4 - IRD

FILE SERVICES

PICKETT STREET

ATTN: _____

917

62-116395-1249X

2
enc.
65

JPL:emg 1/30/76

THE ATTORNEY GENERAL U.S. SENATE SELECT COMMITTEE
ON INTELLIGENCE MATTERS (SSC)

ReSSCreqs 1/8&9/76. Enclsd for ur appvl &
forwardng to SSC is memo prepared to effect
dlivery of ths materials. A copy of that memo
furnshd for ur records.

SSC Request 1/20/76
Item 2 (Re: Howard Berry Godfrey)
Volume IV

Access

Date prepared

2/24/71

Date received

2/9/71

Received from (name or symbol number)

[Redacted] *

Received by

SA Steven L. Christensen

Method of delivery (check appropriate blocks)

in person by telephone by mail orally recording device written by Informant

If orally furnished and reduced to writing by Agent:

Date

Date of Report

Dictated

2/19/71 to G. Ramsey

2/9/71

Transcribed

2/23/71

Date(s) of activity

Authenticated by Informant

2/24/71

2/8/71

Brief description of activity or material

Contact w/ Isaac Cantrell

File where original is located if not attached

* INDIVIDUALS DESIGNATED BY AN ASTERISK (*) ONLY ATTENDED A MEETING AND DID NOT ACTIVELY PARTICIPATE. VIOLENCE OR REVOLUTIONARY ACTIVITIES WERE NOT DISCUSSED.

Information recorded on a card index by _____ on date _____

Remarks:

157-1998 (MM)

170-286A-16

157-2224 (Cantrell)

~~157-91-3149~~ (DePugh) - 91-3149*

~~157-91-3149~~ (Walker Patrick Peyson) (or index) - 91-3149*

* indicates symbol number deleted

170-286A-76
Block Stamp

SEARCHED	INDEXED
SERIALIZED	FILED
FEB 26 1971	
FBI - SAN DIEGO	

On February 9, 1971
By JEROME

I contacted the mystery man last night at Denny's Restaurant and it turned out to be ISAAC CANTRELL. He told me that he previously lived in Arizona and because of some trouble or difficulty there, moved to Los Angeles, California.

He said he believed he had been followed to Los Angeles. He subsequently moved to the San Diego area and is now living in Alpine.

We talked about his recent arrest on charges of violating firearms laws and he said the charges against him have been dismissed. He said he thinks the local authorities are still watching him, and that they may try to arrest him again if they get the chance.

He said he still has most of his stuff for working on firearms but indicated that the articles which were confiscated at the time of his arrest had not been returned to him.

As an additional note of interest, he told me he had been in contact with BOB DE PUGH and WALTER PEYSON at Phoenix, Arizona, approximately three months before they were arrested.

I plan to proceed slowly in my contacts with CANTRELL as he may be a set-up for the local or state authorities.

Jerome

Date prepared

2/24/71

Date received

2/11/71

Received from (name or symbol number)

X

Received by

[Signature]

Method of delivery (check appropriate blocks)

in person by telephone by mail orally recording device written by Informant

If orally furnished and reduced to writing by Agent:

Date

Dictated 2/19/71 to G. Kamery

Transcribed 2/23/71

Authenticated by Informant 2/24/71

Date of Report

2/11/71

Date(s) of activity

2/10/71

Brief description of activity or material

Info re Domenico, Davis,
Centrell, NCEHP

File where original is located if not attached

100-15462

* INDIVIDUALS DESIGNATED BY AN ASTERISK (*) ONLY ATTENDED A MEETING AND DID NOT ACTIVELY PARTICIPATE. VIOLENCE OR REVOLUTIONARY ACTIVITIES WERE NOT DISCUSSED.

Information recorded on a card index by _____ on date _____

Remarks:

157-2178 (Domenick)
170-286A-77
100-14297 (Davis)
100-15356 (Hoover)
100-15462 (NCEHP)
100-14427 (MIC)

Block Stamp

170-286A-77
SEARCHED _____ INDEXED _____
SERIALIZED _____ FILED _____
FEB 26 1971
FBI - SAN DIEGO
[Signature]

EXPERIENCING

On February 11, 1971
By JEROME

The photograph of RONALD TIMOTHY DOMENICK is not familiar to me. However, I will scout around and see if I can find out something about him.

I was talking to SAM DAVIS yesterday. He told me he recently came close to killing a police officer and explained that he and GEORGE HOOVER were hauling a trunk full of machine guns in one of their cars when they were stopped because they had a bad headlight.

DAVIS said he got out to meet the officer and had a .45 caliber pistol under his belt on his back and a hand grenade in each pocket of his jacket. He said HOOVER, who stayed in the car, was covering him with a Thompson sub-machine gun. He said if the officer had tried to look in the car they probably would have had to kill him.

CANTRELL and I have set up a method whereby there will be a five minute period of time each week during which I can contact him at a specified telephone number.

Attached are some printed materials from the National Center for the Exploration of Human Potential. These items were obtained a while ago by the Minutement from the files of the Message Information Center.

Jerome

Registration Form

Name _____

Address _____

City _____

State _____

Zip _____

Fee is tax deductible

\$31 Per Person

\$55 Per Couple

\$20 For Full Time Students

Meals included.

20% reduction in program cost for Center Members

The National Center for the Exploration of Human Potential
180 El Paseo Grande, La Jolla, California 92037

NON-PROFIT ORGANIZATION
U.S. POSTAGE
PAID
SAN DIEGO, CALIFORNIA
PERMIT NUMBER 747

EXPERIENCING

THE FREEDOM, INTIMACY AND

ZEST OF A

MODEL COMMUNITY

November 20, 21, 22

TORREY PINES INN

La Jolla, California

National Center for the Exploration of
Human Potential

EXPERIENCING COMMUNITY THE TORI EXPERIENCE

The TORI community starts with several experiences designed to build a sense of community, and to deepen personal growth.

Stemming from these experiences, the community unfolds and emerges. Each member has an opportunity to participate in this process and to influence the unfolding in significant ways. The community becomes a powerful medium for personal change. Members have an opportunity to relate intensely and openly to many others in a variety of situations. They are free to try out new ways of being and doing. Each participant is responsible for his own learning, and has a variety of options and choices during the weekend. Each person, in a significant sense, creates his own experience and his own community environment.

The TORI experiences (trust, openness, realization, and interdependence) emerge from the community interaction. They are seen as central to the growth of the person as well as to the development of community. The basic TORI theory will be presented by Dr. Jack R. Gibb as it is applied to the building of a sense of community in classrooms, neighborhoods, congregations, families, and the total school or business system.

Sandra La Boon, who will be conducting the workshop, has worked with Dr. Gibb over the past two years in a wide variety of group

experiences. She has conducted groups with the Center, Y.M.C.A.'s of Los Angeles and San Diego and with the Methodist Church. She is currently conducting research with Dr. Gibb on the TORI theory.

DESIGN

The community is built upon 24 hours of experiences over a three-day period. Participants should plan to attend for all 24 hours. No observers will be admitted although participants will have freedom to participate in an experience or not. We start after dinner, 7:30 PM on Friday. The Experience ends 5:00 PM on Sunday. It is not necessary to stay over night at the Inn.

CLOTHING

The dress should be comfortable and informal, so you can sit on the floor and go barefooted or wear socks.

SCHEDULE

Friday night from 7:30 p.m. - 11:00 p.m.

Saturday from 9:00 a.m. - 11:00 p.m.

Sunday from 9:00 a.m. - 5:00 p.m.

MEALS

Meals are an integral part of the experience and participants should plan to have all meals with the group. There is no additional charge for meals.

AN UNUSUAL OPPORTUNITY FOR GROUP LEADERS

For the first time we will be providing a program to train leaders in conducting the TORI Community Experience.

In order to be eligible to take the leader training it will have been necessary for each potential leader to have experienced a complete TORI weekend.

The training will be in the evening November 22, 23, and 24th, 7:30 to 10:00 P.M. at the National Center 8080 El Paseo Grande, La Jolla, California.

Cost of the training is \$25.00.

Center news



OCTOBER, 1970

Mari Murdock, Editor
Bonnie Weber, Artist

TORI WEEKEND WITH SANDRA LA BOON
by Ann Sturgis

November 20, 21, and 22
Friday evening, Sat. & Sun.

This is an adventure in a community of high trust living. The experiences of the weekend are based on the theory formulated by Dr. Jack R. Gibb, his wife Lorraine, and associates. The program has been given for national conferences, staff and management of companies, college faculties, congregations, freshman orientation programs, high school student bodies, and other groups. Sandra La Boon has been working with Dr. Gibb for the past two years and doing research upon the effects of the TORI experience upon participants and their organizations. She is warm, charming, and competent as a leader.

WHAT CAN HAPPEN IN A TORI WEEKEND? Trust can emerge, chasing away a lot of vague anxieties and insecurities. You can get in touch with your freedom and self-determination. Experience an openness and sense your flow in life. You can explore your own feelings about touching and being touched. Become more aware of your own initiative. Shed the bondage of a role, become spontaneous. You may experience, as some participants have, transcendental or mystical experiences. Take part in a celebration. Recapture the pleasure of being alive and human.

For reservations or further information, contact the Center.

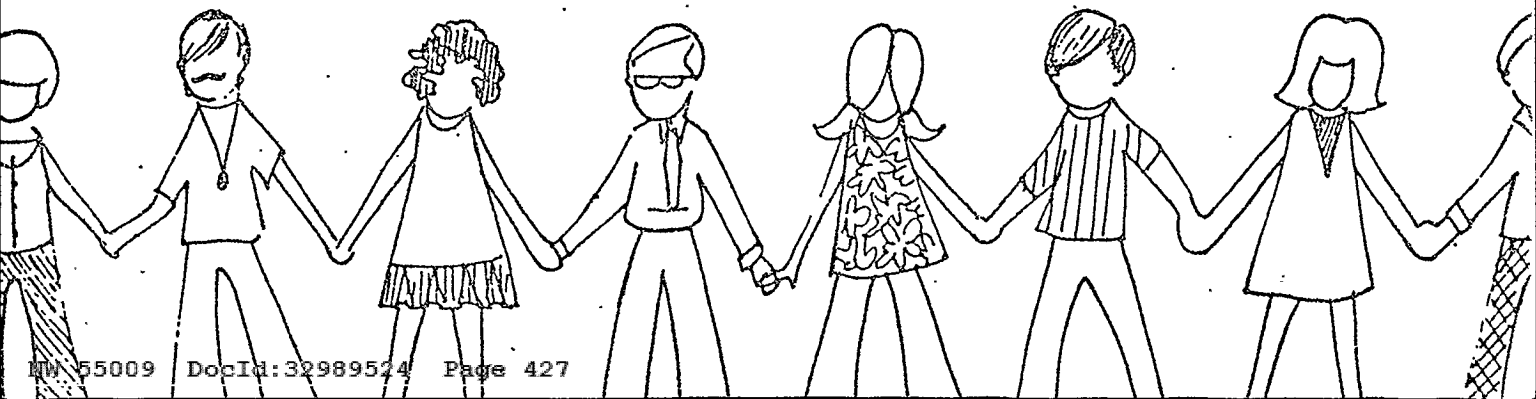

MODEL PROJECTS REPORT

Parent and Early Childhood--Three meetings have already been held with future meetings scheduled weekly. The last meeting was ecstatic and productive, breaking up after midnight. Contact Jan Hickman (454-5915) for information.

Senior Citizens--One meeting has already been held. Winnie Yee (273-4838) is coordinating temporarily, but we need a permanent coordinator.

Teen Program--Dee Thieda is coordinating. The first meeting was held October. For further information, contact the Center.

Parent-Teen Committee--No meetings have yet been held. A coordinator is needed. If interested, please call Al Lewis at the Center.

Business and Industry--Dave Perlis and Jay Singh are coordinating. One meeting has been held and Dave and Jay are eager to involve more people. Contact the Center, or try Jay at home, 488-4128.

Churches--A committee is being formed to work with the churches. Several ministers have indicated interest. Please contact Al Lewis for further information.

Women's Program--Mari Murdock--I am interested in contacting anyone who is interested in working on the development of a pilot program aimed at helping women move away from the sex-role stereotype and into a greater realization of our own identity, strength and creativity as human beings. I have contacts with the Women's Studies Program at San Diego State College and a rather comprehensive bibliography of the literature in this field which may be of some use. I'd like to begin meeting with a group of female members and friends of the Center as a first step in the effort to identify what points we'd like to cover with the pilot program. While the initial rap sessions may be limited to women only, men are welcome at the committee meetings. If interested, please give me a call at home (583-1563) or leave your name with someone at the Center.

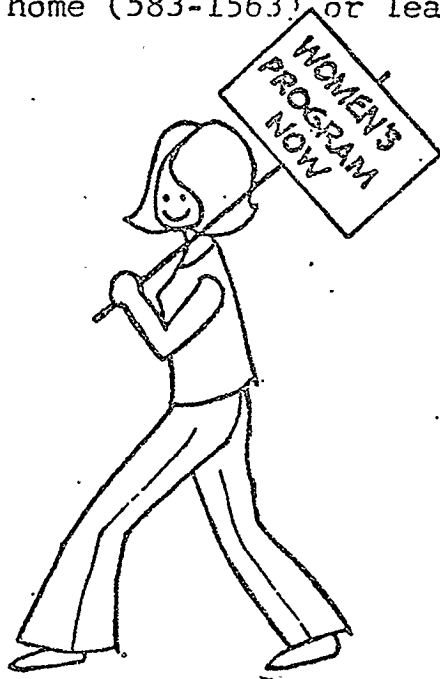

If you are interested in any of these committees, please contact Al Lewis or the respective coordinators.

Dear Fellow Member:

As your new membership director I would like to tell you how excited I am about the exciting things that are happening at the National Center. But, before I go into that, let me tell you how I became associated with it. A DPP on September 26 and 27, led by Al Lewis and Winnie Yee, convinced me of what I had increasingly come to believe over the last two years--the ultimate beauty in the world is the human being--you and me--each of raw material for the most beautiful works that can possibly be created.

I came to the Harvard Business School from New Delhi, India, in May, with the intention of acquiring the skills to go and capture for myself treasures of the outside world. Oh! I was determined to be relentless in my seeking, and if someone got hurt, or had to be hurt, it was going to be all in the line of business.

Now, having gotten my MBA and having started work on my Ph.D. in Leadership and Human Behavior at USIU, I'm realizing that there is something more important for me to do, and this is to strive to tap more of my own inner, infinite potentialities, to strive for growth as a person, to make myself a beautiful work of art. The real treasure lies within me, not outside of me. Well, I'm embarked on this journey--on this adventure in becoming more of a person.

But I have realized too, that I can do this only with the help of other people. I can only actualize my infinite potentialities by helping other people actualize theirs. And so, I accepted the responsibility that Al Lewis requested me to take up--and I have launched the 1970 Fall Membership Drive. My goal is to double our present membership, i.e., to increase the number of Participating Members by at least 240 by December, 1970. That's the very least the Center must do. That's the smallest increase my conscience will allow me. Our long range goal is to reach out to the millions in San Diego, in the U.S.A., and elsewhere around the world.

And in this, I need your help. Will you join with me in this program to reach out to more people? I would like to suggest this to each member. Reach out to one person in each of the last three months of 1970 and ask him to become a Participating Member of the National Center. Also, please renew your own membership if it's about to expire. Al and I have developed a list of privileges for members (see articles on membership and Esalen tapes), but these are all insignificant relative to the inner joy of helping people to become everything they are meant to be.

Two other important programs, the Community Action Program and the Model Projects Program, have been launched. The National Center is going forward. This is due to you and other members like yourself. Now I'm asking more of you--to help us reach our objective of at least another 240 members by December, 1970.

Thanks, and Love to all of you.

Jay Singh
Membership Director

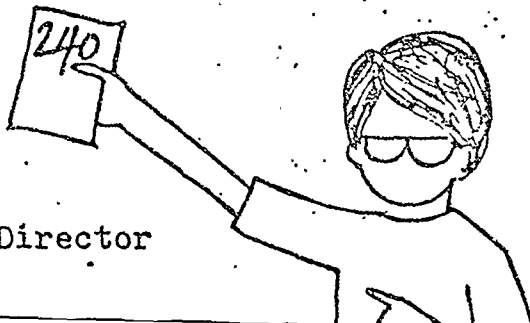

MEMBERSHIP INFORMATION

The National Center offers the following membership opportunities:

TYPE OF MEMBERSHIP	COST	ADVANTAGES
DONOR	\$1000 or more per year	1. All advantages of Participating Member 2. 12 scholarships (to any \$33.00 program)
SPONSORING	\$500 or more per year	1. All advantages of Participating Member 2. 6 scholarships
SUSTAINING	\$100 or more per year	1. All advantages of Participating Member 2. 2 scholarships
PARTICIPATING	(a) FAMILY \$40.00/year	1. All advantages of mailing list membership
	(b) REGULAR \$25.00/year	2. Borrowing privileges from Center cassette tape library Human Potentialities book library
	(c) FULL-TIME STUDENT \$15.00/year	3. All Center programs available to you at 20% discount 4. Opportunity to participate in Center Model Projects Program 5. Opportunity to actualize your own potential and help others actualize theirs through other activities determined by you and the Center.
MAILING LIST	\$3.00 per year	1. 2 page BULLETIN of behavioral science research findings to aid your personal growth 2. Newsletter 3. Schedule of programs 4. Information on all growth centers and human potentialities programs upon request

But, above all, the opportunity to work with us, to join us in reaching out to more people in San Diego, the United States, and beyond, is the MOST IMPORTANT ADVANTAGE.

TAPES FROM ESALEN

The following tapes have been ordered from Esalen. They should be available for use of members only by the middle of November, 1970. The tapes will be available on a library-loan basis, the details of which are being finalized.

SURVEY AND BACKGROUND OF HUMAN POTENTIAL MOVEMENT

ABRAHAM MASLOW: Farther Reaches of Human Nature	2 hrs.
CARL ROGERS: Intensive Group Experience	1 hr.
RICHARD MARSH: Beyond Games	1 hr.
WILSON VAN DUSEN: Interview by Michael Murphy	2 hrs.
GEORGE LEONARD: Steps Toward Utopia	1 hr.
MICHAEL MURPHY: From Dream to Reality	1 hr.
WILLIAM SCHUTA: Theory for Esalen & Microlab Experience	2 hrs.
FREDERICK S. PERLS: Dream Theory & Demonstration	1 hr.
FREDERICK H. STOLLER: Interview by Connie Goldman	1 hr.
EDWARD MAUPIN: Guided Meditation in Body Awareness	2 hrs.
ALAN WATTS: Divine Madness	2 hrs.
JOSEPH CAMPBELL: Freud, Jung, & Kundalini Yoga	1 hr.
SIDNEY JOURARD: Human Uses of Behavioral Research	1 hr.
ROBERT GERARD: Psychosynthesis	2 hrs.
VIRGINIA SATIR: Family Communication & Growth	1 hr.
DONALD JACKSON: New Methods of Working with the Family	1 hr.
JACK & LORRANINE GIBB: The Emergent Group	2 hrs.
17 titles	24 hours

BROAD SCOPE OF THE FUTURE & CAPACITY FOR HUMAN GROWTH

USA 2000: THREE ALTERNATIVE VIEWS: Rogers, Watts, Kahn	2 hrs.
GEORGE LEONARD: Predictions for Education	1 hr.
MICHAEL MURPHY: A Survey of Current Programs	1 hr.
GEORGE STEINER: Critical Comment	2 hrs.
SUZUKI ROSHI: Teachings & Disciplines of Zen	2 hrs.
ALAN WATTS: The Diamond Way	1 hr.
JOSEPH CAMPBELL & HUSTON SMITH: Tibet	1 hr.
R. D. LAING: Introductory Tape on Sanity	2 hrs.
JOHN PERRY: Journey into Archetypal Myth	1 hr.
STANISLAV GROF: LSD Therapy	1 hr.
POETRY OF MADNESS: Perry, Watts, Naranjo, Ginsberg	2 hrs.
HARVEY COX: Religion in the 21st Century	2 hrs.
ABRAHAM MASLOW: Psychology of Religious Awareness	1 hr.
WILLIAM SCHUTZ: A Guided Fantasy Demonstration	1 hr.
DANE RUDHYAR & CLAUDIO NARANJO: Symbols of Unfoldment	2 hrs.
JOHN C. LILLY: Learning from the Dolphins	2 hrs.
16 titles	24 hours

NEEDS AND WANTS

Do you have any of the following lying around collecting dust, or do you know of anyone who might be persuaded to part with their treasure in the service of a good cause? We still need

filing cabinets (one legal size and one regular)
vertical and horizontal files
a small desk
sturdy table for typewriter
books for Human Potentialities Library
New Members

Anyone willing to donate 25 square yards of carpeting for the group room at the Center?

Face lifting at the Center offices is proceeding rapidly. Have you seen the new table and shelves built for us by Al Attig of San Diego Product Engineer? We've decided on a color scheme and are looking for people willing to make drapes and help with painting. If you have skills and/or enthusiasm, please contact Brax Millard (277-6442). Brax is our "artist", also a gardener and landscape designer by profession who is looking for additional free lance work. The Center's new bulletin board and the DPP posters are samples of his creativity and competence.

We still need a large house or equivalent, preferably in the San Diego area, which can be made available for Center residential programs. Suggestions, offers or questions should be directed to Audrey or Al at the Center.

REPORT ON FUNDING PROPOSAL -- Len Chase

An NCEHP preliminary resume was prepared. It contains a description of the Center's programs and plans, organization and cost projection for a three year period. Copies are being made available to certain agencies and foundations. By this means, funding for the support of current and on-going programs is being solicited. Efforts are now being turned toward the expansion of resume data and the start of special purpose funding proposals.

MESSAGE TO DPP LEADERS

Leaders who have been trained by Dr. Otto still need to lead several practicum before their training is considered complete. Any leader who wants additional practicum experiences, please contact Winnie Yee at home (273-4838) or at the Center.

REPORT ON PRACTICUM WEEKENDS -- Winnie Yee

Since July, a total of 50 leaders trained from the Summer Institute and previous training sessions have led practicum (training) weekends. Approximately 200 individuals from the San Diego community have participated in these weekends. They come from all walks of life with ages ranging from 15 to 60. Feedback indicates that these practicums have been growth experiences for both leaders and participants. It is anticipated that leaders undergoing training will have an opportunity to lead every 4-6 weeks with a greater number of the participants coming from the various colleges in the area.

Date prepared

2/24/71

Date received

2/12/71

Received from (name or symbol number)

[Redacted] *

Received by

SA Steven L. Christense

Method of delivery (check appropriate blocks)

in person by telephone by mail orally recording device written by Informant

If orally furnished and reduced to writing by Agent:

Date

Date of Report

2/12/71

Dictated

2/23/71 to V. Wilson

Date(s) of activity

Week ending
2/12/71

Transcribed

2/23/71

Authenticated by Informant

2/24/71

Brief description of activity or material

Info re William Cantrell

File where original is located if not attached

* INDIVIDUALS DESIGNATED BY AN ASTERISK (*) ONLY ATTENDED A MEETING AND DID NOT ACTIVELY PARTICIPATE. VIOLENCE OR REVOLUTIONARY ACTIVITIES WERE NOT DISCUSSED.

Information recorded on a card index by _____ on date _____

Remarks:

138-2224 (Isaac Cantrell)

170-286A-76

170-286A-78
Block Stamp

SEARCHED INDEXED
SERIALIZED FILED
FEB 25 1971
FBI - SAN DIEGO
[Handwritten signature]

February ¹² ~~11~~, 1971
BY JEROME

I have made arrangements whereby I can contact ISAAC CANTRELL at a pay telephone during a five minute period of time once a week. The next scheduled contact period is for the middle of next week. He wants to be contacted at that time as he wants to have some phony identification made up for him. He feels he needs this extra identification in order to hide out or conceal himself in the event it looks as though the authorities are going to try to bust him again.

He apparently is still capable of producing his homemade machine guns, and there is some indication he may be willing to trade a completed model of this machine gun for the phoney identification.

Jerome

Date prepared

2/24/71

Date received

2/18/71

Received from (name or symbol number)

[Redacted] *

Received by

SA Steven L. Christensen

Method of delivery (check appropriate blocks)

in person

by telephone

by mail

orally

recording device

written by Informant

Orally furnished and reduced to writing by agent:

Date

Dictated 2/19/71 to G. Kenning

Date of Report

2/18/71

Transcribed 2/23/71

Date(s) of activity

2/17/71

Authenticated by Informant 2/24/71

Brief description of activity or material

SAC rally

File where original is located if not attached

100-13847

INDIVIDUALS DESIGNATED BY AN ASTERISK (*) ONLY ATTENDED A MEETING AND DID NOT ACTIVELY PARTICIPATE. VIOLENCE OR REVOLUTIONARY ACTIVITIES WERE NOT DISCUSSED.

Information recorded on a card index by _____ on date _____

Remarks:

157-1798 (MAM)

170-286A-14

100-13847 (SAC)

100-14495 (Alan Stancliff)

100-14646 (Connie Stancliff)

100-14485 (Williams)

100-15507 (Nystrom)

100- (Dr. George Abbott)

100-14297 (Davis)

100-14892 (MDM)

100-11836 (YSA)

Index: Peoples Peace Treaty (100-13847)

Open Deal

Block Stamp

SEARCHED INDEXED
SERIALIZED FILED
FEB 26 1971
FBI - SAN DIEGO

100-286A-79

On February 18, 1971
By JEROME

I was present at the SMC sponsored rally yesterday. It looked as though 250 persons were present. Most of the well known radical names were present such as ALAN STANCLIFF, CONNIE STANCLIFF, BILL WILLIAMS, B. J. MYSTROM, DR. GEORGE ABBOTT and others.

Nothing spectacular happened, and I was unable to listed to the speakers as I was forced to leave early. This was because B. J. BYSTROM, who knows me very well, was circulating around and I did not want to be recognized.

I was talking to SAM DAVIS last night and he told me an interesting thing. He said that some of the Minutement have discovered that their fingerprints can be temporarily disfigured or obliterated simply by spraying them with this new clear spray bandage or by rubbing white glue like Elmer's Glue on them.

Attached are the leaflets I obtained yesterday at the rally.

Jerome

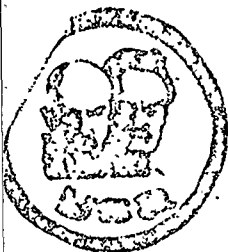

CLASSES IN REVOLUTIONARY SOCIALISM

IF YOU ARE CONCERNED ABOUT THE STRUGGLES GOING ON IN THE WORLD TODAY AND IN WAYS TO HELP THESE STRUGGLES CULMINATE IN A BETTER SOCIETY—COME TO THE INFORMAL CLASSES SPONSORED BY THE YOUNG SOCIALIST ALLIANCE. WE OFFER A MARXIST ANALYSIS OF WHAT'S HAPPENING TODAY AND A CONCRETE PROGRAM FOR CHANGING SOCIETY.

- Feb. 10 REVOLUTION IN THE UNITED STATES?
Reading: How to Make a Revolution in the U.S. by Peter Camejo
- Feb. 18 THE STATE AND REVOLUTION
Reading: The Marxist Theory of the State by Ernest Mandel.
- Feb. 24 THE STRUGGLE FOR BLACK LIBERATION
Reading: Transitional Program for Black Liberation
How a Minority Can Change Society by George Breitman
- Mar. 3 WHAT IS CAPITALISM?
Reading: The Teachings of Karl Marx by V.I. Lenin
- Mar. 10 THE REVOLUTIONARY POTENTIAL OF FEMINISM
Reading: Problems of Women's Liberation by Evelyn Reed
- Mar. 17 THE CHICANO LIBERATION STRUGGLE
Reading: La Raza! Why Chicano Party? Why Chicano Studies?
- Mar. 24 HOW TO DEFEND THE VIETNAMESE REVOLUTION
Reading: War and Revolution in Vietnam by Doug Jenness
Liberalism, Ultraleftism and Mass Action by Camejo
- Mar. 31 SOCIALISM AND THE POTENTIAL OF HUMAN BEINGS
Reading: Socialism and Man by Che Guevara

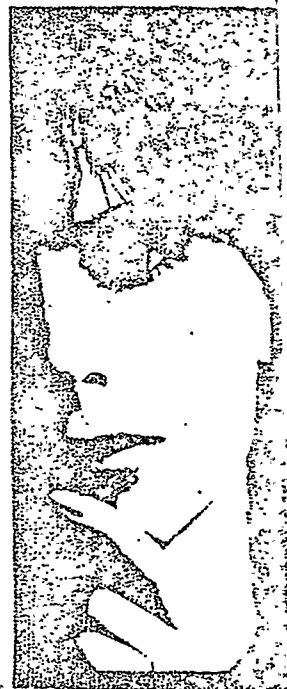

WEDNESDAYS at 7:30 p.m.
San Diego State College
Aztec Center, Room N
given by the



OZZIE NEVER HAS A NICE DAY...

Some judge in Oregon gave Ozzie Osborn a choice:

"DO YOUR TIME IN THE JOINT
OR DO 4 YEARS IN THE MILITARY."

Ozzie thought he might be getting a good deal...
A chance to make himself into something [a man]

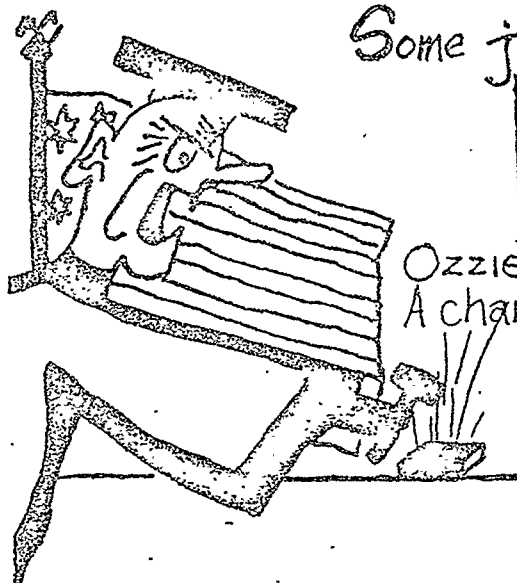

When Ozzie joined the Marine Corps, he looked around.
He saw that instead of becoming a man,
he was becoming a robot...
trained to kill poor people...
trained to be cannon fodder...

Ozzie hated the corps.
He and 15 other GI's
skipped out on their company
in a slave revolt. Ozzie was
a delinquent just like
back home.

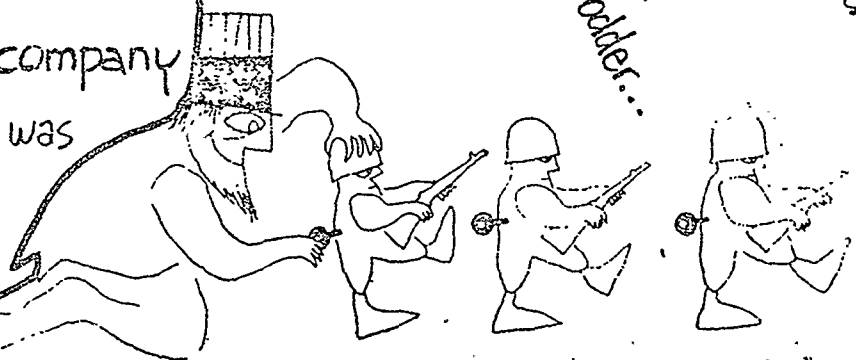

But this time he didn't feel like he was
all wrong and they were all right.
He felt strong and joined up with other GI's
who felt the way he did about the service.

Being inside the Corps is hard enough. Fighting it from the inside takes a super-together-head.

So Ozzie took a vacation in Kanada to get ready before

he came back again to join other GI's in resisting the military and the War in Asia.

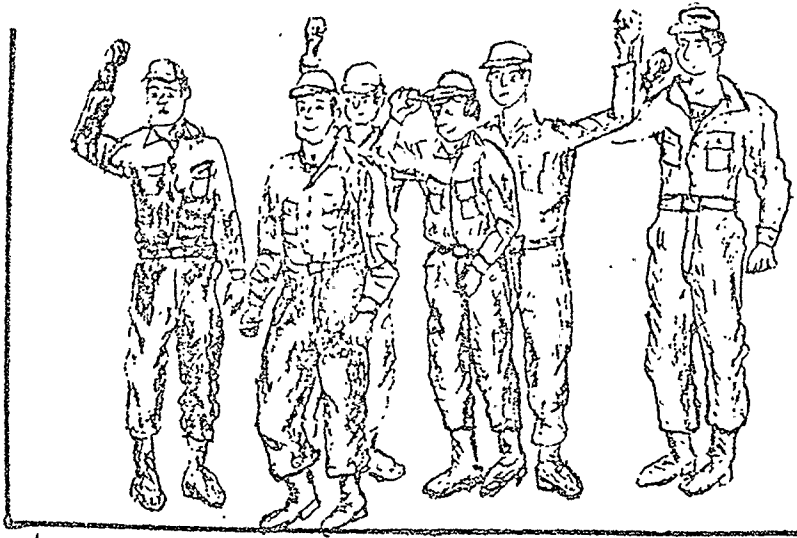

When he tried to return Ozzie was busted. But he was set

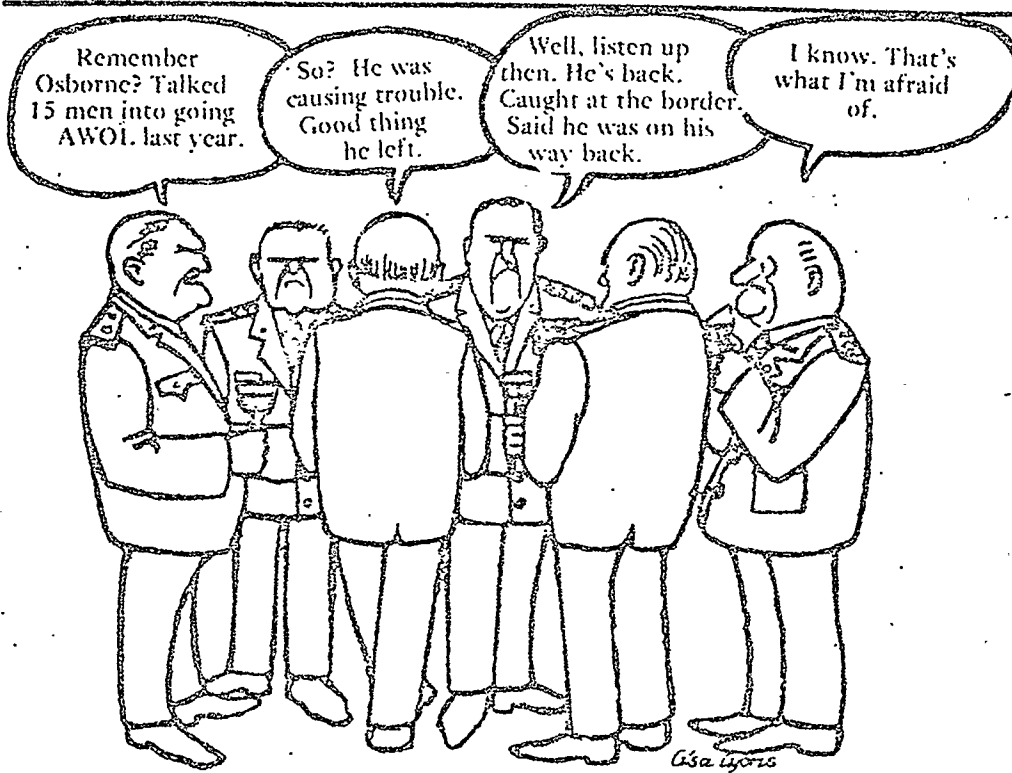

free to await his court-martial for Unauthorized Absence. You see, the lifers in charge had misplaced his records... When Ozzie's file caught up with him, they found out what

his political beliefs were; put him in the brig and charged him with desertion. Ozzie was shafted. He now faces a General Court

FIND OUT HOW YOU CAN HELP IMPLEMENT THIS TREATY AND BRING AN END TO THE WAR

for further information call: from 10 to 4 p.m. call 286-6460

from 5 to 7 p.m. call 291-9487

Substantive parts of the motion on the People's Peace Treaty

We move that this Association (organization, institution) endorse a people's treaty with the people of Viet Nam,

The President of the Association (organization, institution) shall appoint a commission with a mandate

(A) to communicate this motion to the Vietnamese people

(B) to engage in discussions with representatives of the Democratic Republic of Viet Nam, the Provisional Revolutionary Government, other popular forces, and academic colleagues seeking peace and independence in Viet Nam in order to engage academic cooperation and exchange, and

(C) to study and recommend ways and means to withdraw the resources of this association (organization, institution) from further support from this war.

Prior to May 1, 1971 (a year and a day after the U.S. invasion of Cambodia) this commission shall report to the membership on the progress of its work and of proposals for further action implementing the motion.

Explanatory Material

In opinion polls and in direct tests on the ballot, most recently in Detroit, American people have shown themselves to favor immediate and total withdrawal from Viet Nam.

Furthermore, the Nixon Administration, aware of this growing majority, has consistently claimed to be ending the war. But the facts are disheartening. Two years

passed. American bombing of Laos has sharply increased. American troops

invaded Cambodia and then left the ARVN to continue open warfare in that

usually quiet country, with massive air support from U.S. forces. The devastation of South Viet Nam has continued. And playing upon the anxiety of Americans

At the prisoners held in the North, the U.S. Government has even increased the bombing of North Viet Nam, as well as initiating commando raids. Bombs with destructive power two and one-half times that of the Hiroshima atom bomb are dropped on Viet Nam every week. Apparently the Administration has defined "ending the war" as lowering the level of American battle casualties and the number of American ground troops in Viet Nam to a point that the American people will accept. But this definition permits the indefinite extension of suffering and destruction in Indochina brought by American aerial bombardment and other technology, and ground fighting by Asian mercenaries and conscripts.

At the same time the Nixon Administration has misrepresented the highly volatile political developments in the U.S. - held cities of South Viet Nam, where there has been rising and open opposition to the Thieu-Ky-Kiem regime and to the American presence, by students, war veterans, women, workers, intellectuals, journalists, Buddhists and others. These groups are openly willing to communicate with the NLF, and to enter into a coalition with the Provisional Revolutionary Govt. of South Viet Nam (PRG)

For that reason it is urgent that the PRG proposal (Paris. Sept. 17, 1970) receive fair consideration. It sets forth the following principles as the basis for a just and honorable peace: (1) the total withdrawal of all U.S. military forces from Viet Nam by a date to be specified by the U.S. - perhaps June 30, 1971, as in the Hatfield - McGovern amendment; (2) total withdrawal of all U.S. military and economic support of the Thieu-Ky-Kiem regime; (3) total non-intervention by the U.S. in the internal political affairs of Viet Nam. When these conditions are met the Vietnamese will (1) form a Provisional Coalition Government representing all independent and democratic forces and hold free general elections in all of S. Viet Nam; (2) release immediately all captured soldiers and political prisoners; and (3) refrain from attacking U.S. forces in the process of withdrawal.

The U.S. Government has not taken these steps, nor has it even taken the proposals seriously, so far as anyone knows. The people of Viet Nam and the people of the U.S. both want U.S. withdrawal; with the U.S. Government preventing it, it seems necessary for citizens and for groups to cease depending on the Government and to attempt direct contact with the Vietnamese. The endorsement of the People's Peace Treaty, as proposed in this motion, is the natural way to proceed toward that end.

Date prepared

2/24/71

Date received

2/18/71

Received from (name or symbol number)

[Redacted] X

Received by

SA Steven L. Christen

Method of delivery (check appropriate blocks)

in person by telephone by mail orally recording device written by Informant

If orally furnished and reduced to writing by Agent: Date

Date of Report

Dictated

2/19/71 to G. Ramsey

2/18/71

Date(s) of activity

Transcribed

2/23/71

2/17/71

Authenticated by Informant

2/24/71

Brief description of activity or material

Info re MM activities

File where original is located if not attached

* INDIVIDUALS DESIGNATED BY AN ASTERISK (*) ONLY ATTENDED A MEETING AND DID NOT ACTIVELY PARTICIPATE. VIOLENCE OR REVOLUTIONARY ACTIVITIES WERE NOT DISCUSSED.

Information recorded on a card index by _____ on date _____

Remarks:

- 157-1798 (MM)
- 170-286A-1
- 100-14297 (Oasis)
- 100-14364 (James Poto)
- 100-91-3149 (De Pugh)
- 100-14015 (Houghton)
- 100-14293 (Clay)
- 157-2224 (Centrell)
- 3-Phoenix
 - (1- Eu Moore)
 - (1- James Poto)

Index: Eu Moore

Thomas H. Deuzain
 1 copy of MM letter to go in 157-1798
 1 copy of MM letter to be kept in info man's file

Block Stamp

SEARCHED _____ INDEXED _____
 SERIALIZED _____ FILED _____
 FEB 26 1971
 FBI - SAN DIEGO
 170-286A-80

On February 18, 1971
By JEROME

Yesterday I checked the Minutemen Post Office Box in Spring Valley and found an answer to the letter we sent to the new Minutement group in Elgin, Illinois. The envelope was post marked February 8, 1971, and so has probably been in the Post Office Box for several days. The contents were wrapped in true Minutement fashion and copies are attached. I will have to have the original back for future business.

I showed the letter to SAM DAVIS last night. He was fascinated and excited by the letter and immediately called JIM POTO who is back in town from Phoenix, Arizona. POTO, in turn, is suppose to have tried to make arrangements for myself, POTO, and DAVIS to contact EV MOORE, Saturday, February 20, 1971, at the Gun Show in Yuma, Arizona.

MOORE, who resides in Phoenix, is suppose to be a big Minutemen leader who was close up under DE PUGH. He may possibly have been the counter part of TROY HOUGHTON which would have made him the regional coordinator of the Minutemen organization in Arizona. He is said to have some excellent contacts on the east coast.

If it is not possible for us to meet at Yuma, we will then call on MOORE at Phoenix some time in the next couple of weeks.

POTO, who I understand just barely returned from Arizona, has advised that MOORE has been wanting to make some contacts in the San Diego area. According to POTO, possible reasons for this would be that ~~MOORE~~ MOORE is tied up with the new group at Elgin, Illinois, and does not want the DE PUGH family to regain control of the organization. Furthermore, it does not appear that the new Minutement group has a regional coordinator for the Southern California area at this time and MOORE may be wanting to find someone to nominate.

Jerome

On February 18, 1971
By JEROME

I understand from talking to SAM DAVIS that we will have access to a printing press large enough to print full size newspapers. This press apparently belongs to BILL CLAY and is the one which was stored in DAVIS' garage for a long time. I do not know where it is now, but POTO claims to know of a secure garage which we can rent for \$6 a month to set the press up in and begin printing. We will see what happens.

I will contact SAM DAVIS again to night before leaving for the Yuma Gun Show. I am suppose to see ISAAC CANTRELL at the Denny's Restaurant in El Cajon at 7:00 p.m., on February 22, 1971.

Jerome

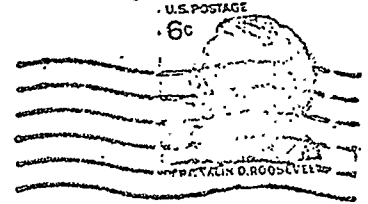

Occupant
P.O.Box 76
Spring Valley, Calif. 92077

FOR LOVE OF COUNTRY

National Leaders Praise V.F.W.'s Dedication To America

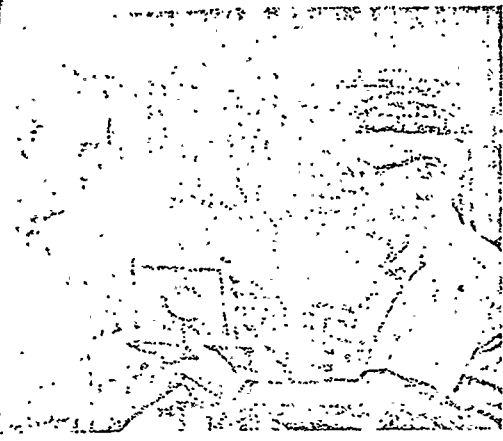

Vice President Agnew admires the V.F.W. Americanism Award presented to him by Commander-in-Chief Gallagher on behalf of the organization. (E-7)

A SERIES OF SPEAKERS representing the nation's top leadership appeared at the 71st National Convention of the V.F.W. at the Fontainebleau Hotel in Miami Beach, Fla., a reflection of the organization's stature.

Heading the list was Vice President Spiro T. Agnew who called for the V.F.W.'s assistance in defeating the McGovern-Hatfield Amendment that would hasten withdrawal of American troops from Indochina.

Sen. Alan Cranston (Calif.), Chairman of the Senate's Subcommittee on Veterans Affairs, explained the need for increased funds for the VA to operate its system of 166 hospitals.

Donald E. Johnson, Administrator of Veterans Affairs, praised the V.F.W. for its role in urging that veterans benefits be increased and related the strides being made by the VA in caring for the nation's war wounded. (See page 22 for additional details on speeches of Sen. Cranston and Johnson)

Neil Armstrong, recipient of the V.F.W. Space Award, said that "I am no gardener and placing the Flag on the moon was the first thing I have successfully planted."

Armstrong was the first human to walk on the moon.

Kansas City, Mo., Police Chief Clarence M. Kelley, who received the J. Edgar Hoover Gold Medal Award at the Distinguished Guests Banquet Aug. 17, pledged that police would stand at the side of the V.F.W. in protecting the United States.

"Thousands of officers sometimes face the withering fire of assassins," Kelley said. "Some are subjected to taunts and derision and are tested as few are. We accept a changing society, but our forbearance does not extend to treason or revolution.

"We won't stand by idly and let our society crumble from apathy and pernicious permissiveness. We are going to maintain a posture of dignity and protect this matchless land.

"We in law enforcement will be right beside you in the V.F.W. in protecting our beloved country."

Kelley said he accepted the award "not for myself but for the thousands of fine officers who dedicate their lives for peace and tranquility."

Peter J. Brennan, president of the New York Building and Construction Trades Council—one of the "hard hats"—was presented the Gold Medal of Merit.

In accepting the Award, Brennan said the march of the "hard hats" in New York last May "had the support of many other unions and just plain Americans.

"America will still be the greatest country in the world, despite our weaknesses."

Brennan said that the New York parade, which won worldwide attention, consisted of 240,000 persons in downtown Manhattan, while 500,000 watched.

Another New York labor leader who was honored with a Gold Medal Award was Charles Johnson, Jr., president emeritus of the

Carpenters District Council there.

"I cherish this honor above all the others I have received," he said. "When I read what was going on and the way some of our misguided youths had taken to the streets, I thought the average American was too complacent and we should do something.

"Those of us who were born under that Flag and will die under it bought every Flag in New York—50,000 of them—for our demonstration."

Johnson said the right of dissent "does not give anyone in this land the right to disgrace the national emblem, the American Flag."

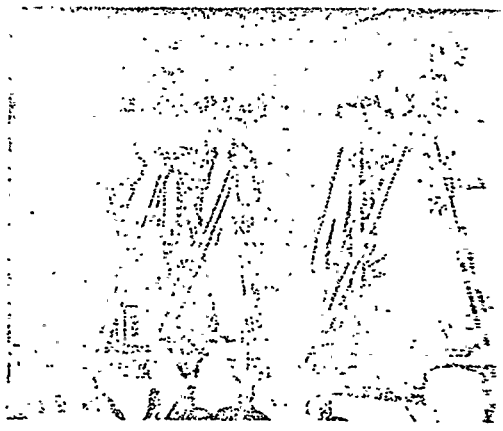

A battery of TV cameramen and newsmen were on hand for the Joint Opening Session. (JO-5)

When it was pointed out that Johnson had recently undergone heart surgery, he said "I would have walked here to receive this award."

Harold Russell, a disabled veteran of World War II and now chairman of the President's Committee on Employment of the Handicapped, presented Commander-in-Chief Raymond A. Gallagher with a citation from President Richard M. Nixon for the V.F.W.'s work on behalf of

(Continued on next page)

Mr. Jerry Moran
P.O.Box 76
Spring Valley, California.
92007

"MINUTEMEN"

P.O. BOX 896
ELGIN, ILLINOIS



February 8, 1971

Mr. Jerry Morgan
P.O. Box 76
Spring Valley, California.

Dear Mr Morgan;

We are most happy to hear from you and to find out that there are still some loyal members left in the San Diego area. We are the same organization minus the family of Bob Depugh and a few of the parasites who moved in on the old National headquarters at Norborne. So there is nothing to do really other than pick up where you left off and continue to work along our original goals.

We have had to increase security somewhat but not too much I hope to prevent us meeting some time in the future. I enclose a february bulletin for your files, Keep us informed as to the situation in your area.

Yours for America,

Tom DeMain

Thomas H. DeMain,
Secretary, National
Coordinating Center.

'MINUTEMEN'

P.O. BOX 896
ELGIN, ILLINOIS

JANUARY BULLETIN



A new year is upon us and there is much to report both good and bad concerning our struggle for a free America.

We will dwell shortly on the bad news first: Many of you have inquired about the fate of Thomas K. Stewart who has been indicted on several counts of Armed Robbery stemming from a series of very successful raids against the Socialist Worker's Party and The Young Socialist Alliance. The trials on all these charges are still pending and Mr. Stewart is out on \$30,000.00 bond at this time. The arrangements of legal council and tactics have kept a number of the staff here at the National Coordinating Center busy for quite some time. The cost of all this as you can well imagine has been very high, but it is our sworn duty to do all we can for Patriots such as Tom Stewart. As for more information about the case, the legal aspects are better if we make no public comment at this time.

Suffice it to say that the cases are heavy on our minds at this time.

The good news is somewhat more extensive, and is as follows:

1. The recruiting drive up and down the east coast is going very well and we will soon be over our goals there.
2. The reorganization of the regions is nearing completion with only several Regional directors left to be appointed.
3. The printing and reprinting of material is proceeding at a slow but steady pace.

As of this time the two most important considerations we have are security and recruiting. We urge all members to try and finish their training Phase as fast as possible, but for the interim we will enclose as part of this Bulletin a copy of Practical Security measures which we feel all members should read and put into practice as soon as possible.

The full report on the S. D. S. Convention which was held in Chicago on December 27th through December 30th. This extensive report will be available to all members for the cost of printing alone.

ne who wishes to event identification as a member of this organization should use the use of checks or postal money orders. In modern banking practice all checks are filmed and such records are kept for years. Ordinary cash is the best thing to send because the risk of a small financial loss in the mail is much less than the possible loss of your life when the communists take complete control.

2. Use deceptive measures. Subscribe to one or more left-wing periodicals or get on the mailing list of some 'peace movement'. This will keep the postal inspectors guessing as to which side you are really on. See the December issue of On Target for names and addresses of many left-wing organizations or write to National Headquarters for this information. We are doing this our members can be of great assistance in searching this left-wing literature for names and addresses of fellow travelers and forwarding this information for our Central Intelligence files. We desperately need people to assist in this work. Please inquire as to detailed instructions for such activity.

3. Always use two envelopes in sending mail to any patriotic organization or to any other member of our organization. Do not put a return address on the outer envelope. Put your return address on the inside envelope with the words, "Return postage guaranteed".

4. Place some opaque material such as tin foil, carbon paper, etc. between the inner and outer envelopes to prevent your mail from being read by infra-red cameras.

5. Send all letters from corner mail boxes or from post offices where you are not known.

6. Be careful in the use of the telephone. Avoid telephone calls to National Headquarters or to known members of the organization as much as possible.

7. Prepare telephone codes ahead of time for future protection.

8. In recruiting new members always learn as much as you can about the prospective recruit and make sure he is not an infiltrator before you identify yourself as a member of the organization.

9. Members of the organization in each area should be divided into four groups.

A. Those who have been identified publicly or by law enforcement agencies as members of the Minutemen.

B. Those persons not known as members of this organization but who are generally known as being patriots.

C. Those persons who have kept their political beliefs hidden.

D. Members who profess to be liberal for the purpose of infiltrating enemy organizations.

All members should be very careful in making contact with persons in a different category than themselves. For example, people in Class D should be very secret in their contacts and communications with persons of Class A or Class B. Each member must respect the security of every other member. Do not, under any circumstances, identify one member of the organization even to other members without his expressed permission on each and every occasion.

10. Avoid loose talk. Do not discuss organizational plans in public places where you

could be overheard. Do not even hint at such a discussion in the presence of non-member.

Do not write patriotic letters to newspapers or magazines under your own name. To do so achieves very little except to identify you to the enemy.

12. If you are already known as a patriot, or as a member of this organization you may find it advisable to spread the rumor that you have become disillusioned with the right-wing or for you to pretend a gradual loss of interest.
13. Classify your various members addresses, your communications and your other activities as 'top secret', 'secret' or 'restricted'. Use your most secret lines of communication only for the most important messages rather than flooding them with unimportant material.
14. Demand obedience to all security measures from all members. Persistent disregard for security measures should be cause for disciplinary action.
15. Check your lines of communication from time to time by sending phoney messages to make certain they are not intercepted.
16. Change mail drops, meeting places, etc. frequently.
17. Prepare secret rendezvous points, mail drops, etc. now that may be used in time of some future emergency.
18. Each band should assign some member the rank of Security Officer and should set up a system of fines or other penalties for failure to comply with security precautions.
19. Observe the 'need to know' rule. Each member should be given only that information which is needed by him in the performance of his duty or which he will need in cooperating with other members of the band. No member should feel 'left out' because he is denied such information. Instead every member should willingly avoid information which he does not need.
20. Be careful that you are not followed in going to and from meeting places or in making contact with other members of the organization.
21. Keep all records and correspondence carefully hidden and in a manner that they can be easily destroyed. Records should be kept in code whenever possible.
22. Important as secrecy may be, it is not the only essential factor in a successful underground movement. Morale and efficiency are equally important. Elaborate security measures always reduce efficiency to a greater or lesser degree. Unnecessary security can create an atmosphere of suspicion that is devastating to the esprit de corps of any organization. Find a proper balance between security and efficiency.

Monthly Report Form:

I.D. No. if assigned by new coordinator.....

Name if not assigned I.D. No.....

Address if different than one used to mail this letter.....

.....

If you desire to join send name address and phone No.

1. Summarize your activities on behalf of the Minutemen during the last month:

.....

2. What are the needs and requirements of your group; that Headquarters might be able to assist you with.....

3. Do you have any remarks or suggestions.....

4. Have you any New prospective members for the Minutemen, if so give their names and addresses.....

.....

5. How can Headquarters assist you in becoming more active in the operations of the Minutemen? And to help you advance our objectives?.....

.....

6. Are your monthly dues current?.....

We have available at this time all of the training phases for \$2.00 per copy or \$8.00 for the set of five. Also all manuals and bulletins from Norborne since 1961. We are printing every day so if there is some special item you want let us know and we will do our very best.

.....Enclosed \$.....for.....

.....

Monthly dues..... Legal defense.....

Postage..... Other.....

TOTAL.....

SAC, SAN DIEGO (157-2177)(P)

3/15/71

SA JOHN O. TRETHERWEY, JR.

THOMAS LEE FORREST, aka
SM - MM

On 3/5/71, ~~_____~~ * advised SA STEVEN L. CHRISTENSEN that subject definitely associates with known members of the Minutemen organization in the San Diego area, is ultra-right in his politics, is involved in purchasing and selling of automatic weapons and possibly in the manufacture of them and that he would be hostile to any attempts by FBI Agents to interview him.

2 - 157-2177
1 - 100-12461
① - 170-286-A
2-174
JOT/gar
(4) QAM

new

170-2861-87

SEARCHED _____	INDEXED _____
SERIALIZED _____	FILED _____
MAR 16 1971	
FBI - SAN DIEGO	

Date prepared

3/26/71

Date received

2/23/71

Received from (name or symbol number)

[Redacted] *

Received by

SA Steven L. Christensen

Method of delivery (check appropriate blocks)

in person by telephone by mail orally recording device written by Informant

If orally furnished and reduced to writing by Agent:

Date

Dictated 3/16/71 to Linda Elejido

Transcribed 3/23/71

Authenticated by Informant _____

Date of Report

2/23/71

Date(s) of activity

week ending
2/23/71

Brief description of activity or material

Contact with Isaac Cantrell & Dave Knorr, Yuma, Arizona Gun Show

File where original is located if not attached

* INDIVIDUALS DESIGNATED BY AN ASTERISK (*) ONLY ATTENDED A MEETING AND DID NOT ACTIVELY PARTICIPATE. VIOLENCE OR REVOLUTIONARY ACTIVITIES WERE NOT DISCUSSED.

Information recorded on a card index by _____ on date _____

Remarks:

157-2224 (Isaac Cantrell)
170-286A-82
157-1798 (MM)
100-65400 (Jerry Geyer)

Index: Dave Knorr to 157-1798; Bob Kyle & Larry Stork to Geyer's file.

170-286-A-82
Block Stamp

SEARCHED	INDEXED
SERIALIZED	FILED
MAR 23 1971	
FBI - SAN DIEGO	

[Handwritten signature]

ON FEBRUARY 23, 1971
BY JEROME

ISAAC CANTRELL was contacted last night. He said he would make available, 5 or 6 .45 caliber machine gun barrels. He said these can be picked up Friday, the 26th of February, from another person, not CANTRELL. He said he will also make contact with a person in Nevada who owns a mine and who can furnish large quantities of dynamite.

CANTRELL still appears to be paranoid and claims he is followed about three days a week by someone driving a red Datsun or Toyota automobile.

CANTRELL did considerable talking about police officer BUD BENNETT. This is apparently the officer responsible for CANTRELL's recent arrest and CANTRELL hates him intensely. He said he wants to acquire all available information regarding BENNETT such as his home address and telephone number and the license number and description of the automobile which he drives.

CANTRELL also claimed he has a case of dynamite buried in the vicinity of Indio, California.

A right wing individual named DAVE KNORR was contacted last week. He claimed to know of the existence of a group of Minutemen (MM) at Alpine, California. He said these persons are always interested in purchasing weapons.

While at the gun show at Yuma, Arizona, last weekend, he met an individual named BOB KYLE who is supposed to be JERRY GEYER's best friend. KYLE had several magazines for the Russian AK 47 automatic rifle which sold very fast. KYLE's wife is named GINGER. KYLE is about 5'7" tall, dark complexion, dark hair, 30-35 years old. He may work at some local military base as he seems to have excellent access to parts to military weapons. It was mentioned that he does some dealing with Marines at Camp Pendleton.

Another of GEYER's friends who was at the gun show was LARRY STORCH (PH) who had a fairly large number of weapons to seel. He was about 30 years old, 6'2" tall, or taller, dark brown hair. (Possibly identical with LARRY STORTS, a former San Diego police officer who left the department to go to law school.)

Date prepared

3/29/71

Date received

3/9/71

Received from (name or symbol number)

[Redacted] *

Received by

SA Steven L. Christman

Method of delivery (check appropriate blocks)

in person by telephone by mail orally recording device written by Informant

If orally furnished and reduced to writing by Agent:

Date

Dictated

3/23/71 to Eteguino

Transcribed

3/26/71

Authenticated by Informant

Date of Report

3/9/71

Date(s) of activity

3/1/71

Brief description of activity or material

Info re Troy Houghton

File where original is located if not attached

* INDIVIDUALS DESIGNATED BY AN ASTERISK (*) ONLY ATTENDED A MEETING AND DID NOT ACTIVELY PARTICIPATE. VIOLENCE OR REVOLUTIONARY ACTIVITIES WERE NOT DISCUSSED.

Information recorded on a card index by _____ on date _____

Remarks:

100-14015
170-286A-83
100-14297
100-14819

Block Stamp

170-286A-83

SEARCHED INDEXED
SERIALIZED FILED
MAR 11 1971
FBI - SAN DIEGO
Christman

MARCH 9, 1971

BY JEROME

About 3/1/71, BARRY GODFREY was in contact with SAM DAVIS. Apparently, DAVIS and GODFREY were discussing the disappearance of TROY HOUGHTON. DAVIS mentioned that at some unspecified time, he had talked to a man who he did not identify. He claimed to have been present when HOUGHTON was killed. DAVIS said this man told him HOUGHTON was poisoned with cyanide somewhere in Louisiana and then his body was left in the swamps there.

Jerome

Date prepared

3/29/71

Date received

3/11/71

Received from (name or symbol number)

[Redacted] *

Received by

SA Steven L. Christensen

Method of delivery (check appropriate blocks)

in person by telephone by mail orally recording device written by Informant

If orally furnished and reduced to writing by Agent:

Date

Dictated

3/23/71 to E. Legins

Transcribed

3/26/71

Authenticated
by Informant

Date of Report

3/11/71

Date(s) of activity

3/10/71

Brief description of activity or material

info re SD PAC

File where original is located if not attached

* INDIVIDUALS DESIGNATED BY AN ASTERISK (*) ONLY ATTENDED A MEETING AND DID NOT ACTIVELY PARTICIPATE. VIOLENCE OR REVOLUTIONARY ACTIVITIES WERE NOT DISCUSSED.

Information recorded on a card index by _____ on date _____

Remarks:

100-129913 (San Diego Peace Action

190-286A-84 Coalition)

100-14293

100-~~129~~14087 (John Somerville

Block Stamp

170-286A-84
SEARCHED _____ INDEXED _____
SERIALIZED _____ FILED _____
APR 1 1971
FBI - SAN DIEGO
[Signature]

MARCH 11, 1971

BY JEROME

I was in contact with BILL CLAY yesterday, who furnished me with copies of some literature of the San Diego Peace Action Coalition. All leaflets are signed by JOHN SOMERVILLE and had the address 1426 Merritt Drive, El Cajon, California, telephone 447-1641. The literature indicates this San Diego group is affiliated with the National PAC and furthermore, invites recipients of the literature to a meeting on 3/7/71.

Jerome

Date prepared

3/29/71

Date received

3/10/71

Received from (name or symbol number)

~~XXXXXXXXXX~~ *

Received by

SA Steven L. Christensen

Method of delivery (check appropriate blocks)

in person by telephone by mail orally recording device written by Informant

If orally furnished and reduced to writing by Agent:

Date

Dictated

3/23/71 to Eteguino

Transcribed

3/26/71

Authenticated by Informant

Date of Report

3/10/71

Date(s) of activity

3/9/71

Brief description of activity or material

Info re. Peter Ruppinger & MM activities

File where original is located if not attached

* INDIVIDUALS DESIGNATED BY AN ASTERISK (*) ONLY ATTENDED A MEETING AND DID NOT ACTIVELY PARTICIPATE. VIOLENCE OR REVOLUTIONARY ACTIVITIES WERE NOT DISCUSSED.

Information recorded on a card index by _____ on date _____

Remarks:

157-1798
170-286A-85
100-14301 (Peter Ruppinger)
100-15337
157-594

Block Stamp

170-286A-85

SEARCHED _____ INDEXED _____

SERIALIZED _____ FILED _____

FBI - SAN DIEGO

[Signature]

MARCH 10, 1971
BY JEROME

PETER RUPLINGER was contacted yesterday and the photograph of MORRIS STARSKEY was shown to him. He said that for sometime now, he has been trying to find out who STARSKEY is and has even been following him from time to time looking for a chance to pick up his briefcase. RUPLINGER said he has also been following LEON NOWERS around the campus, the last time being the day before yesterday. He said on that day, NOWERS went to the Student Placement Office, where he reviewed the files maintained there on FBI and CIA employment. He said he believes possibly NOWERS was looking for names of students who are applying or have applied for work with these Government agencies.

There is a rumor going around that the Minutemen may try to stage some opposition to any San Diego area anti-war activities to be held on 4/15/71.

To the best of my knowledge, I have not heard of any MM or other right wingers being involved in a Confederate skirmish unit at Ramona, California, as reported in yesterday's Evening Tribune.

Jerome

Date prepared
3/29/71

Date received: 3/9/71
Received from (name or symbol number): ~~XXXXXXXXXX~~ *
Received by: SA Steven L. Christensen

Method of delivery (check appropriate blocks)
 in person by telephone by mail orally recording device written by Informant

If orally furnished and reduced to writing by Agent:
Date Dictated: 3/23/71 to Elegino
Transcribed: 3/26/71
Authenticated by Informant: _____

Date of Report: 3/9/71

Date(s) of activity: 3/7-9/71

Brief description of activity or material
MM activities at Gunsnoke Ranch

File where original is located if not attached

* INDIVIDUALS DESIGNATED BY AN ASTERISK (*) ONLY ATTENDED A MEETING AND DID NOT ACTIVELY PARTICIPATE. VIOLENCE OR REVOLUTIONARY ACTIVITIES WERE NOT DISCUSSED.
 Information recorded on a card index by _____ on date _____

Remarks:
~~157-1798 (M.M.)~~
170-286A-86
100-14297
100-15356
100-14610 (Stan Mc Dade)
100-14819
100-14015
100-14016
100-15666 (Roger Willis)

Block Stamp

170-286A-86
SEARCHED _____
SERIALIZED _____ FILED _____
APR 1 1971
FBI - SAN DIEGO
[Signature]

MARCH 9, 1971

BY JEROME

It has been learned that last Friday, SAM DAVIS was doing a lot of talking about shooting people. He said even if he eventually leave this area, he will make some trips back for the purpose of eliminating some people. He then said that at one time, he almost killed a girlfriend of GEORGE HOOVER. She was then living at the ranch with HOOVER but returned to Germany, where she was born, when they broke up.

DAVIS said he was in favor of killing her because she apparently knew too much and wanted to set up a shooting accident at the ranch to get rid of her. GEORGE HOOVER vetoed the idea however, and they let her return to Germany.

Last Sunday, at the Gunsmoke Ranch, it was observed that a complex range system has been set up there. There are many people who come there frequently to practice and sometimes there are as many as 50 persons present. Last Sunday, STAN MC DADE and his son, BARRY GODFREY, ROGER WILLIS, a FRANK LNU and 4 other people were there practicing. It was observed that several of these people are quite proficient on the range and in the handling the use of their weapons. He observed that STAN MC DADE and BARRY GODFREY, while digging through a pile of junk on the range, came across a piece of a .50 caliber machine gun; which is interesting.

It is known that BETTIE HOUGHTON has always wanted to be interviewed by FBI about the disappearance of her husband, TROY and now might be even more willing to discuss matters relating to her husband and to DEPUGH.

Jerome

Date prepared

4/13/71

Date received

4/7/71

Received from (name or symbol number)

[Redacted] X

Received by

SA Steven L. Christensen

Method of delivery (check appropriate blocks)

in person by telephone by mail orally recording device written by Informant

If orally furnished and reduced to writing by Agent:

Date

Dictated _____ to _____

Transcribed _____

Authenticated by Informant _____

Date of Report

4/7/71

Date(s) of activity

4/7/71

Brief description of activity or material

4/24/71 Demonst. San Francisco; San McDade; Peter Ruppinger

File where original is located if not attached

* INDIVIDUALS DESIGNATED BY AN ASTERISK (*) ONLY ATTENDED A MEETING AND DID NOT ACTIVELY PARTICIPATE. VIOLENCE OR REVOLUTIONARY ACTIVITIES WERE NOT DISCUSSED.

Information recorded on a card index by _____ on date _____

Remarks:

100-286A-87
100-14356 (Ruppinger)
100-15575 (Anti-war Demonstration, San Francisco, 4/24/71)
100-14610 (McDade)
100-14939 (John Bush)
100-14819 (Godfrey)

Index: Howard Cleveland
to 100-14610

Block Stamp

100-286A-87

SEARCHED INDEXED
SERIALIZED FILED
APR 11 1971
FBI - SAN DIEGO

[Handwritten signature]

April 7, 1971

Report of Jerome

PETER RUPLINGER was contacted this morning. He claims that there will be nine buses going from San Diego State to the anti-war demonstration at San Fransisco on the twentyfourth of this month. He said he will find out later from where and when they are leaving and how many people will be on the buses. He knows about the \$900 given the demonstrators by the school and will try to find out if they get any more money from other sources.

STAN MC DADE was also contacted this morning and was accompanied by HOWARD CLEVELAND. It was learned that MC DADE and HOWARD GODFREY were at Camp Pendleton yesterday looking at the scrap parts pile of the Ordnance Disposal unit there. They believe there may be several complete weapons of various kinds which could be made from the scrap parts. For this reason they are considering submitting a bid on the some forty tons of scrap which is to be sold. It was learned that JOHN BUSH is also going to enter a bid.

MC DADE and CLEVELAND indicated they are going to the dexeret in the morning to spend several days doing some shooting and exploring.

Jerome

Date prepared

5/3/71

Date received

4/27/71

Received from (name or symbol number)

[Redacted] *

Received by

SA Steven L. Christensen

Method of delivery (check appropriate blocks)

in person by telephone by mail orally recording device written by Informant

If orally furnished and reduced to writing by Agent: Date

Dictated _____ to _____

Transcribed _____

Authenticated by Informant _____

Date of Report

4/27/71

Date(s) of activity

4/26/71

Brief description of activity or material

Sam Davis; Bettie Haughton
Don Carey

File where original is located if not attached

* INDIVIDUALS DESIGNATED BY AN ASTERISK (*) ONLY ATTENDED A MEETING AND DID NOT ACTIVELY PARTICIPATE. VIOLENCE OR REVOLUTIONARY ACTIVITIES WERE NOT DISCUSSED.

Information recorded on a card index by _____ on date _____

Remarks:

100-286A-88
100-14297 (Davis)
100-1614 (Haughton)
100-1813 (Haughton)
157-1798 (NM)

Index: Don Carey to
100-14297

Block Stamp

100-286A-88

SEARCHED	INDEXED
SERIALIZED	FILED
MAY 5 1971	
FBI - SAN DIEGO	

Christensen

April 27, 1971

BY JEROME

SAM DAVIS was contacted yesterday. He had been to BETTIE HAUGHTON's place and had received from her the complete list of former Minuteman members which was in her possession. She is also going to give him all the field manuals she has, several cases of them, and her medical supplies. SAM said he also believes he knows the identity of the man who helped TROY HAUGHTON bury his caches of weapons and supplies in the Sierras. Included in this stuff is supposed to be an entire packaged Army field hospital which was allegedly stolen from the military. SAM said he will try to get acquainted with this person.

A person named DON CAREY has come to my attention. He is also known as DON VON BECK and HENNING VON BECK. He claims to be the son of a World War II German general named VON BECK. He works as a blaster for Canyon Rock and Gravel Company and has told people he has a cabin near Campo and three rented garages in which he has stored a lot of weapons, parts, ammunition and explosives. He is believed to be a lot of talk. I will try to find out more about him.

Jerome

Date prepared

5/25/71

Date received

5/17/71

Received from (name or symbol number)

[Redacted] X

Received by

SA Steven L. Christensen

Method of delivery (check appropriate blocks)

in person by telephone by mail orally recording device written by Informant

If orally furnished and reduced to writing by Agent:

Date

Dictated _____ to _____

Transcribed _____

Authenticated by Informant _____

Date of Report

5/17/71

Date(s) of activity

5/17/71

Brief description of activity or material

Info re Ron Zarco & AR Sales

File where original is located if not attached

* INDIVIDUALS DESIGNATED BY AN ASTERISK (*) ONLY ATTENDED A MEETING AND DID NOT ACTIVELY PARTICIPATE. VIOLENCE OR REVOLUTIONARY ACTIVITIES WERE NOT DISCUSSED.

Information recorded on a card index by _____ on date _____

Remarks:

170-286A-89
100-14297 (Davis)
100-2177 (Tom Forrest)
100-14296 (Conde)

Index: Ron Zarco,
CAR Sales to 100-14297

Block Stamp

170-286A-89

SEARCHED	INDEXED
SERIALIZED	FILED
MAY 26 1971	
FBI - SAN DIEGO	

Christensen

May 17, 1971

Report of Jerome

SAM DAVIS was overheard to say that an individual named RON ZARICK is one of the biggest weapons suppliers in the San Diego area and can usually get anything that SAM asks him for. This is supposed to be one of SAM's contacts who is trying to get him a grease gun or a Sten gun.

It was also learned that a woman named LILLIAN (LNU) is coming down from Los Angeles next week. She is the wife of the owner of A R Sales and will be in town to take an order from SAM for some M-16 conversion kits. A R Sales allegedly has a huge inventory of weapons parts and is also supposed to be dealing in automatic weapons.

SAM claimed to have purchased \$500 worth of M-2 conversion parts from TOM FORREST last month. He indicated that most or all of these parts would go to the Cuban refugees through LOU CONDE.

Jerome

Date prepared

5/25/71

Date received

5/21/71

Received from (name or symbol number)

~~XXXXXXXXXX~~ *

Received by

SA Steven L. Christensen

Method of delivery (check appropriate blocks)

in person by telephone by mail orally recording device written by Informant

If orally furnished and reduced to writing by Agent:

Date

Dictated _____ to _____

Transcribed _____

Authenticated by Informant _____

Date of Report

5/21/71

Date(s) of activity

5/20/71 +
5/21/71

Brief description of activity or material

~~Gene Geyer; Joseph Lynn Davis~~
~~Lillian Kernes~~

File where original is located if not attached

* INDIVIDUALS DESIGNATED BY AN ASTERISK (*) ONLY ATTENDED A MEETING AND DID NOT ACTIVELY PARTICIPATE. VIOLENCE OR REVOLUTIONARY ACTIVITIES WERE NOT DISCUSSED.

Information recorded on a card index by _____ on date _____

Remarks:

170-286A - 90
100-15400 (Geyer)
~~100~~¹⁵⁷ - 2177 (Forrest)
100-14297 (Davis)
100-14819 (Godfrey)
100-14296 (Conde)

Index: ~~Gene Geyer &~~
Lillian Kernes to
100-14297; Bob Kile to
100-15400 (Geyer)

Block Stamp

170-286A-90

SEARCHED	INDEXED
SERIALIZED	FILED
MAY 26 1971	
FBI - SAN DIEGO	

Christensen, J. Hill

May 21, 1971

Report of Jerome

It has been learned that HOWARD GODFREY was at Gerry Geyer's house yesterday. GEYER gave GODFREY six booby trap simulators. He hinted he has a contact who may have stolen 3000 Army manuals on booby trap devices being used in Viet Nam. GEYER seems to get most of his material from BOB KILE and TOM FORREST.

I am to contact SAM DAVIS tomorrow morning and then go with him to BETTIE HAUGHTON's house to pick up the field manuals and other supplies she has. We will sort through the manuals for those we want and then sell the rest. any money made from these sales will be given back to BETTIE.

An individual named GENE BROWN is supposed to come down from the Los Angeles area tomorrow afternoon. We will meet him at the Zoo entrance at about 2:00 pm. This is for the purpose of making contact with some of the Right Wing sympathizers at Los Angeles.

The woman from A R Sales is LILLIAN KARNES. A R Sales is making an alloy receiver for the .45 auto pistol, and there was a big write up on the company and the receiver in the last issue of "Guns and Ammo" magazine. It is rumored around that her husband was picked up at one time with 500 machineguns in his possession, so the business is now in the name of his wife and allegedly being run by her.

LILLIAN KARNES is supposed to be a Puerto Rican and SAM thinks she and her company are supplying weapons and other items to the Cuban refugees. This has made SAM interested in contacting the Alpha 66 group, and he wants to go talk to LOU CONDE to see if this can be arranged.

Jerome

Date prepared

6/15/71

Date received

6/8/71

Received from (name or symbol number)

~~XXXXXXXXXX~~ *

Received by

SA Steven L. Christensen

Method of delivery (check appropriate blocks)

in person

by telephone

by mail

orally

recording device

written by Informant

If orally furnished and reduced to writing by Agent:

Date

Date of Report

6/8/71

Dictated _____ to _____

Date(s) of activity

6/7 + 8/71

Transcribed _____

Authenticated by Informant _____

Brief description of activity or material

"Doc Roberts"; Barry Godfrey;
Al Delefield

File where original is located if not attached

* INDIVIDUALS DESIGNATED BY AN ASTERISK (*) ONLY ATTENDED A MEETING AND DID NOT ACTIVELY PARTICIPATE. VIOLENCE OR REVOLUTIONARY ACTIVITIES WERE NOT DISCUSSED.

Information recorded on a card index by _____ on date _____

Remarks:

170-286A-91
100-15400 (Geyer)
100-14819 (Godfrey)
100-15061 (YWLH)

Index: Doc Roberts to
100-15400 (Geyer); Al
Delefield to 100-15061

Block Stamp

170-256A-91

SEARCHED INDEXED

SERIALIZED FILED

JUN 16 1971

FBI - SAN DIEGO

Christensen - ML

Report by Jerome

June 8, 1971

A person I have heard about before named "Doc Roberts" was in town yesterday morning with 15 assorted military machine guns to deliver to an unknown person. JERRY GEYER was the middle man on this end of the transaction and the deal took place in Lakeside, California. It is not known where or to whom the machine guns went.

It was also learned that BARRY GODFREY will deliver some M-2 parts to JERRY GEYER's house this evening which will be turned over to ROBERTS.

It has also been learned that AL DELLEFIELD of Los Angeles, California, will be in town on June 11, 1971. He is described as the press secretary for the Southern California Young Workers Liberation League. He is to deliver a speech presented by the Peoples World and sponsored by a group known as Freedom of the Press Committee located in El Cajon, California, with telephone number 442-5843. DELLEFIELD will speak about the Peoples World and ways to increase the circulation of that paper.

A speech is scheduled for Room 11 of the Conference Hall, Balboa Park, at 8:00 p.m. on June 11, 1971.

Jerome

Date prepared
6/23/71

Date received
6/17/71

Received from (name or symbol number)
* [redacted]

Received by
SA Steven L. Christensen

Method of delivery (check appropriate blocks)
 in person by telephone by mail orally recording device written by Informant

If orally furnished and reduced to writing by Agent:
Date _____
Dictated _____ to _____
Transcribed _____
Authenticated by Informant _____

Date of Report
6/17/71

Date(s) of activity
6/17/71

Brief description of activity or material
Ron Zarec; Josephine Davis;
Bessie Haughton

File where original is located if not attached

* INDIVIDUALS DESIGNATED BY AN ASTERISK (*) ONLY ATTENDED A MEETING AND DID NOT ACTIVELY PARTICIPATE. VIOLENCE OR REVOLUTIONARY ACTIVITIES WERE NOT DISCUSSED.

Information recorded on a card index by _____ on date _____

Remarks:
170-286A-92
100-14297 (Davis)
100-14819 (Goodfry)
157-1614 (Haughton)
157-28 (ANP)
105-3220 (States Rights Party)
157-1813 (Haughton)

Index: Ron Zarec to 100-14297; Joseph Cotton to ~~100~~ 157-1813 (Haughton).

Very copy made for 157-2921

Block Stamp

170-286A-92

SEARCHED	INDEXED
SERIALIZED	FILED
JUN 25 1971	
FBI - SAN DIEGO	

Christensen [initials]

June 17, 1971

BY JEROME

... ZAREC today. He is employed in the garden shop at the Sears store in El Cajon. His home phone number is 441-1111. He offered me an M-2 kit which I turned down. He indicated he is a big dealer in ammunition. SAM DAVIS has said he is also a good contact for all types of weapons and related supplies. ZAREC doesn't know I am acquainted with SAM.

SAM appears to have considerable money. He talked about the upcoming gun show in Pasadena and warned that the A.S. may attempt to make some arrests there. I am planning to go to the show as there are supposed to be some meetings of people associated with the NSWPP and the SRP afterwards.

SAM DAVIS mentioned the other day he had been talking to BETTIE HAUGHTON and JOSEPH COTTON who runs a Right Wing program in the Los Angeles area. BETTIE still believes ROBERT DE PUGH to have been responsible for the death of TROY HAUGHTON. She indicated she has some witnesses and allegedly has filled out an affidavit recently with everything but the witnesses' names. She wants to file charges DE PUGH and have him tried for TROY's death.

Jerome

SAC (174-428)(P)

7/6/71

SA EARL M. PETERSEN

JERRY LYNN DAVIS, aka;
EUGENE BROWN;
BOMBING MATTER

At 8:25 a.m. 7/5/71, the writer contacted ~~_____~~ at which time he stated that he had just gotten off work at 8:00 a.m. after working an eight hour shift. He said he had read in the paper the article concerning the bombing of an IRS office at San Jose, California but that he has heard nothing from DAVIS or BROWN.

During the forenoon of 7/5/71, STEVE LOGAN of ATFD, IRS, telephoned and asked the writer to contact source and have him contact DAVIS to see what DAVIS had to say and to see if he was in San Diego. After clearing this with Supervisor #4, source was contacted and he said he would contact DAVIS on some pretext.

Informant drove to DAVIS's house and enroute he was stopped by the Highway Patrol who checked out his identification. They gave him no ticket. When source parked about a block from DAVIS's house, a San Diego County Sheriff car drove up and checked his license plate by stopping behind his car. This was observed by DAVIS and his mother who was ~~visiting~~ visiting him. When source entered the DAVIS residence, the mother stated that she had told her son that she figured source was a friend of his since he brought "the fuzz" with him.

DAVIS and source had a long conversation about whether BROWN had participated in the bombing of the IRS building in San Jose. They observed that he had said he only had black powder and fire-bombs but felt that plenty of ammonium nitrate was easily available and that he could possibly have used this explosive. Neither of them had any first hand information concerning the bombing.

DAVIS suggested that they lay low for a while because of the bombing in San Jose.

D - 170-286A
EMP:emp
(3)

93

170-286A-57

SEARCHED	INDEXED
SERIALIZED	FILED
FBI - SAN DIEGO	

Date prepared

7/16/71

Date received

7/14/71

Received from (name or symbol number)

[Redacted] *

Received by

SA Steven L. Christensen

Method of delivery (check appropriate blocks)

in person by telephone by mail orally recording device written by Informant

If orally furnished and reduced to writing by Agent:

Date

Date of Report

7/14/71

Dictated _____ to _____

Date(s) of activity

Transcribed _____

Authenticated by Informant _____

7/14/71

Brief description of activity or material

Sam Davis; ANP; Stan McDade
Troy Haughton; Bettie Haughton

File where original is located if not attached

* INDIVIDUALS DESIGNATED BY AN ASTERISK (*) ONLY ATTENDED A MEETING AND DID NOT ACTIVELY PARTICIPATE. VIOLENCE OR REVOLUTIONARY ACTIVITIES WERE NOT DISCUSSED.

Information recorded on a card index by _____ on date _____

Remarks:

100-286A-94
100-14297 (Davis)
157-28 (ANP)
100-14610 (McDade)
157
100-1614 (Haughton)
157
100-1813 "

Block Stamp

100-286A-94

SEARCHED	INDEXED
SERIALIZED	FILED
JUL 10 1971	
FBI - SAN DIEGO	

Christensen

July 14, 1971

REPORT BY JEROME

I was in telephone contact with SAM DAVIS today. He appears to be very hooked on joining the American Nazi Party. STAN MC DADE is the one who is pushing the hardest on joining the Nazis. I understand that DAVIS and MC DADE will get together to look for office space for the Nazi Party headquarters in the San Diego area.

DAVIS also said he is going out tomorrow to find some office equipment, for this purpose. He said there is a possibility that the local group may get some financial help from the Nazi Party at Los Angeles.

DAVIS also advised he knows of the whereabouts of one of TROY HAUGHTON's old hideouts. He said this hideout is still in tact and usable and that he, DAVIS, might have to make use of it himself if things get to hot for him in San Diego. He mentioned that HAUGHTON stayed in this hideout for a long period of time on one occasion when the police department was looking for him. It was thought that he was not in town because they had been unable to find him. DAVIS said, to the best of his knowledge, the location of the hideout is now known only to him and BETTIE HAUGHTON.

n

Jerome

Date prepared

7/16/71

Date received

7/1/71

Received from (name or symbol number)

~~XXXXXXXXXX~~ X

Received by

SA Steven L. Christensen

Method of delivery (check appropriate blocks)

in person by telephone by mail orally recording device written by Informant

If orally furnished and reduced to writing by Agent:

Date

Date of Report

7/1/71

Dictated _____ to _____

Transcribed _____

Authenticated by Informant _____

Date(s) of activity

7/1/71

Brief description of activity or material

Tom Forrest; Gary Geyer;
theft of (alleged) Navy knives

File where original is located if not attached

* INDIVIDUALS DESIGNATED BY AN ASTERISK (*) ONLY ATTENDED A MEETING AND DID NOT ACTIVELY PARTICIPATE. VIOLENCE OR REVOLUTIONARY ACTIVITIES WERE NOT DISCUSSED.

Information recorded on a card index by _____ on date _____

Remarks:

170-286A-96
~~157~~ -2177 (Forrest)
100-15400 (Geyer)

Index: Bob Kyle to
100-15400 (Geyer)

170-286A-96
Block Stamp

SEARCHED INDEXED
SERIALIZED FILED
JUL 19 1971
FBI - SAN DIEGO
Christensen Jll

July 1, 1971

REPORT BY JEROME

I learned today of the recent theft of a large number, more than 2,000, of U.S. Navy Mark I sheath knives. It was indicated to me that TOM FORREST has 300 of these knives, Ski's Swap Shop (owned by FNU SKIBOWSKI) near 40th and University, bought a large number of them and has a few personally and openly on display. BOB KYLE reportedly sold several 100 to the Patch and Ball Gun Shop. An individual known as "Little Joe" is said to have several 100 of these knives and JERRY GEYER says that he has a lot of several 100 of the knives staked out which he is attempting to acquire.

Jerome

UNITED STATES GOVERNMENT

Memorandum

TO : SAC, SAN DIEGO (174-4280)

DATE: 8/3/71

FROM : SA STEVEN L. CHRISTENSEN

SUBJECT: JERRY LYNN DAVIS, aka;
EUGENE BROWN
BOMBING MATTER

*

On the evening of 8/2/71 ~~XXXXXX~~ was contacted at which time he advised that Subject DAVIS had told him that day he was temporarily unemployed and was in a desperate need of money. DAVIS indicated that he would be willing to sell most of the explosive materials given by him to the informant at the following prices:

Box of 50 electric blasting caps	\$20.00
Box of 100 fuse blasting caps (two)	10.00 (both)
1 pound xxx block of TNT	6.00
1/2 pound block of TNT	3.00
plastic bag of TNT prills	5.00
Hand grenade fuses - 13 @ \$4.50	81.00
M2 trip levers - 35 @ \$2.50	87.50
Rifle grenade - empty	4.00
Rifle grenade - charged, yellow smoke	5.00
Ammunition cans - 4 @ 1.00	4.00
XXXXXX Total	\$216.50 225.50

Informant advised that DAVIS would want returned to him the camouflauge uniform, the blasting cap crimpers, the three military electric blasting caps for detonating composition "C" explosives, the fifteen loose, time delay, electric blasting caps, and the remainder of the fix rifle parts.

On 8/3/71 Special Investigator STEVE LOGAN, ATFD, was contacted regarding this matter and whether ATFD would be willing to allow the return of the foregoing items to DAVIS through the informant, with the blasting caps being deactivated or inert caps substituted. LOGAN then telephonically contacted his supervisor, RICHARD JOHNSON, ATFD, Santa Ana. It was the concurrent opinion of both JOHNSON and LOGAN that the items which ~~xxxx~~ DAVIS will want returned to him, with the exception of the blasting caps, do not represent any violation of law under the jurisdiction of ATFD, and, under normal circumstances would be returned to the owner anyway. With regard to the blasting caps, in view of remote possibility of prosecution



2 - SD 174-4280
1 - SD 170-236A
1 - SD 100-14297
SLC/slc
(4)

- 174-4280-AT-98

SEARCHED	INDEXED
SERIALIZED	FILED
AUG 11 1971	
FBI - SAN DIEGO	

Buy U.S. Savings Bonds Regularly on the Payroll Savings Plan

in this matter, they interposed no objection to returning to DAVIS deactivated or inert blasting caps, feeling that the record of their possession by the Government and disposition would serve as well for evidence purposes as having the caps themselves.

On 8/3/71 SGT. WILLIAM BIRCH, 70th Ordnance Detachment (EOD), Fort. Rosecrans, San Diego, California, advised that there is no effective way that the blasting caps in question could be deactivated without extreme danger to the attempting this action and without it being obvious that the caps had been tampered with. SGT. BIRCH advised that the manufacturers of all such blasting caps make inert caps ~~which~~ for training and identification purposes which are indistinguishable from the live ones. He said that in his opinion the best course of action would be to obtain such inert caps to substitute for the ones now in the possession of the Government. He said that the best source of information as to where to obtain these substitutes would be the Institute of Makers of Explosives, 420 Lexington Ave., New York City, 10017.

Memorandum

TO : SAC, SAN DIEGO (100-14297)

FROM : SA STEVEN L. CHRISTENSEN

SUBJECT: JERRY LYNN DAVIS, aka
EX - MM

DATE: 9/20/71

On this date ~~_____~~ advised he was at a meeting on the evening of 9/19/71 which was also attended by Subject, HOWARD CLARK and one ED ANDREWS.

Among other things discussed source learned that Subject apparently obtained from CLARK the residence address of SA ARNOLD W. O'BRIEN, which information DAVIS has long sought. Source is not aware how CLARK may have obtained this address or whether it is in fact SA O'BRIEN's correct address. He said the information was apparently over one year old. He said he believes he will be able to obtain this address from DAVIS within the next day or two.

- 1 - SD 100-14297 (JERRY LYNN DAVIS)
 - ① - SD 170-286 A
 - 1 - SD 157- (HOWARD CLARK)
 - 1 - SD 157- (ED ANDREWS)
- SIC/s lc
(4)

170-256A-99

SEARCHED _____	INDEXED _____
SERIALIZED _____	FILED _____
SEP 21 1971	
FBI - SAN DIEGO	

a



Buy U.S. Savings Bonds Regularly on the Payroll Savings Plan

Memorandum

TO : SAC, SAN DIEGO (107-2224)

DATE: 10/6/71

FROM : SA STEVEN L. CHRISTENSEN

SUBJECT: ISAAC, WILLIAM CANTRELL
E - NM

On 10/5/71, ~~██████████~~ advised he has been attempting to contact the Subject, unsuccessfully, and has come to the conclusion CANTRELL has left the San Diego area.

On 10/6/71, **CONF. SOURCE** advised records contain a forwarding address for Subject dated 5/27/71, showing a change from Alpine, California, to P.O. Box 1104, Fabens, Texas 79338.

Foregoing submitted for information only.

① - SD 170-286 A
1 - SD 157-2224
SLC/slc
(2)

170-286-A-100

SEARCHED _____	INDEXED _____
SERIALIZED _____	FILED _____
OCT 7 1971	
FBI - SAN DIEGO	
Gle	



Buy U.S. Savings Bonds Regularly on the Payroll Savings Plan

Date prepared

3/29/71

Date received

3/26/71

Received from (name or symbol number)

~~XXXXXXXXXX~~ *

Received by

SA STEVEN L. CHRISTENSEN

Method of delivery (check appropriate blocks)-

in person, by telephone, by mail, orally, recording device, written by Informant

If orally furnished and reduced to writing by Agent:

Date

Date of Report

3/26/71

Dictated

to SA

Date(s) of activity

3/26 and 27/71

Transcribed

Authenticated
by Informant

Brief description of activity or material

Info regarding JERRY LYNN DAVIS,
MC DADE and PAUL RUPLINGER.

File where original is located if not attached

* INDIVIDUALS DESIGNATED BY AN ASTERISK (*) ONLY ATTENDED A MEETING AND DID NOT ACTIVELY PARTICIPATE. VIOLENCE OR REVOLUTIONARY ACTIVITIES WERE NOT DISCUSSED.

Information recorded on a card index by _____ on date _____

Remarks:

100-14297 DAVIS
100-14610 MC DADE
100-14301 RUPLINGER
~~170-286A-267~~
100-14819 GODFREY

Block Stamp

170-286A-101

SEARCHED INDEXED
SERIALIZED FILED

MAR 31 1971
FBI - SAN DIEGO

[Handwritten signature]

JEROME
3/26/71

I was in contact with PAUL RUPLINGER. He continued to be interested in creating disturbances and offered to take Right Wing leaders for a drive along Interstate 8 to show them where they could use dynamite on underpasses and overpasses to create the most disruption. It has been learned that SAM DAVIS and BARRY GODFREY may drive up to Los Angeles tomorrow to contact the people who own and run AR Sales, for the purpose of finding out about the availability of military manuals and various weapons.

DAVIS, GODFREY and MC DADE continue to talk about setting up a new organization to handle Right Wing activities in the San Diego area. Arrangements have been made for them to meet soon at a drive-in restaurant to talk about ways and means of setting up such an organization with a legal defense fund, a newspaper or bulletin and harassment activities.

Date prepared

4/9/71

Date received

3/31/71

Received from (name or symbol number)

~~XXXXXXXXXX~~ *

Received by

SA STEVEN L. CHRISTENSEN

Method of delivery (check appropriate blocks)

in person by telephone by mail orally recording device written by Informant

If orally furnished and reduced to writing by Agent:

Date

Date of Report

3/31/71

Dictated _____ to _____

Date(s) of activity

3/31 - 4/4/71

Transcribed _____

Authenticated by Informant _____

Brief description of activity or material

~~American Legion March in downtown San Diego on 4/4/71.~~

File where original is located if not attached

* INDIVIDUALS DESIGNATED BY AN ASTERISK (*) ONLY ATTENDED A MEETING AND DID NOT ACTIVELY PARTICIPATE. VIOLENCE OR REVOLUTIONARY ACTIVITIES WERE NOT DISCUSSED.

Information recorded on a card index by _____ on date _____

Remarks:

170-286a - 102
157-1798 (Minutemen)

170-286A-102
Block Stamp

SEARCHED INDEXED
SERIALIZED FILED
APR 11 1971
FBI - SAN DIEGO
A. [Signature]

JEROME
3/31/71

I have heard there will be an American Legion march in downtown San Diego on Sunday, 4/4/71, to protest the court-martial of Lt. WILLIAM CALLEY. This march is being sponsored partially by Radio Station KSON and all Right Wing groups in the San Diego area are being urged to join in. A call has been put out for 50,000 participants and to the best of my knowledge, no parade permit has been obtained from the San Diego Police Department. I was in contact with one of the women who is pushing the march. She has telephone 276-6648. According to her, the march will start about 12 NOON from the Navy Recreation Field at Harbor Drive and Market Street, will proceed up Harbor Drive to 8th Avenue, from there to Broadway and then back to Harbor Drive and the Recreation Field for a rally. The woman told me they have received 3700 phone calls since last night. She said the march seems to be getting much support from the military, adding that two Generals and three Colonels have indicated they will participate in the march in full uniform.

Date prepared

4/9/71

Date received

4/2/71

Received from (name or symbol number)

~~XXXXXXXXXX~~

X

Received by

SA STEVEN L. CHRISTENSEN

Method of delivery (check appropriate blocks)

in person by telephone by mail orally recording device written by Informant

If orally furnished and reduced to writing by Agent:

Date

Dictated _____ to _____

Transcribed _____

Authenticated by Informant _____

Date of Report

4/2/71

Date(s) of activity

4/1 and 2/71

Brief description of activity or material

INFO re JERRY LYNN DAVIS

File where original is located if not attached

* INDIVIDUALS DESIGNATED BY AN ASTERISK (*) ONLY ATTENDED A MEETING AND DID NOT ACTIVELY PARTICIPATE. VIOLENCE OR REVOLUTIONARY ACTIVITIES WERE NOT DISCUSSED.

Information recorded on a card index by _____ on date _____

Remarks:

170-286A-103
100-14297 DAVIS

Block Stamp 170-286A-103

SEARCHED INDEXED
SERIALIZED FILED
APR 11 1971
FBI - SAN DIEGO
A. Christensen

JEROME
4/2/71

I was in contact with SAM DAVIS last night. He claimed to have received a call earlier in the evening from the Klu Klux Klan in Mississippi. The only explanation he would give is that something he was involved in there broke open and he is afraid he may be arrested soon. If so, he says he knows who is responsible and he will take care of them later. However, he is very shaken up and has been talking about going underground until the problem blows over. In the past he has claimed to have been involved in robberies, burglaries, and illegal weapons deals which may account for what he is afraid of now.

However, if he is still in town on Sunday, he will join in the march protesting the trial of Lt. CALLEY and may try to start a confrontation if people show up to demonstrate against the march.

Date prepared

4/9/71

Date received

4/4/71

Received from (name or symbol number)

~~XXXXXXXXXX~~ X

Received by

SA STEVEN L. CHRISTENSEN

Method of delivery (check appropriate blocks)

in person by telephone by mail orally recording device written by Informant

If orally furnished and reduced to writing by Agent:

Date

Dictated _____ to _____

Transcribed _____

Authenticated by Informant _____

Date of Report

4/4/71

Date(s) of activity

4/3 - 4/71

Brief description of activity or material

INFO re travel of JERRY LYNN DAVIS and GEORGE HOOVER to Arizona

File where original is located if not attached

* INDIVIDUALS DESIGNATED BY AN ASTERISK (*) ONLY ATTENDED A MEETING AND DID NOT ACTIVELY PARTICIPATE. VIOLENCE OR REVOLUTIONARY ACTIVITIES WERE NOT DISCUSSED.

Information recorded on a card index by _____ on date _____

Remarks:

170-286A-104

100-14297 DAVIS

100-15356 HOOVER

100-14293 CLAY

100-14819 GODFREY

2-100 - EV MOORE (O & A)

INDEX

EV MOORE to ~~DAVIS~~ file

Block Stamp

170-286A-104

SEARCHED INDEXED SERIALIZED FILED

FBI - SAN DIEGO

[Handwritten signature]

JEROME
4/4/71

It has been learned that SAM DAVIS and GEORGE HOOVER left yesterday morning to go to a construction project in Arizona. They intend to make use of this trip to make contacts with people they know or have heard of in Las Vegas, Phoenix, and El Paso. They are supposed to call back after making these contacts. DAVIS left his brief-case with BARRY GODFREY and because of what happened in Mississippi, was talking about the possibility of going underground but sneaking back to the San Diego area later on.

The person to be contacted in Phoenix is EV MOORE.

DAVIS claims that of the Right Wing groups that are still intact, the one at Las Vegas is the best run and is already functioning. He said it is supposed to have Mafia connections and is also the best source of many kinds of supplies.

DAVIS wants the San Diego area Post Office Box which was rented in BILL CLAY's name dropped and a new Post Office Box rented so that CLAY cannot get at the mail.

Date prepared
5/11/71

Date received
5/5/71

Received from (name or symbol number)

~~XXXXXXXXXX~~ *

Received by
SA CHRISTENSEN (STEVEN)

Method of delivery (check appropriate blocks)

in person by telephone by mail orally recording device written by Informant

If orally furnished and reduced to writing by Agent:
Date

Dictated _____ to _____

Transcribed _____

Authenticated by Informant _____

Date of Report

5/5/71

Date(s) of activity

5/4 and 5/71

Brief description of activity or material

Info re firearms activities
of JERRY LYNN DAVIS and BARRY GODEREY

File where original is located if not attached

* INDIVIDUALS DESIGNATED BY AN ASTERISK (*) ONLY ATTENDED A MEETING AND DID NOT ACTIVELY PARTICIPATE. VIOLENCE OR REVOLUTIONARY ACTIVITIES WERE NOT DISCUSSED.

Information recorded on a card index by _____ on date _____

Remarks:

~~170-286A-105~~

100-14297 DAVIS ~~XXXXXXXXXX~~

157-~~157-1798~~ BETTIE HAUGHTON

157-1798 Minuteman

100-14819 GODFREY

157-2077 Tom Forrest

2-157-

DON CAREY, aka (O & A)

Index

DON CAREY, aka

Don Von Beck, Henning Von Beck
to 157-1798

152-1798-57

170-286A-105

Block Stamp

SEARCHED INDEXED
SERIALIZED FILED
MAY - 11 1971
FBI - SAN DIEGO
A. [Signature]

a

JEROME
5/5/71

I was in contact with SAM DAVIS yesterday. He had come from BETTIE HAUGHTON's place. She gave him the entire former Minuteman membership list which she had in her possession, along with cases of field manuals and other literature as well as a large quantity of medical supplies and items. DAVIS seems to think he knows the name of the person who helped TROY HAUGHTON bury many of his supplies in the Sierras, included among which is supposed to be a whole packaged Army field hospital which they stole somewhere.

I have come across an individual named DON CAREY. He is also known as DON VON BECK and to some people as HENNING VON BECK. He claims to be the son of the German World War II General named VON BECK. He is a blaster for Canyon Rock and Gravel Company. He impresses me as being a big talker but claims to have a cabin at Campo and three rented garages full of weapons, including machine guns, weapons parts, ammunition and explosives.

SAM claims that he can order me a Sten gun for \$100. He also says that TOM FORREST is one of his two San Diego suppliers but that he makes most of his purchases in Washington and Oregon. DAVIS claims he has been dealing with FORREST for about 6 - 8 months and claims to have recently purchased \$500 worth of M-2 carbine parts from FORREST for the purpose of making short M-2 "enforcers".

According to what DAVIS has been saying, FORREST appears to have contacts with military personnel at Camp Pendleton through which he makes weekly raids on armories and the supplies there. DAVIS has apparently asked BARRY GODFREY to go with him to Camp Pendleton to show him the location of the scrap parts pile of the ordnance disposal unit on that base.

DAVIS continues to talk about and work on the Right Wing organization he wants to establish. His idea is to contact people he knows in Phoenix, Seattle, Portland, and Las Vegas and have individuals in all those cities give out a press release announcing the formation of the new organization.

In addition, leaflets and stickers will be put out the same day and post office boxes for the organization retred in all these cities on the same day so as to completely disguise the location of the national headquarters which will be in San Diego, with DAVIS and GODFREY running the thing. He wants to structure the organization along military lines with military ranks and training for the purpose of creating a Right wing organization to overthrow the government in this country.

Date prepared

11/10/71

Date received

11/4/71

Received from (name or symbol number)

[Redacted] *

Received by

SA Steven L. Christensen

Method of delivery (check appropriate blocks)

in person by telephone by mail orally recording device written by Informant

If orally furnished and reduced to writing by Agent:

Date

Dictated

to

Transcribed

Authenticated by Informant

Date of Report

11/4/71

Date(s) of activity

11/3-4/71

Brief description of activity or material

Info re Hoover, McWade, Nazi Party, Rev. Gale, Marge McNichols Patriotic Party, Barry Goldwater

File where original is located if not attached

170-286A

* INDIVIDUALS DESIGNATED BY AN ASTERISK (*) ONLY ATTENDED A MEETING AND DID NOT ACTIVELY PARTICIPATE. VIOLENCE OR REVOLUTIONARY ACTIVITIES WERE NOT DISCUSSED.

Information recorded on a card index by _____ on date _____

Remarks:

- 170-286A-106
- 9-823
- 100-14519 (Goldwater)
- 157-1818 (McNichols)
- 100-14610 (McWade)
- 100-13832 (Patriotic Party)
- 157-1798 (MM)
- 157-28 (Nazi Party)
- 100-15356 (Hoover)
- 100-15355 (Busch)
- 157-201 (Smith)
- 2 - Los Angeles

Index: Reverend Gale & Theo McNichols to 157-1818

Block Stamp

170-286A-106

SEARCHED	INDEXED
SERIALIZED	FILED
NOV 1 1971	
FBI - SAN DIEGO	

an

November 4, 1971
By "Jerome"

I was told by Barry Godfrey that he and George Hoover went by Peace House #1 at 2143 Market Street last night. Godfrey said the place appeared to be unoccupied at the time and when he and Hoover looked inside, saw it to be full of books and other literature, and all kinds of materials. They also claimed to have driven by the house at 3121 Beech which Godfrey said is a big house at the corner of the street.

Godfrey also stated that Hoover, Stan McDade, and Jerry Lee Busch, went to a meeting of Gerald Lee Smith's Nazi Party group last night. Hoover was wearing the uniform of the new group he is trying to organize. This organization will be a branch of the Missionary Church of Jesus Christ headed by Reverend Gale at Los Angeles, California.

While at the meeting, because of some internal trouble, and because they liked Hoover's uniform better than the Nazi uniform, most of Smith's group decided to leave the Nazi Party organization and join Hoover's new group.

I don't know anything about a Reverend Pike or Peak, but the Reverend Gale may be the same one who is head of Missionary Church of Jesus Christ at Los Angeles. Gale comes to town about once a month to fulfill a speaking assignment here. He has Nazi and anti-Semitic tendencies although he is not known to me as being a member of the Nazi Party.

Also, I have heard nothing about threatening telephone calls being made by anyone locally to obtain the release of the Patriotic Party members in Michigan; however, Margaret L. McNichols, who lives at 2113 Whispering Pines Drive in Julian, is closely acquainted with the individuals in Michigan named Freed. At one time, she told me she and Freed both belonged to some German club and showed me a photograph of her and Freed together at a meeting in Santa Ana, California.

Page two

McNichols claimed to have been the Secretary-Treasurer of the Western Region of the Patriotic Party, covering 11 western states and is also a close associate of Robert Bolivar DePugh. McNichols is also acquainted with Reverend Gale, who has been connected with the Patriotic Party.

McNichols and her husband, Leo, own and operate a grocery store on Main Street in Julian named the Mountain Market. Leo McNichols is, or was employed by the FAA at Julian.

I believe that Margaret McNichols is the type of person who might make threatening telephone calls in behalf of members of the Patriotic Party, but do not know if she has actually done this.

Date prepared

1/6/72

Date received

6/14/71

Received from (name or symbol number)

[Redacted]

Received by

SA Stewart. Christensen

Method of delivery (check appropriate blocks)

in person by telephone by mail orally recording device written by Informant

If orally furnished and reduced to writing by Agent:
Date

Dictated _____ to _____

Transcribed _____

Authenticated by Informant _____

Date of Report

6/14/71

Date(s) of activity

6/13/71

Brief description of activity or material

Info re conversation of Barry Godfrey & Sam Davis

File where original is located if not attached

* INDIVIDUALS DESIGNATED BY AN ASTERISK (*) ONLY ATTENDED A MEETING AND DID NOT ACTIVELY PARTICIPATE. VIOLENCE OR REVOLUTIONARY ACTIVITIES WERE NOT DISCUSSED.

Information recorded on card index by _____ on date _____

Remarks:

- 100-14819 (Godfrey)
- 100-14297 (Davis)
- 157-1614 (Haughton)
- 100-15356 (Hoover)
- 157-1813 (Bettie Haughton)
- 157-1928 (MM)

Pertinent info previously disseminated.

Index: Paul Hunt, Dennis Mower, Mary Tollerston to 157-1614

170-286A - 107

86

Block Stamp

170-286A-107

SEARCHED _____ INDEXED _____

SERIALIZED _____ FILED _____

JAN 1972

FBI - DENVER

Christensen MP

June 14, 1971
BY JEROME

I was talking with BARRY GODFREY last night. He said he had just spent sometime with SAM DAVIS the same evening and that DAVIS admitted to being a total anarchist. He said that DAVIS thinks that the U.S. government is as much an enemy of the people, meaning right wing conservatives as the left wing movement is. He said DAVIS is still interested in attempting to formulate a new organization to take the place of the old Minuteman Group. BARRY said DAVIS wants to set up 2 right wing groups, one, an open group which would conduct intelligence type operations and the other a covert group which would conduct sabotage and harassment and obtain such things as explosives and machine guns.

GODFREY said the conversation with DAVIS got around to TROY HOUGHTON and DAVIS said he has known for two years what actually happened to HOUGHTON and added that BETTY HOUGHTON has also had the same information. According to DAVIS, a meeting was held at which BETTY HOUGHTON, DAVIS, PAUL HUNT, DENNIS MOWER, GEORGE HOOVER, and one other unidentified individual were present. The meeting was held for the purpose of hearing an oral report from MARY TOLLERTON as to what had happened to TROY HOUGHTON, that he had been held prisoner by ROBERT DE PUGH in the basement of DE PUGH's house with the help of WALTER PEYSON.

June 14, 1971
By JEROME

HOUGHTON was then poisoned to death and his body disposed of somewhere in the State of Missouri. After the meeting, BETTY HOUGHTON was in favor of making all this information public and requesting a grand jury investigation of DE PUGH and PEYSON for her husband's death. However, the other people present at the meeting talked her out of this close of action.

GODFREY then said DAVIS told him that he knows of a total of five people who were killed by DE PUGH, including TROY HOUGHTON. He said two of these were killed after HOUGHTON's death to keep his murder quiet. DAVIS said that MARY TOLLERTON was being hidden in the Los Angeles area for quite a while by DENNIS MOWER, PAUL HUNT and others as there was thought DE PUGH was looking for her to kill her. Some how, she got away from MOWER and HUNT for a period of about six months but then they got her back again. Allegedly, BETTY HOUGHTON told MOWER to keep track of MARY TOLLERTON at all cost even if he had to marry her.

According to DAVIS, it is his belief HOUGHTON was killed by DE PUGH as DE PUGH thought HOUGHTON had already contacted the FBI or was in the process of arranging such a contact for the purpose of informing on DE PUGH's activities.

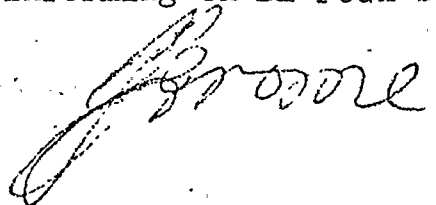

Date received 6/15/71 Received from (name or symbol number) [redacted] *

Received by SA Steven I. Christensen

Method of delivery (check appropriate blocks)

in person by telephone by mail orally recording device written by Informant

If orally furnished and typed to writing by Agent:

Dictated _____ to _____

Transcribed _____

Authenticated by Informant _____

Date of Report

6/15/71

Date(s) of activity

6/15/71

Brief description of activity or material

Info on Ron Zarick; NSWPP
NSRP

File where original is located if not attached

* INDIVIDUALS DESIGNATED BY AN ASTERISK (*) ONLY ATTENDED A MEETING AND DID NOT ACTIVELY PARTICIPATE. VIOLENCE OR REVOLUTIONARY ACTIVITIES WERE NOT DISCUSSED.

Information recorded on a card index by _____ on date _____

Remarks:

52-547
~~157-28~~ (Ron Zarick) (new info)
157-28 (NSWPP)
100-14217 (Sam Davis)
105-3220 (NSRP)
157-1728 (MM)
100-14879 (Godfrey) Erf

Relevant info previously disseminated

170-256A-100

Block Stamp

170-286-A-108
SEARCHED _____ INDEXED _____
SERIALIZED _____ FILED _____
JAN 6
FBI - ONLY DIST.
Christensen

June 15, 1971
By JEROME

This morning, I met an individual named RON ZARICK who was attempting to sell military ammunitions of several calibers. I will try to find out more about him later.

I also learned that there were 12 members of the NSWPP at the anti-war demonstration at NEL Center yesterday. SAM DAVIS may also have been there as he appeared to know a lot about it. DAVIS has had a project going to get himself fired from his job and may already have been successful. If so, He will go on unemployment and then on welfare in order to be able to devote full time to his right wing activities. He has approached me about going to a meeting at Los Angeles in the next few days with representatives of the Minutemen organization, the States Right Party, and the NSWPP for the purpose of discussing the possibility of an alliance of these groups. He mentioned that the national leader of the States Rights Party may be at the meeting. I will try to find out more about this also.

I also learned that DAVIS wants to set up a course of instruction in the use of explosives which would start off with a group composed of BARRY GODFREY and two men selected by him and SAM DAVIS and two men selected by him .

Jerome

Date prepared

1/5/72

Date received

6/21/71

Received from (name or symbol number)

[Redacted] *

Received by

Steven L. Christensen

Method of delivery (check appropriate blocks)

in person by telephone by mail orally recording device written by Informant

If orally furnished and reduced to writing by Agent:

Date

Dictated _____ to _____

Transcribed _____

Authenticated by Informant _____

Date of Report

6/21/71

Date(s) of activity

6/21/71

Brief description of activity or material

Conf info re right wing activists.

File where original is located if not attached

* INDIVIDUALS DESIGNATED BY AN ASTERISK (*) ONLY ATTENDED A MEETING AND DID NOT ACTIVELY PARTICIPATE. VIOLENCE OR REVOLUTIONARY ACTIVITIES WERE NOT DISCUSSED.

Information recorded on a card index by _____ on date _____

Remarks:

- 100-14297 (Davis)
- 157-2832 (Don Carey)
- ~~157~~-1820 (Frank Yacopco)
- 100-14292 (Brinker)
- 100-14610 (McDade)
- 100-14939 (John Bush)

Particant info previous disseminated.

Index:

Ron Hunicutt, Rick Lindsay, Bob Robinsc Alex Rapidprint to 100-14297

170-286A-109

of

Block Stamp

170-286A-109

SEARCHED _____ INDEXED _____

SERIALIZED _____ FILED _____

JAN 10 1972

FBI - CHICAGO

[Signature]

June 21, 1971
BY JEROME

The person I have recently come into contact with is RON HUNICUTT who lives on 37th Street in San Diego. He allegedly has some .45 caliber automatic pistol receivers with the serial numbers ground off. BOB ROBINSON, a telephone company employee, had one which he looked at not too long ago. Apparently, HUNICUTT is a big dealer in guns, ~~and is known to SAM DAVIS by a different name.~~

Another person who is ^{an} ~~a close~~ associate of SAM DAVIS is DON CAREY, ⁱⁿ ~~another~~ individual by the name of RICK LINDSAY ^{a SD PD officer} ~~who has been acting as a go-between for~~ ROBINSON and CAREY, ^{is a friend of both} who is known to Davis by another name.

I also understand that CAREY took an examination for employment with the U. S. Border Patrol not too long ago. He has been hinting of knowledge of the whereabouts of M-60 machine gun which he described as a good riot gun. He is also trying to become "friends" with DAN DWYER, who operates a gun smithing shop on Washington in San Diego and who is well known to SAM DAVIS.

ALEX RAPIDPRINT has been doing the plates for some of the new forms and other printed material for the local right wing group.

FRANK YACOPEC continues to do well after having been in the hospital for removal of kidney stones.

June 21, 1971
By JEROME

I was at STAN MC DADE's place on Saturday and JOSEPH BRINKER showed up there.

I was also in touch with JOHN BUSH who offered me an action for an anti-tank rifle for \$45.00.

Jerome

Date prepared

1/6/92

Date received

6/23/91

Received from (name or symbol number)

~~XXXXXXXXXX~~ *

Received by

Steven L. Christensen

Method of delivery (check appropriate blocks)

in person by telephone by mail orally recording device written by Informant

If orally furnished and reduced to writing by Agent:

Date

Date of Report

6/23/91

Dictated _____ to _____

Date(s) of activity

6/22/91

Transcribed _____

Authenticated by Informant _____

Brief description of activity or material

Conversation with Paul

Ruplinger & General Kenney

File where original is located if not attached

* INDIVIDUALS DESIGNATED BY AN ASTERISK (*) ONLY ATTENDED A MEETING AND DID NOT ACTIVELY PARTICIPATE. VIOLENCE OR REVOLUTIONARY ACTIVITIES WERE NOT DISCUSSED.

Information recorded on a card index by _____ on date _____

Remarks:

- 100-14301 (Ruplinger)
- 100-14297 (Davis)
- ~~157-5212~~ (Ron Zarick)
- 700-14819 (Godfrey)
- 157-28 (NSW RP)
- 100-14303 (Walton)
- ~~100-5348~~ (Bertram Comperet)

Pertinent info previously disseminated

Index: General Kenney to 100-14301.

Scott Winchester to 157-28 - also Joe Tomasi

170-286A-110

of

Block Stamp

170-286A-110

SEARCHED INDEXED SERIALIZED FILED

JAN 1992

FBI - ORIN DIST.

BY [Signature]

JUNE 23, 1971
BY JEROME

I was in conversation with PAUL RUPLINGER and General LEMLEY yesterday. LEMLEY said he has some M-16 rifles and has been giving weapons to all of his neighbors for self defense.

LEMLEY is extremely militant and I understand that he, RUPLINGER, and perhaps SAM DAVIS refused to fill out the U.S. Census Forms which they received and expected to be arrested shortly and placed in jail.

LEMLEY says that lots of weapons and other items of military equipment are coming down to the U.S. out of Canada. LEMLEY was extremely upset at the arrests made by ATFD and local law enforcement officers at the Pasadena Gun Show on 6/19/71. He said he was going to contact the headquarters of the John Birch Society (which he is deeply involved in) at San Marino, and have that organization check into the arrests. PAUL RUPLINGER was also very upset about the situation.

It should be noted that in talking with RON ZARICK before the gun show took place, he warned me to be cautious at the gun show as he had received word that the ATFD and State officials were planning to make arrests at the show.

It has come to my attention that both SAM DAVIS and BARRY GODFREY are fairly well acquainted with SCOTT WINCHESTER, leader of the Nazi Party Group, Bishop Faction, at Los Angeles, California.

-2-

JUNE 23, 1971
BY JEROME

WINCHESTER appears to be a near kook. He was one of the more active participants in the anti-war demonstration sponsored by MDM at Oceanside, California, in May, 1970. He was running around like a roving idiot and screaming, "fascist pigs" at the police.

SAM DAVIS says he heard that the NSWPP at San Diego might favor a split from the NSWPP at Los Angeles which is headed by (FNU) TOMASCO and join up with WINCHESTER's group. If this happens, it will take place through the efforts of VIC WALTON or BERTRAM COMPARET.

Joe Tomasi
Jerome

Date prepared

1/6/72

Date received

9/12/71

Received from (name or symbol number)

~~XXXXXXXXXX~~ *

Received by

Steven L. Christensen

Method of delivery (check appropriate blocks)

in person by telephone by mail orally recording device written by Informant

If orally furnished and reduced to writing by Agent:

Date

Dictated _____ to _____

Transcribed _____

Authenticated by Informant _____

Date of Report

9/12/71

Date(s) of activity

9/12/71

Brief description of activity or material

~~Info San Davis, NSWPP,
Hoyer, McDade, Peto, Godfrey
etc.~~

File where original is located if not attached

* INDIVIDUALS DESIGNATED BY AN ASTERISK (*) ONLY ATTENDED A MEETING AND DID NOT ACTIVELY PARTICIPATE. VIOLENCE OR REVOLUTIONARY ACTIVITIES WERE NOT DISCUSSED.

information recorded on a card index by _____ on date _____

Remarks:

- 100-14297 (Davis)
- 157-28 (NSWPP)
- 100-14819 (Godfrey)
- 157-1816 (James Peto)
- ~~100-14175 (Roger Willis)~~
- 100-14610 (McDade)
- 157-201 (Smith)

Pertinent info previously disseminated. Index Scott Winchester American Socialist Workers Party to 157-28 Roger Willis to 100-14297

170-286A-111

of

Block Stamp

170-286A-111

SEARCHED	INDEXED
SERIALIZED	FILED

JAN 6 1972
FBI - SAN DIEGO
Christensen
JL

July 1971

REPORT BY JEROME

I was in contact with SAM DAVIS this morning. He finally got his wish and was fired from his job. He did not go to work as he was supposed to this morning and while I was at his house his boss called saying that he had some important jobs for DAVIS to take care of. He said if DAVIS could not be more reliable, he, the boss, would have to find someone else to do the job. DAVIS then told him to go ahead and find someone else whereupon his boss hung up. DAVIS said he has another job to go to in the middle of next week for one ROGER (LNU). This job will last approximately one month following which DAVIS will be laid off and then can claim unemployment and welfare while devoting full time to his activities. He believes he can draw unemployment for a period of approximately six months. He talked again about the explosives and other materials which he has and some of which he has given to me.

He said he has come across opportunities to buy other such materials at fairly low cost and, therefore, wants to sell some of the stuff he now has to get money to buy these other materials and also to help the Nazi Party out financially.

DAVIS stated that it is his intention to join the American Nazi Party and showed me his membership application form. It is my understanding that the local Nazi group which has, in the past, been part of the National Socialist White Peoples Party (NSWPP), will switch allegiance in the near future to the Bishop Faction of the American Nazi Party now headed up by SCOTT WINCHESTER at Los Angeles, California.

If and when this takes place, the name they apparently will use for the new group is American Socialist Workers Party.

DAVIS is all excited about buying uniforms and other things to get ready to go on "storm trooper" duty. He said he is going to try and get all of his associates, including GEORGE HOOVER, STAN MC DADE, JAMES POTO, BARRY GODFREY, ROGER WILLIS and "AL" (LNU) to join also.

According to DAVIS, the Nazi Party group which he has been hearing so much about lately is only a segment of the total Nazi group in the San Diego area. GERALD L. K. SMITH, the leader of this active group, is apparently only what is called a section leader. There are apparently several sections of the Nazi Party group in San Diego and overall leader for the whole group.

DAVIS said that he and three other people, one of whom will probably be STAN MC DADE and the other two members of the NSWPP in San Diego, will go to Los Angeles soon to see SCOTT WINCHESTER and make arrangements for merging with his group.

DAVIS says that the Nazi Party group is good on organizing but poor on weapons acquisition and intelligence work. He said he expects to be of considerable help to the Nazis in these two areas.

He said he has been in contact with BARRY GODFREY and had asked him to do some work on compiling a list of liberal members of the Jewish community in San Diego as a starting point for harassment and other tactics by the Nazis. He said that the Nazis have been using DON SISCO's Militants Formulary as a handbook for training in explosives etc. He said SISCO himself is reported to be a section leader for either the Bishop Faction of the Nazi Party or the NSWPP.

DAVIS' telephone number is listed in the directory under B. L. GIBSON at 2393 Washington, Lemon Grove, California. The telephone number is 465-9572.

DAVIS indicated that he has been offered 100 grenade bodies with the necessary parts to make live weapons from them for a sum of \$25.00.

This morning I observed all the parts of a disassembled .30 caliber Browning air-cooled machine gun in the back room of the Bullseye Gun Shop.

Jerome

Date prepared

1/6/72

Date received

7/25/71

Received from (name or symbol number)

~~XXXXXXXXXX~~ *

Received by

Steven L. Christensen

Method of delivery (check appropriate blocks)

in person by telephone by mail orally recording device written by Informant

If orally furnished and reduced to writing by Agent:

Date

Date of Report

7/20/71

Dictated _____ to _____

Date(s) of activity

7/18/71 - 7/24/71

Transcribed _____

Authenticated by Informant _____

Brief description of activity or material

Info re Sam Davis, Barry Godfrey, NSWPP

File where original is located if not attached

* INDIVIDUALS DESIGNATED BY AN ASTERISK (*) ONLY ATTENDED A MEETING AND DID NOT ACTIVELY PARTICIPATE. VIOLENCE OR REVOLUTIONARY ACTIVITIES WERE NOT DISCUSSED.

Information recorded on a card index by _____ on date _____

Remarks:

100-14297 (Davis) Pertinent info previously disseminated.
100-14819 (Godfrey)
157-201 (Smith)
157-28 (NSWPP)
100-14610 (McNade) &
170-286A-12

Block Stamp

170-286A-12
SEARCHED INDEXED
SERIALIZED FILED
JAN 6 1972
FBI - OMAHA
Christensen

July 20, 1971

By JEROME

SAM DAVIS says he has an operation in mind for this weekend. He said he wants BARRY GODFREY to provide six men; DAVIS will provide another six and the NSWPP will furnish 12 men to conduct a raid on a faculty office at UCSD, where a Viet Cong Flag is supposed to be hanging. The purpose of the raid will be to seize the flag, take it out on the campus, and burn it in front of as large a crowd as they can get.

DAVIS said he is also trying to get ahold of a white phosphorous grenade for another project he has in mind for the weekend, but would not even hint as to what he is thinking of using it for.

I went to a recent meeting of the NSWPP with STAN MC DADE. GERALD L. SMITH was speaking. One of the other people at the meeting had a medal for what is referred to by the American Nazi Party as the "Virginia Campaign", which occurred in 1958. These medals were awarded by GEORGE LINCOLN ROCKWELL, which would indicate that the person I saw at the meeting must be a longtime Nazi Party member. This individual

Page Two

said he is going to Los Angeles soon with MC DADE and SMITH to meet with Nazi Party Officials there.

MC DADE has been gathering a big list of Jews for the NSWPP and was asking about the location of a good uniform shop as he wants to buy a Khaki Uniform to wear to meetings.

Jerome

Date prepared

1/6/72

Date received

9/21/71

Received from (name or symbol number)

[Redacted] *

Received by

Steven L. Christensen

Method of delivery (check appropriate blocks)

in person by telephone by mail orally recording device written by Informant

If orally furnished and reduced to writing by Agent:
Date

Dictated _____ to _____

Transcribed _____

Authenticated by Informant _____

Date of Report

9/21/71

Date(s) of activity

9/20-21/71

Brief description of activity or material

Info re Peter Ruppinger & Tom Forrest

File where original is located if not attached

* INDIVIDUALS DESIGNATED BY AN ASTERISK (*) ONLY ATTENDED A MEETING AND DID NOT ACTIVELY PARTICIPATE. VIOLENCE OR REVOLUTIONARY ACTIVITIES WERE NOT DISCUSSED.

Information recorded on a card index by _____ on date _____

Remarks:

- 100-14356 (Ruppinger)
- 100-14819 (Goetz)
- 157-2177 (Tom Forrest)
- 157-5212 (Ron Zarick)

170-286A-113

Relevant info previously disseminated

Index Dick Gould, Larry Brown, Bill Gwilt, Chuck Pierce to 157-

Block Stamp

170-286A-113

SEARCHED INDEXED
SERIALIZED FILED

JAN 6 1972
FBI - DENVER

[Handwritten signature]

July 21, 1971

By JEROME

It appears that PETER RUPLINGER has a friend in a small arms arsenal or depot on one of the local Navy Bases. He has been offering the sale of four M-2 conversion kits, and says he thinks he will be able to furnish all the small arms including grenades and possibly a light .30 caliber machine gun that anyone would want. He was asking BARY GODFREY if GODFREY could obtain a tear gas grenade which RUPLINGER wants for the purpose of throwing into the "Bedroom", a local night club offering nude entertainment.

I saw TOM FORREST yesterday and while there observed a .45 caliber grease gun with two full magazines.

Some time ago I met a person named DICK GOULD. Yesterday I saw him again and he offered me a sawed off shotgun and another shotgun which had been made into a pistol. He wanted \$50 for both of the weapons but did not have them with him for me to look at. I will try to find out more about GOULD.

Page Two

Another person I have heard a lot about is one LARRY BROWN. He apparently used to live close to me and some friends were telling me at one time about what a nut and raving maniac he is. He apparently has moved to Poway. Yesterday while I was at Bulls Eye Gun Shop BILL GUIETTE was telling me about some work he was doing on a nine millimeter German Schmeitzer. Today I was in Bulls Eyes again and met this LARRY BROWN and talked to him for about one hour. He was telling me all about his nine millimeter German Schmeitzer and hinted that he may have some other automatic weapons. Very likely the Schmeitzer GUIETTE was working on belonged to BROWN. I will also try to find out more about BROWN.

CHUCK PIERCE, ~~the San Diego John Birch Society~~ leader, lives at 8527 Goldenridge Road, Lakeside, California, and has telephone number 449-4176. He and BILL GUIETTE have been talking about joining the U.S. Army, Special Forces, Reserve Unit in San Diego, purely for the purpose of seeing what items of equipment they can steal.

This reserve unit is already supposed to be very heavy with right wing nuts and there are rumors that a lot of weapons and other equipment are already coming out

Page Three

of that outfit. I was also in contact with RON ZARICK again. He offered to sell me 2000 rounds of .30-06 ammunition at 5¢ a round and told me that he also has 30,000 rounds of .30 carbine ammunition.

Jerome

Date prepared

1/6/72

Date received

7/13/71

Received from (name or symbol number)

~~XXXXXXXXXX~~ *

Received by

Steven L. Christensen

Method of delivery (check appropriate blocks)

in person

by telephone

by mail

orally

recording device

written by Informant

If orally furnished and reduced to writing by Agent:

Date

Date of Report

7/13/71

Dictated _____ to _____

Date(s) of activity

7/13/71

Transcribed _____

Authenticated
by Informant _____

Brief description of activity or material

Info re Rick Burns

File where original is located if not attached

* INDIVIDUALS DESIGNATED BY AN ASTERISK (*) ONLY ATTENDED A MEETING AND DID NOT ACTIVELY PARTICIPATE. VIOLENCE OR REVOLUTIONARY ACTIVITIES WERE NOT DISCUSSED.

Information recorded on a card index by _____ on date _____

Remarks:

100-

(Rick Burns) (new info file)

170-286A-114

g

Block Stamp

170-286A 114

SEARCHED _____ INDEXED _____

SERIALIZED _____ FILED _____

JAN 10 1972

FBI - SAN DIEGO

Christensen

July 13, 1971
By JEROME

It has come to my attention that there is an individual who may be of interest who works for the San Diego Fire Department and is assigned to Station 13 in La Jolla. His name is RICK BURNS and he has been overheard to make statements which are highly pro-Russian and pro-Communist China. He saves up his money and vacation time and travels to Russia each summer.

BURNS apparently lives in the La Jolla area as he walks to work every morning. He is about 27, 5'11", 180 husky build. He has light brown hair, a ruddy complexion, wears reading glasses, is married and has a collie dog. He allegedly served in the U.S. Marine Corps and has been with the Fire Department for about four and one half years.

Jerome

Date prepared

1/6/72

Date received

7/13/71

Received from (name or symbol number)

[Redacted] *

Received by

Steven H. Christensen

Method of delivery (check appropriate blocks)

in person by telephone by mail orally recording device written by Informant

If orally furnished and reduced to writing by Agent:

Date

Dictated _____ to _____

Transcribed _____

Authenticated by Informant _____

Date of Report

7/13/71

Date(s) of activity

Brief description of activity or material

Sub re Peter Ruppinger

File where original is located if not attached

* INDIVIDUALS DESIGNATED BY AN ASTERISK (*) ONLY ATTENDED A MEETING AND DID NOT ACTIVELY PARTICIPATE. VIOLENCE OR REVOLUTIONARY ACTIVITIES WERE NOT DISCUSSED.

Information recorded on a card index by _____ on date _____

Remarks:

100 - 14356 (Ruppinger)
170 - 286A - 115

Partinent info previously disseminated.
Index Phillip Saluato to 100 - 14356

af

Block Stamp

170 - 286A - 115
SEARCHED INDEXED
SERIALIZED FILED
JAN 16 1972
FBI - PHOENIX
[Signature]

July 13, 1971

REPORT BY JEROME

Yesterday I was in contact with PETER RUPLINGER. He is still self employed as a wholesale diamond dealer. He said one of his customers is allegedly an Italian who has connections with the local tuna fishing association and with the Mafia. He said he had acquired from this person a rifle with a silencer which he told RUPLINGER was a Mafia assassination weapon. He obtained this rifle from RUPLINGER yesterday evening for \$20.00. The rifle is a British Enfield bolt action rifle and a .303 caliber. It has been heavily modified with an extension having been added to the butt stock and the parts of the receiver assembly missing exposing the internal working mechanism. The rear sight is also missing.

The breech ends of the receiver and barrel on this rifle are usually threaded with a square cut thread. However on this rifle, these parts both have a regular toothed machine thread which was obviously done to allow the rifle to be disassembled into two pieces.

The forestock of the rifle is also missing and a device, reported to be a silencer, has been added to the breech end of the barrel. This device is approximately 2" in diameter and 5" long and cylindrical in shape. There is a $\frac{1}{2}$ " diameter aluminum tube extending from the forward bottom part of this device along the barrel almost to the muzzle. Attached to the muzzle is the regular issue British flash suppressor for use on the Enfield .303 caliber carbine. Most of the metal parts of the rifle have been coated with black lacquer.

When assembled, the rifle does not headspace properly which is apparently due to the threads being worn or a necessary shim missing.

I recontacted RUPLINGER this morning and learned that the individual he obtained the rifle from is one PHILLIP SALUATO, 6766 Rose Field Drive, San Diego, California. RUPLINGER said SALUATO allegedly has other weapons including Thompson submachine guns and M-2 carbines which he will sell. RUPLINGER also said that the silenced

rifle which he sold me was supposedly delivered to SALUATO by the Mafia for destruction or permanent disposal. He said SALUATO, who is apparently eager to make a fast buck, apparently decided to sell the weapon rather than destroy it.

From my knowledge of RUPLINGER, I suspect it is very likely he enlarged considerably on this story.

Jerome

Date prepared

8/6/72

Date received

7/28/71

Received from (name or symbol number)

[Redacted] *

Received by

Steven L. Christensen

Method of delivery (check appropriate blocks)

in person by telephone by mail orally recording device written by Informant

If orally furnished and reduced to writing by Agent:

Date

Dictated _____ to _____

Transcribed _____

Authenticated by Informant _____

Date of Report

7/28/71

Date(s) of activity

7/28/71

Brief description of activity or material

Info re NSWPP

File where original is located if not attached

* INDIVIDUALS DESIGNATED BY AN ASTERISK (*) ONLY ATTENDED A MEETING AND DID NOT ACTIVELY PARTICIPATE. VIOLENCE OR REVOLUTIONARY ACTIVITIES WERE NOT DISCUSSED.

Information recorded on a card index by _____ on date _____

Remarks:

157-28 (NSWPP)
100-14297 (Davis)
157-1816 (Photo)
170-286A-116

Pertinent info previously disseminated.
Index (FNU) Ref to 157-28.

cf

Block Stamp

170-286A-116
SEARCHED _____ INDEXED _____
SERIALIZED _____ FILED _____
JAN 6 1972
FBI - SAN DIEGO
[Signature]

July 28, 1971

By JEROME

It has come to my attention that one of the ~~main~~ NSWPP organizers in San Diego County is a person named (FNU) ROTH. He has been described as a uniformed and card carrying member of the Nazi Party and has allegedly done much organizing for that group in the Oceanside, California, area.

I have also learned that SAM DAVIS and JIM POTO have been asked to go to Arizona within the next few weeks to meet with some unnamed person there.

Jerome

Date prepared

1/7/72

Date received

7/26/71

Received from (name or symbol number)

[Redacted] *

Received by

Steven L. Christensen

Method of delivery (check appropriate blocks)

in person by telephone by mail orally recording device written by Informant

If orally furnished and reduced to writing by Agent:

Date

Date of Report

7/26/71

Dictated _____ to _____

Transcribed _____

Authenticated by Informant _____

Date(s) of activity

7/25/71

Brief description of activity or material

Info re San Diego, NSWPP
Frank Yakofec

File where original is located if not attached

* INDIVIDUALS DESIGNATED BY AN ASTERISK (*) ONLY ATTENDED A MEETING AND DID NOT ACTIVELY PARTICIPATE. VIOLENCE OR REVOLUTIONARY ACTIVITIES WERE NOT DISCUSSED.

Information recorded on a card index by _____ on date _____

Remarks:

170-286A-141

100-14297 (Davis)

157-28 (NSWPP)

100-14303 (Watson)

~~100~~ 157-1820 (Yakofec)

157- (Robert S. Mayer) (new) GKA

52-5212 (Ron Zarick)

100-14819 (Godfrey)

100-15356 (Hooder)

Relevant info previously furnished handled. Index Bill Gullette to 52-5212. Dr. Dunkley to 100-15356

1/20/72
SAC Christensen was instructed to expedite prep. of FD-306's and to see me if there are other problems pertinent to prep. Christensen advised to promptly disseminate all pertinent info to local and other offices (VSS) and to follow procedure in 176-26-103.

Block Stamp

170-286A-117

SEARCHED [] INDEXED []
SERIALIZED [] FILED []
JAN 1 1972
FBI - SAN DIEGO
Christensen [initials]

July 26, 1971

By Jerome

I was in contact with SAM DAVIS again yesterday and he mentioned again his favorite project which is to fill some rifle grenades with thermite and explosives and to fire them onto the top of several gasoline and oil storage tanks, among those which are located in Mission Valley near the intersection of Murphy Canyon Road and Firars Road. He said he believes the results will be spectacular and that he will not permanently leave the San Diego area without completing this project.

DAVIS continues to be extremely interested in the local Nazi Party group and said he wants to work for a high position in this organization. He says that VIC WALTON is deeply involved in the NSWPP, but even though, he still does not trust WALTON. He said he is going ahead with plans to locate and rent office space for the NSWPP and also set up a printing press for that group.

DAVIS also talked about another plan which is being worked on to attempt to seize a Viet Cong flag which is hanging in an office at UCSD. He said at least he would like

to make an effort to put a smoke grenade through the window of this office. He said he has been talking with the NSWPP about taking 15 members of that group along to protect the person who would fire this rifle grenade through the window. He said the results would be better yet if a high explosive grenade was used. He advised that the NSWPP and others he is associated with are suppose to have some LAWs (Light Anti-tank Weapons) which they might use.

FRANK YACOPEC has been fired again. He now has a boarder living with him who was recently discharged from the Marine Corps. This individual is named ROBERT S. MAYER. He claims to be well acquainted with the firearm ranges at Camp Pendleton and knows of an ammo dump there which he says has only one guard who could easily be over-powered, and that, by using a two ton truck, it would be possible to take over a million rounds of ammo from this location. MAYER also claims to have a .45 caliber Thompson sub-machine gun, and M-16 and M-14 rifles which he would sell.

BILL GUIETTE, who runs the Bullseye Gun Store was set up in that business by his father who is a Sergeant with the San Diego Police Department. GUIETTE was telling me today that he was at RON ZARICK's house a few days ago and saw there many parts for various machine guns. Yesterday SAM DAVIS said he was at ZARICK's house some time ago

and while there, saw a M-14 rifle, a water-cooled .30 caliber machine gun and a BAR.

DAVIS claims that he is somewhat upset with BARRY GODFREY, as he gave GODFREY an assignment to watch the San Diego FBI Office to obtain information regarding the activities of the local FBI. DAVIS said he might use GEORGE HOOVER to stake out the FBI Office if he is presently out of work on a fake back injury. The disability chits and this fake injury were signed by Dr. DUNKLEY in El Cajon, who has agreed to take care of any MM or other right wing individual wounded in a confrontation the Left or with law enforcement agencies without filing the necessary reports and without charging a fee. HOOVER is suppose to go back to work Monday. DAVIS says he has another man (unidentified) who has a camera with a tele-photo lense, who will be assigned to take photographs of various places of interest to DAVIS.

DAVIS claims that the Nazis want to start conducting raids on local Jewish synagogues and want to start looking up information and planning tactics to taken against the JDL and the ADL.

Date prepared
1/24/72

Date received
9/9/71

Received from (name or symbol number)
[Redacted] *

Received by
SA Steven L. Christensen

Method of delivery (check appropriate blocks)
 in person by telephone by mail orally recording device written by Informant

If orally furnished and reduced to writing by Agent:
Date _____
Dictated _____ to _____
Transcribed _____
Authenticated by Informant _____

Date of Report
9/9/71
Date(s) of activity

Brief description of activity or material
Info re activities of Godfrey,
Bill Clay, Davis, Hoover, McBride
NSWFF

Current
File where original is located if not attached
170-286

* INDIVIDUALS DESIGNATED BY AN ASTERISK (*) ONLY ATTENDED A MEETING AND DID NOT ACTIVELY PARTICIPATE. VIOLENCE OR REVOLUTIONARY ACTIVITIES WERE NOT DISCUSSED.
 Information recorded on a card index by _____ on date _____

Remarks:
170-286 A-118
157-28 (NSWFF)
100-14819 (Godfrey)
100-14297 (Davis)
100-15356 (Hoover)
~~100-2305 (Clay)~~
100-14610 (McBride)
100-16200 (Calrep)
2 - Los Angeles
2 - Sacramento

Index: National Justice
Foundation to 100-14819.
~~National Industrial Association~~
~~100-14819~~

Block Stamp

170-286-A-118
SEARCHED INDEXED
SERIALIZED FILED
JAN 24 1972
FBI - SAN DIEGO
[Signature]

JEROME

September 9, 1971

In talking with BARRY GODFREY, I learned of the formation of a new organization known as the National Justice Foundation. This organization is supposed to be a group of lawyers from the Los Angeles and Sacramento areas whose purpose will be to counteract the work of the ACLU.

I also learned that the groups which are protesting the sailing of the USS Constellation are going to set up polling booths outside various city polling places and at other locations in an attempt to get people to vote on whether the USS Constellation should sail.

I also was told that the Bishop faction of the Nazi Party is now known as the National Socialist American Workers Party, and is putting out a new newspaper named "Attack". Apparently, this newspaper is being published and printed at Los Angeles, California.

GODFREY also told me he was recently interviewed by a San Diego County Deputy Sheriff named D. Q. MARTIN, regarding GODFREY's involvement in Minuteman and other right wing activities. MARTIN was apparently under the impression that GODFREY was one of the leaders of these activities and would be able to furnish much information as to names, addresses, and activities of other people who are involved. GODFREY denied any knowledge whatsoever of such activities which caused MARTIN to become extremely aggravated and to make some veiled threats against GODFREY. However, he eventually gave up and left. Afterward, GODFREY discussed this matter with SAM DAVIS, MICK HOOVER, and a few other people. It was their feeling that MARTIN's visit to GODFREY was probably caused by BILL CLAY. CLAY has suddenly been around contacting people, asking questions and trying to find out what is going on. CLAY even made a personal appearance at the Gunsmoke Ranch and, while there, apparently caused some friction as HOOVER has now been asked to leave the ranch. The questions in

these people's minds now is whether CLAY has turned informer for the Sheriff's Office and was the source of information for MARTIN regarding GODFREY's activities.

It seems that DAVIS, HOOVER, and STAN MC DADE are now not as interested in the Nazis as they formerly were. However, they will continue to cooperate with that group. DAVIS appears to be very enthusiastic about the coming Republican National Convention. He thinks that this will be his big chance to do something that will be remembered in the world. He said he is working on plans to organize a series of meetings of eight to twelve people to make plans for and obtain pledges of financial support for right wing harassment activities during the convention.

Gerome

Date prepared

1/24/72

Date received

9/13/71

Received from (name or symbol number)

~~XXXXXXXXXX~~ *

Received by

SA Steven L. Christensen

Method of delivery (check appropriate blocks)

in person by telephone by mail orally recording device written by Informant

If orally furnished and reduced to writing by Agent:

Date

Date of Report

9/13/71

Dictated

to

Date(s) of activity

Current

Transcribed

Authenticated by Informant

Brief description of activity or material

Right Wing activities in San Diego + Los Angeles

File where original is located if not attached

170-286

* INDIVIDUALS DESIGNATED BY AN ASTERISK (*) ONLY ATTENDED A MEETING AND DID NOT ACTIVELY PARTICIPATE. VIOLENCE OR REVOLUTIONARY ACTIVITIES WERE NOT DISCUSSED.

Information recorded on a card index by _____ on date _____

Remarks:

~~170-286A-119~~

157-28 (NSWAPP)

100-14297 (Davis)

157-201 (Smith)

100-14303 (Walton)

100-14610 (McDade)

157-1813 (Haughton)

157-2305 (Clay)

2-157- (Walter Guire) (open new) 100-12461-630

2-157- (Edith Guire) (open new)

100-14294 (Clark)

157-1614 (Haughton)

157-2388 (Winchester)

3 - Los Angeles

(1 - LA 157- NSWAPP

1 - LA 157-5565 Scott Winchester Joseph Tomasi

Index: Scott Winchester to 157-28. Joseph Tomasi to 157-28. Ed Boyd to 157-1614.

Block Stamp

170-286A-169

SEARCHED INDEXED SERIALIZED FILED JAN 24 1972 FBI - SAN DIEGO

JEROME

September 13, 1971

I was in contact with SAM DAVIS this morning. He told me that he has joined the Nazi Party and that today he rented Post Office Box 5791, San Diego, California, for the Nazis. He said he has been assigned to act as a Storm Trooper group leader in the San Diego area and has begun actively organizing for the Nazis.

He explained that he went to see SCOTT WINCHESTER at Torrance, California, yesterday. He said he met WINCHESTER at a place named The Bavarian Alpine Village where WINCHESTER's group has relocated. He said that the activities of WINCHESTER's group are very open and that there was a lot of Nazi literature and posters in plain view. He said he observed many people giving the Nazi salute and handing SCOTT WINCHESTER money.

DAVIS said there were several thousand people present at The Bavarian Alpine Village with hundreds of them dancing around outside the Nazi Party headquarters. He said the crowd included many Lithuanians, Estonians, and Arabs, as well as Germans, most of whom appears to be pro-Nazi. DAVIS said one Arab was introduced to him as the leader of the Al Satrah Group at Los Angeles. He said that another person who was introduced to him claimed to have worked for the HITLER Youth SS and was wearing a gold SS ring. DAVIS himself is now wearing a silver SS ring.

I also learned that GERALD L. SMITH and one of his Lieutenants went into the "Peace House" at 2143 Market Street, early last Friday afternoon to get some of their literature. They were dressed in full Nazi uniform and when they went into the house, they found a meeting of about fifty persons in progress.

Their appearance in Nazi uniforms caused a great deal of consternation among those people at the meeting.

Also, it has come to my attention that SAM and his associates have been asked to set up a printing press for the Nazis in Vic Walton's guest house and have taken this request under favorable consideration.

GERALD L. SMITH local Nazi Party Group, the National Socialist White People's Party, is affiliated with the same group at Los Angeles which is run by JOE TOMASSI. DAVIS, however, favors the Nazi Party Group run by SCOTT WINCHESTER at Los Angeles, and is working with STAN MC DADE to engineer a switch of SMITH's group from the TOMASSI group to the WINCHESTER group. DAVIS said that MC DADE and SMITH are on very friendly terms.

The Right Wing Activists in the San Diego area have three printing presses. One, which belongs to BETTIE HAUGHTON, is located at the residence of WALT and EDITH GEYER on Massachusetts Avenue in La Mesa. Another, which is owned by BILL CLAY, is located at the residence of HOWARD CLARK at Ramona, California, and the third, which belongs to ED BOYD, TROY HAUGHTON's step-father, is in the possession of STAN MC DADE.

Jerome

Date prepared

1/24/71

Date received

9/20/71

Received from (name or symbol number)

~~XXXXXXXXXX~~ *

Received by

SA Steven L. Christensen

Method of delivery (check appropriate blocks)

in person by telephone by mail orally recording device written by Informant

If orally furnished and reduced to writing by Agent:
Date

Dictated _____ to _____

Transcribed _____

Authenticated by Informant _____

Date of Report

9/20/71

Date(s) of activity

Current

Brief description of activity or material

Info re Right Wing activities in San Diego area.

File where original is located if not attached

170-286

* INDIVIDUALS DESIGNATED BY AN ASTERISK (*) ONLY ATTENDED A MEETING AND DID NOT ACTIVELY PARTICIPATE. VIOLENCE OR REVOLUTIONARY ACTIVITIES WERE NOT DISCUSSED.

Information recorded on a card index by _____ on date _____

Remarks:

- 170-286A-120
- 100-14297 (Dasis)
- 100-14294 (Clark)
- 100-15336 (Hoover)
- 100-15355 (Busch)
- 100-14610 (Mc Rade)

170-286A-120
Block Stamp

Handwritten mark

SEARCHED _____ INDEXED _____
 SERIALIZED _____ FILED _____
 JAN 24 1971
 FBI - SAN DIEGO
Handwritten signature

JEROME

September 20, 1971

I was in contact with SAM DAVIS last night. I learned from him that HOWARD CLARK is driving a new light colored Pickup Truck with a camper shell on it. Furthermore, GEORGE HOOVER is now living with JERRY BUSCH. BUSCH lives with his mother in an apartment house at the corner of McLintock and El Cajon Boulevard. This apartment house is the first one on the right as you go north on McLintock. BUSCH's apartment is the upper rear.

I also learned that STAN MC DADE has leased a cabin somewhere on Mt. Palomar to be used as a hideout if necessary.

Jerome

Date prepared

1/24/72

Date received

9/16/71

Received from (name or symbol number)

~~XXXXXXXXXXXX~~ *

Received by

SA Steven L. Christensen

Method of delivery (check appropriate blocks)

in person by telephone by mail orally recording device written by Informant

If orally furnished and reduced to writing by Agent:

Date

Dictated _____ to _____

Transcribed _____

Authenticated by Informant _____

Date of Report

9/16/71

Date(s) of activity

Current

Brief description of activity or material

Info re Right Wing activities in San Diego area

File where original is located if not attached

170-286

* INDIVIDUALS DESIGNATED BY AN ASTERISK (*) ONLY ATTENDED A MEETING AND DID NOT ACTIVELY PARTICIPATE. VIOLENCE OR REVOLUTIONARY ACTIVITIES WERE NOT DISCUSSED.

Information recorded on a card index by _____ on date _____

Remarks:

- 170-286A-121
- 100-14297 (Davis)
- 100-14819 (Godfrey)
- 157-1820 (Yakofee)
- 157-1813 (Haughton)
- 157-2815 (SAO)

Index O.A. Alexander to 157-2815.

Block Stamp

170-286A-121

SEARCHED INDEXED

SERIALIZED FILED

JAN 24 1972

FBI - SAN DIEGO

W

JEROME
September 16, 1971

I was in contact with SAM DAVIS yesterday and he was explaining to me some of the plans he has for the new organization he is trying to establish. He said he wants to try and have the application forms and some of the training materials printed this weekend. He also said he will get a new San Diego post office box tomorrow. There will be two membership lists maintained which will be recorded on microfilm so they will be easy to hide. One of these lists will be kept by DAVIS and the other will be held by BARRY GODFREY. There will be monthly literature mailouts with DAVIS and GODFREY responsible for the mailouts on alternate months. However, the mailouts will be made from GODFREY's house. The supplies for the mailouts and other materials are to be kept in FRANK YACOPEC's attic.

SAM said that BETTIE HAUGHTON has a large quantity of training literature and other supplies in her possession which he will attempt to obtain from her. He said that ALEX (LNU) of Alex Rapid Print has agreed to donate a part of the printing costs for this literature.

In addition, DAVIS said that when the organization gets going specialized training tapes will be made up for advanced trainees. He said he thinks that when the organization is in full swing the literature mailouts and training aids will cost at least \$100 a month.

Jerome

Date prepared

1/24/72

Date received

9/28/71

Received from (name or symbol number)

[Redacted] *

Received by

SA Steven H. Christensen

Method of delivery (check appropriate blocks)

in person by telephone by mail orally recording device written by Informant

If orally furnished and reduced to writing by Agent:

Date

Dictated _____ to _____

Transcribed _____

Authenticated by Informant _____

Date of Report

9/28/71

Date(s) of activity

Current

Brief description of activity or material

Info re Right Wing activities in San Diego Area

File where original is located if not attached

190-286

* INDIVIDUALS DESIGNATED BY AN ASTERISK (*) ONLY ATTENDED A MEETING AND DID NOT ACTIVELY PARTICIPATE. VIOLENCE OR REVOLUTIONARY ACTIVITIES WERE NOT DISCUSSED.

Information recorded on a card index by _____ on date _____

Remarks:

170-286A-122
100-14297 (Davis)
2-157- (Roger Drapeau) (open news)
100-14294 (Clark)

170-286A-122
Block Stamp

SEARCHED INDEXED
SERIALIZED FILED
JAN 1972
FBI - SAN DIEGO
[Handwritten signatures and initials]

JEROME
September 28, 1971

Early this morning, I was contacted by SAM DAVIS who was looking for someone to help him with a project. I told him I had other commitments for the day and he said he would try to find someone else to help him. Later on, I talked to him again and he told me he had wanted someone to help him to move several hundred pounds of explosives from the residence of one ROGER (LNU) at 2003 Dartmoor in Spring Valley, California. DAVIS claimed that these explosives included TNT, C-4 Plastic Explosives, and rifle grenades. DAVIS would not even hint as to where these explosives had been moved but did make a statement to the effect "some day we'll have to move the master cache". I got the impression that HOWARD CLARK may have been involved in this project. I understand that the individual named ROGER lived with a Mexican woman and several children at that address. I have never heard of this ROGER before but will try to find out more.

Jerome

Date prepared

1/24/72

Date received

10/8/71

Received from (name or symbol number)

~~XXXXXXXXXX~~ X

Received by

SA Stewart, Christensen

Method of delivery (check appropriate blocks)

in person by telephone by mail orally recording device written by Informant

If orally furnished and reduced to writing by Agent:
Date

Dictated _____ to _____

Transcribed _____

Authenticated by Informant _____

Date of Report

10/8/71

Date(s) of activity

Current

Brief description of activity or material

Info re SAO & other Right Wing activities in San Diego area.

File where original is located if not attached

190-286

* INDIVIDUALS DESIGNATED BY AN ASTERISK (*) ONLY ATTENDED A MEETING AND DID NOT ACTIVELY PARTICIPATE. VIOLENCE OR REVOLUTIONARY ACTIVITIES WERE NOT DISCUSSED.

Information recorded on a card index by _____ on date _____

Remarks:

- 190-286A-123
- 100-16342 (Rick Burns)
- 100-14159 (Dr. George Abbott) ~~(Dr. George Abbott)~~
- 100-15463 (Herbert Aaron Gindler)
- 100-14610 (McDade)
- 157-2815 (SAO)
- 100-15356 (Hoover)
- 100-15355 (Busch)
- 100-14297 (Davis)
- 100-14819 (Godfrey)

170-286-A-123
Block Stamp

SEARCHED INDEXED
SERIALIZED FILED
JAN 24 1972
FBI - SAN DIEGO
[Signature]

JEROME
October 8, 1971

It has come to my attention that the individual I told you about previously named RICK BURNS, who is a fireman at San Diego Fire Department Station Number 13 in La Jolla, continues to make extremely sympathetic statements about communism in Russia and China. In addition, while at work, he always has a copy of the "Docr" or the "Street Journal" with him. I was also told that he was observed writing the name of Dr. GEORGE ABBOTT and telephone number 488-4421 and the name HERBERT GINDLER on the wall at the fire station near the telephone.

I was in contact with STAN MC DADE earlier today. He said he has had one thousand copies of the new membership application form for the Secret Army Organization printed up as well as a large number of copies of letterhead stationery for the group. The membership initiation fees to join the organization will be \$5 and there will be a \$3 per month dues assessed for each member. MC DADE said he believes he will join the organization.

I learned that GEORGE HOOVER, who is out of work, is now receiving unemployment payments. He also allegedly been on some of the local reservations attempting to recruit Indians to help work in opposition to the Leftists.

I also found out that SAM DAVIS, HOOVER and JERRY BUSCH have been talking about committing robberies of houses of prostitution and similar establishments where there would be little likelihood of the theft being reported. The purpose of these robberies, of course, is to obtain money to finance right wing activities.

Lastly, I learned that BARRY GODFREY is supposed to see SAM DAVIS this afternoon and furnish him with 3,500 rounds of .45 and .223 caliber ammunition.

Done

Date prepared

1/24/72

Date received

10/20/71

Received from (name or symbol number)

~~XXXXXXXXXX~~ *

Received by

SA Steven L. Christensen

Method of delivery (check appropriate blocks)

in person by telephone by mail orally recording device written by Informant

Orally furnished and reduced to writing by Agent:

Date

Date of Report

10/20/71

Dictated _____ to _____

Date(s) of activity

Transcribed _____

Authenticated by Informant _____

Covered

Brief description of activity or material

Info re Right Wing activities at San Diego; Yuma, Arizona Gun Shows; SAO

File where original is located if not attached

170-286

INDIVIDUALS DESIGNATED BY AN ASTERISK (*) ONLY ATTENDED A MEETING AND DID NOT ACTIVELY PARTICIPATE. OFFENSE OR REVOLUTIONARY ACTIVITIES WERE NOT DISCUSSED.

Information recorded on a card index by _____ on date 157-2677

marks:

- 170-286A-124
- 157-2815 (SAO)
- 157-1813 (Haughton)
- 157- (Walter A. Gaire)
- 157-14297 (Davis)
- 157-14819 (Galtrey)
- 157- (Robert S. Mayer)
- 157-14610 (Mc Dade)
- 157-14301 (Rustinger)
- 157-1816 (Poto)
- 157-15356 (Hoover)
- 157-15355 (Busch)
- 157-28 (NSWPP)
- 157-201 (Smith)
- 157-2177 (Forrest)

Index: Bill Guette, Terry Brown, Charles Kinneil, (FNU) McGill, Ralph Humphreys, Tom Webster, Lannie Reed, Dick Geise, Granny Martin, Cy Anderson to 157-2815.

Block Stamp

170-286A-124

SEARCHED INDEXED
SERIALIZED FILED

JAN 27 1972
FBI - SAN DIEGO

Christensen

~~157-2832 (H. S. ...)~~

100-14807 (Geyer)

157-2832 (Carey)

157-1820 (Yakobec)

2 - Las Vegas

2 - Los Angeles

2 - Seattle

2 - Phoenix

REPORT BY JEROME

October 20, 1971

Attached is a copy of the new letterhead stationery of the Secret Army Organization (SAO). This letterhead was printed approximately two weeks ago along with a large number of sheets which are information bulletins and a so-called history of the organization. Some stickers advertising for support of the SAO were printed about one week later. All of the printing has been done on BETTY HAUGHTON's offset press either by her or by WALT GUYER.

In line with the decision to go ahead and set up the SAO organization, SAM DAVIS and BARRY GODFREY have been out contacting people in an attempt to get new recruits. So far, FRANK YACOPEC, PAUL RUPLINGER, ROBERT MAYER, STAN MC DADE, and JAMES EVAN POTO have been approached and appear to be reasonably disposed to joining the new organization. Two other individuals, GEORGE HOOVER and JERRY LEE BUSCH, apparently are not to know about the organization for the time being. However, they have been asked to do some intelligence-type investigations and reports on some random Left Wing activities which are involved in the project to attempt to keep the USS Constellation from sailing on 11/1/71. So far, they have turned in one report, which I gather was beautifully done, typed and dealt with the layout of the building involved, its occupants, the police coverage, and other areas of interest. HOOVER and BUSCH are supposed to be busy at the present time on a similar report on another groups.

In addition to the individuals named above, there are probably several other people in the San Diego area who would be supporters of, or sympathetic, to the SAO who have not yet been officially contacted.

As previously reported, SAM DAVIS and GEORGE HOOVER and STAN MC DADE were very much interested in joining the local Nazi group, the National Socialist White Peoples Party (NSWPP). However, they recently discovered that the official Nazi Party policy is very much anti-American Indian and they are now very disenchanted with the Nazis as DAVIS is one-quarter Indian and HOOVER is one-half Indian. In addition, this policy has cost GERALD L. SMITH one of his best

lieutenants (name not known). This person was living with a girl who is part Indian and when SMITH ordered him to stop seeing her, he left the organization instead. It is possible that he may join the SAO.

This interesting turn of events may have been one of the important factors which caused DAVIS to try and get the SAO off the ground.

Many of the SAO organizational histories and news bulletin sheets have been sent out and are being sent out to other people who have been known in the past to be Right Wing sympathizers.

Those individuals from the San Diego area known to be Right Wing sympathizers who attended the recent gun show at Yuma, Arizona, included the following:

STAN MC DADE

SAM DAVIS

BARRY GODFREY

BILL GUIETTE

TERRY BROWN

CHARLES KINNEL

JERRY GUYER

(FNU) MC GILL

TOM FORREST

DON CAREY

RALPH HUMPHREYS

WAYNE HUMPHREYS (son of RALPH)

TOM WEBSTER

LANNIE REED

DICK GEISE

GRANNY MARTIN

and others.

CY ANDERSON, from ^{Everett} someplace in the Seattle, Washington, area, as well as ~~EDWARD~~ MOORE and his wife, who are identified as Miami leaders in the Phoenix, Arizona, area, were also in attendance.

In addition, the Angriff Press (DON SISCO's group) was well represented and had set up a table on which were being sold all kinds of manuals and literature on explosives and incendiaries. They were also selling blasting cap crimpers and American Nazi Party Christmas cards.

The people sponsoring the gun show expected only about 200 individuals to show up. However, there were 200 tables set up, on many of which two persons were displaying their merchandise, plus many spectators for a total of at least 500 individuals at the show. Included among these were many Yuma County Sheriffs and city police officers who were taking an active part in the show. I believe some ATFD Agents showed up at the show but were afraid to make any arrests or take any other action due to the large numbers of people at the show and the obvious lack of support they were getting from the local law enforcement officers. I honestly believe there would have been a big shootout if the ATFD Agents had attempted to take any kind of action such as make an arrest or seize some piece of merchandise. Most of the people at the show seemed to be in a very bad mood toward the ATFD.

One of the hottest items at the show was .50 caliber machine gun ammunition. BILL GUIETTE took a large quantity of this ammunition to sell and got rid of all of it. There was a Pro-nationalist Chinese individual there, who was well known to CY ANDERSON, who was buying all the .50 caliber ammunition and magazines and parts he could get. I was told that he is supposed to be filthy rich and to have a stupendous arsenal located on his ranch somewhere in Southern Arizona.

Following the gun show, a meeting involving ^{Everett} ~~EDWARD~~ MOORE, CY ANDERSON, SAM DAVIS, MC DADE and GODFREY was held to discuss the SAO. The news bulletin and history sheets of

the SAO were passed around and MOORE and ANDERSON agreed that their respective groups would join in with the SAO as they felt that some cohesion among Right Wing groups has become necessary due to the power vacuum left by the Minuteman organization.

After the show, SAM DAVIS drove to Las Vegas, Nevada to contact some people there, among them a person named JACK DOYLE who is supposed to have Mafia connections, to determine if they were interested in the SAO and, if so, what support or assistance they can give.

En route to the gun show, CY ANDERSON broke down somewhere in Nevada and he had been forced to hire someone to bring him on to the gun show. After the show, he rode back to the location of his automobile with SAM DAVIS.

ANDERSON brought with him to the gun show a number of U.S. Navy survival kits, some Army sleeping bags, an AR 180 rifle in a .223 caliber and some miscellaneous gun parts for the KARNEs of AR sales at Los Angeles, California, who were also at the show. ANDERSON appeared to be good friends of the KARNEs.

While at the gun show, ANDERSON was overheard to state that his group had recently lost 5,000 feet of primacord and 10 machine guns in a raid by the ATFD on a friend's house. ANDERSON said he was not too concerned about the machine guns but he really hated to lose all of that Primacord. It was learned that ANDERSON supposedly has a blaster's permit with which he can obtain most of the commercially available explosives that he wants. ANDERSON said he was going to stay in the Sathwest party of the country for about two weeks to make contact with people he knows. He said the last week of this two-week period would be spent in San Diego helping to get the SAO started.

In addition, he indicated he probably would return to the San Diego area in about two months at which time he would bring more weapons to sell.

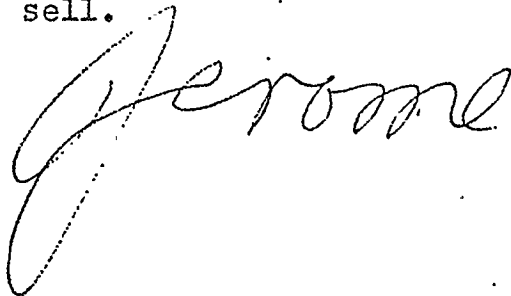
A large, stylized handwritten signature in cursive script, appearing to read "Jerome". The signature is written in dark ink and is positioned in the lower right quadrant of the page, below the main body of text.

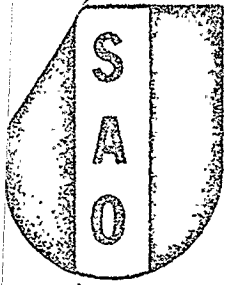

SECRET ARMY ORGANIZATION

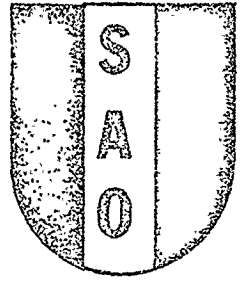

Date prepared

1/24/72

Date received

10/26/71

Received from (name or symbol number)

[Redacted] *

Received by

SA Steven L. Christensen

Method of delivery (check appropriate blocks)

in person by telephone by mail orally recording device written by Informant

If orally furnished and reduced to writing by Agent:

Date

Dictated _____ to _____

Transcribed _____

Authenticated by Informant _____

Date of Report

10/26/71

Date(s) of activity

Current

Brief description of activity or material

Info re Right Wing Activities
in San Diego area.

File where original is located if not attached

170-286

* INDIVIDUALS DESIGNATED BY AN ASTERISK (*) ONLY ATTENDED A MEETING AND DID NOT ACTIVELY PARTICIPATE. VIOLENCE OR REVOLUTIONARY ACTIVITIES WERE NOT DISCUSSED.

Information recorded on a card index by _____ on date _____

Remarks:

170-286A-125
100-14297 (Davis)
157-2815 (SFO)
157-28 (NSWPP)
100-15356 (Hoover)

Index: by Anderson to
157-2815.

2 - Seattle

Block Stamp

170-286A-125
SEARCHED INDEXED
SERIALIZED FILED
JAN 24 1972
FBI - SAN DIEGO
[Signature]

JEROME
October 26, 1971

SAM DAVIS called last Saturday night to tell me he had finally returned to San Diego. He said he got more involved at Las Vegas in organizing and contacting people than he had expected to. It looks as though some of the people he met at Las Vegas will be joining the SAO group. This morning, we are supposed to go to all of the post office boxes and see if there has been any response to the mailing out of the first literature on the SAO. We also are going to order insignia patches to be sewn on the berets that SAO members will wear. These patches will be obtained through CY ANDERSON at Seattle, Washington. SAM also wants to start work on organizing some urban Guerilla warfare squads. He said he wants to form these squads with six men to a squad and two cars to a squad.

I also learned from him that there will be a White Power rally in Balboa Park on October 30, 1971. This rally will be sponsored by the local Nazi Group.

I am also supposed to go with GEORGE HOOVER this afternoon to help him begin recruiting his six man squad.

Jerome

Date prepared

1/24/72

Date received

10/27/71

Received from (name or symbol number)

~~XXXXXXXXXX~~ *

Received by

SA Steven H. Christensen

Method of delivery (check appropriate blocks)

in person by telephone by mail orally recording device written by Informant

If orally furnished and reduced to writing by Agent:

Date

Dictated _____ to _____

Transcribed _____

Authenticated by Informant _____

Date of Report

10/27/71

Date(s) of activity

Current

Brief description of activity or material

Info re Right Wing activities
in San Diego Area

File where original is located if not attached

170-286

* INDIVIDUALS DESIGNATED BY AN ASTERISK (*) ONLY ATTENDED A MEETING AND DID NOT ACTIVELY PARTICIPATE. VIOLENCE OR REVOLUTIONARY ACTIVITIES WERE NOT DISCUSSED.

Information recorded on a card index by _____ on date _____

Remarks:

- 170-286A-111
- 100-15356 (Hoover)
- 100-15355 (Busch)
- 100-14610 (McDade)
- 100-14297 (Davis)
- 100-14819 (Godfrey)
- 157-2815 (SAO)
- 157-2177 (Forrest)
- 157-2921 (Zarick)
- 157-1816 (Poto)

Index: Cy Anderson,
Jack Doyle, ~~Forrest~~
~~McDade~~ to 157-2815
157-2831 - Everett Holt

- 2 - Las Vegas
- 2 - Phoenix
- 2 - Seattle
- 2 - Los Angeles

Block Stamp

170-286A-126

SEARCHED INDEXED
SERIALIZED FILED

JAN 11 1972
FBI - SAN DIEGO

[Handwritten signatures and initials]

JEROME
October 27, 1971

I was in contact with GEORGE HOOVER yesterday afternoon. He said that the Nazi sponsored White Power rally will be held in Balboa Park at the House of Hospitality on October 30, 1971, a Saturday, at noon. He said he and some of his associates have been thinking of directing some incident against the United Nations Building in Balboa Park in retaliation for recent actions taken by the United Nations with regard to Nationalist China. He said some of the things that have been considered are picketing the United Nations Building in the park, entering the building and taking down the United Nations flag and burning it. People who might be involved in this incident if it takes place would be HOOVER, JERRY BUSCH, and some of the Nazi Party members. They may attempt to draw supporters for this incident from the White Power rally which will take place the previous day. HOOVER was also talking about trying to get some members of the Chinese-American Association down to help.

HOOVER and STAN MC DADE are presently on a religious organization kick and are associated with the Missionary Church of Jesus Christ run by Reverend GALE at Los Angeles. They have acquired some fancy blue uniforms to go along with their involvement in this group. I understand that SAM DAVIS and BARRY GODFREY have decided to stay away from this group.

The individuals with whom SAM DAVIS was in contact at Las Vegas are JACK DOYLE, telephone number 642-4467, and ED (LNU), post office box 2191, Las Vegas, telephone number 384-2046.

CY ANDERSON, who has been in Texas since he went to Las Vegas with SAM DAVIS from the Yuma gun show, is supposed to be in town this Friday afternoon. I have learned that he is an old friend of RON ZARICK and TOM FORREST. I also learned that SAM DAVIS and BARRY GODFREY want to go to the

Phoenix gun show in December for the purpose of making contact with EV MOORE.

It has also come to my attention that JIM POTO has lost a lot of weight and also has joined the SAO.

Jerome

Date prepared

1/25/72

Date received

10/28/71

Received from (name or symbol number)

[Redacted] X

Received by

SA Steven L. Christensen

Method of delivery (check appropriate blocks)

in person by telephone by mail orally recording device written by Informant

If orally furnished and reduced to writing by Agent:

Date

Date of Report

10/28/71

Dictated _____ to _____

Date(s) of activity

Transcribed _____

Authenticated by Informant _____

Current

Brief description of activity or material

Info re Right Wing activities
in San Diego area

File where original is located if not attached

SD 170-286

* INDIVIDUALS DESIGNATED BY AN ASTERISK (*) ONLY ATTENDED A MEETING AND DID NOT ACTIVELY PARTICIPATE. VIOLENCE OR REVOLUTIONARY ACTIVITIES WERE NOT DISCUSSED.

Information recorded on a card index by _____ on date _____

Remarks:

- 170-286A-127
- 100-15356 (Hoover)
- 100-15355 (Busch)
- 157-2921 (Zavick)
- 100-1246-4 (Melvin Crain)
- 157-549⁵⁴⁴ (Nower)
- 100-14299 (Davis)
- 157-2815 (SAD)
- 157-2177 (Forrest)

Index: Cy Anderson to 157-2815

2-Seattle

Block Stamp

170-286A-127

SEARCHED INDEXED

SERIALIZED FILED

JAN 6 1972

FBI - SAN DIEGO

C. [Signature]

JEROME
October 28, 1971

I was in contact with RON ZARICK earlier today. He claimed that he had some explosives he wanted to sell and asked if I was interested.

I also understand that there were some spies, probably GEORGE HOOVER and JERRY BUSCH, watching ROD BURTON's house at 1511 29th Street, yesterday. Apparently, some kind of meeting was taking place there and one man had been stationed out front as a watchman. Automobiles known to belong to MELVIN CRAIN and LEON NOWER were observed parked at the residence.

A person I have mentioned before, CY ANDERSON, will be at SAM DAVIS' house tomorrow. It is my understanding that ANDERSON was originally introduced to DAVIS by TROY HAUGHTON. Furthermore, I was told that SAM DAVIS met TOM FORREST through CY ANDERSON. It looks as though ANDERSON may be one of the biggest right wing operators and dealers in firearms in the west. The trip which ANDERSON made to Texas actually took him to El Paso. He apparently made contact there with several individuals whose identities are known to DAVIS but who would not divulge them to me.

The following is a rough physical description of CY ANDERSON:

Race	White
Sex	Male
Height	6'2" - 6'4"
Weight	approximately 275 pounds
Build	large
Age	30 to 35 years
Eyes	Blue
Hair	Blond and worn in a butch hair cut
Complexion	Pale
Marital status	Married (his wife was with him at the Yuma gun show)
Occupation	Probably a mechanic

Jerome

Date prepared

1/25/72

Date received

11/4/71

Received from (name or symbol number)

[Redacted] *

Received by

SA Steven L. Christensen

Method of delivery (check appropriate blocks)

in person by telephone by mail orally recording device written by Informant

If orally furnished and reduced to writing by Agent:

Date

Date of Report

11/4/71

Dictated _____ to _____

Date(s) of activity

Transcribed _____

Authenticated by Informant _____

Current

Brief description of activity or material

Right Wing activities in San Diego area

File where original is located if not attached

SD 170-286

* INDIVIDUALS DESIGNATED BY AN ASTERISK (*) ONLY ATTENDED A MEETING AND DID NOT ACTIVELY PARTICIPATE. VIOLENCE OR REVOLUTIONARY ACTIVITIES WERE NOT DISCUSSED.

Information recorded on a card index by _____ on date _____

Remarks:

770-286A-128

100-15356 (Harver)

100-15355 (Busch)

159-14616 (Stanley Don McDade)

159-28 (NSWPP)

2 - Los Angeles

170-286A-128
Block Stamp

SEARCHED INDEXED
SERIALIZED FILED
JAN 25 1972
FBI - SAN DIEGO
Christensen

JEROME
November 4, 1971

I have learned from GEORGE HOOVER, STAN MC DADE, and JERRY BUSCH attended a meeting of GERALD L. SMITH's Nazi Group last night. As I mentioned before, HOOVER has become involved in the activities of a semi-religious group named the Missionary Church of Jesus Christ. This group is run by a Reverend GALE at Los Angeles, California. GALE claims to be a retired Colonel and a former aid to General MC ARTHUR. GALE comes from Los Angeles to San Diego to speak approximately once a month. He is very anti-semitic and has Nazi tendencies although I doubt he belongs to any Nazi organization. HOOVER is in the process of trying to get himself ordained as a minister of this church. He has made himself up a fancy blue uniform which he wore to the Nazi Party meeting and, apparently, so impressed the other members of the group at the meeting, that many of them wanted to join HOOVER's group, as he had a better uniform than the Nazi uniform. This has apparently caused SMITH a great deal of consternation and he is now busily trying to re-organize his group.

I went by the "Peace House" last night and took a peek through the windows. No one seemed to be home and I observed the house to be stacked full of literature and other printed materials.

Jerome

UNITED STATES GOVERNMENT

Memorandum

TO : SAC, SAN DIEGO (157-new)

FROM : SA STEVEN L. CHRISTENSEN

SUBJECT: LOUIS RAYMOND CONDE
EM - WIG

DATE: 1/31/72

On 1/28/72, ~~Source~~ advised he and JERRY LYNN DAVIS had gone that morning to the Subject's residence at 4930 Academy in the ~~Gaslamp~~ area of San Diego. Purpose of the visit was to solicit financial support for the SAO from CONDE. CONDE agreed to furnish such, along with other assistance and contacts, in return for SAO support in his campaign for the seat on the County Board of Supervisors which is now held by WALTER SHIDFILL (PH). One form of support SAO will give is to print campaign literature for CONDE on its printing presses. Source said CONDE has the support of both the La Jolla Town Council and the Clairmont Town Council in his campaign, and is well thought of in Republican Party circles for his campaign efforts in behalf of Governor RONALD REAGAN.

It is noted that when first contacted, source asked the writer if he was acquainted with a former FBI Agent named BOB SUNDQUIST or something similar to that name. Writer asked source if SUNDQUIST was close enough and source replied that was the name he had in mind. He explained that in the conversation with CONDE, he mentioned he had been obtaining information from SUNDQUIST for the benefit of Right Wing activists. Source said CONDE then took two checks from his desk and showed them to source and DAVIS. Source observed the amount on one of the checks was \$200.00. CONDE indicated SUNDQUIST had become indebted to him at an undetermined time in the past for a considerable sum of money and had attempted to pay him off with worthless checks. CONDE said he had used the threat of exposure or prosecution as alver over SUNDQUIST to force him to furnish information.

Source advised he was not aware of the total amount of money owed CONDE by SUNDQUIST, the period of time involved, or the nature of the relationship between the two. He said he was impressed that CONDE had gained this advantage

- 2 - 157-new (LOUIS RAYMOND CONDE)
 - 1 - 157- (JERRY LYNN DAVIS)
 - 1 - 157-286A
- SLC/slc

157-286A-125

SEARCHED	INDEXED
SERIALIZED	FILED
FBI - San Diego	

an

over SUNDQUIST prior to the time of the latter's retirement from the FBI. He did not know the nature of the information furnished, if any, to CONDE.

Source said CONDE then told them that SUNDQUIST is presently working for him, apparently doing some type of boat repair work. It was source's understanding that SUNDQUIST is doing some work on CONDE's personal boat. He said he does not know exactly where SUNDQUIST works or for how long he has been so employed.

Source stated he expects he and DAVIS to maintain close contact with Subject for the furtherance of the SAO. He said he would be alert for any additional information pertaining to this matter.

Date prepared

2/2/72

Date received

11/9/71

Received from (name or symbol number)

~~XXXXXXXXXX~~ X

Received by

SA Steven L. Christensen

Method of delivery (check appropriate blocks)

in person by telephone by mail orally recording device written by Informant

If orally furnished and reduced to writing by Agent:

Date

Dictated _____ to _____

Transcribed _____

Authenticated by Informant 2/2/72

Date of Report

11/9/71

Date(s) of activity

Current

Brief description of activity or material

Information re SAO, Stan McDade,
NSWPP, Frank Yacopac, Robert
Mayer, Cy Anderson, Sam Davis

File where original is located if not attached

* INDIVIDUALS DESIGNATED BY AN ASTERISK (*) ONLY ATTENDED A MEETING AND DID NOT ACTIVELY PARTICIPATE. VIOLENCE OR REVOLUTIONARY ACTIVITIES WERE NOT DISCUSSED.

Information recorded on a card index by _____ on date _____

Remarks:

- 157-2815 (SAO)
- 170-286A-131
- 157-2305 (Clay)
- 157-2393 (McDade)
- 157-2610 (Wakefield)
- 157-201 (Smith)
- 157-28 (NSWPP)
- 157-1820 (Yacopac)
- 157-293 (Mayer)
- 157-3001 (Davis)

Index: Charles Manteve & Cy
Anderson to 157-2815.
157-2815-28

170-286A-131

Block Stamp

SEARCHED INDEXED
SERIALIZED FILED
FEB 1 1972
FBI - SAN LOUIS O

Christensen jll

- 2 - Phoenix
- 1 - 157- (SAO)
- 1 - 157- (Charles Manteve)
- 1 - Seattle
- 1 - 157- (Cy Anderson)

JEROME
November 9, 1971

The SAO has received its first response from the mailouts which were made in October. This came from an individual named CHARLES MANLEVE, 2938 North Seventeen Drive, Phoenix, Arizona, 85015. MANLEVE wrote his letter about two weeks ago expressing interest in the SAO and requesting more information about it.

Incidentally, we are about to lose BILL CLAY's old post office box at the Grossmont Post Office Station. The building where the station is located is to be torn down and the post office boxes are to be vacated by the 26th of this month. It would be helpful to obtain another post office box somewhere else in CLAY's name to facilitate the forwarding of mails.

In talking with STAN MC DADE, I have learned that MICKEY BURTON WAKEFIELD is no longer associated with SMITH's Nazi group. WAKEFIELD is either married to or has been living with a Mexican girl. The official Nazi Party policy is that people with American Indian blood, including Mexicans, are an inferior race and therefore Nazi Party members should have nothing to do with them. I understand that WAKEFIELD was ordered to dump the girl he was living with because of this policy, but refused to do so. Consequently, he either quit or was thrown out of the Nazi Party by SMITH.

MC DADE claimed that this same attitude on the part of the Nazis toward people with Indian blood as well as some other things which have happened has cost SMITH most of the membership of his group. MC DADE said that many of the Nazi Party members had Mexican wives or girlfriends and that SMITH has been telling the members to get rid of them which has created hard feelings.

I was also talking with FRANK YACOPEC and from him learned that his friend, ROBERT MAYER, is quite knowledgeable about radio communications. MAYER has been investigating the broadcasting set up of radio

station KSON. Apparently this station has its broadcast antenna located at some distance from the radio station itself. It has a repeater and amplifier arrangement at the antenna to pick up, amplify, and re-broadcast the relatively weak signal which comes from the radio station. Because of this set up, MAYER claims that with the proper ham radio equipment in a truck or car, most of which he already has, it would be possible for a right wing group to drive this vehicle in the vicinity of KSON's broadcast antenna, jam the signal from the base station, and put out its own fifteen minutes propaganda tape using KSON's broadcast antenna. YACOPEC and MAYER said they are going to work at setting up the necessary equipment to do this.

I have also been talking with SAM DAVIS. He told me that he and CY ANDERSON have made tentative plans for a trip which will start about December 1, 1971. If the trip is made, DAVIS and ANDERSON will meet in San Diego and from there go to Phoenix, Arizona, where they will leave SAM's car. They will then go on to Juarez and Mexico City, Mexico. After returning from Mexico, they will then travel to Denver, Colorado, and also to places in the state of Montana, with the fellow from Las Vegas, Nevada, named ED (LNU). The whole trip is to take two or three weeks and will be made for the purpose of making contacts in the various cities visited with people who are known to them as Right Wing Extremists or dealers in firearms, ammunition, and other equipment.

Gene

Date prepared

2/2/72

Date received

11/10/71

Received from (name, or symbol number)

~~XXXXXXXXXX~~ X

Received by

SA Steven L. Christensen

Method of delivery (check appropriate blocks)

in person by telephone by mail orally recording device written by Informant

If orally furnished and reduced to writing by Agent:

Date

Dictated _____ to _____

Transcribed _____

Authenticated by Informant 2/2/72

Date of Report

11/10/71

Date(s) of activity

Current

Brief description of activity or material

Info re Stan McDade

File where original is located if not attached

* INDIVIDUALS DESIGNATED BY AN ASTERISK (*) ONLY ATTENDED A MEETING AND DID NOT ACTIVELY PARTICIPATE. VIOLENCE OR REVOLUTIONARY ACTIVITIES WERE NOT DISCUSSED.

Information recorded on a card index by _____ on date _____

Remarks:

157-2933 (McDade)
170-286A-132

Block Stamp

170-286A-132
SEARCHED _____ INDEXED _____
SERIALIZED _____ FILED _____
FEB 1 1972
FBI - SAN DIEGO
S. Christensen

JEROME
November 10, 1971

STAN MC DADE is a very miserable and bitter individual. He has a strongly anti-semitic attitude, and blames the U.S. Government and Jewish business people for him being out of work and scraping bottom. He also claims that he has lost all of his friends because of his association with the Nazi Party.

MC DADE is a former merchant ship captain and still holds his masters papers. At one time he also had a large boat and a good boat yard too, but blames Jewish bankers for the loss of these and also for the fact that he cannot get a new business going. However, all he dreams about is going to sea again and getting away from the life on shore. He said he has been offered an eighteen-month contract to sail a ship but thinks he ought to stay home in order to be able to shoot Jews. He said he only stays with his wife because of the children they have but he does not care much for them either.

At one time, MC DADE supposedly was arrested and convicted on a charge of illegal possession of a machine gun. Allegedly, he received a presidential pardon in this connection. He said he thinks that the right wing cause is hopelessly lost and he is so miserable in his life that he actually hopes for a confrontation with the police or with the FBI so that he can end it all in a big shoot out.

Jerome

Date prepared

2/2/72

Date received

11/26/71

Received from (name or symbol number)

[Redacted] *

Received by

SA Steven L. Christensen

Method of delivery (check appropriate blocks)

in person by telephone by mail orally recording device written by Informant

If orally furnished and reduced to writing by Agent:

Date

Dictated

to

Transcribed

Authenticated by Informant

2/2/72

Date of Report

11/22/72

Date(s) of activity

11/21/71

Brief description of activity or material

Info re. Sam Davis, Barry Godfrey,
Roger Drapeau

File where original is located if not attached

* INDIVIDUALS DESIGNATED BY AN ASTERISK (*) ONLY ATTENDED A MEETING AND DID NOT ACTIVELY PARTICIPATE. VIOLENCE OR REVOLUTIONARY ACTIVITIES WERE NOT DISCUSSED.

Information recorded on a card index by _____ on date _____

Remarks:

- 157-3001 (Davis)
- 170-286A-133
- 100-14819 (Godfrey)
- 157-3000 (Drapeau)
- 157-2933 (McDade)
- 157-1614 (Haughton)
- 157-1614 (Haughton)

170-286A-133
Block Stamp

SEARCHED _____ INDEXED _____
SERIALIZED _____ FILED _____
FBI - SHINJIEU
[Handwritten signatures and initials]

JEROME

November 22, 1971

I was talking to SAM DAVIS and BARRY GODFREY at GODFREY's house last night. SAM was asking if we knew where he could find a two and one-half pound block of C-4 plastic explosives, a one-hundred foot roll of fuse, and some fuse-type blasting caps. He said he wanted them for the night of November 22, 1971, but did not say what for. Most likely, he only wants to sell them to someone. He also asked GODFREY if he could provide him with armed cover for the night of November 22, 1971, beginning at about 7:00 p.m. He said he would have to work late as he is building a fence for the Balboa Fence Company at the Rincon, somewhere near Santa Barbara. GODFREY hedged about going along with DAVIS and said he did not know if he could arrange it. DAVIS then said not to worry about it as he could easily get someone else.

Last Sunday, SAM DAVIS, ROGER DRAPEAU, BARRY GODFREY, and STAN MC DADE and his two sons, BRENT and MARK, went out to the desert in DRAPEAU's Van. SAM DAVIS had obtained some maps from BETTIE HAUGHTON, which allegedly showed the locations of some of TROY HAUGHTON's caches of arms, ammunition and other equipment. The particular map that was used Sunday, was hard to read; however, it is believed that the place marked on the map was actually located. The story regarding this particular cache is that several years ago TROY HAUGHTON and some of his companions went on a week long maneuver in the desert near the Banner Grade east of Julian, California. During this week of maneuvers, they supposedly built a cache of weapons and ammunition on the side of a cliff near the highway and made a map to show its location. On Sunday, we found a place where a beautiful hand laid rock wall had been made against the side of a cliff within sight of the Banner Grade Highway. We took the wall down and dug back into the cliff a considerable distance but found nothing. It is the intention of this group to check this site again at a later date with a metal detector.

According to DAVIS, most of TROY HAUGHTON's other caches of arms and ammunition as shown on the other maps he has are in the Needles and Rice, California areas.

Genove

Date prepared

2/2/72

Date received

11/26/71

Received from (name or symbol number)

[Redacted] X

Received by

SA Steven L. Christensen

Method of delivery (check appropriate blocks)

in person by telephone by mail orally recording device written by Informant

Orally furnished and reduced to writing by Agent:

Date

Dictated _____ to _____

Transcribed _____

Authenticated by Informant 2/2/72

Brief description of activity or material

Info re Sam Davis, Cy Anderson
James Poto, Frank Yacopac, Robert
Mayer

Date of Report

11/26/71

Date(s) of activity

Current

File where original is located if not attached

* INDIVIDUALS DESIGNATED BY AN ASTERISK (*) ONLY ATTENDED A MEETING AND DID NOT ACTIVELY PARTICIPATE. VIOLENCE OR REVOLUTIONARY ACTIVITIES WERE NOT DISCUSSED.

Information recorded on a card index by _____ on date _____

Remarks:

- 157-3001 (Davis)
- 170-286A-134
- 157-28 (SAO)
- 157-1816 (Poto)
- 157-1820 (Yacopac)
- 157-2931 (Mayer)

Index: Cy Anderson to 157-3001
157-2815-28

- 1- Seattle
- 1- 157- (Cy Anderson)

Block Stamp

170-286A-134

SEARCHED INDEXED

SERIALIZED FILED

FEB 1 1972

FBI - SEATTLE

[Handwritten signatures]

JEROME
November 26, 1971

I have been in contact with SAM DAVIS. I learned from him that CY ANDERSON resides at 10418 Northeast 168th Place, Bothell, Washington, and has telephone numbers 206-485-4854 and 206-454-8912. His wife's name is DEE.

DAVIS claims that he has already spent \$300 of his personal money on printing and materials for the SAO. He said he is still thinking about a trip to Phoenix, Arizona, Texas, and Mexico.

He also mentioned that JAMES EVAN POTO is getting ready to go to Illinois. He said POTO is working in San Diego for a nation wide chain of restaurants and has been asked to go to Illinois to start a new restaurant somewhere in that state.

I have also talked to FRANK YACOPEC, who said he is going to take a vacation trip to Chicago, Illinois and vicinity in December. He said he would drop by Norborne, Missouri, where the Minutemen Headquarters was located, and put SAO stickers up all over town.

He said he and ROBERT MAYER are working at setting up a little citizens band radio network and will try to provide mobile units to put in the cars of various right wingers. These mobile units will probably be stolen. He said they are also working on a code to use and are still making plans on how to take over radio station KSON's Broadcast Antenna in order to play a right wing propaganda tape.

Jerome

Date prepared

2/2/72

Date received

11/29/71

Received from (name or symbol number)

[Redacted]

*

Received by

SA Steven L. Christensen

Method of delivery (check appropriate blocks)

in person by telephone by mail orally recording device written by Informant

If orally furnished and reduced to writing by Agent:

Date

Dictated _____ to _____

Transcribed _____

Authenticated by Informant 2/2/72

Date of Report

11/29/71

Date(s) of activity

11/29/71

Brief description of activity or material

Info re MIC

File where original is located if not attached

* INDIVIDUALS DESIGNATED BY AN ASTERISK (*) ONLY ATTENDED A MEETING AND DID NOT ACTIVELY PARTICIPATE. VIOLENCE OR REVOLUTIONARY ACTIVITIES WERE NOT DISCUSSED.

Information recorded on a card index by _____ on date _____

Remarks:

100-14427

170-286A-135

170-286A-135

Block Stamp

SEARCHED	INDEXED
SERIALIZED	FILED
FEB - 1 1972	
FBI - SAN DIEGO	

[Handwritten signature]

JEROME

November 29, 1971

I have learned from a contact of mine in the telephone company that the Message Information Center was last located at 2225 A Street, San Diego. However, their telephone at that location was recently disconnected for non-payment. The loss of the telephone service is probably the reason for Message Information Center going out of business.

Jerome

Date prepared

2/8/72

Date received

12/9/71

Received from (name or symbol number)

~~XXXXXXXXXX~~ *

Received by

SA Steven L. Christensen

Method of delivery (check appropriate blocks)

in person by telephone by mail orally recording device written by Informant

If orally furnished and reduced to writing by Agent:
Date

Dictated _____ to _____

Transcribed _____

Authenticated by Informant 2/2/72

Date of Report

12/9/71

Date(s) of activity

Current

Brief description of activity or material

Bill Clay, Sam Davis, Steve McDade, SAO, Bettie Haughton

File where original is located if not attached

* INDIVIDUALS DESIGNATED BY AN ASTERISK (*) ONLY ATTENDED A MEETING AND DID NOT ACTIVELY PARTICIPATE. VIOLENCE OR REVOLUTIONARY ACTIVITIES WERE NOT DISCUSSED.

Information recorded on a card index by _____ on date _____

Remarks:

- 157-2305 (Clay)
- 170-286A-136
- 157-3001 (Davis)
- 157-2933 (McDade)
- 157-1813 (Haughton)
- 157-2815 (SAO)
- 157-3007 (Guire)
- 157-1614 (Haughton)
- 100-16200 (CALREP)
- 100-13847 (SMC)

Index: Forrest Rogers to 157-2305; Hugh Lance to 157-1813; ~~XXXXXXXXXX~~; Michael Brooks & Steve O'Neil to 100-13847. In 157-2832 - Ev Moore - 100-12461-629; 689

170-286A-136

Block Stamp

SEARCHED	INDEXED
SERIALIZED	FILED

S. Christensen

- 1 - Los Angeles
- 1 - 157- (Hugh Lance)
- 1 - Phoenix
- 1 - 157- (Ev Moore)

170-286

JEROME
12/9/71

The information regarding BILL CLAY's involvement in the Witches Coven on the University of California at San Diego campus originally came from SAM DAVIS and STAN MC DADE. He has been in the Witches Coven for over a year now and I believe he is still involved with it. Apparently, his main interest in this group is the sexual promiscuity of the women who are involved.

With regard to explosives, I have no personal knowledge of any caches buried in the desert or elsewhere on CLAY's part, although he did claim to have made such caches. I have seen him in possession of metal cans or boxes full of dynamite and other explosives which he claimed to have dug up from such a place. I have also known him to be in possession of other explosives and believe he still has the rented garage which I, at one time, observed to be chuck full of .30 caliber carbine ammunition. In addition, SAM DAVIS told me that at one time he saw at least \$500 worth of gold in CLAY's garage.

The current information on CLAY is that he is running around with FORREST (FROSTY) RODGERS. RODGERS is the full-time west coast leader of the JOHN BIRCH Society. I was told that CLAY and RODGERS do a lot of flying together.

BETTIE HAUGHTON is doing all of the printing for the SAO on her off set press which is now located at WALT GUIRE's house. She is also helping on organizational work for the SAO and has provided contact lists which may contain as many as 600 names of former contacts of TROY HAUGHTON. Most of these names, however, are probably just those appearing on mailing lists rather than actual contacts.

In addition, BETTIE HAUGHTON still makes frequent trips north to the place owned by HUGH LANCE near Big Pine, California.

With regard to the 1972 Republican National Convention, SAM DAVIS told me the other day that he is busy setting up an alibi for him to use during the convention. His plan is to give the impression of being out of town during the convention by driving his car to Arizona and pretending to stay there with EV MOORE. He will have MOORE cover for him as though he were in Phoenix when actually he will fly back to San Diego to commit various acts of harassment, etcetera, during the convention following which he will fly back to Phoenix and then drive home.

Two individuals named MICHAEL BROOKS and STEVEN O'NEIL have come to my attention. These persons are, or were, running the SMC Organization at Grossmont Junior College. However, BROOKS may now be attending school at San Diego State College. BROOKS and O'NEIL supposedly are still residing together. This information came from BROOKS' elder brother.

O'NEIL'S YOUNGER

Jerome

Date prepared

2/8/72

Date received

12/20/71

Received from (name or symbol number)

[Redacted]

Received by

SA Steven L. Christensen

Method of delivery (check appropriate blocks)

in person by telephone by mail orally recording device written by Informant

If orally furnished and reduced to writing by Agent:

Date

Dictated _____ to _____

Transcribed _____

Authenticated by Informant 2/2/72

Date of Report

12/20/71

Date(s) of activity

12/20/71

Brief description of activity or material

Info re George Hoover, Frank Yacopac, Robert Mayer, Sam Davis

File where original is located if not attached

* INDIVIDUALS DESIGNATED BY AN ASTERISK (*) ONLY ATTENDED A MEETING AND DID NOT ACTIVELY PARTICIPATE. VIOLENCE OR REVOLUTIONARY ACTIVITIES WERE NOT DISCUSSED.

Information recorded on a card index by _____ on date _____

Remarks:

- 157-3017 (Hoover)
- 170-286A-137
- 100-14819 (Godfrey)
- 157-1820 (Yacopac)
- 157-2931 (Mayer)
- 157-2815 (SAB)
- 157-3001 (Davis)
- 157-2933 (McDade)
- 157-1014 (Haughton)
- 157-28 (NSWPP)
- 100-15450 (Bohmer)
- 3- Los Angeles
 - 1-157 (Glenn Jackson)
 - 1-157 (John Zemanoc)
 - 1-157 (American Volunteer Group)
- Baltimore

Index: Jesse Clayburn Stevens to 157-2815 - also Robert DeFugis, Glenn Jackson, John Zemanoc, "American Volunteer Group", Alex Rapid Print.

Info re sample of metal alleged to be gold: sample shown to SA Roy Rymill, formerly a geologist. Stated sample is copper, not gold, & appears to be "native" copper.

100-14541 - American Block Shop (inv. 002)

170-286A-137 (1-26-72)

SEARCHED	INDEXED
SERIALIZED	FILED

FBI - SAN DIEGO

Mr. [Signature]

December 20, 1971
By Jerome

GEORGE HOOVER was at my house this morning and left with me a sample of the metal which he alleges is stolen government gold. He said he has come to the conclusion that the metal must be a gold-platinum alloy because of the high melting temperature it has.

BARRY GODFREY told me that FRANK YACOPEC and ROBERT MAYER went by the house at 3121 Beech Street in an attempt to get at the printing press located there to destroy it. Apparently, they were not able to accomplish anything there as I have not heard of anything happening.

YACOPEC is now gone to Los Angeles, California, on a trip following which he will travel to Gary, Indiana, to visit with his brother. He said he will try to do some recruiting for the SAO while there, and will put up SAO stickers and leaflets wherever he can.

Friday I was at SAM DAVIS' house where I observed a letter to DAVIS from JESSE CLAYBURN STEVENS at Silver Springs, Maryland. In the letter, STEVENS talked of how he and his group hated ROBERT DE PUGH and stated that he was in contact with GLENN JACKSON and JOHN ZEMANEC of the American Volunteer

Group at Los Angeles. STEVENS, who knows SAM DAVIS only by the name PATRICK MC DONALD, stated that he was anxious to get in touch with right-wing groups or individuals in the Southern California area. He advised he had received some SAO literature but said he corresponds with several individuals in the San Diego area and did not know who had furnished him with the SAO literature. (This was STAN MC DADE).

I also observed DAVIS' reply to STEVENS in which he stated that the SAO was also interested in making contact with STEVENS' group and other similar groups in the East. He said that the SAO remains Minuteman at heart and in principle regardless of the name or form it might take.

The SAO has had printed 200 copies of an information sheet on PETER BOHMER, which is to be distributed to right-wing activists and other individuals in the San Diego area. The printing was done by ALEX (LNU) at Alex Rapid Print House, and the only charge was \$3.50 for the materials. So far, SAO has spent \$140 on printing its literature, most of which has come out of the pockets of DAVIS and GODFREY. The stamps for this SAO mail-out alone will cost \$16.

ALEX of Alex Rapid Print is a former Minuteman who allowed TROY HAUGHTON to do all of the West Coast Minuteman print work on his equipment. He has now agreed to do all of the SAO printing work at cost.

While I was at work the other day, a colored individual came in to report a leak in a water main. He was driving an old pickup truck with California license M30319 and was wearing a chrome-plated Nazi helmet with an American flag painted on it. I don't know what significance this might have.

With regard to the Nazis, I have learned that their new headquarters is located at 7720 University in La Mesa and is called the White Power Information Center.

I also understand that the SAO may attempt to run a poster campaign on Camp Pendleton as there are suppose to be a lot of good recruit possibilities there.

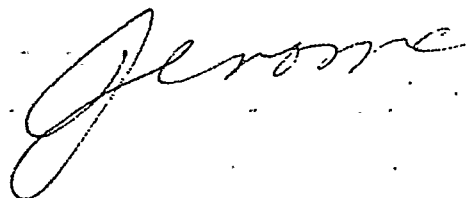
A handwritten signature in cursive script, appearing to read "Jensen".

Date _____

TO: CHIEF CLERK

Subject J. Lee Jackson

Aliases _____

Address _____ Birth Date _____ Birthplace _____ Race _____ Sex
 Male
 Female

- | | | |
|--|---|--|
| <input type="checkbox"/> Exact Spelling | <input type="checkbox"/> Main Criminal Case Files Only | <input type="checkbox"/> Restrict to Locality of _____ |
| <input type="checkbox"/> All References | <input type="checkbox"/> Criminal References Only | |
| <input type="checkbox"/> Main Subversive Case Files Only | <input type="checkbox"/> Main Subversive (If no Main, list all Subversive References) | |
| <input type="checkbox"/> Subversive References Only | <input type="checkbox"/> Main Criminal (If no Main, list all Criminal References) | |

File & Serial Number	Remarks	File & Serial Number	Remarks
100-13932-15	?		
100-14541-19	?		

Requested by _____	Squad _____	Extension _____	File No. _____
Searched by _____			
Consolidated by _____			
Reviewed by _____			

File Review Symbols

I - Identical ? - Not identifiable
 NI - Not identical U - Unavailable reference GPO 875-388
 NW 55009 DocId:32989524 Page 583

Date prepared

2/15/72

Date received

12/28/71

Received from (name or symbol number)

*

Received by

SA Steven L. Christensen

Method of delivery (check appropriate blocks)

in person by telephone by mail orally recording device written by Informant

If orally furnished and reduced to writing by Agent:

Date

Dictated _____ to _____

Transcribed _____

Authenticated by Informant _____

Date of Report

12/28/71

Date(s) of activity

12/27/71

Brief description of activity or material

Info re Sam Davis, Bettie Haughton
Ron Zarick.

File where original is located if not attached

* INDIVIDUALS DESIGNATED BY AN ASTERISK (*) ONLY ATTENDED A MEETING AND DID NOT ACTIVELY PARTICIPATE. VIOLENCE OR REVOLUTIONARY ACTIVITIES WERE NOT DISCUSSED.

Information recorded on a card index by _____ on date _____

Remarks:

157-3001 (Davis) Index: Ed Carville to 157-
170-286A-138 2815
157-1813 (Haughton)
157-2921 (Zarick)
157-2815 (SAO)

1- Los Angeles
1-157- (Hugh Lance)

Block Stamp

170-286A-138

SEARCHED INDEXED
SERIALIZED FILED

FBI - SAN DIEGO

Jan 11 1972

Christensen ml

12/28/71

BY JEROME

I was in contact with SAM DAVIS yesterday. He told me that BETTIE HAUGHTON told him she has decided to remarry soon, probably about June, 1972. DAVIS did not tell me the name of the person she is to marry but identified him as the new owner of the Lodge at Big Pine or Lone Pine, California, which formerly belonged to HUGH LANCE. DAVIS said that apparently LANCE is now a Deputy Sheriff in Inyo County.

RON ZARICK told me yesterday that he has been fired from the last job he had.

I do not know the person named ED CARVILLE who received one of the SAO bulletins one PETER GEORGE BOHMER. Apparently he was just on the membership list which the SAO got from BETTIE.

Date prepared

2/15/72

Date received

12/29/71

Received from (name or symbol number)

X

Received by

SA Steven L. Christensen

Method of delivery (check appropriate blocks)

in person by telephone by mail orally recording device written by Informant

If orally furnished and reduced to writing by Agent:
Date

Dictated _____ to _____

Transcribed _____

Authenticated by Informant _____

Date of Report

12/29/71

Date(s) of activity

12/28/71

Brief description of activity or material

Info re Kyle Manning at Utah; Right Wing activities in San Diego area

File where original is located if not attached

* INDIVIDUALS DESIGNATED BY AN ASTERISK (*) ONLY ATTENDED A MEETING AND DID NOT ACTIVELY PARTICIPATE. VIOLENCE OR REVOLUTIONARY ACTIVITIES WERE NOT DISCUSSED.

Information recorded on a card index by _____ on date _____ 15400-9

Remarks:

- 100-14299 (Manning)
- 170-286A-139
- 157-2177 (Forrest)
- 100-14819 (Godfrey)
- 157-2815 (SAO)
- 157-3001 (Davis)
- 157-1816 (Poto)
- 157-1614 (Haughton)
- 157-3006 (Guire)
- 157-3007 (Guire)

Index: "Doc" Roberts to 100-14299.
Jesse Clayburn Stevens to 157-2815.

170-286A-139
Block Stamp

2- Salt Lake City

1- 157- (Kyle Jack Manning)

1- 157- ("Doc" Roberts)

1- Baltimore

1- 157- (Jesse Clayburn Stevens)

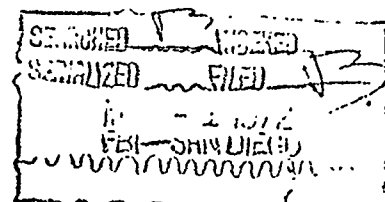

Christensen ml

12/29/71

BY JEROME

I received a telephone call last night from LYLE MANNING at Richfield, Utah. He has telephone number 801-896-5262, and gave me his address as Post Office Box 412, Richfield, Utah. He told me he is now employed taking care of the fair grounds and race track at Richfield. MANNING claimed that he and "DOC" ROBERTS are trying to form a right-wing activist group at Richfield and asked me to send him all the Minuteman literature that I could get for him. He also indicated that he and ROBERTS will be visiting the San Diego area about the middle of January, 1972. He said the purpose of their trip will be to obtain all the .30-06 and .308 caliber ammunition that they can find. He asked me to start looking around for this ammunition for him.

I visited TOM FORREST's place last night and learned that somehow he is obtaining a large number of the top halves for M-16 rifle receivers. Apparently the only real difference between the M-15 rifle, which is semi-automatic, and the M-16 rifle, which is fully automatic, lies in the top half of the receivers. He claims to have no trouble selling all these items that he can get ahold of and he must have a good source for such weapon parts.

BARRY GODFREY told me that SAM DAVES has received more correspondence from JESSE CLAYBURN STEVENS from Silver Springs, Maryland. In his letters STEVENS agreed to the formation of an alliance between the SAO and his group. According to the guidelines which were set up, STEVENS' group will have control over right-wing activities in the east and in the south while the SAO will control all activities in the western and northern states. Both groups will work at trying to find and establishing a coordinate at or near Chicago, Illinois, to handle all activities in the mid-west area. GODFREY said that a good possibility for this job would be JIM POTO. He pointed out that POTO works for a national restaurant chain, possibly Howard Johnson in San Diego, as a restaurant manager. POTO has indicated that he expects to be transferred in the near future to the Chicago area to open a new restaurant and if so, he would make an ideal coordinator for the mid-west group.

In addition, arrangements were made in the letters from STEVENS to trade information between the two groups on people of interests to them who reside in each others areas. In other words, if the SAO has information on a prospective right-wing contact or other such person residing in the area controlled by STEVENS' group, this information would be sent to this group and vice versa.

Furthermore an agreement was made to transfer members of the SAO and STEVENS' group who move from one area to another.

STEVENS advised that his group has micro-filming equipment in it's possession. GODFREY claimed that the SAO will also obtain such equipment as soon as it possibly can and in the future, all "secure" messages between the two groups will be transmitted by micro-film.

In addition, STEVENS claimed that his group is very much opposed to ROBERT BOLIVAR DE PUGH and claimed to have information pertaining to TROY HAUGHTON's death, indicating he may know someone who was involved in his murder. He indicated that he would communicate with the SAO on this matter later on. GODFREY said in his letters, STEVENS indicated he is very anti-police, FBI and informers. He said if he could he would kill them all, drop them in a hole in the desert and pore lye on them. STEVENS offered to travel to San Diego to visit with leaders of the SAO and arrangements have been made.

GODFREY said that DAVIS has been working hard on the next bulletin of the SAO and now has it ready to go to the printers. This bulletin will be ten pages long and will consist of eight pages of technical information pertaining to explosives, booby traps, and other similar items. The other two pages will contain general information relating to news, recruiting, training, etc.

GADFREY also said that WALT and EDITH GUIRE have now agreed to do research for the SAO on subjects of interest to the organization. The GUIRES reside at 4114 Massachusetts, La Mesa, California, where they have telephone number 463-4648.

Date prepared

2/18/72

Date received

1/6/72

Received from (name or symbol number)

InFormant

Received by

SA Steven L. Christensen

Method of delivery (check appropriate blocks)

in person

by telephone

by mail

orally

recording device

written by Informant

If orally furnished and reduced to writing by Agent:

Date

Dictated _____ to _____

Transcribed _____

Authenticated by Informant _____

Date of Report

1/6/72

Date(s) of activity

1/4/72

Brief description of activity or material

Info re Gerald L. Smith and
NSWPP

File where original is located if not attached

* INDIVIDUALS DESIGNATED BY AN ASTERISK (*) ONLY ATTENDED A MEETING AND DID NOT ACTIVELY PARTICIPATE. VIOLENCE OR REVOLUTIONARY ACTIVITIES WERE NOT DISCUSSED.

Information recorded on a card index by _____ on date _____

Remarks:

157-201 (Smith)

170-286A-140

157-28 (NSWPP)

157-2931 (Mayer)

- Los Angeles

1- 157-6836 (NSAWP)

1- 157- (NSWPP)

1- 157- (Scott Winchester)

1- 157- (Joseph Tomasi)

Index: Chuck Sperry
157-2931 - also Chuck Pearce
No discrimination required on
Chuck Pearce as he is on
a gun collector and not
involved in any extremist
activities.

Block Stamp

170-286A-140

SEARCHED INDEXED
SERIALIZED FILED

FBI - SAN DIEGO
JAN 21 1972

1/6/72

BY JEROME

ADDITIONAL INFORMATION RECALLED FROM MY VISIT
WITH GERALD SMITH OF THE NSWPP.

He always goes armed to the NSWPP meetings as do all members of the group. I suspect that these people are generally armed at all times. However SMITH indicated to me that he and the NSWPP do not believe in violent armed revolutions at this time.

He explained this position by stating that he believes that there really are no such things as political questions or issues. He said he believes the basis for all such political questions and issues actually lies in racial concerns. He said because of this he feels that eventually the people in the United States will become fed up with racially oriented oppressions and will vote the NSWPP into power at the polls, hence no need for a revolution.

SMITH has a weird appearance and is not physically tough looking as you might expect a Nazi to be.

BOB MAYER is now living at 2204 Mt. Clair Street, San Diego, California and has telephone number

284-3697. The house at this address was purchased by him from CHUCK SPERRY, ^Athe local leader of the John Birch Society. As you will remember MAYER is supposed to marry SPERRY's daughter soon. MAYER, who was formerly a Marine, spent some time in Vietnam and claims to have been wounded there.

The other person referred to is CHUCK PEARCE. He is a member of the Army's Special Forces Unit in San Diego.

With regard to the two Nazi factions at Los Angeles I have heard that JOE TOMASI claims that SCOTT WINCHESTER's group is defunct, however WINCHESTER claims his group is still going and is the most active.

Jerome

Date prepared

2/2/72

Date received

11/5/71

Received from (name or symbol number)

[Redacted] Informant

Received by

SA Steven L. Christensen

Method of delivery (check appropriate blocks)

in person by telephone by mail orally recording device written by Informant

If orally furnished and reduced to writing by Agent:

Date

Dictated _____ to _____

Transcribed _____

Authenticated by Informant 2/2/72

Date of Report

11/5/71

Date(s) of activity

11/5/71

Brief description of activity or material

Contact with Sam Davis; info re Scott Winchester; Contact with Stan McDade

File where original is located if not attached

* INDIVIDUALS DESIGNATED BY AN ASTERISK (*) ONLY ATTENDED A MEETING AND DID NOT ACTIVELY PARTICIPATE. VIOLENCE OR REVOLUTIONARY ACTIVITIES WERE NOT DISCUSSED.

Information recorded on a card index by _____ on date _____

Remarks:

157-3001 (Davis)

~~170-286A-141~~

157-28 (NSWPP)

157-2933 (McDade)

157-1798 (MM)

100-14427 (MIC)

157-2815 (SAO)

2 - Los Angeles

1 - 157-8836 (NSAWP)

1 - 157- (Scott Winchester)

1 - 157-2898 (Scott Winchester) 170-286A-141

Index: ~~_____~~ to 157-28; "On Target" to 157-1798.

Block Stamp

SEARCHED	INDEXED
SERIALIZED	FILED
FEB 2 1972	
FBI - SAN DIEGO	

[Handwritten signature]

JEROME
November 5, 1971

I was talking with SAM DAVIS this morning and he told me that SCOTT WINCHESTER's Nazi Group at Los Angeles has folded up. He said WINCHESTER apparently did not think his group was doing anything worthwhile. I am supposed to meet with DAVIS tomorrow to discuss our strategy with regard to WINCHESTER and his group. DAVIS wants me to go with him to Los Angeles next Saturday to talk with WINCHESTER as it appears that WINCHESTER and the supporters he has left may now be ready to join the SAO.

I was also by the old address of the Message Information Center earlier today. It looks to me as though the Message Information Center may have moved as the building where it used to be is now being remodeled into a very plush office space.

I was also talking to STAN MC DADE who told me he had received in the mail a brand new issue of "On Target" which came from Maryland and which claimed to be the place of the Minuteman Organization. I will attempt to obtain the publication from him. He said he has no idea as to how the publishers of the paper might have obtained his name and address, although he said he did write to a gun parts shop in Maryland approximately one week before he received the paper.

J Jerome

Date prepared

2/8/72

Date received

12/15/71

Received from (name or symbol number)

Informant

Received by

SA Steven L. Christensen

Method of delivery (check appropriate blocks)

in person by telephone by mail orally recording device written by Informant

If orally furnished and reduced to writing by Agent:

Date

Dictated _____ to _____

Transcribed _____

Authenticated by Informant 2/2/72

Date of Report

12/15/71

Date(s) of activity

12/15/71

Brief description of activity or material

Info re Jerry Lee Busch, George Hoover, Peter Bohmer, Ron Zarick, Barry Godfrey

File where original is located if not attached

* INDIVIDUALS DESIGNATED BY AN ASTERISK (*) ONLY ATTENDED A MEETING AND DID NOT ACTIVELY PARTICIPATE IN VIOLENCE OR REVOLUTIONARY ACTIVITIES WERE NOT DISCUSSED.

Information recorded on a card index by _____ on date _____

Remarks:

100-15355 (Busch)

170-286A-142

170-26 sub-1

100-15450 (Bohmer)

157-2815 (SAO)

157-2921 (Zarick)

157-3017 (Hoover)

100-14939 (Busch)

100-14819 (Godfrey)

100-15971 (Box)

Index: Scottie Schultz to 15

2921 - ~~to~~ Bud Kitchens

1-92-974

Info re Ron Zarick & Scottie Schultz furnished to SI Larry Clendinen, ATF O on 12/17/71.

Block Stamp

170-286A-142

SEARCHED INDEXED

SERIALIZED FILED

FBI - SAN DIEGO

CHRISTENSEN

December 15, 1971
By Jerome

It has come to my attention that JERRY LEE BUSCH, GEORGE HOOVER, and one or two of their friends have been present at the protest demonstrations sponsored by the supporters of PETER BOHMER. Apparently, they were taking photographs and gathering other information for the use of SAO. The SAO, by the way, wants to put out a counter-intelligence type bulletin on BOHMER for the purpose of informing right wing activists in this area as to what is going on with regard to BOHMER, and also to create a stir and cause some concern for their safety among the left wing activists.

It has come to my attention by way of RON ZARICK, who I talked to yesterday, that there is an individual named SCOTTIE SCHULTZ in the area. SCHULTZ is known to be an informer for ATFD and is believed to have been responsible for setting up the arrest and conviction of BUD KITCHENS. He has been gone from the San Diego area for a considerable period of time but is back nosing around again. ZARICK said there seems to be particular interest in JOHN BUSH on the part of ATFD and ZARICK feels BUSH may be the next one to be arrested.

I have learned from BARRY GODFREY that he and GEORGE HOOVER went by The Box commune at 5155 Muir last night. No particular activity was observed; however, the following vehicles and license plate numbers were observed:

Yellow Ford Van with California license CHG 687;

Light blue Plymouth Valiant two-door with California license HMJ 385;

Green Dodge Dart two-door with California License RGH 420;

White Chevrolet Corvair (parked in driveway next to house - license number not seen);

The telephone number for the telephone at The Box is 222-7243.

Jerome

Date prepared

2/8/72

Date received

12/13/71

Received from (name or symbol number)

Informant

Received by

SA Steven L. Christensen

Method of delivery (check appropriate blocks)

in person

by telephone

by mail

orally

recording device

written by Informant

If orally furnished and reduced to writing by Agent:

Date

Dictated

to

Transcribed

Authenticated by Informant

2/2/72

Date of Report

12/13/71

Date(s) of activity

Current

Brief description of activity or material

Info re Tom Forrest, Sam Davis, Stan McDade, Barry Godfrey

File where original is located if not attached

* INDIVIDUALS DESIGNATED BY AN ASTERISK (*) ONLY ATTENDED A MEETING AND DID NOT ACTIVELY PARTICIPATE. VIOLENCE OR REVOLUTIONARY ACTIVITIES WERE NOT DISCUSSED.

Information recorded on a card index by

on date

Remarks:

157-2177 (Forrest)
170-286A-143
170-26 sub
157-3001 (Davis)
157-2933 (McDade)
100-14819 (Godfrey)

Index: FNU Larkin to 157-2177
Bill Guette + Chuck Pearce to 100-14819; "Minuteman Army" to 157-3001.

Information re Forrest and Larkin furnished to SI Larr Clendinen, ATFD, 12/17/71.

Block Stamp

170-286A-143

SEARCHED	INDEXED
SERIALIZED	FILED

FBI - SAN DIEGO

[Signature]

December 13, 1971
By Jerome

I had a conversation with TOM FORREST yesterday. He said he had received information that there is a ATFD informant working in this area again and he wanted to make sure that everyone was alerted. He said this individual is named (FNU) LARKIN, is about 50 years old, 5'8" tall, 150 pounds, with short red hair and a red complexion. Apparently ATFD has attempted to use this individual in the San Diego area on previous occasions. I was told that LARKIN was trying to sell 40 machine guns to SAM DAVIS.

SAM DAVIS and STAN MC DADE are attempting to raise enough money to open a gun shop in this area which will be called the "Minuteman Armory".

Along the same line, BILL GUIETTE of Bullseye Gun Shop; CHUCK PEARCE of the John Birch Society; and BARRY GODFREY of the SAO, are to get together and set up an ammunition dump somewhere in the desert.

They have also discovered that receivers for light .30 caliber machine guns can be easily manufactured with a regular milling machine from flat pieces of steel which are then welded together. The "Minuteman Armory" may involve itself in manufacturing some of these receivers.

Jerome

Date prepared

2/8/71

Date received

12/17/71

Received from (name or symbol number)

[Redacted] Informant

Received by

SA Steven L. Christensen

Method of delivery (check appropriate blocks)

in person by telephone by mail orally recording device written by Informant

If orally furnished and reduced to writing by Agent:

Date

Dictated _____ to _____

Transcribed _____

Authenticated by Informant 2/2/71

Date of Report

12/17/71

Date(s) of activity

Current

Brief description of activity or material

Info re Right Wing activities in San Diego area.

File where original is located if not attached

* INDIVIDUALS DESIGNATED BY AN ASTERISK (*) ONLY ATTENDED A MEETING AND DID NOT ACTIVELY PARTICIPATE IN VIOLENCE OR REVOLUTIONARY ACTIVITIES WERE NOT DISCUSSED.

Information recorded on a card index by _____ on date _____

Remarks:

- 157-3017 (Hoover)
- 170-286A-144
- 100-14301 (Ruplinger)
- 157-2832 (Carey)
- 100-14807 (Jerry Geier)
- 100-14819 (Godfrey)
- 170-26 sub.
- 157-2933 (McDade)
- 157-2439 (Weatherby)
- 157-201 (Smith)
- 157-28 (NSWPP)
- 157-3017 (Hoover)
- 157-2815 (SAO)
- 157-14242 (Joseph Brinkley)
- 157-14243 (Walt)

Info. re theft of ROTC weapons from armory at Sweetwater High School discussed with Detective Steven Scarpiti, National City PD, 12/28/71. He advised he could find no information relating to alleged incident but would contact FBI later if anything was learned.

100-14192-105-525

Block Stamp

170-286A-144

SEARCHED INDEXED SERIALIZED FILED

FBI - SAN DIEGO

1971

December 17, 1971
By Jerome

I was in contact with GEORGE HOOVER yesterday. He claimed that he, in turn, is in contact with some individuals, whose identities he did not even hint at, who claim to have possession of a large quantity of stolen U.S. government gold.

According to HOOVER, this gold is in a 55 gallon drum and must weigh close to 1,000 pounds. He said the gold, of which he has a sample, is in small pieces which have the appearance of having been melted. HOOVER said he has been asked by these other individuals to help sell the gold. He said the idea is to package it in ten or twenty pound lots but did not know what the asking price would be. He said he would furnish me a sample of this material tomorrow, which I could take to PAUL RUPLINGER or some other place and have analyzed. He said the people selling the gold will want as much for it as they can get.

HOOVER, himself, continues to reside in housing furnished for him at the Wood King Wood Yards on Magnolia near Santee. He is currently employed making deliveries of

wood for the Wood Yards, receiving \$5 per delivery. He claims to be making six to eight deliveries a day.

With regard to DON CAREY, it has come to my attention that he has recently been spreading rumors designed to place JERRY GEIER, BARRY GODFREY, and others in a bad light with other right-wing activists. However, most people who know CAREY do not pay much attention to him as it is generally held that he is "nuts" and is really flipping out. I do not think CAREY is currently employed. He is described as follows:

Race	White
Age	Approximately 40 (looks younger)
Sex	Male
Height	5'7" - 5'8"
Weight	150 pounds
Build	Wiry
Hair	Very dark colored

He resides with his mother, JEANETTE WORDELL, at 4069 El Cajon Boulevard, where he has telephone number 284-7807. He also claims to have a place at Campo for use as a hide-out if necessary. To the best of my recollection, he drives a gray Jeep-type Toyota vehicle.

Last night I was at JERRY GEIER's house. The conversation got around to the theft, some time ago, of weapons from the ROTC Armory at Sweetwater High School. GEIER said that the evening before the theft, he received a telephone call

from a friend (unnamed) who asked him if he wanted some BAR's and other similar weapons, to which GEIER replied that he did. His friend said he had a line on a supply of such weapons and that they would be available the following night. GEIER said that on the next night he and his friend went to a pre-arranged location, picked the weapons up and brought them back to GEIER's residence where they were stored in the garage. According to GEIER, the following morning when he went to work, a fellow employee jokingly asked him if he had purchased any machine guns. GEIER said "What do you mean?", whereupon the other individual pointed out to him an article in the paper regarding the theft of weapons from the Sweetwater High School ROTC Armory. GEIER said he checked the list of weapons reported to have been stolen against those he had purchased the previous evening and found it to match exactly. He said he immediately dashed home, wiped all the weapons down for fingerprints, and returned them to the source from which they had been obtained. However, neither he nor his friend received any money back that they had already paid for the weapons.

GEIER said that the source of the weapons was the son of the Army Sergeant regularly assigned to the ROTC Unit at Sweetwater High School. He said this individual apparently backed

a truck into the wall of the room containing the ROTC weapons, breaking a large hole through the which the weapons were loaded into the truck. GEIER said that after the weapons were returned to the Army Sergeant's son, he took them to the Singing Hills Golf Course where they were later found laying on the grass.

Word has come to me from STAN MC DADE that WILLIAM WEATHERBY has either quit or been dropped from the NSWPP. He may be the Lieutenant of GERALD L. SMITH who quit when ordered by SMITH to leave his Mexican wife. I understand that GEORGE HOOVER is working to recruit WEATHERBY for the SAO.

It has also come to my attention that the NSWPP has opened a formal headquarters and office space either on University or El Cajon Boulevard in La Mesa. The rent for this space is \$125 per month, and I believe is being financed primarily by VIC WALTON and/or JOE BRINKER.

I have also heard that BARRY GODFREY will be working with STAN MC DADE and GEORGE HOOVER to compile a list of the local NSWPP members. I don't know how many members may be left following the recent shake-up in that organization.

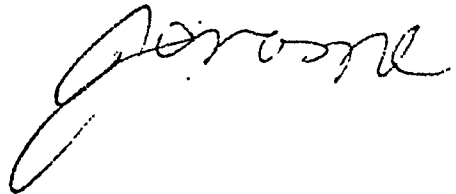
A handwritten signature in cursive script, appearing to read "George Hoover", is written in the lower right portion of the page.

Date prepared

2/18/72

Date received

1/5/72

Received from (name or symbol number)

Informant

Received by

SA Steven L. Christense

Method of delivery (check appropriate blocks)

in person

by telephone

by mail

orally

recording device

written by Informant

If orally furnished and reduced to writing by Agent:

Date

Dictated

to

Transcribed

Authenticated by Informant

Date of Report

1/5/72

Date(s) of activity

1/4/72

Brief description of activity or material

Info re NSWPP activities

File where original is located if not attached

* INDIVIDUALS DESIGNATED BY AN ASTERISK (*) ONLY ATTENDED A MEETING AND DID NOT ACTIVELY PARTICIPATE. VIOLENCE OR REVOLUTIONARY ACTIVITIES WERE NOT DISCUSSED.

Information recorded on a card index by _____ on date _____

Remarks:

157-28 (NSWPP)

(170) 286A-145

157-1798 (MM)

157-201 (Smith)

100-14303 (Victor Watson)

100-16200 (CALREP)

157-2545 (Wilson)

157-3017 (Hoover)

157-2933 (McDade)

157-2920 (Cropsey)

157-3001 (Davis)

157-2815 (SAO)

100-14303 } actual
105-2037 } cards

J

170-286A-145

Block Stamp

SEARCHED	INDEXED
SERIALIZED	FILED
FBI - OHIO FIELD	
[Handwritten signatures and initials]	

1/5/72

BY JEROME

Last night I went to the NSWPP White Power Information Center located at 7720 University, La Mesa, California and spoke with GERALD SMITH, using an assumed name. This is the first time that I have talked with SMITH and I found him to be very egotistical, highly talkative and very much down on the Minuteman organization and related right-wing activities. He claimed to know all of the Minuteman leaders and indicated that he and his group went on maneuvers with the Minuteman organization all the time. He stated that he thinks the Minuteman organization is comprised of a bunch of cowards who will not do anything to protect the country when the time comes. He impressed me as being really "nuts".

SMITH mentioned VIC WALTON as one of the backers of the NSWPP and hinted that most of the financing for his group comes from out-of-state. He said that his plans for the 1972 Republican National Convention will include picketing of both the Republican and Left Wing groups.

According to SMITH, the NSWPP holds a meeting each Wednesday night at 7:30 PM which is open to the public.

This White Power Information Center is open on Tuesday, Thursday and Friday evenings from 6:00 to 8:30 PM and on Saturday afternoons.

He said the NSWPP rented the space for the White Power Information Center under the ruse that it was to be used for a book store, otherwise the group either would already have been evicted or never would have been rented the space in the first place.

While he was there, there was another strange looking young male individual with SMITH who he believed was named RAY WILLIAMS or WILSON. He was described as follows:

Race	White
Height	5'6"
Weight	130-135 pounds
Hair	Blond
Complexion	Pale
Build	Slender
Eyes	Blue
Dress	Wearing skin-tight pants and an Eisenhower jacket with a swastika on the collar.

I have heard that GEORGE HOOVER is attempting to wean this person away from SMITH.

In addition, from their conversation it appears that the NSWPP is down on STAN MC DADE.

I do not know of the individual named STEVEN LINN CROPSEY or anything about his involvement in the NSWPP.

I was in contact with SAM DAVIS who is in the process of making up a master file on right-wing activities. Hopefully I will have access to this information.

DAVIS also advised that the new ten page SAO bulletin has been printed and should be out tomorrow. He stated that he is anxious to start preparing another special intelligence bulletin to be put out by the SAO. This time he wants the target of the bulletin to be some nationally known figure in the new left, such as JERRY RUBEN, WILLIAM RUNSTLER or ABBIE HOFFMAN.

Gerone

Date prepared

3/14/72

Date received

1/7/72

Received from (name or symbol number)

Informant

Received by

SA STEVEN L. CHRISTENSEN

Method of delivery (check appropriate blocks)

in person

by telephone

by mail

orally

recording device

written by Informant

If orally furnished and reduced to writing by Agent:

Date

3/14/72

to

Ronnie Wilson

Transcribed _____

Authenticated
by Informant _____

Date of Report

1/7/72

Date(s) of activity

1/6/72 - 1/7/72

Brief description of activity or material

INFORMATION REGARDING S.A.O.

File where original is located if not attached

* INDIVIDUALS DESIGNATED BY AN ASTERISK (*) ONLY ATTENDED A MEETING AND DID NOT ACTIVELY PARTICIPATE. VIOLENCE OR REVOLUTIONARY ACTIVITIES WERE NOT DISCUSSED.

Information recorded on a card index by _____ on date _____

Remarks:

1-157-2815 (SAO)

cc:

1-170-286A-146

1-157-30001 (DAVIS)

1-157-2931 (MAYER)

1-100-14819 (GODFREY)

1-100-15450 (BOHMER)

g

170-286A-146

Block Stamp

SEARCHED _____
SERIALIZED _____ FILED _____
APR 1 1972
FBI - SEATTLE
Christensen M
1-157-2815-146

1-SEATTLE DIVISION (CY ANDERSON)

January 7, 1972
By JEROME

I learned last night from BOB MAYER that he, SAM DAVIS, and BARRY GODFREY were at San Diego State College (SDSC) yesterday putting up SAO stickers, particularly around the office of Professor PETER BOHMER.

I understand that in the evening some harassing telephone calls were made by SAO members to the residence of Professor BOHMER.

SAM DAVIS brought to my attention the fact that CY ANDERSON is suppose to be in town from Seattle, Washington, next week. DAVIS said that ANDERSON is going to bring a large quantity of stuff to sell, including the following:

Military mountain style mummy sleeping bags at three for fifty dollars

New military field jackets with hoods at eleven dollars each and without hoods, nine dollars each

Parachute rifle grenades at two dollars a piece or six for ten dollars.

Military brass and steel cleaning rods

Two new AR-180's at \$210.00 each.

One used AR-14 at \$225.00.

One used high stand .22 caliber pistol at seventy dollars.

One used Colt Diamond Back .38 caliber pistol at \$90.00.

Jerome

One used M-1 carbine at seventy dollars.

One used M-2 carbine at one hundred thirty five dollars.

One used 1903 Springfield at sixty five dollars.

One used Model 97 Winchester Riot Gun at eighty five dollars.

DAVIS claims he has also contacted some acquaintances of his in Kansas and Oklahoma regarding establishing the SAO in those area. He further claimed to have recruited two unidentified individuals at Carson near Los Angeles, California, into the SAO. He also advised he has received letters of inquiry regarding the SAO from the Redding, California, area, and from some where in the State of Maryland.

Jerome

Date prepared

3/14/72

Date received

1/12/72

Received from (name or symbol number)

Informant

Received by

SA STEVEN L. CHRISTENSEN

Method of delivery (check appropriate blocks)

in person by telephone by mail orally recording device written by Informant

If orally furnished and reduced to writing by Agent:

Date

Date of Report

Dictated 3/14/72 to RONNIE WILSON

1/12/72

Transcribed _____

Date(s) of activity

Authenticated by Informant _____

1/11/72

Brief description of activity or material

INFORMATION REGARDING SAO AND RIGHT WING
ACTIVISTS IN SAN DIEGO AREA

File where original is located if not attached

* INDIVIDUALS DESIGNATED BY AN ASTERISK (*) ONLY ATTENDED A MEETING AND DID NOT ACTIVELY PARTICIPATE. VIOLENCE OR REVOLUTIONARY ACTIVITIES WERE NOT DISCUSSED.

Information recorded on a card index by _____ on date _____

Remarks:

1-157-2815 (SAO)

cc:

- ① 1-170-236A-147
- 1-157-2931 (MAYER)
- 1-157-2933 (MC DADE)
- 1-157-3001 (DAVIS)
- 1-157-3017 (HOOVER)
- 1-157-1820 (YACOPEC)
- 1-100-14819 (GODFREY)
- 1-157-1813 (HAUGHTON)
- 1-100-15450 (BOHLER)

ACTION: With regard to information concerning TOM DRISCOLL of United States Customs, it is noted source advised DRISCOLL is known to have worked in the past with ATFD in setting up "shady" gun dealers and believed this was another similar attempt.

- 1-LOS ANGELES DIVISION (157-HUGH LANCE)
- 1-SEATTLE DIVISION (157-CY ANDERSON)

170-286A-147
Block Stamp

SEARCHED _____ INDEXED _____
SERIALIZED FILED _____
FBI - SAN DIEGO
CHRISTENSEN
1-170-286A-147

January 12, 1972
by JEROME

Yesterday BOB MAYER, STAN MC DADE, SAM DAVIS, NICK HOOVER, FRANK YACOPEC, "FAT JOHN" LENNOX (who has telephone number 284-1442) and LENNOX's shadow, a kid named DENNIS (LAST NAME UNKNOWN), were all at BARRY GODFREY's house discussing the shooting of a girl at Professor BOHMER's house and the implication that the SAO was responsible or at least involved. All those present were expecting to be interviewed regarding the shooting, and were bragging about what they were going to do when the police came to call. As usual, YACOPEC and MAYER were all excited about pulling off some big stunt.

DAVIS said he had been talking to BETTIE HAUGHTON, and according to her, the newspaper publicity which the SAO got in connection with the shooting incident, has stirred up a lot of interest among the Right Wing oriented individuals she knows. She told DAVIS she had received 25 to 30 contacts from people who formerly belonged to the Minutemen (MM) Organization who she said were interested in joining the SAO. She also told DAVIS she had showed some of the SAO literature to HUGH LANCE, who is suppose to be a Deputy Sheriff at either

Big Pine or Long Pine, California. She said he was very enthusiastic about the SAO and might join. DAVIS said we will have to make arrangements to contact him.

DAVIS mentioned he has another new SAO contact somewhere in the Los Angeles, California, area.

STAN MC DADE claimed to have received a telephone call from TOM DRISCOLL, a Customs Inspector at the Border at San Ysidro, California. DRISCOLL apparently asked MC DADE if he knew where DRISCOLL could purchase several machine guns. MC DADE said he once sold DRISCOLL a light point .30 caliber machine gun.

DAVIS said again that CY ANDERSON is suppose to be down in the San Diego, California, area, sometime in the near future. DAVIS said ANDERSON had been talking about going to the Mardi Gras in New Orleans and wants DAVIS to go with him. However, DAVIS probably will not be able to as he is currently on unemployment.

Jerome

Date prepared
3/14/72

Date received: 1/14/72
Received from (name or symbol number): Informant
Received by: SA STEVEN L. CHRISTENSEN

Method of delivery (check appropriate blocks)
 in person by telephone by mail orally recording device written by Informant

If orally furnished and reduced to writing by Agent:
Date: 3/14/72
Dictated to: RONNIE WILSON
Transcribed: _____
Authenticated by Informant: _____

Date of Report: 1/14/72

Date(s) of activity: 1/14/72

Brief description of activity or material:
INFORMATION REGARDING SAO

File where original is located if not attached

* INDIVIDUALS DESIGNATED BY AN ASTERISK (*) ONLY ATTENDED A MEETING AND DID NOT ACTIVELY PARTICIPATE IN VIOLENCE OR REVOLUTIONARY ACTIVITIES WERE NOT DISCUSSED.
 Information recorded on a card index by _____ on date _____

Remarks: 1-157-2815 (SAO) ACTION: INDEX GENE BOZARTH to 157-2815
cc: ①-170-286A-148
1-157-3001 (DAVIS)
1-157-2933 (MC DADE)
1-157-3017 (HGOVER)
1-157-1816 (POTO)
1-100-14319 (GODFREY)
1-157-1320 (YACOPEC)
1-157-2931 (MAYER)
1-100-14301 (RUPLINGER)
1-157-2769 (ED ANDREWS)
1-157-1813 (HAUGHTON)
1-157-2546 (CLARK)
1-157-3006 (GUIRE)
1-157-3007 (GUIRE)
2-157-NEW 3095 (AL RUPP)
1-157-28 (NSWPP)
1-157-1817 (WALT HAYWARD)
1-157-3005 (CONDE)

2-LOS ANGELES DIVISION
(1-157-SCOTT WINCHESTER)
(1-157-NATIONAL SOCIALIST AMERICAN WORKERS PARTY)

Block Stamp
SEARCHED INDEXED
SERIALIZED FILED
MAR 15 1972
FBI - LOS ANGELES
Christensen file
170-286A-148

January 14, 1972
by JEROME

The following are San Diego, California, area,
members of the SAO who are known to me:

JERRY LYNN DAVIS

STANLEY DON MC DADE

GEORGE M. HOOVER

JAMES EVAN POTO

HOWARD BARRY GODFREY

FRANK YACOPEC

ROBERT S. MAYER

PAUL RUPLINGER

In addition, I believe that one AL RUPP, a close
personal friend of DAVIS, may also be sort of a hip pocket
member of the SAO.

Specific members and supporters of the SAO include
HOWARD FRANCIS CLARK, who has been given a membership application
form which he has not returned yet, and ED ANDREWS, who has
been contributing finances to the SAO, but says he is not
ready to become a member yet. ANDREWS talks about returning
to the State of Arkansas, in the not too distant future, and
has indicated he might be agreeable to doing some recruiting
and organizing work there for the SAO.

BETTIE HAUGHTON has been doing some of the organizational and printing work for the SAO. She has an off-set press which is located in the garage of the house belonging to WALT and EDITH GUIRE located at 4114 Massachusetts, La Mesa, California. The GUIRES are former MM sympathizers, and are close friends of BETTIE HAUGHTON.

About December 29, 1971, the GUIRES agreed to do some research work for the SAO.

In addition, DAVIS said that WALT HAYWARD wrote to him recently about the SAO Offering to help in any way he can. However, he claimed he has been out of work for awhile and is short of money. Furthermore, SAM mentioned he would like to take BARRY GODFREY and pay a call to LOU CONDE to ask him for donations and other assistance for the SAO.

SAM said that SCOTT WINCHESTER, leader of the National Socialist American Workers Party, faction of the Nazi Group at Los Angeles, California, is to be in town tomorrow, January 15, 1972. Apparently the purpose of his visit will be to discuss the possibility of setting up some kind of a quasi alliance between the SAO and the NSAWP.

The name GENE BOZARTH has come to my attention as a likely source of good information regarding Left Wing activities on the San Diego State College (SDSC) campus.

BOZARTH, who is suppose to be a State College student, lives at 6979 Galewood, and has telephone number 583-8219, and a mailing address of Post Office Box 1566, San Diego, California.

When I was at DAVIS' house last night, talking about the visit of WINCHESTER to San Diego, California, AL RUPP was there, which kind of put the dampers on the discussion.

Jerome

Date prepared

3/14/72

Date received

1/17/72

Received from (name or symbol number)

Informant

Received by

SA STEVEN L. CHRISTENSEN

Method of delivery (check appropriate blocks)

in person by telephone by mail orally recording device written by Informant

If orally furnished and reduced to writing by Agent:

Date

3/14/72

RONNIE WILSON

Dictated

to

Date of Report

1/17/72

Date(s) of activity

1/16/72

Transcribed

Authenticated by Informant

Brief description of activity or material

INFORMATION REGARDING THE S.A.O.

File where original is located if not attached

* INDIVIDUALS DESIGNATED BY AN ASTERISK (*) ONLY ATTENDED A MEETING AND DID NOT ACTIVELY PARTICIPATE. VIOLENCE OR REVOLUTIONARY ACTIVITIES WERE NOT DISCUSSED.

Information recorded on a card index by _____ on date _____

Remarks:

1-157-2315 (SAO)

cc:

170-236A-149

1-100-14319 (GODFREY)

1-157-3001 (DAVIS)

Block Stamp

170-286A-149

SEARCHED _____ INDEXED _____

SERIALIZED _____ FILED _____

MAR 16 1972

FBI - SAN DIEGO

CHRISTENSEN

January 17, 1972
by JEROME

Last night BARRY GODFREY told that earlier in the day two San Diego, California, Police Department, detectives had come to his house questioning him about the shooting incident at the residence of Professor PETER BOHMER on January 6, 1972. GODFREY said the detectives names, SANDERS and SHIVELY, came on very strong as though GODFREY was a self-admitted member of the SAO. They asked what he knew about the shooting incident and whether the SAO had been involved. He told them he did not know anything about the shooting except when he had read the paper, and he did not elaborate on the SAO. They then asked him whether he had any 9 mm. weapons to which he replied he did not and that he did not like that caliber. Following that, they asked him if he knew anyone in the SAO who had anything to do with the incident and GODFREY said that he did not. The detectives then said the shooting incident was a very bad deal, and GODFREY agreed with them stating it was very unprofessional and that if someone had really wanted to do something to Professor BOHMER, they could have easily taken the front half of his building off.

GODFREY said the detectives were somewhat interested in his automobile, and explained to him that they had previously observed him visiting at the residence of JERRY LYNN DAVIS.

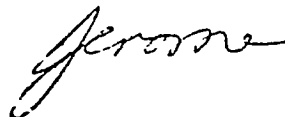

Date prepared

3/14/72

Date received

1/18/72

Received from (name or symbol number)

Informant

Received by

SA STEVEN L. CHRISTENSEN

Method of delivery (check appropriate blocks)

in person by telephone by mail orally recording device written by Informant

If orally furnished and reduced to writing by Agent:

Date

Dictated 3/14/72 to RONNIE WILSON

Transcribed _____

Authenticated by Informant _____

Date of Report

1/18/72

Date(s) of activity

1/17/72

Brief description of activity or material

INFORMATION REGARDING JERRY LYNN

DAVIS and S.A.O.

File where original is located if not attached

* INDIVIDUALS DESIGNATED BY AN ASTERISK (*) ONLY ATTENDED A MEETING AND DID NOT ACTIVELY PARTICIPATE. VIOLENCE OR REVOLUTIONARY ACTIVITIES WERE NOT DISCUSSED.

Information recorded on a card index by _____ on date _____

Remarks:

1-157-2815 (SAO)

cc:

① 170-286A-150

1-157-3001 (DAVIS)

1-100-14319 (GODFREY)

of

170-286A-150
Block Stamp

SEARCHED INDEXED
SERIALIZED FILED
MAR 15 1972
FBI - SAN DIEGO
[Handwritten signatures and initials]

January 18, 1972
by JEROME

Last evening BARRY GODFREY told me that SAM DAVIS had been interviewed by the same two detectives who talked to GODFREY the day before. He said they asked SAM if he was a member of the SAO and he said he was. They then asked him if he was responsible for the shooting incident at Professor BOHMER's house or if he knew of anyone who was involved in the incident to which DAVIS replied no. He then told the detectives that if the SAO, as an organization, had wanted to do something like that, Professor BOHMER would have been leveled to the ground. They then asked DAVIS many questions about the SAO to which he answered as truthful as he was able, and particularly they asked if the SAO intended to put out more bulletins similar to the one it had prepared on Professor BOHMER. DAVIS told them that the SAO did intend to print such bulletins, which caused the detectives to ask him if the same number of bulletins would be sent out or if more or less would be sent. DAVIS said more and indicated that the next bulletin would be sent to about three hundred people; the one after that to about five hundred people and the one after that to about one thousand people. According to DAVIS, this caused the detectives to become very upset and they said they did not think sending out so many bulletins was a very good idea as

this could cause a lot of trouble for somebody.

The detectives then asked DAVIS about the weapons which he owned and indicated they were aware that he has had about forty hand guns registered to him, including several 9 mm. weapons. DAVIS apparently told them he does not presently own any 9 mm. weapons, and satisfactorily explained to them the disposition of those which he once owned.

Jerome

170-286

Date prepared

3/14/72

Date received

1/20/72

Received from (name or symbol number)

Informant

Received by

SA STEVEN L. CHRISTENSEN

Method of delivery (check appropriate blocks)

in person by telephone by mail orally recording device written by Informant

If orally furnished and reduced to writing by Agent:

Date

Dictated 3/14/72 to RONNIE WILSON

Date of Report

1/20/72

Transcribed

Authenticated by Informant

Date(s) of activity

1/19/72

Brief description of activity or material

INFORMATION REGARDING RIGHT WING ACTIVISTS AND GUN DEALERS, SAN DIEGO, CALIFORNIA AREA.

File where original is located if not attached

* INDIVIDUALS DESIGNATED BY AN ASTERISK (*) ONLY ATTENDED A MEETING AND DID NOT ACTIVELY PARTICIPATE IN VIOLENCE OR REVOLUTIONARY ACTIVITIES WERE NOT DISCUSSED.

Information recorded on a card index by _____ on date _____

Remarks:

- 1-157- (BILL GUIETTE)
- cc: ① 170-286A-151
- 1-157-2177 (FORREST)
- 1-157-3001 (DAVIS)
- 1-157-2315 (SAO)
- 1-100-14219 (GODFREY)
- 1-157-3017 (HOOVER)
- 1-157-2332 (CAREY)
- 1-170-26 SUB

157-2177-11 } No main file
157-2815-31 }

ACTION:

Information regarding the possible possession of barrelled receivers for M-14 rifles by TOM FORREST has been discussed with SA ROBERT G. MOORE who indicated he was aware of FORREST's activities and would discuss them with ATFD.

INDEX JACK RICHARDS to SD 157-3001.
LARRY BROWN to SD 157 file on BILL GUIETTE.

With regard to information concerning DAVIS' plan to burglarize and blow up an explosives magazine, the San Diego Police Department was advised.

Block Stamp

170-286A-151

SEARCHED INDEXED SERIALIZED FILED

MAR 14 1972

FBI - SAN DIEGO

January 20, 1972
by JEROME

I have learned that the Bulls Eye Gun Shop in El Cajon, California, has been closed as it was not making much money. BILL GUIETTE, the former manager, is now hanging around with a friend named LARRY BROWN at the Jiffy Machine Shop. Most of the gun shop inventory, including many weapons, is now located in GUIETTE's garage at his home.

TOM FORREST has a business establishment named the Tom Forrest Company located in the Midway Industrial Center on Kurtz Street just off Rosecrans. He is usually there most afternoons and evenings.

I was at FORREST's place last night and learned that he had many bi-pods fro M-14 rifles, which were probably stolen. He said he got them from a Marine who had just walked in off the street with them. Furthermore, I was digging around in FORREST's back room, and found there in the neighborhood of one hundred boxes of what appeared to be barrelled M-14 actions. I opened one of the boxes sufficiently to see what was inside, and assumed that the rest of the boxes had the same thing in them. In my opinion, it is likely that these barrelled actions were suppose to have been destroyed at a place like Fort Ord, but somehow, got into FORREST's possession instead.

With regard to the shooting incident at Professor BOHMER's house, FORREST said he had been contacted by two detectives from the San Diego, California, Police Department. Apparently SAM DAVIS once had two 9 mm. pistols, and when he was interviewed by the detectives, he told them he sold one to TOM FORREST, and the other to an individual named JACK RICHARDS, a local "gun nut" type. FORREST said he guessed the detectives got in touch with him to check DAVIS' story out and verified that DAVIS did, in fact, sell him one of the two pistols. However, FORREST conveniently was unable to remember what he did with the gun after he bought it. He told me confidentially he had sold it to a Mexican in Tijuana, Baja California, Mexico.

FORREST said the detectives seemd to have been convinced that the weapons used in the BOHMER's shooting incident was a Browning High Power. They also asked FORREST if he was a member of the SAO which he denied. They then asked FORREST if he knew whether BARRY GODFREY owned or had purchased or sold any 9 mm. weapons, and what he usually bought from FORREST, when he did business with him. FORREST said he told them that GODFREY was not know to have any 9 mm. weapons and did not particularly like them, that he preferred .45 caliber pistols and .30 and that those were the only type he had purchased from FORREST. The detectives then asked FORREST whether SAM DAVIS ever came by and who with. FORREST told

him he had seen DAVIS in his shop, accompanied by CY ANDERSON and BARRY GODFREY. FORREST said he was impressed that the detectives were very excited about the SAO and he told them he had seen the SAO bulletin which was put out on BOHMER. The detectives then indicated they might contact GODFREY again and asked FORREST if he knew what shift GODFREY worked at the Fire Department.

I also saw GEORGE HOOVER yesterday. He is still up in the air about being interviewed by the Police Department over the BOHMER shooting. He said if the Police Department came to interview him, he would tell them exactly what he thought of them. (He does not think kindly of them). He said if the Federal Bureau of Investigation attempted to interview him, he would simply say that he believed the FBI to be an unconstitutional body and an agent of a foreign power and would refuse to be interviewed by the Federal Bureau of Investigation.

DAVIS claims he has obtained the keys to both the gate and the fence as well as the door to the explosives magazine of a sand and gravel company located on Mission Gorge Road. He said he also has a complete inventory of the contents of the magazine and said it appears there are enough explosives in the magazine to fill a semi-trailer truck. He said he has a plan, the basis of which is to go into the magazine at night with a truck, load up as much explosives as the truck will carry and then go out locking the door and gate behind but leaving a time delay charge behind to blow up the

magazine and its contents so no one would ever know how much, if any, of the explosives were taken.

It should be remembered that DON CAREY was suppose to have been a powder monkey at that location in the past, however, DAVIS said that JIM POTO was the one who actually came up with the keys. DAVIS did not explain how or where POTO got them.

J. Davis

UNITED STATES GOVERNMENT

Memorandum

TO : SAC, SAN DIEGO (157-2931)

FROM : SA STEVEN L. CHRISTENSEN

SUBJECT: ROBERT S. MAYER
EM - SAO

DATE: 3/31/72

Informant

On this date advised that the Subject had recently married the daughter of LEON C. SPERRY. SPERRY is prominent in the John Birch Society. In addition, MAYER purchased the residence at 2204 Montclair, San Diego, from SPERRY and is living there now with his wife.

Source said Subject formerly worked in a gas station in Mission Valley. He is now doing construction work through the local carpenter's union. Source said MAYER is believed to be driving a new Ford Falcon automobile.

It is noted that efforts to locate identifying information regarding the Subject through CLETS have been unproductive to date.

LEAD

Will review marriage records to obtain additional background information on MAYER.

Will determine nature of present employment.

Will determine vehicle he drives.

Will obtain photograph of Subject.

① 170-256A
1 - SD 157-2931
SLC/slc
(1)

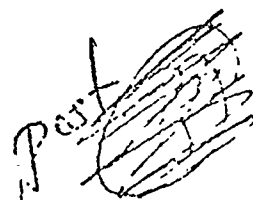
pls. Post 

170-256A-152

SEARCHED	INDEXED
SERIALIZED	FILED
MAR 31 1972	
FBI - SAN DIEGO	

[Handwritten signature]



Memorandum

TO : SAC, SAN DIEGO (88-4867)

DATE: 4/12/72

FROM : SA STEVEN L. CHRISTENSEN

SUBJECT: TAYLOR MORRIS TEAFORD, aka
UFAP - MURDER, ASSAULT TO COMMIT MURDER
TOP TEN FUGITIVE

Re Sacramento airtel to the Bureau on 2/22/72.

InFormant

On 3/15/72, [redacted] familiar with Minuteman and related activities in this area, was alerted to contents and requests of re: airtel. Source stated he would discretely check around and determine whether he could learn anything regarding TEAFORD.

On 4/4/72, source was recontacted at which time he advised that the Subject does not seem to be known in the San Diego area. He said he would remain alert to this matter and would immediately contact the writer if he should learn anything of value.

1 - SD 88-4867
① - SD 170-285 (Y)
S.L.C./slc
(2)

170-286-A-153

SEARCHED	INDEXED
SERIALIZED	FILED
APR 12 1972	
FBI - SAN DIEGO	

Buy U.S. Savings Bonds Regularly on the Payroll Savings Plan

5/16/72

CODE

TELETYPE URGENT

TO: BUREAU AND SAC LOS ANGELES ATTN: DID
FROM: SAC, SAN DIEGO (157-3170)

CALVIN HENDELL FOX; EM DASH SAO

A SOURCE WHO HAS FURNISHED RELIABLE INFORMATION IN THE PAST ADVISED ON MAY SIXTEENTH, NINETEEN SEVENTY TWO THAT, ONE OF THE MORE RABID AND VIOLENT/MEMBERS OF THE SECRET ARMY ORGANIZATION PAREN SAO END PAREN IN SAN DIEGO BOARDED A PLANE FOR WASHINGTON, D. C. THIS DATE MUTTERING THAT HE INTENDED TO DO SOME DEMONSTRATING HIMSELF. HE INDICATED TO ASSOCIATES THAT HE INTENDED TO RETURN IN TEN OR ELEVEN DAYS. FOX IS AN AVID SUPPORTER OF GOVERNOR GEORGE WALLACE, A PRESIDENTIAL CANDIDATE RECENTLY THE VICTIM OF AN ASSASINATION ATTEMPT.

FOX IS PRESENTLY ON PROBATION FOR THREE YEARS IN LOS ANGELES, CALIFORNIA FOR ATTEMPTING TO ATTACK A SPEAKER AT A RALLY AND FOR ATTEMPTING TO DESTROY EQUIPMENT BEING USED IN THE RALLY, ACCORDING TO SOURCE.

FOX OPERATES A GULF SERVICE STATION AT SECOND AND MOLLISON, EL CAJON, CALIFORNIA. HE IS DESCRIBED BY SOURCE AS FIVE FEET TEN OR ELEVEN INCHES TALL, SLENDER, ONE HUNDRED AND SIXTY POUNDS, DARK HAIR EXXEXX SLIGHTLY BALDING, AGE ABOUT FOARTY FIVE, DOES NOT WEAR GLASSES.

① - 170-286A
EMP:EMP

8

170-286A-154
[Signature]

CALIFORNIA LAW ENFORCEMENT TELETYPE SYSTEM PAREN CLETS END PAREN
RECORDS INDICATE FOX IS WHITE MALE, SIX FEET TALL, ONE HUNDRED SEVENTY
FIVE POUNDS, BLUE EYES, BROWN HAIR, RESIDENCE TWO FOUR TWO SIX
CAPITAN AVENUE, SAN DIEGO, CALIFORNIA, NINE TWO ONE ZERO FOUR.
CALIFORNIA DRIVER'S LICENSE NUMBER IS G SIX ONE ZERO FOUR EIGHT TWO.
HE FORMERLY RESIDED AT NINE TWO FIVE DIAMOND STREET, MONROVIA, CALIFORNIA.
ANOTHER FORMER RESIDENCE IS FIVE WEST HUNTINGTON DRIVE, ARCADIA,
CALIFORNIA. WIFE BELIEVED TO BE GISELLA FOX ACCORDING TO CLETS
RECORDS.

SAO IS A PARA MILITARY RIGHT WING EXTREMIST ORGANIZATION FROM
THE SAN DIEGO AREA.

FOREGOING IS FURNISHED FOR INFORMATION IN VIEW OF SUBJECT'S
PROPENSITY FOR VIOLENCE. SAN DIEGO HAS NO INFORMATION ~~XXXXXXXXXX~~
THAT
~~XXXXXXXXXX~~ SUBJECT'S VISIT TO WASHINGTON, D.C. INVOLVES A THREAT TO
ANY GOVERNMENT OFFICIAL OR NATIONAL FIGURE.

ADMINISTRATIVE:

JOHN KEEFE, U. S. SECRET SERVICE, SAN DIEGO ADVISED BY SA EARL M.
PETERSEN AT FOUR TWENTY PM INSTANT DATE.

SOURCE WHO FURNISHED ABOVE INFORMATION IS INFORMANT

LOS ANGELES FURNISH BUREAU, SECRET SERVICE AND SAN DIEGO AVAILABLE
BACKGROUND INFORMATION RE SUBJECT.

NO LHM BEING SUBMITTED

PENDING.

Date prepared

5/15/72

Date received

2/8/72

Received from (name or symbol number)

~~_____~~ Informant

Received by

SA STEVEN L. CHRISTENSEN

Method of delivery (check appropriate blocks)

in person

by telephone

by mail

orally

recording device

written by Informant

If orally furnished and reduced to writing by Agent:

Date

Dictated

5/13/72

to

Dictaphone

Date of Report

2/8/72

Transcribed

5/14/72

Authenticated
by Informant

6/15/72

Date(s) of activity

Current

Brief description of activity or material

Info re members and activities of SAO

File where original is located if not attached

* INDIVIDUALS DESIGNATED BY AN ASTERISK (*) ONLY ATTENDED A MEETING AND DID NOT ACTIVELY PARTICIPATE. VIOLENCE OR REVOLUTIONARY ACTIVITIES WERE NOT DISCUSSED.

Information recorded on a card index by _____ on date _____

Remarks:

- ① - SD 170-286A - 255
- 1 - SD 157-1820 (YACOPEC)
- 1 - SD 157-3017 (HOOVER)
- 1 - SD 157-3001 (DAVIS)
- 1 - SD 100-14819 (GODFREY)
- 1 - SD 100-14301 (RUPLINGER)
- 1 - SD 100-15355 (BUSCH)
- 1 - SD 157-2815 (SAO)

INDEX: CY ANDERSON to 157-2815.

157-2815-28

1 - Seattle (CY ANDERSON)

of

Block Stamp

170-286A-155

SEARCHED	INDEXED
SERIALIZED	FILED
MAY 17 1972	
FBI - SAN DIEGO	

Christensen

JEROME
2/8/72

FRANK YACOPEC and GEORGE HOOVER have been getting together lately and may decide to start working together on some of their weird projects.

As I mentioned before, the Yuma Gun Show is coming up on the 25th, 26th & 27th of this month. CY ANDERSON will be down from Seattle to go to the show. He will come to San Diego first and spend a few days here selling various things that he is bringing down. SAM DAVIS and BARRY GODFREY are also going to the gun show. It is expected that EV MOORE will be there from Phoenix, and that there will be organizational meetings of the SAO during the gun show.

PAUL RUPLINGER has already put in an order for \$800 worth of the stuff which CY ANDERSON is bringing down from Seattle. This stuff is supposed to include some military-type sleeping bags, rifles, ammunition, etcetera.

The San Diego Public Library maintains a name index on all persons whose names figure prominently in the local newspapers. It appears that someone has gone through this index and systematically removed the names of all individuals with Left Wing connections. RUPLINGER was quite upset about this and said he had a friend he would check with about it.

SAM DAVIS was also by the other day and said he was looking for ten fuse-type blasting caps, but did not say what for.

JERRY LEE BUSCH has become a pain in the neck for the local people because of the trouble and commotion he has caused and because of being so untrustworthy. DAVIS and others will make efforts to get him to leave town by

making him think that the Left Wingers are out to get him.

He also indicated that the SAO is giving up to put out another special intelligence bulletin in the near future.

Jerome

Date prepared

5/15/72

Date received

2/11/72

Received from (name or symbol number)

~~_____~~ Informant

Received by

SA STEVEN L. CHRISTENSEN

Method of delivery (check appropriate blocks)

in person by telephone by mail orally recording device written by Informant

If orally furnished and reduced to writing by Agent:
Date

Date of Report

Dictated 5/13/72 to Dictaphone

2/11/72

Date(s) of activity

Transcribed 5/11/72

Authenticated by Informant 5/15/72

Current

Brief description of activity or material

Activities of SAO and members

File where original is located if not attached

* INDIVIDUALS DESIGNATED BY AN ASTERISK (*) ONLY ATTENDED A MEETING AND DID NOT ACTIVELY PARTICIPATE IN VIOLENCE OR REVOLUTIONARY ACTIVITIES WERE NOT DISCUSSED.

Information recorded on a card index by _____ on date _____.

Remarks:

- (1) - SD 170-286A - 156
- 1 - SD 157-2815(SAO)
- 11 - SD 157-3224(NSAWP)
- 1 - SD 157-1813(HAUGHTON)
- 1 - SD 157-1614(HAUGHTON)
- 1 - SD 157-3005(CONDE)
- 1 - SD 157-1798(M)
- 1 - SD 157-3001(DAVIS)
- 1 - SD 157-2388(SCOTT WINCHESTER)
- 2 - Los Angeles
- 2 - Phoenix

~~INDEXED~~

No action has been taken at this time regarding the alleged possession of weapons by two individuals at Los Angeles as their identities are not yet known and also to avoid compromise the informant.

170-286A-156
Block Stamp

SEARCHED	INDEXED
SERIALIZED	FILED
MAY 17 1972	
FBI - SAN DIEGO	
<i>Christensen</i>	

JEROME
2/14/72

I was in contact with SAM DAVIS this morning. He told me that over last weekend, the SAO had received mail from an individual at Phoenix, Arizona, who is the area leader there of the National Socialist American Worker's Party for SCOTT WINCHESTER at Los Angeles. DAVIS said this individual was formerly a member of the Minutemen Organization but had lost contact with that group and had begun associating with the Nazi's. In his letter, this individual said he had heard of the SAO and he and his entire group were interested in joining.

DAVIS said he had also talked to BETTIE HAUGHTON over the weekend. She told DAVIS she had been contacted recently by two individuals from Covina. She described these persons as formerly trusted leaders in the Minutemen Organization under her husband, TROY. She said these persons were interested in joining the SAO. One of them is supposedly moving to the State of Oregon in the near future, and indicated he would organize for the SAO there.

She also told DAVIS that her husband, TROY, had once borrowed money from these individuals and in return had given them, as security, two 81 milimeter mortars with a number of rounds of ammunition and a case of 36 grenades. The amount of money owing on these weapons is about \$100. SAM said he might sell some of the grenades at \$10 apiece to pay off this debt. He also claimed that he can get additional rounds for the 81 milimeter mortars at \$10 apiece, but did not say where or how. We should be in contact with these individuals from Covina in the near future, and I will try then to learn more about them.

It is well known that TROY HAUGHTON had a habit of borrowing money around from among his friends. When I was last at LOU CONDE's place, I saw an I.O.U. there to him from TROY for \$500.

It is also possible that the two individuals from Covina may know the whereabouts of the Army Field Hospital which TROY HAUGHTON is supposed to have stashed.

DAVIS also indicated that the SAO may put out a poster this weekend in the form of a wanted poster showing President NIXON to be wanted for treason in connection with his trip to China.

Jerome

Date prepared

5/15/72

Date received

2/17/72

Received from (name or symbol number)

~~XXXXXXXXXX~~ Informant

Received by

SA STEVEN L. CHRISTENSEN

Method of delivery (check appropriate blocks)

in person by telephone by mail orally recording device written by Informant

If orally furnished and reduced to writing by Agent:

Date

Dictated 5/13/72 to Dictaphone

Transcribed 5/14/72

Authenticated by Informant 5/15/72

Date of Report

2/17/72

Date(s) of activity

Current

Brief description of activity or material

Info re CALVIN FOX as new member of SAO and other Right Wing activities in area

File where original is located if not attached

* INDIVIDUALS DESIGNATED BY AN ASTERISK (*) ONLY ATTENDED A MEETING AND DID NOT ACTIVELY PARTICIPATE IN VIOLENCE OR REVOLUTIONARY ACTIVITIES WERE NOT DISCUSSED.

Information recorded on a card index by _____ on date _____

Remarks:

- ① - SD 170-286A - 157
- 1 - SD 157-3170 (FOX)
- 1 - SD 157-2815 (SAO)
- 1 - SD 157-3017 (HOOVER)
- 1 - SD 100-14805 (PAULA THARP)
- 1 - SD 100-15450 (PETER BOHMER)

COPIES DESTROYED

INDEX TO 157-2815: LLOYD PULLEN, TOM OSBORNE, CARL MC INTYRE, THOMAS HAY, LILA BUCK, ~~PAULA THARP~~, ~~PETER BOHMER~~, DICK DEXTRAZE.

EF

170-286A-157
Block Stamp

SEARCHED	INDEXED
SERIALIZED	FILED
MAY 17 1972	
FBI - SAN DIEGO	

Christensen

JEROME
2/17/72

I learned this morning from BARRY GODFREY that he had been in contact with an individual named CALVIN FOX. FOX has just recently moved to the San Diego area from Los Angeles, and is operating a Gulf Service Station at the corner of Mollison and Broadway in El Cajon, California. FOX was supposedly a former member of the Minutemen Organization at Los Angeles and has Minutemen Serial Number A60065. The A on the serial number may mean that he was recruited by an individual named LLOYD PULLEN. FOX claims to have been married about four years ago to a girl from Yugoslavia at London, England.

FOX was recommended to GODFREY by his letter carrier, TOM OSBORNE. It appears that FOX may be the next new member of the SAO and that OSBORNE may also join some time in the future.

It has come to my attention that the Reverend CARL MC INTYRE is coming to town next Wednesday, and will speak at a rally and picket to take place in front of the main U.S. Post Office in downtown San Diego, to protest President NIXON's trip to China. This appearance on the part of MC INTYRE is being sponsored by TIM O'HAY, LILA BUCK and others of the SCOTT Memorial Baptist Church in San Diego.

GEORGE HOOVER claims that he got a telephone call from either/or both the Gunsmoke Ranch and the Fleury Ranch in Harbison Canyon, that officers from the San Diego Police Department had been there looking for him. He said he was later interviewed at his residence by these police officers, who told him they had received an anonymous telephone call informing them that HOOVER was a member of the SAO, and that he had been involved in the shooting of PAULA THARP at the residence of PETER BOHMER. HOOVER said he simply told them he was not a

member of the SAO and that he did not know anything about the shooting incident. HOOVER said he suspects that the anonymous telephone call may have been made by DICK DEXTRAZE who frequently hangs around the Fleury place in Harbison Canyon.

Jerome

Date prepared

5/15/72

Date received

2/21/72

Received from (name or symbol number)

INFORMANT

Received by

SA STEVEN L. CHRISTENSEN

Method of delivery (check appropriate blocks)

in person by telephone by mail orally recording device written by Informant

If orally furnished and reduced to writing by Agent:

Date

Dictated 5/13/72 to Dictaphone

Transcribed 5/14/72

Authenticated by Informant 5/15/72

Date of Report

2/21/72

Date(s) of activity

Current

Brief description of activity or material

Info re activities of Secret Army Organization

File where original is located if not attached

* INDIVIDUALS DESIGNATED BY AN ASTERISK (*) ONLY ATTENDED A MEETING AND DID NOT ACTIVELY PARTICIPATE. VIOLENCE OR REVOLUTIONARY ACTIVITIES WERE NOT DISCUSSED.

Information recorded on a card index by _____ on date _____

Remarks

- 1 - SD 170-286A-158
- 1 - SD 157-2815(SAO)
- 1 - SD 100-14819(GODFREY)
- 1 - SD 157-3017(HOOVER)
- 1 - SD 157-1813(PCTO)
- 1 - SD 100-14301(RUPLINGER)
- 1 - SD 157-3001(DAVIS)
- 1 - SD 157-2831(EV MOORE)
- 1 - SD 100-14299(LYLE MANNING)

INDEX: CY ANDERSON, JESSE CLAYBURN STEVENS, AND ~~LYLE MANNING~~ to 157-2815.

No action has been taken at this time with regard to the 81 mm mortars, etc., inasmuch as the identities of the individuals allegedly in possession of them are not known, and to avoid compromising the informant.

170-286A-158
Block Stamp

SEARCHED	INDEXED
SERIALIZED	FILED
MAY 17 1972	
FBI - SAN DIEGO	

Christensen

JEROME
2/21/72

SAM DAVIS claims there will be a meeting tomorrow between him and BARRY GODFREY and the two individuals from Covina, California, to make the transfer of the two 81 milimeter mortars and the box of hand grenades. DAVIS said he will put up half of the money required and wants GODFREY to come up with the other \$50. The meeting will take place at a "safe" house somewhere in the area at about 2:00 in the afternoon. DAVIS will come by GODFREY's house and then they will go to make the meeting in GODFREY's truck, a white Ford Shortbed Pick-up Truck, with a small camper on the back, and with California license 99704F. After obtaining the mortars and hand grenades, DAVIS claims he will leave them at some other house he has in mind.

According to DAVIS, the SAO has elected to go ahead with printing and putting out the wanted posters on President NIXON. According to DAVIS, PAUL RUPLINGER will finance the printing which will be done by BETTIE HAUGHTON. The original plan is to contract for 10,000 copies of the posters and to have them distributed by CY ANDERSON in the Seattle, Washington area; EV MOORE, at Phoenix, Arizona; LYLE MANNING, in the State of Utah; JESSE CLAYBURN STEVENS, at Baltimore, Maryland; and of course all over the San Diego area.

Apparently, there was an article which appeared in the February 9, 1972, issue of the "Daily Aztec", which must have greatly disturbed the Left Wingers on that campus as they went around and gathered up all the copies of the paper they could find and then burned them. The burning of the papers was carried on television. If needed, I have a copy of that issue of the paper.

Jerome

Date prepared

5/15/72

Date received

2/22/72

Received from (name or symbol number)

~~Informant~~ Informant

Received by

SA STEVEN L. CHRISTENSEN

Method of delivery (check appropriate blocks)

in person by telephone by mail orally recording device written by Informant

If orally furnished and reduced to writing by Agent:

Date

Dictated 5/13/72 to Dictaphone

Transcribed 5/21/72

Authenticated by Informant 5/15/72

Date of Report

2/22/72

Date(s) of activity

Current

Brief description of activity or material

Info re activities of JERRY LYNN DAVIS and

Secret Army Organization

File where original is located if not attached

157-2815

* INDIVIDUALS DESIGNATED BY AN ASTERISK (*) ONLY ATTENDED A MEETING AND DID NOT ACTIVELY PARTICIPATE. VIOLENCE OR REVOLUTIONARY ACTIVITIES WERE NOT DISCUSSED.

Information recorded on a card index by _____ on date _____

Remarks:

- ① SD 170-286A-159
- 1 - SD 157-2815(SAO)
- 1 - SD 157-3001(DAVIS)
- 1 - SD 157-3017(HOOVER)
- 1 - SD 100-15622("O.B. RAG")

INDEX: DICK DEXTRAZE to 157-2815

No action being taken regarding weapons mentioned herein as the allegations have so far failed to materialize.

g

Louise - put copies of SAO literature in 157-2815 only -

Block Stamp

170-286A-159

SEARCHED	INDEXED
SERIALIZED	FILED
MAY 17 1972	
FBI - SAN DIEGO	

Christensen jll

JEROME
2/22/72

I understand that DAVIS received a telephone call this morning from the two individuals at Covina, California, who called to say that they would not be able to deliver the two 81 milimeter mortars and the box of hand grenades as arranged. They explained they had buried these items and were unable to locate them when they went to dig them up. They said they would try to get a metal detector and look for them again. However, it appears this operation may be postponed for an indefinite period of time.

The individual named DICK DEXTRAZE, who has been staying at the Fleury Place in Harbison Canyon, is again suspected of being an infiltrator. GEORGE HOOVER fed DEXTRAZE some phony information to the effect that local Right Wingers are maintaining a fully armed war plane at a landing field in the San Diego area. In less than a week, this information was printed in the most recent issue of the "O.B. Rag". HOOVER and others are talking about making DEXTRAZE the subject of an object lesson for the Left Wingers.

The President NIXON wanted posters are to go to press today and to be on the streets Monday. The number of copies to be printed has been reduced to 5,000. The format of the posters will be as follows:

At the top will be the words Wanted For Treason, below which will appear a photograph of the President, and underneath that a description including his last known address. At the bottom will be a suggestion that the President be impeached and be tried for treason by the proper authorities.

Attached are copies of all the recent publications and other papers of the SAO.

Jerome

Date prepared

5/16/72

Date received

2/28/72

Received from (name or symbol number)

Informant

Received by

SA STEVEN L. CHRISTENSEN

Method of delivery (check appropriate blocks)

in person by telephone by mail orally recording device written by Informant

If orally furnished and reduced to writing by Agent:

Date

Dictated 5/15/72 to Dictaphone

Transcribed 5/15/72

Authenticated by Informant _____

Date of Report

2/28/72

Date(s) of activity

Current

Brief description of activity or material

Info re incident at residence of RICHARD

FLEURY

File where original is located if not attached

* INDIVIDUALS DESIGNATED BY AN ASTERISK (*) ONLY ATTENDED A MEETING AND DID NOT ACTIVELY PARTICIPATE. VIOLENCE OR REVOLUTIONARY ACTIVITIES WERE NOT DISCUSSED.

Information recorded on a card index by _____ on date _____

Remarks:

- ① - SD 170-286A - 160
- 1 - SD 157-2933 (MC DACE)
- 1 - SD 157-3017 (HOOVER)
- 1 - SD ~~157~~ 100-15355 (BUSH)

INDEX TO 157-3017; RICHARD FLEURY, GENEVIEVE FLEURY, DICK DEXTRAZE.

The San Diego Police Department and San Diego County Sheriff's Department were appropriately advised of attached information at the time received. It is noted that the Sheriff's Office was called in to investigate the altercation between FLEURY and his wife.

Block Stamp

170-286A-160

SEARCHED	INDEXED
SERIALIZED	FILED
MAY 19 1972	
FBI - SAN DIEGO	

Christensen

JEROME
2/28/72

I was talking with STAN MC DADE last week. We were discussing the situation at the residence of RICHARD and GENEVIEVE FLEURY in Harbison Canyon. According to MC DADE, RICHARD FLEURY claims that on the morning of Saturday, 2/19/72, he was walking out in his front yard when someone shot at him four times from across the canyon. Following this, his wife, already upset by his friends and activities, came unglued and hit him over the head with a lamp, following which a big fight resulted. She told him that because of his friends and activities, he was going to get her and all of their children killed. The Sheriff's Office was called and FLEURY moved out and went to stay with GEORGE HOOVER at his place. MC DADE said GENEVIEVE FLEURY later called the Sheriff's Office and them come and pick up all of her husband's guns including a .9 milimeter pistol, which they seemed very elated to find. MC DADE said HOOVER and RICHARD FLEURY are blaming the shooting incident on JERRY LEE BUSCH, and DICK DEXTRAZE, who sometimes stays at the FLEURY place. When RICHARD FLEURY went back to get his guns, he supposedly found DEXTRAZE there with his wife. MC DADE fears that HOOVER and FLEURY may attempt to take some drastic action against DEXTRAZE believing that he has been breaking the FLEURY family up.

MC DADE said that BUSCH is apparently leaving for Canada today to take a job there and may be doing so because HOOVER is so angry at him.

Jerome

Date printed

5/16/72

Date received

3/8/72

Received from (name or symbol number)

~~XXXXXXXXXX~~ Informant

Received by

SA STEVEN L. CHRISTENSEN

Method of delivery (check appropriate blocks)

in person by telephone by mail orally recording device written by Informant

If orally furnished and reduced to writing by Agent:

Date

Dictated 5/14/72 to Dictaphone

Transcribed 5/15/72

Authenticated by Informant 5/15/72

Date of Report

3/8/72

Date(s) of activity

Current

Brief description of activity or material

Info re activities of SAO and members.

File where original is located if not attached

* INDIVIDUALS DESIGNATED BY AN ASTERISK (*) ONLY ATTENDED A MEETING AND DID NOT ACTIVELY PARTICIPATE. VIOLENCE OR REVOLUTIONARY ACTIVITIES WERE NOT DISCUSSED.

Information recorded on a card index by _____ on date: _____

Remarks:

- ① - SD 170-286A-161
- 1 - SD 157-2815(SAO)
- 1 @ SD 157-3001(DAVIS)
- 1 - SD 157-3169(HARTLEY)
- 1 - SD 157-1816(POTOJ)
- 1 - SD 157-3170(FOX)
- 1 - SD 100-14819(GODFREY)
- 1 - SD 157-3017(HOOVER)
- 1 - SD 100-15355(BUSHG)
- 2 - SD 157-nw(GILCARRUDA) @

INDEX TO ~~157-2815~~ ^{0 02} ~~SIS ARRUDA~~. TO 157-3017: RICHARD FLEURY, GENEVIEVE FLEURY.

slp

Block Stamp

170-286A-161

SEARCHED	INDEXED
SERIALIZED	FILED
MAY 17 1972	
FBI - SAN DIEGO	

Christensen

JEROME
3/8/72

I would estimate that the SAO has received approximately \$300 to \$400 now in donations, membership application fees, and monthly dues. SAM DAVIS has been keeping this money and most of it has been spent on printing and postage costs for the SAO. DAVIS told me that DONNA LEE HARTLEY of Vista, California, recently sent \$15 into the SAO with a letter requesting all of the SAO training literature.

Apparently, the plans which JIM POTO had of going back to the Chicago, Illinois area to open up a new restaurant there for the restaurant chain he works for have not materialized. It looks as though POTO will remain in the San Diego area for the time being and will help BARRY GODFREY and DAVIS organize for the SAO. DAVIS has asked GODFREY to do a new special intelligence bulletin for the SAO on some leading figure in the New Left Movement in the San Diego area.

I have heard no new information on the situation at the FLEURY place in Harbison Canyon.

J ~~GODFREY~~ DAVIS claims that an individual named GIL ARRUDA may join the SAO in the near future and may allow the SAO and its members to use his place for firearms practice and training purposes. ARRUDA has about 190 acres of open land up in Wild Cat Canyon above Lakeside. DAVIS said he has been thinking about working out a method of moving up to this place to live on it.

I have been given the assignment of going out to sign up CALVIN FOX as a member of the SAO and will do so today.

Some consideration has been given to having GEORGE HOOVER come out in the open as a public recruiting officer for the SAO. HOOVER claims to have heard from

GENEVIEVE FLEURY that JERRY LEE BUSCH was supposedly stopped and arrested at the Canadian Border. BUSCH was going into Canada to work there at a radio station which is owned and operated by a friend of his.

Genevieve

Date prepared

5/16/72

Date received

3/10/72

Received from (name or symbol number)

[Redacted] Informant

Received by

SASTEVEN L. CHRISTENSEN

Method of delivery (check appropriate blocks)

in person by telephone by mail orally recording device written by Informant

If orally furnished and reduced to writing by Agent:

Date

Dictated 5/14/72 to Dictaphone

Transcribed 5/15/72

Authenticated by Informant 5/14/72

Date of Report

3/10/72

Date(s) of activity

Current

Brief description of activity or material

Info re CALVIN FOX

File where original is located if not attached

* INDIVIDUALS DESIGNATED BY AN ASTERISK (*) ONLY ATTENDED A MEETING AND DID NOT ACTIVELY PARTICIPATE
VIOLENCE OR REVOLUTIONARY ACTIVITIES WERE NOT DISCUSSED.

Information recorded on a card index by _____ on date _____

Remarks:

- ① - SD 170-286A-162
- 1 - SD 157-2815(SAO)
- 1 - SD 157-3170(FOX)

It is noted that on 5/16/72, LOUIS VIENS, Area Representative, Gulf Oil Company, 3230 Jefferson, San Diego, advised that prior to becoming a Gulf dealer, FOX had been involved with a Mobil service station in the downtown San Diego area.

It is recommended that Agents be alerted and cautioned against purchasing gasoline for Bureau cars at the Subject's service station.

*Christensen -
Prof. all agents
memo -
Done
5/16/72*

Block Stamp

170-286-162

SEARCHED	INDEXED
SERIALIZED	FILED
MAY 19 1972	
FBI - SAN DIEGO	

JEROME
3/10/72

CALVIN FOX was signed up today as a member of the SAO. He paid his initiation fees and first months' dues, etcetera. FOX claimed that he used to work at a mobile gas station located in the 1100 block of 11th Avenue in downtown San Diego. He said that many FBI Agents used to bring their cars there to gas up and he claimed to have taken down the license plate numbers of these cars and to have kept photocopies of the Agents' signatures and credit card numbers.

Jerome

Case Sheet for Informant Report or Material
FD-306 (Rev. 9-30-69)

Date prepared
5/18/72

Date received
3/11/72

Received from (name or symbol number)
~~XXXXXXXXXX~~ Informant

Received by
SA STEVEN T. CHRISTENSEN

Method of delivery (check appropriate blocks)
 in person by telephone by mail orally recording device written by Informant

If orally furnished and reduced to writing by Agent:
Date
Dictated 5/14/72 to Dictaphone
Transcribed 5/15/72
Authenticated by Informant 5/15/72

Date of Report
3/11/72

Date(s) of activity
Current

Brief description of activity or material
Info re activities of SAO and members.

File where original is located if not attached

* INDIVIDUALS DESIGNATED BY AN ASTERISK (*) ONLY ATTENDED A MEETING AND DID NOT ACTIVELY PARTICIPATE. VIOLENCE OR REVOLUTIONARY ACTIVITIES WERE NOT DISCUSSED.
 Information recorded on a card index by _____ on date _____

Remarks:
1 - SD 157-2815(SAO)
① - SD 170-286A-163
1 - SD 157-2813(HAUGHTON)
1 - SD 157-3001(DAVIS)
1 - SD 157-3169(HARTLEY)

Handwritten initials

Block Stamp
170-286A-163
SEARCHED
SERIALIZED
MAY 19 1972
FBI - SAN DIEGO
Christensen

JEROME
3/11/72

SAM DAVIS called me this morning and said he had been talking to BETTIE HAUGHTON. Apparently, she is about ready to leave San Diego and go up to Big Pine, California, where she will live and eventually be married. According to DAVIS, BETTIE has a miniature Minox camera, which she wanted to sell for about \$50. DAVIS said she went to a camera store and found she could only get \$30 for the Minox. She was kind of upset about this and said she would rather let the SAO have it for \$25 for the use of the organization. SAM and I will go by her place tomorrow and pick it up from her. I will also find out then exactly when she is leaving town.

SAM said he wants me to go with him tomorrow to see the new female SAO member at Vista, named DONNA LEE HARTLEY.

Jerome

Date prepared
5/16/72

Date received
3/13/72

Received from (name or symbol number)
Informant

Received by
SA STEVEN L. CHRISTENSEN

Method of delivery (check appropriate blocks)

in person by telephone by mail orally recording device written by Informant

If orally furnished and reduced to writing by Agent:

Date of Report

Dictated 5/14/72 to Dictaphone

3/13/72

Transcribed 5/15/72

Date(s) of activity

Authenticated by Informant 5/15/72

Current

Brief description of activity or material

Info re SAO and activities of members

File where original is located if not attached

* INDIVIDUALS DESIGNATED BY AN ASTERISK (*) ONLY ATTENDED A MEETING AND DID NOT ACTIVELY PARTICIPATE. VIOLENCE OR REVOLUTIONARY ACTIVITIES WERE NOT DISCUSSED.

Information recorded on a card index by _____ on date _____

Remarks:

- ① - SD 170-286A-164
- 1 - SD 157-2815(SAO)
- 1 - SD 157-2933(MC DABE)
- 1 - SD 157-3017(HCOVER)
- 1 - SD 157-28(NSWPP)
- 1 - SD 157-3086(KOEHL)
- 1 - SD 157-1813(HAUGHTON)
- 1 - SD 157-3001(DAVIS)
- 1 - SD 157-1816(POTO)
- 1 - SD 157-14298(FRED HAWES)
- 1 - SD 100-14819(GODFREY)
- 1 - SD 157-1614(HAUGHTON)
- 1 - SD 157-1798(MAR)
- 1 - SD 157-3007(GUIRE)

INDEX TO 157-1798: VAL BOYLE, ALICE DUNN.

Info. regarding Hoover furnished to Thomas Clovis, IRS, San Diego, on 6/20/72. me

*Christensen file
Pdz dissemination to inform
Hoover by IRS re: meeting of
on this FD 302 re: membership of
The IRS re: subject
W*

Block Stamp

170-286A-164

SEARCHED	INDEXED
SERIALIZED	FILED
MAY 18 1972	
FBI - SAN DIEGO	

JEROME
3/13/72

I understand that STAN MC DADE and GEORGE HOOVER went to El Monte, California, last Saturday night to hear MATT KOEHL, National Commander of the NSWPP, speak. MC DADE also said he was going to attend the rally at the San Diego NSWPP Headquarters yesterday, to hear KOEHL speak.

I went to see BETTIE HAUGHTON yesterday and got the Minox camera together with four rolls of film and three gas masks. She said she is going to leave town within two weeks. SAM DAVIS was also with me and she gave SAM some keys to a garage where all of the old Minutemen camp gear is located. This stuff includes cots, stoves, medical supplies, etcetera. She also told SAM that a large quantity of explosives is supposedly buried under the house of VAL BOYLE, TROY HAUGHTON's mother.

I also understand that JIM POTO and FRED HAWES know something about this garage and have some of their stuff stored there too. HAWES used to live with BETTIE HAUGHTON and she and JIM POTO are on very good terms.

When SAM DAVIS and BARRY GODFREY were at the Yuma Gun Show weekend before last, they met with EV MOORE and discussed a few details and plans about the SAO but nothing very extensive. Apparently, there is a rumor going around that ROBERT DE PUGH, former National leader of the Minutemen Organization, may already be trying to make a comeback even though he is still in prison. This rumor is based on the fact that certain individuals who did a lot of work for him and for the Ku Klux Klan in the southwest are now highly placed in the Liberty Lobby which is now setting up survival groups and an underground organizational and communications network. It is believed that all of this activity may be part of plans for DE PUGH to come back and take over again. One of the individuals involved in these activities is ALICE DUNN, who was formerly in the organization named

American Volunteer Groups, and also worked for DE PUGH as a fund raiser.

At the suggestion of EV MOORE, the new SAO introduction letter and recruiting literature will be sent out along with a coded coupon which will have only a number rather than the recipient's name, for him to use to request more information if interested in the SAO.

MOORE, who is supposed to be a master locksmith, indicated he would write a bulletin for the SAO on how to jimmy doors and also an advanced training bulletin on lock picking and safe cracking.

BARRY GODFREY is to be the official SAO photographer and a part of his duties will include taking and editing photographs of SAO training sessions to be used for publicity.

WALT GUIRE's name was mentioned as one who might give propaganda lectures.

The SAO will also, in the near future, publish a bulletin on what members should do when they are interviewed by the law. This bulletin will include suggestions such as keeping a loaded camera by the door in order to take photographs of the interviewing officials, obtaining the name and badge number of these officials and make them wait while the appropriate agency is called to verify their identity. BETTIE HAUGHTON has said she once caught some ATFD Agents using FBI identification in their interviews. These procedures are also a harrassment tactic which may hopefully frighten away less serious minded interviewers.

GEORGE HOOVER claims he has not filed a Federal income tax return for several years. It is possible that some of the others such as DAVIS may also not have filed returns when required. HOOVER also claims to have been married twelve to fourteen years ago, but to have separated from his wife after living together for only a short while. HOOVER and DAVIS have known each other for approximately ten years.

Jerome

SAC (160-New)

5/12/72

SA EARL M. PETERSEN

UNSUB; ATTEMPT TO STOP TRAINS, 15th STREET
DEL MAR, CALIFORNIA, 5:00 PM 5/12/72.
FEDERAL TRAIN WRECK STATUTE

On this date the following information has been received:

At 9:30 am ^{InFormant} advised that he has received information from sources who have furnished reliable information in the past that Anti-war demonstrators who have been demonstrating in San Diego in the past few days will go to Del Mar, California today at 5:00 pm to try to stop trains passing by the 15th Street area of the city.

At 10:00 AM ^{InFormant} advised SA ~~XXXXXXXXXXXXXXXXXXXX~~ C. JORDAN NAYLOR that at a meeting at San Diego State College during the night of Thursday 5/11/72, a schedule of proposed anti-war activities was announced. They included a 5:00 pm meeting on 5/12/72 at 15th Street in Del Mar, California for the purpose of "stopping the train."

At 9:50 am 5/12/72, ^{InFormant} telephonically contacted SA Steven L. CHRISTENSEN to advise that he had contacted the rumor control center at SDEC, telephone 532-4357, and had been advised that ANTI-War Demonstrators will attempt to stop trains at 15th Street, Del Mar, California at 5:00 pm 5/12/72.

Investigator GEORGE CARR, DA's Office, San Diego, telephonically contacted the writer advising that he had been in contact with SA STRICKLER, Santa Fe Railroad, Los Angeles, California, telephone 628-0111 Ext. 33652 who advised him that an SA SKOW of San Bernardino is enroute to Del Mar RR station to act as representative for the railroad in any attempt to stop the trains there today. SA STRICKLER advised that their information is that the demo. to stop the trains will start at 12:15 pm 5/12/72. He furnished train schedule as follows:

Freight train northbound 7:30 pm 5/12/72 carrying general merchandise - freight will stop at Del Mar today.

2-100 NEW	Passenger southbound	XXXXXXXXXXXX	12:15
1-134-1052 ()	" northbound		4:30 p
170-156A ()	" northbound		7:15 p
1-134-1030A ()	" southbound		9:30 p

SEARCHED	INDEXED
SERIALIZED	FILED
MAY 15 1972	
FBI - SAN DIEGO	

There will be a small freight train leaving San Diego which will not go through Del Mar later in the day.

170-286A-165

Date prepared
5/4/72

Date received
1/28/72

Received from (name or symbol number)
~~XXXXXXXXXX~~ Informant

Received by
STEVEN L. CHRISTENSEN

Method of delivery (check appropriate blocks)
 in person by telephone by mail orally recording device written by Informant

If orally furnished and reduced to writing by Agent:
Date
Dictated 5/4/72 to CAROL HOLMES
Transcribed 5/30/72
Authenticated by Informant _____

Date of Report
1/28/72

Date(s) of activity
1/28/72

Brief description of activity or material
Contact of LOU CONDE by SAO for financing

File where original is located if not attached

* INDIVIDUALS DESIGNATED BY AN ASTERISK (*) ONLY ATTENDED A MEETING AND DID NOT ACTIVELY PARTICIPATE. VIOLENCE OR REVOLUTIONARY ACTIVITIES WERE NOT DISCUSSED.
 Information recorded on a card index by _____ on date _____

Remarks:
157-2815 (SAO)
~~170-286A-166~~
157-3005 (CONDE)
100-14819 (GODFREY)
157-3001 (DAVIS) ----- copies continued next page

ACTION: Index GENE BOSARTH, RICHARD FLEURY, and GENEVIEVE FLEURY to 157-2815.

Information pertaining to the RNC was appropriately disseminated when received.

With regard to information pertaining to RON ZARICK, no action has been taken inasmuch as ATFD at San Diego is already well aware of his activities and due to the fact that it does not appear specific action in this regard could be taken without exposing the source.

Block Stamp
170-286A-166
SERIALIZED
MAY 7 1972
FBI - SAN DIEGO
W
P. 41

2-0 (NEUTRALITY MATTERS)
 67-3001 (SUNDQUIST) 28, 1972
 157-2921 (ZARICK)
 157-2933 (MC DADE)
 157-2546 (CLARK)
 157-3169 (DONNA LEE HARTLEY)
 157-3017 (HOOVER)
 100-16200 (RNC)
 100-15355 (BUSCH)
 157-28 (NSWPP)
 157-201 (SMITH)

2- Los Angeles
 (1 - SCOTT WINCHESTER)
 (1 - NSWPP)
 3- Phoenix
 together (1 - SAO)
 (1 - EV MOORE)
 generator (1 - TOM PAINE)

He also agreed to send the SAO some money and said he would get support for the organization from certain other people and would put the SAO in contact with the underground Cuban Refugee Organization, Alpha 66.

Apparently CONDE is running for election to the County Board of Supervisors for the seat now held by [unclear]. He claims to have the backing of both the [unclear] and [unclear] from Councils. He is also supposed to be chairman of a couple of local [unclear] associations. He is also registered in the Republican Party for his previous [unclear] offices in [unclear].

CONDE claimed to [unclear] and GODFREY that [unclear] Special Agent of the FBI at San Diego named "WAL. SUNDQUIST".

JEROME

JANUARY 28, 1972

I was told by BARRY GODFREY that he and SAM DAVIS went to see LOU CONDE this morning to ask him to help finance some of the SAO's activities. When contacted, CONDE donated a complete "Angry Thirteen" military radio set to the SAO together with all of the antennas, crystals, the hand crank, generator repair kit, etc. This is to be picked up later. He also agreed to send the SAO some money and said he would get support for the organization from certain other people and would put the SAO in contact with the underground Cuban Refugee Organization, Alpha 66.

Apparently CONDE is running for election to the County Board of Supervisors for the seat now held by WALTER SCHEIDLE. He claims he has the backing of both the La Jolla and Clairemont Town Councils. He is also supposed to be chairman of a couple of local parent associations and is highly regarded in the Republican Party for his previous campaign efforts in behalf of Governor REAGAN.

CONDE claimed to DAVIS and GODFREY that a former Special Agent of the FBI at San Diego named "BOB SUNDQUIRT",

or something similar, had owed him a considerable amount of money and that CONDE had been squeezing this individual for information even before he retired from the FBI. He said the former Agent attempted to pay him off with bad checks which came back marked "insufficient funds". CONDE said he still has these checks and showed DAVIS and GODFREY one for \$200.00. He claimed that the former Agent is now working for him as a carpenter doing boat repair work which CONDE has contracted.

CONDE also talked about the publicity he received in recent months when he offered to outfit and arm a patrol boat to accompany the American tuna fishing fleet to South American waters to keep them from being seized by Latin American Navies. In this regard, he said that many people came to see him from all over the country volunteering to go and work as crew members on such an expedition.

CONDE indicated that he possessed either an M-1 carbine which can be converted to fire fully automatic; or an M-2 carbine, which lacks certain parts in order to fire fully automatic, and asked DAVIS and GODFREY if they would help him put it together. DAVIS said he would do so.

DAVIS also offered to use the organization and facilities of the SAO to assist CONDE in his campaign. This help would include quietly planting literature for CONDE on the SAO printing presses and also to assist him in exposing problems which his opponents may have.

I was in contact yesterday with RON ZARICK. As usual, he was talking about firearms and other things. He claimed he had recently acquired an M-28 Thompson Submachine gun and an M-3 grease gun which he offered to sell to me. He said he wanted to know whether I wanted them by tonight at the latest. He is asking \$200 for the M-28, and \$125 for the M-3. This is more money than I can come up with.

He also claimed he had possession of some hand grenade fuses, some practice grenades, and some smoke grenades. He claimed these things came from a private collection of an individual living somewhere north of San Francisco who was going to bring them down if ZARICK could sell enough of them.

I also received a letter today from GENE BOSARTH, P.O. Box 15662, San Diego, California, and home address 6979 Galewood, San Diego, who has offered to furnish information

to the SAO. He is a student at San Diego State College and either has ties with or access to information about New Left activities on that campus. In his letter, he indicated he had come across some information which he thought might be of interest to the SAO.

In addition, I was talking to STAN MC DADE this morning. He told me he and HOWARD CLELAND were driving out near the Singing Hills Golf Course yesterday when they noticed they were being followed by someone in what they described as a yellow 1970 Mustang with California license 823 E1Y. MC DADE said he and CLELAND took a round-a-bout route to the San Diego Fish and Game Association Range and the yellow car stayed with them all the way. MC DADE said when they got out at the range, he and CLELAND acted like they didn't know the other car had been following them. He said the occupants of the other car also pretended the same thing and came up to MC DADE and CLELAND offering to sell them some riot guns. MC DADE said he and CLELAND were suspicious of a set-up and backed out of the situation saying they would have to think about it.

I have also talked today with SAM DAVIS. He said he believed he had observed a car conducting a moving surveillance of his house. He said the license number on the car was YCD 112. He claimed he did not think the car

was a police department undercover car and thought perhaps some Left Wingers had come up with his address. SAM said this morning he received a Xerox copy of an SAO application form in the mail from one TOM PLINE (phonetic) enclosing \$5.00. The return address was a Post Office box in Tucson, Arizona. If I can, I will get the address later.

EV MOORE also wrote DAVIS and asked if there was any way he and BARRY GODFREY could make it to the Tucson gun show this weekend, as there are some people at Tucson he wants them to meet. He said he also had some good recruitment prospects for the SAO. MOORE is supposed to be a master locksmith and has offered to write a training bulletin for the SAO on lock picking. DAVIS said he would contact HOWARD CLARK who now has a private pilot's license and see if he can rent a plane with CLARK and fly over to Tucson to meet MOORE.

SAM said the SAO had also received a letter from a woman at Vista, California. He said he would give me her name and address later. In the letter, she described herself as a widow with two children and stated she wanted to do something for her country and had been thinking about joining a police or sheriff's reserve unit. However, she said she had heard about the SAO and thought that if it was

truly patriotic, she would rather join it.

SAM said the SAO had received another letter which came from "Newsweek" magazine at Los Angeles asking if the SAO would grant an interview to the magazine. In its letter, "Newsweek" said it was preparing an article dealing with Leftist groups in the San Diego area in connection with the 1972 Republican National Convention. "Newsweek" said it had run across the SAO and would like to do a column on it too. DAVIS said he thought he would like to give such an interview if the meeting could be made secure and if the SAO's Post Office Box number would appear in the article.

SAM said the SAO had also received a nice letter from the "San Diego Evening Tribune" which also wants an interview. He said in its letter, the "Tribune" said the organization appeared secretive and wondered if the SAO would allow the "Tribune" to do an article presenting the organization's views. I understand that this was mentioned to LOU CONDE when DAVIS and GODFREY went to see him and he was very happy about it. He said he knows several people very well at the "Tribune" and would talk to them and get an assurance of favorable treatment of the SAO by the paper. However, DAVIS thinks such an interview might be a little premature

as he feels that certain comments made in the interview might be too much of a slap at the San Diego Police Department.

By the way, when I was talking to STAN, he said he would like to bury some more Mauser rifles because they are cheap. He claims to have already buried some of these rifles. He said the Customs Agent who had wanted to buy a machine gun from him had been back to see him again. MC DADE said he thought the Customs Agent wanted to join the SAO. GODFREY's opinion is that the guy is a real "kook".

MC DADE said that he had been in contact with GEORGE HOOVER. He said HOOVER has been running around with RICHARD and GENEVIEVE FLEURY who live in Harbison Canyon across from the Gunsmoke Ranch. He said that JERRY LEE BUSCH has been living at the FLEURY place off and on and has set up rifle and pistol ranges there where they have been doing some target practice. HOOVER has apparently been out attempting to recruit some members for the SAO and has come up with a couple of prospects from the beach area who are long hairs. He believes these people are Right Wing-oriented but GODFREY says most likely they are attempting to infiltrate the SAO for the Left.

On Saturday, the 15th of January, SCOTT WINCHESTER came down to San Diego from Los Angeles. SAM and STAN met him somewhere and then went to STAN's house to talk. GODFREY met them there later. The discussion lasted for several hours. WINCHESTER advised he was in the process of setting up a headquarters for his organization at Los Angeles. He claimed that he wanted to work with the SAO and said he would offer the SAO the use of his facilities in Los Angeles. Later, DAVIS and GODFREY said they were cool to the idea of forming an alliance with WINCHESTER as they think he is an idiot and is lousy on his security precautions. They said they will gradually break off contact with him.

During the meeting with WINCHESTER, the participants took a break once because WINCHESTER said he wanted to go and talk with some members of the local NSWPP Unit. Because DAVIS and MC DADE are well-known to the local NSWPP, WINCHESTER and GODFREY went, each using assumed names. They talked with GERALD LEE SMITH, leader of the local NSWPP Unit. During the conversation with SMITH, WINCHESTER brought his own name up and SMITH, not knowing whom he was talking to, made many uncomplimentary remarks about WINCHESTER.

After returning to MC DADE's house, WINCHESTER talked a lot about anti-Semitism and how he believed himself

to be a perfect specimen of the Aryan race.

No one I have talked to seems to know who it was who recently passed out SAO literature at the House of Ice in San Diego.

Memorandum

TO : SAC, SAN DIEGO (157-new)

FROM : SA STEVEN L. CHRISTENSEN

SUBJECT: RICHARD MILLER
EM - SAO

DATE: 6/14/72

Bureau instructions have been received to investigate background of all members and other individuals from whom members of the SAO obtain weapons ~~which~~ possession of which may represent a violation of Federal law.

Informant

On 4/26/72 ~~Source~~ advised that approximately six months earlier he had observed JERRY LYNN DAVIS, San Diego area SAO leader, in possession of a fully automatic AR 18 rifle in .223 caliber. DAVIS indicated he had obtained this weapon from RICHARD MILLER, telephone number 583-8078. Source said he did not know MILLER's source of the weapon, but said MILLER was rumored to have contact with the manufacturer of the rifle, Armalite Company, through a stockholder of that company, and in the past has been able to get and sell AR180 rifles (legal civilian version of the AR18) when no one else could get them. Source did not know MILLER's address.

On 4/26/72 review of the current San Diego telephone directory showed a listing for a RICHARD MILLER at 7186 Glenroy, San Diego, with the above telephone number.

On this date, review of the Polk Directory showed that RICHARD MILLER at this address is married to PATRICIA and is employed as a test engineer at Teledyne-Ryan.

In view of the foregoing it is recommended a new 157 case be opened and assigned.

2 - SD 157-new
① - SD 170-236A
SLC/slc
(3)

170-386A-167

SEARCHED	INDEXED
SERIALIZED	FILED
JUN 15 1972	
FBI - SAN DIEGO	

1/16



Buy U.S. Savings Bonds Regularly on the Payroll Savings Plan

UNITED STATES GOVERNMENT

Memorandum

TO : SAC, SAN DIEGO (157-3000)

DATE: 6/20/72

FROM : SA STEVEN L. CHRISTENSEN

SUBJECT: ROGER DRAPEAU
EM - WHG

On 6/16/72 [REDACTED] advised he had heard that the Subject had moved from the San Diego area to Boston, Mass.

On 6/19/72 Miss Jean Harrison, Clerk, U. S. Postal Inspector's Office, San Diego, advised that as of 4/18/72, the Subject had entered a forwarding address of 96 Beverly, Willimawset, Mass., 01109.

LEAD

Will verify Subject's residence and employment in Massachusetts.

① - SD 170-286A
1 - SD 157-3000
SLC/slc
(2)



170-286A-168

SEARCHED	INDEXED
SERIALIZED	FILED
JUN 20 1972	
FBI - SAN DIEGO	

Buy U.S. Savings Bonds Regularly on the Payroll Savings Plan

SAC (157-2815)(P)

6/29/72

SUPERVISOR ANDREW C. GIBSON

SECRET ARMY ORGANIZATION (SAO)
EM

Informant

On 6/29/72, [redacted] advised he had been in conversation with SAO leader SAM DAVIS that morning and DAVIS had indicated to him that through a source in the San Diego Police Department he had learned that there is an informant in the SAO, that extensive stake outs had been conducted by the San Diego Police Department during the period following the bomb of the Guild Theater, that the Police Department had known FRANK YAKOPEC planned to bomb other targets and these targets had been staked out. That stake out officers had been told that YAKOPEC was a psychopath.

DAVIS indicated his source in the Police Department had been involved in the stake outs mentioned above. DAVIS said he was attempting to raise bail money for YAKOPEC in order to get him where he would talk to him in an effort to pin down the identity of the informant.

The above information was furnished to Detective REUBEN BRANDON, San Diego Police Department on a confidential basis on 6/29/72.

1 - 157-2815

1 - 174-531

1 - 170-256 A

ACG:gdh

(3)

170-256-A-170

SEARCHED _____	INDEXED _____
SERIALIZED _____	FILED _____
JUN 30 1972	
FBI - SAN DIEGO	

106

UNITED STATES GOVERNMENT

Memorandum

TO : SAC , SAN DIEGO

DATE: 6/22/72

FROM : SA STEVEN L. CHRISTENSEN

TE CI SI Rx E
 PC PCI PSI R (Prob)

SUBJECT: [REDACTED] Informant

Dates of Contact

6/20/72

File #s on which contacted (Use Titles if File #s not available or when CI provides positive information)

157-1820 FRANK YAKOPEC, EM - SAO

Purpose and results of contact

- NEGATIVE
- POSITIVE
- STATISTIC

Information herein obtained confidentially; informant's name is not to be disclosed in report or otherwise unless it has been decided definitely that he is to be a witness in a trial or hearing.

Has informant shown any indication of emotional instability, unreliability or furnishing false information? NO.

Informant certified that he has furnished all information obtained by him since last contact.

Coverage 157

PERSONAL DATA

① 170-235A
- - 57-1720
1 - 174-531

sl:ejt (3)

170-256A-171
SEARCHED
SERIALIZED
JUL
FBI
[Signature]

FEDERAL BUREAU OF INVESTIGATION

Date of transcription June 22, 1972

HOWARD BARRY GODFREY, 738 Graves, El Cajon, California, furnished the following information:

On June 20, 1972, source advised telephonically that he had read of a bombing which had occurred last evening at the Guild Theater on Fifth Avenue, San Diego, in the morning "Union", on Page B-1. He said upon reading the article he immediately suspected FRANK YAKOPEC. Shortly after reading the paper, he received a telephone call from FRANK YAKOPEC who asked him if he had read the article and then hinted he had been responsible for the incident.

Subsequently source contacted YAKOPEC in person at which time he described the bombing to source as follows:

The bomb was fashioned from a 1/3 pound MPD primer with a blasting cap, six feet of safety fuse and an old cardboard type pull fuse igniter. YAKOPEC told source he approached the theater through an alley or walkway, removed the screen from an air vent and threw the device through the vent into an area under the stage of the theater. He then walked about one block away and waited for the device to detonate. He indicated that even at that distance he could feel the shock from the explosion. Source said YAKOPEC seemed to be greatly elated with the results of the blast and kept saying, "I did it! I did it!" over and over. Source said YAKOPEC, for as long as he has known him, has had a hatred for business establishments dealing in what he considers to be pornographic entertainment. He said YAKOPEC is aware of the location and the identity of the owners of most of such places in the San Diego area and that he has already "cased" approximately half of them.

He said YAKOPEC has available other explosives including one or two more 1/3 pound MPD primers, one or two one pound MPD primers, perhaps a 2 1/2 pound block of C-4 plastic explosive, and a number of blasting caps, all of which are commonly available to individuals associated with "Right Wing" activist groups in the area, and a one hundred foot roll of safety fuse which is not illegal to have.

Interviewed on 6/20/72 at El Cajon, California File # SD 157-1820

SA STEVEN L. CHRISTENSEN

/ejt

6/22/72

by _____ Date dictated _____

This document contains neither recommendations nor conclusions of the FBI. It is the property of the FBI and is loaned to your agency; it and its contents are not to be distributed outside your agency.

SD 157-1320

Memorandum

SAC, [illegible]

DATE 6/22/72

Source said he does not know of anyone else YAKOPEC may have told of his part in the bombing, with the possible exception of his wife who was visiting in Los Angeles at the time, nor did he think there was any particular reason that YAKOPEC would have informed any other person of the incident. Source said this would include other members of the SAO and that this organization was in no way a party to the bombing, which he described as a purely individual act on the part of YAKOPEC caused by his dislike for pornography.

CLASS E
S (Prob)

RE: [illegible]
[illegible]
[illegible]

Information obtained from [illegible]

UNITED STATES GOVERNMENT

Memorandum

TO : SAC SAN DIEGO

DATE: 6/22/72

FROM : SA STEVEN L. CHRISTENSEN

- TE
- CI
- SI
- E
- PC
- PCI
- PSI
- E (Prob)
- E (Ghetto)

SUBJECT: [REDACTED] INFORMANT

Dates of Contact
6/21/72

File #s on which contacted (Use Titles if File #s not available or when CI provides positive information)
157-1820 FRANK YAKOPEC, EM - SAO

Purpose and results of contact

NEGATIVE
 POSITIVE
 STATISTIC

Information herein obtained confidentially; informant's name is not to be disclosed in report or otherwise unless it has been decided definitely that he is to be a witness in a trial or hearing.

Has informant shown any indication of emotional instability, unreliability or furnishing false information?
No.

Informant certified that he has furnished all information obtained by him since last contact.

Coverage 157

PERSONAL DATA

① - 170-286A
1 - 157-1820
1 - 174-531

SLC:ejt (3)

170-286A-172

SEARCHED
SERIALIZED P
JUL
FBI
Peterson B

Memorandum

Date June 22, 1972

DATE 6/22/72

HOWARD BARRY GODFREY, 738 Graves, El Cajon, California, furnished the following information:

On June 21, 1972, at approximately 3:30 PM, source advised he had talked with FRANK YAKOPEC during the preceding two hours. He said YAKOPEC informed him that the Guild Theater had not been his original target on the evening of June 19, 1972. He said he first went to a location known as "Chuck's Bookstore" in downtown San Diego, carrying the bomb in the pocket of a "Pendleton" jacket which he had slung over his shoulder. He said as he was entering the bookstore he began to pull the fuse lighter on the bomb when he was stopped by a San Diego Police Officer, who showed him his badge, telling him he could not come in as the place was being closed down as the result of a raid.

YAKOPEC then indicated he was contemplating doing another bombing within the next few nights with the following targets listed in order of preference:

- The In Crowd on Cuyamaca Road in Santee;
- The Academy Theater on University in San Diego;
- The Pussycat Theater on 4th Avenue in San Diego;
- The Bedroom on University in San Diego.

Source said YAKOPEC has a white Ford Falcon station wagon, about 1963, with license RGC 744, and a 1956 green Chevrolet pickup, license unknown.

Do not serialize this FD 302.
SA CHRISTENSEN resigned 7/6/72
before signing attached.

on 6/21/72 at El Cajon
by SA STEVEN L. CHRISTEN

This document contains neither recommendations nor conclusions of the FBI. It and its contents are not to be distributed outside your agency.

Memorandum

TO : SAC, SAN DIEGO (157-1820)

FROM : SA STEVEN L. CHRISTENSEN

SUBJECT: FRANK YAKOPEC
EM - SAO

DATE: 6/20/72

Informant

On this date ~~informant~~ advised telephonically that he had read of a bombing which had occurred last evening at the Guild Theater on Fifth Ave., San Diego, in the morning "Union", on page B-1. He said upon reading the article he immediately suspected the Subject. Shortly after reading the paper, he received a telephone call from the Subject who asked him if he had read the article and then hinted he had been responsible for the incident.

Subsequently source contacted YAKOPEC in person at which time he described the bombing to source as follows:

The bomb was fashioned from a 1/3 pound HPD primer with a blasting cap, six feet of safety fuse and an old cardboard type pull fuse igniter. YAKOPEC told source he approached the theater through an alley or walkway, removed the screen from an air vent and threw the device through the vent into an area under the stage of the theater. He then walked about one block away and waited for the device to detonate. He indicated that even at that distance he could feel the shock from the explosion. Source said YAKOPEC seemed to be greatly elated with the results of the blast and kept saying, "I did it! I did it!" over and over. Source said YAKOPEC, for as long as he has known him, has had a hatred for business establishments dealing in what he considers to be pornographic entertainment. He said YAKOPEC is aware of the location and the identity of the owners of most of ~~the~~ such ~~&~~ places in the San Diego area and that he has already "cased" approximately half of them.

He said YAKOPEC has available other explosives including one or two more 1/3 pound HPD primers, one or two one pound HPD primers, perhaps a 2 1/2 pound block of C-4 plastic explosive, and a number of blasting caps, all of which are commonly available to individuals associated with "Right Wing" activist groups in the area, and a one hundred foot roll of safety fuse which is not illegal to have.

Source said he does not know of anyone else YAKOPEC



1 - SD 170-286A
1 - SD 157-1820
1 - SD 174-531
SLC/slc
(3)

Buy U.S. Savings Bonds Regularly on the Payroll Savings Plan

170-286A-17

SEARCHED	INDEXED
SERIALIZED	FILED
JUN 22 1972	
FBI - SAN DIEGO	

may have told of his part in the bombing, with the possible exception of his wife who was visiting in Los Angeles at the time, nor did he think there was any particular reason that YAKOPEC would have informed any other person of the incident. Source said this would include other members of the SAO and that this organization was in no way a party to the bombing, which he described as a purely individual act on the part of the Subject caused by his dislike for pornography.

UNITED STATES GOVERNMENT

Memorandum

TO : SAC, SAN DIEGO (157-1820)

DATE: 6/21/72

FROM : SA STEVEN L. CHRISTENSEN

SUBJECT: FRANK YAKOPEC
EM - SAO

On this ~~after~~ date, at approximately 3:30 pm, source advised he had talked with the Subject during the preceding two hours. He said YAKOPEC informed him that the Guild Theater had not been his original target on the evening of 6/19/72. He said he first went to a location known as "Chuck's Bookstore" in downtown San Diego, carrying the bomb in the pocket of a K"Pendleton" jacket which he had slung over his shoulder. He said as he was entering the bookstore he began to pull the fuse lighter on the bomb when he was stopped by a San Diego Police Officer, who showed him his badge, ~~xxxxxx~~ telling him he could not come in as the place was being closed down as the result of a raid.

YAKOPEC then indicated he was contemplating doing another bombing within the next few nights with the following targets listed in ~~xxxxxxxxxxxx~~ order of preference:

The In Crowd on Cuyamaca Road in Santee.

The Academy Theater on University in San Diego.

The Pussycat Theater on 4th. in San Diego.

The Bedroom on University in San Diego.

Source advised he would immediately notify writer of any additional developments.

- 1 - SD 170-286A
- 1 - SD 157-1820
- 1 - SD 174-531
- SLC/slc
- (3)

Source said Yakopec has a white Ford Falcon Station Wagon about 1963, with license RGC 1744, and a 1956 green Chevy pickup, license unknown.

SEARCHED	INDEXED
SERIALIZED	FILED
JUN 22 1972	
FBI - SAN DIEGO	



Buy U.S. Savings Bonds Regularly on the Payroll Savings Plan

22-286-A-174

UNITED STATES GOVERNMENT

Memorandum

TO : SAC (170-286A)

DATE: 7/12/72

FROM : SA Earl M. Petersen

- TE
- CI
- SI
- E
- PC
- PCI
- PSI
- E (Prob)
- E (Ghetto)

SUBJECT: ~~REDACTED~~ INFORMANT

Dates of Contact <p style="text-align: center;">6/30/72</p>	
File #s on which contacted (Use Titles if File #s not available or when CI provides positive information) <u>157-3001 JERRY LYNN DAVIS, EM - SAO</u>	
Purpose and results of contact <input type="checkbox"/> NEGATIVE <input checked="" type="checkbox"/> POSITIVE <input type="checkbox"/> STATISTIC <p>Information contained in the attached FD 302 was obtained confidentially. Informant's name should not be disclosed in report or otherwise until such time as he has testified.</p> <p>Items mentioned in attached FD 302 have been turned over to Detective Ruben Branden as of this date for possible prosecution of JERRY LYNN DAVIS.</p> <p>Source has testified before San Diego County Grand Jury on 7/11 & 12/72 and discovery is expected to reveal his activity as an FBI Informant on about 7/21/72. SDPD has agreed to protect him.</p>	
Has informant shown any indication of emotional instability, unreliability or furnishing false information? <p style="text-align: right;">No</p>	
<input checked="" type="checkbox"/> Informant certified that he has furnished all information obtained by him since last contact.	Coverage Extremist matters
PERSONAL DATA	<p style="text-align: right; font-size: 1.2em;">170-286A-176</p> <div style="border: 1px solid black; padding: 5px; width: fit-content;"> <p>SEARCHED _____ INDEXED _____</p> <p>SERIALIZED _____ FILED _____</p> <p style="text-align: center;">JUL 20 1972</p> <p style="text-align: center;">FBI - SAN DIEGO</p> <p style="text-align: right;">16</p> </div>

- ① - 170-286A
- 1 - 157-3001 (DAVIS)
- 1 - 174-531 (Bombing Guild Theatre)

UNITED STATES GOVERNMENT FEDERAL BUREAU OF INVESTIGATION

Memorandum

Date July 6, 1972

Howard B. Godfrey, 738 Graves, El Cajon, California, made available the following items which he received from JERRY LYNN DAVIS:

- 100 foot roll of time fuze
- 4 1/4 time fuze ignitors
- 4 1/2 pound blocks of TNT (military type)

PC PCI PERMSI E (Pub)
 E (Class)

The above mentioned items were obtained from DAVIS in about November, 1971.

157-3002 JERRY LYNN DAVIS, SA - SAC

Purpose and results of contact

- NEGATIVE
- POSITIVE
- STATISTIC

Information contained in the attached SD 302 was obtained confidentially. Informant's name should not be disclosed in reports or other correspondence unless he has testified.

It was noted in attached SD 302 that Detective Ruben Brenden as of this date has possible prosecution for JERRY LYNN DAVIS.

Source has testified to the fact that when he was arrested on 7/13/72 and was taken to the station to await his arraignment, he was informed in about 7/21/72. SDPD has agreed to protect

On 6/30/72 at El Cajon, California File # SD 157-3001

by SA EARL M. PETERSEN Date dictated 7/6/72

This document contains neither recommendations nor conclusions of the FBI. It is the property of the FBI and is loaned to your agency; it and its contents are not to be distributed outside your agency.

Memorandum

TO : SAC (170-286A)

DATE: 7/12/72

FROM : SA EARL M. PETERSEN

SUBJECT: ~~XXXXXXXXXX~~ Informant

On June 29, 1972, during a meeting between the SDPD, the source and the writer, a discussion was had concerning the possibility of conducting a search of the source's home to give him further protection in connection with information he was furnishing regarding members of the Secret Army Organization. In connection with this discussion, source was asked if he had anything in his home that would make it necessary for the police department to arrest him if his home was searched. He stated that he did have certain items he would like to get rid of before the search. He requested that the writer take the items from him.

On June 30, 1972 he made available the following items:

100 feet of time fuze obtained from JERRY LYNN DAVIS 11/71
 4 1/2 lb blocks of TNT (military type) " " " "
 44 fuze igniters " " " "

The above items were turned over to Detective Reuben Brandon, San Diego Police Department on 7/12/72 for possible evidentiary use in the arrest of JERRY LYNN DAVIS. FD 302 concerning these items has been prepared.

Other explosive items received are:

1 CS Handgrenade (military type) source of item not recalled
 5 Mine fuze, practice obtained from Bill Clay about 1969.
 1 Hand grenade fuze - deactivated

The above mentioned items are stored at the 70th Ord. Det., bunker, Fort Rosecrans, California. [redacted] has advised that these items can be destroyed and a tickler has been set to advise the 70th Ord. Det - Lt. Barnett on 7/24/72 that the items can be destroyed. This will allow time to determine whether the items should be disposed of in any other manner.

① - 170-286A
 1 - 157-3001 (JERRY LYNN DAVIS)
 1 - ~~242~~-174-531 (Yakonec - Guild Theatre Bomb)
 1 - 100-14293 (William Clay)
 1 - 157-3017 (Hoover)

EMP:amp

(5)

170-286A-177

SEARCHED	INDEXED
SERIALIZED	FILED
JUL 13 1972	
FBI - SAN DIEGO	

Buy U.S. Savings Bonds Regularly on the Payroll Savings Plan

The following additional items were obtained and are stored in the firearms vault:

1 - 50 caliber machine gun completely disassembled with barrel cut into two pieces with welding torch. Only about ten inches of the barrel, base section, is with the gun.

Informant would like this gun returned to him if he can obtain authority to own it legally. The gun came off a wrecked World War II airplane that was found in the desert.

One silencer

The silencer was obtained from a garage and was one of a box of about 40. The others were sold in Mexico by gun dealer TOM FORREST. This silencer can be forwarded to the Bureau firearms section.

One sawed off shotgun barrel and stock.

This gun was obtained from GEORGE HOOVER about two months ago. He obtained it from an unidentified individual who got it from his son who intended to use it in a burglary. This weapon can be destroyed.

Two rifle grenade launchers

These were sent to source by one LONNIE LAMBERT, Pandora, Texas. Source would like these returned to him if he leaves the state after testimony as he says these can be legally owned outside California.

(TOM FOREST and LONNIE LAMBERT indexed in 157-3001)

Date prepared

5/10/72

Date received

1/31/72

Received from (name or symbol number)

~~XXXXXXXXXX~~ Informant

Received by

SA STEVEN L. CHRISTENSEN

Method of delivery (check appropriate blocks)

in person

by telephone

by mail

orally

recording device

written by Informant

If orally furnished and reduced to writing by Agent:

Date

Dictated

5/10/72

to

LINDA ELEGINO

Date of Report

1/31/72

Transcribed

Authenticated by Informant

[Signature]

Date(s) of activity

1/30/72

Brief description of activity or material

Info re individuals living at FLEURY

residence, Harbison Canyon

File where original is located if not attached

* INDIVIDUALS DESIGNATED BY AN ASTERISK (*) ONLY ATTENDED A MEETING AND DID NOT ACTIVELY PARTICIPATE. VIOLENCE OR REVOLUTIONARY ACTIVITIES WERE NOT DISCUSSED.

Information recorded on a card index by

on date

Remarks:

157-2815

170-286A-175

157-3017

100-15355

~~INDEX~~: RICHARD FLEURY - 157-3290
GENEVIEVE FLEURY - 157-3289
INDEX - DECKDEXTRAND
to 157-2815

Inf

Block Stamp

170-286A-175

SEARCHED	INDEXED
SERIALIZED	FILED
AUG - 7 1972	
FBI - SAN DIEGO	

[Signature]

JANUARY 31, 1972

BY JEROME

I was talking yesterday with GEORGE HOOVER. He has been spending a great deal of time at the residence of RICHARD and GENEVIEVE FLEURY in Harbison Canyon across the road from the Gunsmoke Ranch.

JERRY LEE BUSCH has also been spending a lot of time there and lives with the FLEURYs part time.

Another individual who also has been spending a considerable amount of time with the FLEURYs is a person whose name is DICK DEXTER or DEXTRAND. DEXTER is a member of the Swallows Nudist Camp which is also located across Harbison Canyon Road from the FLEURYs. DEXTER has apparently been trying to work a way into some of the Right Wing activities which other people at the FLEURYs are involved in and is suspected of being an infiltrator, mostly because of the fact he lives in Ocean Beach.

Jerome 8/2/72

Date prepared

5/10/72

Date received

2/2/72

Received from (name or symbol number)

~~XXXXXXXXXX~~ Informant

Received by

SA STEVEN L. CHRISTENSEN

Method of delivery (check appropriate blocks)

in person by telephone by mail orally recording device written by Informant

If orally furnished and reduced to writing by Agent:

Date

Dictated 5/10/72 to LINDA ELEGINO

Transcribed _____

Authenticated by Informant 8/2/72 G.P.

Date of Report

2/2/72

Date(s) of activity

2/1/72

Brief description of activity or material

CONTACT WITH GENE BOSARTH. VIGILANTE
MEETING AT LAKESIDE. EXPECTED VISIT OF
CY ANDERSON TO SAN DIEGO.

File where original is located if not attached

* INDIVIDUALS DESIGNATED BY AN ASTERISK (*) ONLY ATTENDED A MEETING AND DID NOT ACTIVELY PARTICIPATE. VIOLENCE OR REVOLUTIONARY ACTIVITIES WERE NOT DISCUSSED.

Information recorded on a card index by _____ on date _____

Remarks:

157-2815

170-286A-179

157-2933

100-15450

157-3001

1 - Seattle
(157-CY ANDERSON)

INDEX: GENE BOSARTH to
157-2815

Information pertaining to the
Republican National Convention
was appropriately handled at
the time it was received.

Block Stamp

170-286A-179

SEARCHED	INDEXED
SERIALIZED	FILED
AUG - 2 1972	
FBI - SAN DIEGO	

P. [Signature]

FEBRUARY 2, 1972

BY JEROME

Yesterday, I accompanied STAN MC DADE to keep an appointment with GENE BOSARTH, the San Diego State College student who has indicated a willingness to furnish information about New Left oriented activities at San Diego State College to the SAO. BOSARTH claimed to have written letters to Governor REAGAN regarding the PETER BOHMER situation at State College requesting that some action be taken against BOHMER. MC DADE backed off a little when BOSARTH mentioned he had been contacted by the local office of the California Bureau of Criminal Investigation and Identification and even went so far as to suggest that we might do the same thing.

Later in the day, I learned from both MC DADE and SAM DAVIS that there was a type of vigilante meeting in Lakeside several days ago of local individuals and groups. It appears this meeting was held to discuss and plan out actions to be taken to keep hippies and other undesirable individuals out of the Lakeside area during the Republican National Convention in San Diego this summer.

It was brought to my attention that the semi-annual Yuma Gun Show will be held on the 25th, 26th, and 27th of February. I was told that CY ANDERSON will be coming down from Seattle to attend this gun show and will come to San Diego several days in advance to take care of some business here.

Jerome 8/2/72

Date prepared

5/10/72

Date received

2/4/72

Received from (name or symbol number)

~~XXXXXXXXXX~~ Informant

Received by

SA STEVEN L. CHRISTENSEN

Method of delivery (check appropriate blocks)

in person

by telephone

by mail

orally

recording device

written by Informant

If orally furnished and reduced to writing by Agent:

Date

Dictated 5/10/72 to LINDA ELEGINO

Transcribed _____

Authenticated by Informant

8/2/72

Date of Report

2/4/72

Date(s) of activity

2/3/72

Brief description of activity or material

NSWPP meeting at San Diego. Info re

MICKEY BURTON WAKEFIELD

File where original is located if not attached

* INDIVIDUALS DESIGNATED BY AN ASTERISK (*) ONLY ATTENDED A MEETING AND DID NOT ACTIVELY PARTICIPATE. VIOLENCE OR REVOLUTIONARY ACTIVITIES WERE NOT DISCUSSED.

Information recorded on a card index by _____ on date _____

Remarks:

157-28

170-286A-180

100-14301

157-338 (VICTOR WALTON)

157-2810 (MICKEY BURTON WAKEFIELD)

157-3017

2 - Los Angeles

INDEX:

○ "Captain K." to 157-28

ES

Block Stamp

170-286A-180

SEARCHED	INDEXED
SERIALIZED	FILED
AUG - 2 1972	
FBI - SAN DIEGO	

Pete [Signature]

FEBRUARY 4, 1972

BY JEROME

PAUL RUPLINGER told me yesterday he was at an NSWPP meeting last Wednesday night at the San Diego unit headquarters. He said about 20 people were in attendance and had come to hear a speaker from Los Angeles, known as "Captain K" tell about recent confrontations by the NSWPP and the Jewish Defense League at Los Angeles. He said VIC WALTON was one of those people he recognized as being in attendance at this meeting.

I was also told yesterday by GEORGE HOOVER that an NSWPP member named WAKEFIELD had been booted out of the organization for engaging in unauthorized activities such as throwing bricks through the windows of various New Left establishments.

Jerome 8/2/72

SAC (157-3138) (P)

9/7/72

SA EARL M. PETERSEN

VICTOR WALTON
EM - NSW: P

On 9/6/72, HOWARD BARRY GODFREY, ~~Informant~~
advised that subject has never been a member or associated
with the Secret Army Organization in any way known to him.

① - 170-286A
EMP:emp

(3)
8

170-286A-195

~~157-3138-56~~

SEARCHED	INDEXED
SERIALIZED	FILED
SEP 7 1972	
FBI - SAN DIEGO	
	W

SAC (157-2305)(P)

9/7/72

SA EARL M. PETERSEN

CHARLES WILLIAM CLAY, Jr.
EM - MINUTEMEN

On 9/6/72, HOWARD BARRY GODFREY, ^{Informant} ~~_____~~ advised that subject has married again but he does not know the name of his wife.

Clay carries an M-2 carbine behind the back seat of his truck. He had a Beretta .22 cal. pistol with silencer two months ago. He allegedly purchased this weapon from ROGER WILLIS at the Gunsmoke Ranch.

Detective RUBIEN BRANDON, SDPD advised.

CLAY SHOULD BE CONSIDERED ARMED AND DANGEROUS

1 170-286A

EMP:emp

(3)

170-286A-196

SEARCHED	INDEXED
SERIALIZED	FILED
SEP 7 1972	
FBI-SAN DIEGO	

W

SAC (157-28)(P)

9/7/72

SA EARL M. PETERSEN

NSWPP
EM

Informant

On 8/28/72, HOWARD BARRY GODFREY, [redacted] was asked how to become a member of subject group. He replied that the best way would be to attend one of the white power rallies, act enthusiastic, talk to people; act very impressed with GERALD LEE SMITH. If possible meet and talk to SMITH and tell him what a great job he is doing and be very impressed with him. SMITH goes for this.

① - 170-286A
EMP:emp
(3)

170-286A-197

SEARCHED	INDEXED
SERIALIZED	FILED
SEP 7 1972	
FBI-SAN DIEGO	

102

Memorandum

DATE: 9/20/72

TO : SAC (157-3228)(P)

FROM : SA EARL M. PETERSEN

SUBJECT: PAUL ERWIN RUPLINGER
EM

Informant

On 9/12/72, HOWARD BARRY GODFREY, ~~████████████████████~~ advised that he had been contacted by relatives in Hawaii who advised him that subject was recently in Hawaii and had contacted a mutual friend of his. GODFREY speculated that possibly subject might be attempting to determine where he is presently living as there have been rumors that he was living in Hawaii.

On 9/19/72, Godfrey advised that PAUL RUPLINGER and his son PETER RUPLINGER will testify for the defense in the trial of WILLIAM FRANCIS YAKOPEC not in progress in San Diego County Superior Court.

In view of the new rules concerning inclusion of subjects in the ADEX, this file should be carefully reviewed and if subject does not qualify, the file should be closed.

EMP:emp ① - 170-286A
(3)

170-286A-198

SEARCHED	INDEXED
SERIALIZED	FILED
SEP 20 1972	
FBI - SAN DIEGO	

10



Buy U.S. Savings Bonds Regularly on the Payroll Savings Plan

SAC (157-2305) (P)

9/7/72

SA EARL M. PETERSEN

CHARLES WILLIAM CLAY, Jr.
EM - MINUTEMEN

On 9/6/72, HOWARD BARRY GODFREY, ~~INFORMANT~~ advised that subject has married again but he does not know the name of his wife.

Clay carries an M-2 carbine behind the back seat of his truck. He had a Beretta .22 cal. pistol with silencer two months ago. He allegedly purchased this weapon from ROGER WILLIS at the Gunsmoke Ranch.

Detective RUBIEN BRANDON, SDPD advised.

CLAY SHOULD BE CONSIDERED ARMED AND DANGEROUS

① - 170-286A
EMP:emp

(3)



170-286A-199

SEARCHED	INDEXED
SERIALIZED	FILED
SEP 7 1972	
FBI-SAN DIEGO	

SAC (157-1816)(P)

9/20/72

SA EARL M. PETERSEN

JAMES EVAN POTO, aka
EM - SAO

INFORMANT

On 9/6/72, HOWARD BARRY GODFREY, ~~_____~~ advised that subject is an SAO member who helped JERRY LYNN DAVIS stash some weapons at Cuyamaca. He is in Davis's group in the SAO and is the type that might try to revenge the arrest of DAVIS.

POTO is occasionally armed and should be considered dangerous.

CONSIDER ARMED AND DANGEROUS

EMP:emp
(3)

① - 170-286A
1 - 157-3001 (DAVIS)

75-286A-200

SEARCHED	INDEXED
SERIALIZED	FILED
SEP 1972	
FBI - SAN DIEGO	

12

2720101/11/11/11

TO : SAC (157-1926) (P)

DATE: 9/20/72

FROM : SA EAPL N. PETERSEN

SUBJECT: JAMES EVAN POTO, aka
EM - SAO

In Formant

On 9/6/72, HOWARD BARRY GODFREY, ~~in formant~~ advised that subject is an SAO member who helped JERRY LYNN DAVIS stash some weapons at Cuyamaca. He is in Davis's group in the SAO and is the type that might try to revenge the arrest of DAVIS.

POTO is occasionally armed and should be considered dangerous

CONSIDER ARMED AND DANGEROUS

EMP:emp

(3)
g

- 1 - 170-286A
- 1 - 157-3001 (DAVIS)

170-2864-206
RET

SEARCHED	INDEXED
SERIALIZED	FILED
OCT 5 1972	
FBI - SAN DIEGO	
<i>lu</i>	



Buy U.S. Savings Bonds Regularly on the Payroll Savings Plan

SAC 157-2769)(P)

9/7/72

SA EARL M. PETERSEN

EDWARD ANDREWS
EM -

On 9/1/72, HOWARD BARRY GODFREY, **INFORMANT**
[REDACTED] advised that he has not seen subject for some time and believes that he is now in Arkansas. He does not know if his middle initial is S.

ANDREWS is about 67 years old, is retired, slender, 145 pounds, 5' 8"-9" tall.

① - 170-286A

EMP:emp
(3)

170-286A-207

SEARCHED	INDEXED
SERIALIZED	FILED
SEP 7 1972	
FBI-SAN DIEGO	

SAC (157-2769)(P)

10/10/72

SA EARL M. PETERSEN

CHANGED
EDWARD SPENCER ANDREWS, JR.
EM - MM * SAO

INFORMANT

On October 10, 1972, HOWARD BARRY GODFREY ~~INFORMANT~~ looked at driver's license number H129296 for EDWARD SPENCER ANDREWS, Jr., 1809 Calla St., Imperial Beach, California 92032 and stated that this license contains a photograph of EDWARD ANDREWS who GODFREY had previously furnished information on. He is the ANDREWS, GODFREY said had gone to Arkansas.

GODFREY stated that the photograph contained on the driver's license is a good likeness of EDWARD ANDREWS.

① - 170-286A

EMP:emp

(3)

g

710-286A-208

SEARCHED	INDEXED
SERIALIZED	FILED
OCT 11 1972	
FBI-SAN DIEGO	

LA

SAC (157-3143) (P)

9/7/72

SA EARL M. PETERSEN

CHRIS SKINNER

INFORMANT

On 9/6/72, HOWARD BARRY GODFREY, [REDACTED] advised that he has no new information re subject.

(Information furnished 7/31/72 is in 157-3143-3)

① - 170-286A no cpy to 170-286A)

EMP:emp

(3)

g

170-286A-210

SEARCHED

SEARCHED	INDEXED
SERIALIZED	FILED
SEP 7 1972	
FBI-SAN DIEGO	

[Signature]

11/15/72

SAC (157-2815) (P)

SA EARL H. PETERSEN

SECRET ARMY ORGANIZATION
EM

INFORMANT

On 11/14/72, HOWARD HARRY GODFREY, advised that on about 11/12/72, RICHARD FLEURY had severely beaten his wife GENEVIEVE. She was so severely injured that her cheek bone was pushed up into her eye and her nose was broken in two places. She was taken to the hospital and surgery was necessary, including going into the top of her head to correct nerve damage.

Source stated that Mrs. FLEURY has been fooling around with GEORGE MITCHELL HOOVER and has been visiting him in jail on a weekly basis. HOOVER had requested that she bring him a map of Mexico. Source speculated that Mrs FLEURY and HOOVER might intend to flee to Mexico if he is ever released on bond. Source stated that it is his understanding that the SDCSO intends to arrest FLEURY on charges of felonious assault.

- 1 - 157-3017 (Hoover)
- 1 - 157-3289 (Genevieve Fleury)
- 1 - 157-3290 (Richard Fleury)
- ① - 170-286A

EMP:emp

(5)

170-286A-212

SEARCHED	INDEXED
SERIALIZED	FILED
NOV 16 1972	
FBI - SAN DIEGO	

11

SAC (157-3282)(P)

9/7/72

SA EARL M. PETERSEN

RICHARD MILLER
EM -

In FORMANT

On 9/1/72, HOWARD BARRY GODFREY, formerly advised that subject is not affiliated with the Secret Army Organization in any way.

Subject was a friend of JERRY LYNN DAVIS who was a leader in the SAO.

① - 170-286A
EMP:emp
(B)
g

170-286A-218

SEARCHED _____ INDEXED _____
SERIALIZED *2/2* FILED _____
SEP 7 1972
FBI - SAN DIEGO
rk

Date prepared

1/15/73

Date received

1/12/73

Received from (name or symbol number)

FN FORM HT

Received by

Earl M. Belcher

Method of delivery (check appropriate blocks)

in person

by telephone

by mail

orally

recording device

written by Informant

If orally furnished and reduced to writing by Agent:

Date

Dictated _____ to _____

Transcribed _____

Authenticated by Informant 1/9/73

Date of Report

1/9/73

Date(s) of activity

1/4/73

1/7/73

Brief description of activity or material

G Smith Speech SDSC

Radio program re SD + FBI

File where original is located if not attached

170-572A

* INDIVIDUALS DESIGNATED BY AN ASTERISK (*) ONLY ATTENDED A MEETING AND DID NOT ACTIVELY PARTICIPATE. VIOLENCE OR REVOLUTIONARY ACTIVITIES WERE NOT DISCUSSED.

Information recorded on a card index by _____ on date _____

Remarks:

1-170-572A-44

1-157-201 (Gerald Smith)

1-157-28 (NSWOB)

1-157-2815 (SAO)

① 170-286A

EMB: g
(5)

A

Block Stamp

170-286A-22

SEARCHED	INDEXED
SERIALIZED	FILED
JAN 17 1973	
FBI - SAN DIEGO	

1/17

~~Would Tend to Identify~~

January 9, 1973

SUBJECT: Activities of Gerald L. Smith.

On Thursday night, January 4, 1973 Gerald Smith spoke to an evening class at San Diego State College. He does not remember the name of the professor in charge of the class but says he teaches advertising and public relations classes. Knowing what I do about San Diego State College, this means that the class is probably held in the Business Administration and Mathematics Building, one of the newest structures on campus. Gerald also stated that the professor had dark curly hair and sported a beard. The topic of the speech was the organizational structure of the National Socialist White Peoples Party. Gerald states that he was well received by the class and that there was no harrassment whatsoever. In fact, an invitation has been extended to Joseph Tommasi via Smith to make a similar appearance before the same class.

On Sunday, January 7, 1973 Gene Cubbison of the Independent Newspaper made a two-hour broadcast over radio station KSDO-San Diego. The broadcast included discussions of the Secret Army Organization, the FBI, Howard Barry Godfrey and Gerald L. Smith. Ray Wilson notified Smith that the program was in progress but Smith heard only about the last half hour of it. In this broadcast, Cubbison was highly critical of the SAC and FBI. Cubbison said that Peter Bohmer was being unjustly persecuted by the authorities. He criticized the FBI for not cracking down on the SAO long before it did. He challenged Barry Godfrey to call in and defend his position. A similar challenge was also issued to Gerald Smith but Godfrey seemed to be the one they really tried to bait. This program lasted from 9:30 to 11:30 a.m. During the program, at least one person did call in and this person was extremely critical of Smith. Smith believes this broadcast is merely an attempt on Cubbison's part to sell more newspapers and to dredge up old right-wing bogie men for the Marxists to throw rocks at.

Cubbison was also quite sarcastic toward Judge Froelich. He flatly stated that the reason the judge delayed the sentencing of Bohmer was because he was afraid to sentence him. He felt that the presence of the large Leftist crowd in the court room intimidated Judge Froelich. Gerald Smith also feels this way about it.

That's about all for now. Will be in touch when more develops.

Sincerely,

~~Would Tend to Identify~~

FEDERAL BUREAU OF INVESTIGATION

He stated that he is acquainted with Gene [redacted] 126 Charlotte Place, Colorado, California. Date 11/27/72
associated with an organization called the "LBO" etc. etc.

PAUL ERWIN RUPLINGER was interviewed at his home at 4567 Massachusetts Street, San Diego, California. He was advised of the identity of the interviewing agents and the purpose of the interview. He furnished the following information:

He denied ever having been a member of the Secret Army Organization (SAO) but has known HOWARD GODFREY for four or five years. He said he was surprised when he learned that GODFREY had been an informant for the FBI for the entire period that he has known him. He once met JERRY LYNN DAVIS through GODFREY. DAVIS was introduced to him as "SAM." He was aware that GODFREY and SAM were involved with the SAO. He denied knowing SY ANDERSON of Seattle, Washington or that he was involved in furnishing guns, ammunition and explosives to SAO members.

RUPLINGER has from time to time given sums of money to GODFREY for use in financing bulletins printed and distributed by the SAO. He furnished this money because of an interest in "survival." At one time he was shown a poster printed on 8 1/2" x 11" paper containing a resume of information extracted from newspapers regarding President NIXON. Later when this poster was printed and distributed, he was surprised to see that it was printed on 8 1/2" x 13" paper, contained a photograph of President NIXON and indicated that he was wanted.

RUPLINGER said his only interest in the SAO was the organization's contribution to "survival." He said he has always had an interest in this matter and has written many pamphlets over the years dealing with this subject. He was at one time a "Survival Consultant." His latest effort in the field of survival was to mastermind an organization called "Virtues in America." He said he had help in setting up the organization but that it failed because of lack of interest. The organization was only interested in pushing survival activity. He would like to reorganize this organization. If he is able to do so he will advise the FBI of his progress and will furnish copies of any literature distributed by him.

On 11/22/72 at San Diego, California File # 170-286A-223
357-3229
SAs DWIGHT G. CARRIMSON and
EARL H. PETERSON:emp Date dictated 11/27/72

This document contains neither recommendations nor conclusions of the FBI. It is the property of the FBI and is loaned to your agency; it and its contents are not to be distributed outside your agency.

He stated that he is acquainted with General WILLIAM LENLY, 1536 Glorietta Place, Coronado, California. He met him in connection with an organization called the "Liberty Amendment Committee." This was a movement started by one WILLIS STONE to change or completely eliminate the 16th Amendment to the Constitution. This would eliminate the income tax in the United States. Another goal of the organization was to get the U. S. Government out of all the businesses it runs at a loss.

RUPLINGER stated that he has never been a member of the Minutemen Organization. He met TROY HAUGHTON, the leader of this group twice in 1965 or 1966. The first time he met HAUGHTON, he got into an argument with him when he told him that the Minutemen Organization was inconsistent. He denied knowing anything about the disappearance of HAUGHTON.

RUPLINGER stated that he is not involved in any activity against the best interest of the United States and does not intend to get involved in such activity. He said he does not have in his possession explosives or illegal weapons.

[Faded text, likely bleed-through from the reverse side of the page]

[Faded text, likely bleed-through from the reverse side of the page]

SAC, SAN DIEGO (157-2815)

7/13/73

SA DWIGHT G. GARRETSON

SECRET ARMY ORGANIZATION
EM

Review of pertinent files reveals the following information:

Information regarding shooting of PAULA THARP by GEORGE MITCHELL HOOVER was originally furnished by SA STEVEN LEE CHRISTENSEN by HOWARD BARRY GODFREY on 1/12/72. The shooting had occurred on 1/6/72. See memo of SA CHRISTENSEN dated 1/13/72 and San Diego Nitel to Bureau 1/13/73. (170-286-90 and 157-3017-20).

The information regarding this shooting was furnished to CAPTAIN KENNETH O'BRIEN, SDPD by SAs CHRISTENSEN and EARL M. PETERSEN on 1/13/73. See San Diego Nitel to Bureau 1/14/73. (170-286-88 and 157-3017-19).

2 - 157-2815
1 - 157-3017
① - 170-286

(4)
DGG:

170-281-A-225

SEARCHED	INDEXED
SERIALIZED	FILED
JUL 1 1973	
FBI—SAN DIEGO	

SSC Request 1/20/76
Item 2 (Re: Howard Berry Godfrey)
Volume III

Retain

Date prepared

3/23/70

Date received

3/5/70

Received from (name or symbol number)

SD 1155-R

INFORMANT

Received by

SA Steven L. Christensen

Method of delivery (check appropriate blocks)

in person by telephone by mail orally recording device written by Informant

If orally furnished and reduced to writing by Agent:

Date

Dictated

3/11/70

to

Date of Report

3/5/70

Transcribed

3/12+13/70

Authenticated by Informant

3/18/70

Date(s) of activity

3/5/70

Brief description of activity or material

Names + addresses allegedly taken from files of SD Free Door to Liberation by Minutemen Org.

File where original is located if not attached

134-914A

* INDIVIDUALS DESIGNATED BY AN ASTERISK (*) ONLY ATTENDED MEETING AND DID NOT ACTIVELY PARTICIPATE. VIOLENCE OR REVOLUTIONARY ACTIVITIES WERE NOT DISCUSSED

100-14948 (Free Door)

~~134-914A~~ 170-286A - 1

100-12461 (Minutemen - p. 1 of report only)

Index: all names in report underline.

170-286A-1
Block Stamp

SEARCHED	INDEXED
SERIALIZED	FILED
MAR 31 1970	
FBI - SAN DIEGO	

Listed below is information which was allegedly obtained by the Minutemen Organization from the files of the underground newspaper known as the "San Diego Free Door to Liberation".

Names and Addresses from a small telephone number and address directory:

APCO Printing, Inc.
2141 Bixby Road
Lakewood, California 90712
Telephone 213-426-7123

ROBERT J. BERTON
1355 Front Street
Suite 200
San Diego, California 92101
Telephone 239-3331

BOLAND, BERNIE And GAY
790 North Yucca
Rialto, California 92376
Telephone 714-TR5-3447

Mrs. J. G. BINGHAM
25615 Norbonne Avenue
Apartment Number 10
Lomita, California 90717
Telephone 213-326-8017

BEVERLY EDWARDS (March 28, 1969)
Lakeside
Telephone 443-3496

DEAN MITTEN
398 4th Street
S.B.
telephone 885-1514
320 Laurel (JERRY SIRSEN)
San Diego
Telephone 234-3161

BALDIVA DAVILA
995 Broadway
El Cajon
Telephone 442-4066

Jerome

BETTY and JOE DOWNS
4929 North Wolcott-3A
Chicago, Illinois, 60640

Fast Print Company (Close Saturday)
5520 University
Telephone 583-9591

LON GUILD
5192 La Dorna
San Diego 92115
Telephone 583-2511

Mrs. L. C. HERSCHLER
445 Argyle Drive
Alexandria, Virginia 22305
telephone 703-548-9673

SARA HERSCHLER
1862 Woodland Avenue
Columbus, Ohio 43219
Telephone 614-253-5751

HILDA
Telephone 443-2072

LOUIS HERSCHLER
94-923 Makaloha Street
Waitahu, Hawaii 96797

CAROL HERSCHLER
236 Porter Hall
Miami University
Oxford, Ohio 45056
Telephone 513-529-7197

JIM HAYDEN
3760 Adams Avenue
San Diego 92116
Telephone 222-8609

SAMUEL HECSEH
Residence telephone 224-8297
Business Telephone 234-3441

J

2

Private MAX HERSCHLER
RA 11708980
CMRX5
Box 18079
Ft. Rucker, Alabama 36360
3990 South Hwy,
85-87 Lot 40
Colorado Springs, Colorado 80909
Telephone 303-392-5036

SUEY JAY (BILL JAY)
3137 National Avenue
Number 10
San Diego 92113
Telephone 235-0142

JUDY (typist)
4432 Campus

VIRGINIA BRIGGES
S.P. Valley
Telephone 469-0357

MIKE MILLIGAN
Telephone 460-2515

BENTE MEYERS
P.O. Box 1676
Vista
Telephone 724-5703

YVONNE MITSINGAS
1949 31st
Telephone 233-0725

ELEANOR MARTIN
1028 Redwood Avenue
Apartment 28
El Cajon, California 92021
Telephone 442-5092

PENNY BATES
Telephone 448-7189

AL RICKEL
1056 Grand Avenue
P.B.
Telephone 488-1879

PWJC-IRVIN FALK
1145 4th Avenue
92101
Telephone 232-4311

Pacific Distributors
232-3284

Paine, Mable, Jackson
and Curtis
1145 4th Avenue
San Diego 92101
Telephone 232-4311

Forward; LYNN RANICO
CAROLYN RANY
8007 Eastern Drive
Number 302
Silver Springs, Maryland

LAMBERT Optical Company
143 North High
Columbus 15, Ohio

LOIS O'NEAL
(worker for THATCHER)
North on 69th from University (South)
2nd house on right past Donn Way
Telephone 286-8297

LUCY EDWARDS
2776 54th right on Nutmeg, kind of u-turn,
right again to dirt road to left,
house sets back
Telephone 263-3831

ABBIE
Telephone 442-6658

ELEANOR MARTIN
8288 Orchard Avenue
Apartment G
La Mesa, California
Telephone 465-7470
4940 Comanche
Apartment Number 1

WILLIAM RICHARDSON, Landlord
3630 Fir
San Diego 92104
Telephone 234-1492

Mrs. BONITA RAMSEY
3349 43rd
San Diego
Telephone 281-0527

RHODA RISDELL
637 Forward Street
459-7995

JEN T. TRADER (Nut)
(Met at Nexus Open House)
6869 Park Ridge Boulevard
San Diego
Telephone 465-5243

STEPHANY SALKELA
(Museum of Man)
304 West Ivy
Apartment 204
LaMonda Apartments
Telephone 232-2554

THERESA THOMPSON
5715 Androse Place
Apartment Number 4
San Diego
Telephone 286-4819

SYNANON (new)
3955 Fourth Avenue
San Diego 92103
Telephone 297-1171

Teaspoon
3493 University
92104
Telephone 282-8431

JOCELYN THOMAS
(Lady at Nexus)
5015 Cliff Place
Telephone 283-1452

GARY THATCHER
Telephone 442-6668

VPI (Closed Saturday)
2113 El Cajon Boulevard
Telephone 297-4223

Vanderpool
P.O. Box 531
Del Mar
Telephone 755-3845
Telephone 755-3111

The following names and addresses and other information were contained in a mechanical telephone number and address directory:

Abortion Counseling Service
1369 B Street
92101
233-4515

Academy Theater
284-1000

A.B.L.E.
520 E Street
Room 502
San Diego
234-3158
232-6621

AA
239-1365

ACLU
Post Office Box 6233
San Diego 92106
223-3863

APCO Publishing Corporation
2141 Bixby Road
Lakewood, California 90712
Attention: WILLIAM B. ANDREWS
426-7123

Arlington Times (Riverside County Publishing Company)
1094 Hale Avenue
Riverside, California
689-1122
(PETE PARSONS)

ROBERT JAMES BERTON
1355 Front Street
Suite 200
San Diego 92101
Business phone: 239-3331
Residence phone: 463-6380

7

J

Boland.
790 Yucca
Rialto, California 92376
875-3447

Crisis
3004 Imperial
239-0325

Citizens Interracial Committee
5th floor of the Robinson Building
5th and E
239-0871

The Candy Company
7711 El Cajon Boulevard
469-9376

Coast Dispatch at Encinitas
(JIM BARROTT)
459-1213
459-6543

GARY WAYNE CRANE
3965 Paula Street
La Mesa, California
460-6924
465-9891

Cosmic Center - Greig
488-5551

Butch Cornelius
2727 De Anza Road
San Diego 92109
274-0670

LON CURTIS
291-1786

JEANETTE DUFTON
Dean's Photo
Lemon Grove
239-5450
459-3707
460-7675

DARE (BRUCE)
2968 Nutmeg
232-1159
283-5186

DEAN WITTER
JERRY SIRSEN
320 Laurel
San Diego
234-3161

YVONNE DA TORRE
3536 Fairmount
282-4777

Draft Counseling
J. STUART INNERST
5840 Camino De La Costa
La Jolla 92037
459-3174

Draft
FRED GORDON
755-4654

San Diego Draft College
DEBBIE
276-8866

ELLIE
465-7470

DENNIS EWALD
4675 $\frac{1}{2}$ Voltaire
222-6196
home: 1858 Chatsworth
224-4633

IRWIN FALK
1145 4th Avenue
232-4311

Fast Print
5520 University
583-9591

Folk Arts
291-1786

SAMUEL HECSEH
234-3441
224-8297

JIM HAYDEN
4560 Wilson
San Diego 92116
284-5565

HERB JOSEPH
4904 Clairemont
273-8772

SUEY JAY (BILL JAY)
3137 National Avenue #10
San Diego 92113
235-0142

KPRI
645 Ash Street
San Diego, California 92101
239-1385

~~Kairos~~
624 Upas
295-1569

~~M. LEVENS~~
4258 Middlesex Drive
San Diego 16

~~ETTA LINTON~~
264-5134

PATTIE LYONS
7447 Cayhill Drive
San Diego
262-2562

STEVE MONTIJO
469-7631

BERNARD MARCUS
291-2363

Message Information Center
232-6621

YVONNE MITSINGAS
1649 West Clinton Avenue
Fresno 93705

CLEM MARKS
239-2941

MIKE MILLIGAN
583-3251

ELEANORE MARTIN
460-0596

WILLIAM MAGUIRE
9523 Abbeywood
Santee
448-0675

Reverend RICHARD MCKENNA
1924 Island
232-6621

MIKE MC HUGH
9247 Cariton Circle
Spring Valley, California 92077
466-3149

WALTER MC CLURE
5002 Santa Fe
272-3170

New Adult Community
232-6621

Nexus
340 South 3rd
El Cajon 92021

AM Generation
Lakeside
443-3519

Plebian
La Jolla
454-1888

Paisley Pelican
Newport Avenue
223-6901

Planned Parenthood Association
House of Hospitality
B.P. 234-7593

Peace and Freedom contact
ALTA BERTRAM
465-2838

PAGNI
3605 30th Street
291-3020

AE RICKEL
1056 Grand Avenue
488-1879

Pacific Distribution
Mr. LEVISH
621 4th
San Diego
232-3284

RICK PHELPS
1844 Washington Place
232-1743
466-6061

Riverside Co. Pbl. Co.
Post Office Box 8368
0V9-1122

WILLIAM RICHARDSON
3630 Fir
San Diego 92104
234-1492

BOB RINEHART
443-1539

HARRY RIDER
460-9423

Revolution
JOAN JENSEN
1787 Titus Street
San Diego 92110
296-4625

DICK RUSSELL
459-4439
454-7658

STOVOLD
753-8709

Experimental College
286-6575

Stock Quotation
239-6181

STAN SOHLER
35061 Beach Road
Capistrano Beach, California 92624

SFL
Post Office Box 0105
College Grove Center
San Diego 92115

RAY SCHWARTZ
4382 Roselind
La Mesa
465-6544

GENE SPARKMAN
488-4077

Street Journal
3605 5th Avenue
233-4454

T M
1806 Erie
276-2217

GARY THATCHER
411 South Magnolia
El Cajon 92022
442-6668

The Indicator
UCSD
453-1077

VOY (RONNIE WEINS)
235-8945

Vanderpool
Karmacy
3825 5th Avenue
291-1798

~~ROBERT WORMAN~~
D.W. 398 West 4th Street
S.B. 92041
889-0741
885-1515

HOWARD WRAY
~~460-4400~~

~~STEVE ZARK~~
4288 Harlinson
La Mesa 92041
461-1185

Youth Lifeline
233-1333

The following names, addresses, and other information contained in a small cardboard file box with headings as used in the filing system:

People

MIKE MC HUGH
nudist (knows RINEHARTs)
9247 Carthay Circle
Spring Valley 92077
466-3149

JERRY A. HEATH

6484 Thornwood

San Diego

278-1602

(interested in putting out own magazine to express self. Can pay writer or (?) to help him. Said he would help us in any way he can. Would deliver paste up to Los Angeles.)

PETER DEEMER

Publicity Representative from Kairos

Rancho Santa Fe

Wishing Well Hotel

756-1123

DICK TARQUINIO

7250 Artillery

San Diego 92111

(Journalism instructor at Mesa College)

JOHNNIE and MARIE

Poway

1-748-3368

TOM HEPP

Grossmont College Librarian

(likes people, has worked with Synanon)

8800 Grossmont College Drive

El Cajon

H. VANDERPOOL

Underground Publications

Post Office Box 531

Del Mar, California

755-3845

JAMES PAGNI

291-3020

(puts on dances at the Concourse)

DICK MC KENNA

239-5766

239-2119

JOHN WATANABE

President, SDS

283-0994

JACK FORREY,
274-4677

GLOVER DAVIS
SDS, teacher, poet
residence: 447-0024

Outlets

BARON ROLAND
Peace of Creation
209 West Indian School Road
Scottsdale, Arizona

Head 'n Soul
4040 Mission Boulevard

BEVERLY GEARHART
2219 East 1st Street
N. C.

Jim's Books
508 Mission
Oceanside, California 92054
722-5662

Surfboard Hugo
3076 Carlsbad Boulevard
Carlsbad

Larry's (?) Liquor
(on Grant between Broadway and Escondido Boulevard)
Escondido, California

JIM MURPHY
SDS
UCSD
755-1900

Mr. MARE
UCSD Book Store
La Jolla 92037

Printers

BILL MC CUTCHEON Printers

Encinitas

753-6543

459-4158

Trade Printing Company

3122 Reynard Way

San Diego

AAA Printers

Second Street

San Bernardino, California

LV8-0708

BOB BONAJO

Organizations

Planned Parenthood

295-2223

Council for Social Action

San Diego

Peace and Freedom Party

5728 El Cajon

583-8943

Citizens Interracial Committee

239-0871

Message Information Center at Episcopal Community Services

555 19th Street

Catholic Cardijn Center

Mexican-American Youth Association

Tuesday the Ninth Committee

UCSD

Underground Press

The Teaspoon
4465 Arizona Street
San Diego 92116
298-2195;
3493 University
282-8431

JERRY SHEATH
(to publish San Diego underground, new)

KEN COWAN
494-5286
(Laguna)

833-5548
(UC Irvine)

836-6689
(Peace Center)

Fluxus West
KEN FRIEDMAN
1600 Holloway Avenue
San Francisco 94132
(do not give out San Francisco address);
6361 Elmhurst Drive
San Diego 92120

Middle Eye
3550 Duffy
Muscoy (also north side of King Street,
west of Mt. Vernon)

The Underground Press

MIKE MILLIGAN, Managing Editor.

Editorial Board:

MARLIN AYOTTE

DOUG KITT

SCOTT JOHNSON

General Coordinator:

ELAIN AYOTTE

Distribution:

KENNY LEVENSON

DON TRAXLER

Photo Work:

Hidrotic Productions.

Staff

CHRIS ENGLISH - SDS
1144 Marline
El Cajon
444-0836

SYLVIA SHAPIRO
CSA
Gadfly
6953 Eldridge
San Diego 92120
583-1626

GAYLE INGLORIAN M.
427-3969

SUNNY ENDONIA D.
422-6221

ROGER STOVOLD, Photographer
1420 Neptune
Leucadia 92024

BOB GAINES, SDS
4673 Wilson Avenue
San Diego 92116
283-9435
(interested in reporting, interviewing, etc.)

LOU CURTIS
Folk Arts
Krome Kazoo
3753 India Street
San Diego 92103

MIKE SCHEEL
4466 49th Street
San Diego
(art and write-up on local rock groups)

PATRICIA TVEDT, typist
465-7470

JILL ZARNOWITZ
276-2782

SHIRLEY WESTON
276-4320

BETTY BUCK
~~273-4335~~

LOUISE OFFINGER
~~277-6446~~

SUE RADCLIFFE
~~298-3433~~

STEVE MITCHELL
~~453-4732~~

DON TONGUEWIEL
~~(art) 296-3848~~

PEGGY WILSON
~~283-0994~~

JEANETTE DUTTON
1330 31st
239-5450

~~DARLENE FUJINA~~
~~CURT BOUTERSE (really fine lettering)~~
~~298-8641~~

DONNA DAVIS
706 Nantasket Court
488-0806

/ JO ELLEN (DOUG TUTHILL's friend)

~~BECKY GALDEANO~~
~~(does the hippidrome posters)~~

~~DAN LONGUEUIEL~~
1737 Fort Stockton
296-3448

~~GEORGE ELGIN~~
phtographer
3802 58th Street
San Diego 92115
286-9257

ELEANOR MARTIN
8288 Orchard
La Mesa 92041
465-7470
(not good for anything, but love)

TOM HEEKIN
5951 Eldergardens
San Diego 92120
583-9372
(reporting, writing, record review)

~~SIDNEY ELLIOTT~~ (SDS art work)
9265 Virginian Lane
La Mesa
465-1778

BLAIR ALLEN
5056 Woodyard
La Mesa
466-1730

STEVE ZARK
4288 Harbinson
La Mesa 92041
463-1920

BUD SONKA
5061 63rd
582-6534
(reporter, etc., or whatever)

STEVEN HICKS
4724 Austin Drive
San Diego 92115
582-0133
(to write Army experience)

MARV HUMPHREY
1435 B Street
San Diego
233-3705

~~RICHARD GONSALVES~~
1938 Erie Street
San Diego 92110
(attends City College - journalism)

~~STEVE FERREIRA~~
50 Monte Vista, Apartment F-6
Chula Vista, California
426-0473

~~VAHN SHAMOTH~~
262-9674
(Foreign journalist, experienced)

~~JIM SCHEETZ~~
(journalism graduate, editorials on local scenes)

~~STAN OLIVER~~
761 Sawtelle Street
San Diego, California
465-8784

~~MIKAEL STEEGER~~

~~JIM BAUMANN~~
2043 1/2 Grand Avenue
Pacific Beach 92109
274-8289
(interested in writing, history editor)

~~LEONARD DAVID~~
5048 Mt. Frissell Drive
San Diego, California 92117
278-0427
(Social Science major - some photography)

~~GLORIA TIERNEY~~
525 8th Street
Coronado, California 92118
1-435-3531
(attends Southwestern College)

~~LEE KELLISON (RAYMOND SCOTT)~~

~~MIKE LAHEY, SDS~~
6222 Madeline, Apt, 192
San Diego
286-4746
(art and writing)

JANA MENESEE

8461 Hudson Drive
San Diego, California 92119
469-5481
(ads, selling)

JERRY MURRAY

4262 Cleveland Avenue
San Diego 92103
295-0480
(writing)

AL PICKEL

1056 Grand Avenue
Pacific Beach
1-488-1879
(interested in circulation)

RAY HALLER

4534 30th Street
(art, also illustrations to order)

DIANE REED

223-6482
(calendar)

BOB RINEHART

9906 River Street
Lakeside, California 92040
443-1539
(cartoonist)

EVELINA PONCE

5376 Penny Place
San Diego, California 92115
286-2465
(writing, music review)

ROBERT E. STRAIN

8058 University Place
La Mesa, California 92041
463-4065

JOE FERRARESE

3742 7th Avenue
San Diego, California 92103
296-1250
(writing, theater review)

PAUL J. ROSS
2608 Shelter Island Drive
#1 Beggar's Row

STEVE GIFFORD
(rock review)

JOE CARUSO
1010 16th Street
San Diego
298-4051

STEPHEN W. CAREY, IV
c/o Pacific Air Lines
1805 West Fifth Street
Oxnard, California 93030
(Haight-Ashbury contact)

LEA BRAMER
San Carlos
469-9149
(writing, copywriting, reporting)

HARRY RYMER, JR.
4735 Newport Avenue
Ocean Beach 92107
(illustrate stores, etc.)

HAL B. OGUSS
6029 Adams Avenue
582-6999

GREG MASON
6141 Dalhart
La Mesa 92041
469-6333
(artist and carrier)

VAUGHN LOUTHEN
7033 Boulevard Drive, #2
La Mesa
460-5640
(art work)

ALLISON ALLFREY
San Diego 92103
297-0155
(photography, "opinion type" reporting)

ERIC BAECHT
582-7916
(movie review)

MARY PRIGMORE
3104 Freeman Street
Point Loma, San Diego, 92106
222-3492
(reporting, record review)

JIM HAYDEN
Ocean Beach
3670 Adams Avenue
San Diego 92116
284-5565
(photography)

JAMIE
(artist, ads, etc.)

MICHAEL THOMPSON
4122 Nabal Drive
La Mesa, California
469-3985
(photographer)

DONALD KAY
2125 Reed Avenue
San Diego (Pacific Beach)
235-2322
(artist - psychadelic)

MARCOS FRYE
1846 Island Avenue
#31
232-9652
(writing, reporter)

DWIGHT SMITH
1676 Vann Court
El Cajon
442-5427
(circulation)

JON WOKULUK
5525 Hardy Avenue
San Diego 92115
286-3187
(artist, cartoonist)

ROY SHORT
Box 3785
San Diego 92103
296-1709
(writes legal column)

MARK ROEDER
4888 Jessie
La Mesa
(art work, circulation)

STEBANI HORTON
(Iron Horseman)
3838 49th Street
San Diego 92105

BUTCH CORNELIUS
912 Beryl Street
San Diego, California 92109
(cartoonist)

BRIAN D. SMITH
3377 Central
Spring Valley
460-9998

RICH PHELPS
1844 Washington Place
San Diego 92103
232-1743
466-6061
(advertising)

JIM BAUMANN
2043 $\frac{1}{2}$ Grand
Pacific Beach
274-8289

JAN ECKLER
8452 Mt. Vernon
Lemon Grove
466-3409
(SDS art major)

MANUEL MARTINEZ
4915 Jumano
San Diego
(reporting, Mesa College)

MICHAEL FLANIGAN
2608 Shelter Island Drive

HORST GATZ
1043 Loring Street
San Diego
(SDS senior)
(writes humorous, satirical, political column)

DREW ALTSTATT
1372 Opai
Pacific Beach
1-488-3570

JACK GARVER
3641 Birdie Drive
La Mesa
469-1732
(story on Judge Crawford and haircut)

DAVE FLANAGAN
(reporter)

STEVE MONTIJO
8539 Chevy Chase
La Mesa
469-7631
291-3160

SUE WILSON
2102 Balboa
Apartment #1
Jahoda (landlady) 273-3340

Paid Subscribers

Hollygate Ranch
8835 Harbison Canyon
El Cajon, California 92021

SUSAN HOLMES
311 Sawtelle Avenue
San Diego, California 92114

FRED HORN
4330 Witherby Street
San Diego, California 92103

GUY IRWIN
4320 Yale
San Diego, California

KEM IRWIN
4938 Bogart
Baldwin Park, California 91706

E. P. JAFFARIAN
Route 3, Box 600
Escondido, California 92025

JIM and JOAN
PO Box 575
San Diego, California 92112

E. J. JOHNSON
PO Box 10521
San Diego, California 92110

KIRBY JOHNSON
1319 Missouri Street
San Diego, California 92109

RICHARD JOKO
1781 South Valentine Way
Denver, Colorado 80228

JON JORGESON
PO Box 10079
San Diego, California 92110

BILL JUSTICE
6945 Saranac Street
San Diego, California 92115

BARBARA KAHN
3710 Yosemite
San Diego, California 92109

Dr. ROBERT G. KAPLAN
104 Quince Street
San Diego, California 92103

CHARLES KASSLER
4916 Del Mar Avenue
San Diego, California 92107

LOUIS S. KATZ
c/o Gostin & Katz
1540 6th Avenue
San Diego, California 92101

F. A. KASTELIC
7787 Jamacha
San Diego, California 92114

ARNOLD KAUFMAN
1809 Linwood Street
San Diego, California 92110

DALE KIRKENDALL
Route 3, Box 552E
Escondido, California 92025

MIKE KIRKHORN
Milwaukee Journal
333 West State Street
Milwaukee, Wisconsin 53201

BRUCE KIRWAN
3762 $\frac{1}{2}$ Villa Terrace
San Diego, California 92104

KARL C. KOHL
6641 Kelly
San Diego, California 92111

JOSEPH W. KRAATZ
PO Box 1286
Vista, California 92083

MIKE JUTTNAUER
6536 Cascade Street
San Diego, California 92122

JOSEPH KWOCK
2506 Puaena Place
Honolulu, Hawaii 96822

JUNE LA FLEUR
1214 South 14th Street
Escanaba, Michigan 49829

JACK LAMONICA
PO Box 165
Santee, California 92071

J. W. LEASURE
1112 Bush Street
San Diego, California 92103

CLINTON LE JEUNE
5010 Niagara
San Diego, California 92107

CHRISSEY LESIK
3963 Alicia Drive
San Diego, California 92107

JUDY LEVENTHAL
1455 North Los Ruges
Pasadena, California 91104

Library, Serials
Wisconsin State University
River Falls, Wisconsin 54022

BRITTA LIEN
2315 Presidio
San Diego, California 92103

PAUL H. LINDBERG
4734 Hamilton Street
San Diego, California 92116

RUSS LINTON
~~2524~~ 44th Street
San Diego, California 92105

The Local Swinger
4186 Elm Avenue
Suite 2
Long Beach, California 90807

JENNY LONERGAN
3675 Roselawn Avenue
San Diego, California 92105

Luce Press Clippings
PO Box 1903
Mesa, Arizona 85201

GIDGET MADSEN
~~4391~~ Mentone Street
San Diego, California 92107

DONALD E. MAKOSKY
PO Box 642
San Diego, California 92112

JERRY MALUGEON
8311 Keokuk Avenue
Canoga Park, California 91306

ED L. MANGELSEN
5153 Mission Boulevard
San Diego, California 92109

LEO MANUEL
Mesa College
San Diego, California 92111

R. & N. MARIANI
1108 Concord
Apartment A
El Cajon, California 92021

JANET MATTES
212 Shumway Street
Lena, Illinois 61048

R. C. MAVING, JR.
3036 Nile Street
San Diego, California 92104

JOHN D. MAYBEE
4695 Bancroft
Apartment #5
San Diego, California 92116

C. MC AULIFFE
Mesa College
San Diego, California 92111

Mr. and Mrs. W. MC CLURE
PO Box 6116
San Diego, California 92106

WAYNE MC CRACKEN
3663 Hondo Street
San Diego, California 92105

D. C. MC DONALD
9011 Garland Avenue
Silver Springs, Maryland 20901

T. R. MC GINLEY
Route 1, Box 779
Escondido, California 92025

LEE MC GOUGH
13604 Los Olivos
Poway, California 92064

BOB MELUCCI
4330 Austin Drive
San Diego, California 92115

ERMA MILLER
2038 Reed Avenue
San Diego, California 92109

EVE MILLER
1360 Dale Street
San Diego, California 92102

Mrs. WAYNE MONSEES
7785 East Roseland Drive
La Jolla, California 92037

JOHN D. MOORE
2740 Roosevelt Street
Carlsbad, California 92008

JEAN MCRICK
3537 Ocean Front Walk
San Diego, California 92109

RAYMOND MOSS
4438 Chio Street
#9
San Diego, California 92116

A. J. MUNKER
PO Box 161
Boulder City, Nevada 89005

Mrs. NELSON T. MURRAY
4847 Hart Drive
San Diego, California 92116

New Adult Community
1924 Island Avenue
San Diego, California 92102

R. E. NICHOLS
Box 2385
San Diego, California 92112

ED NOEL
612 I Avenue
San Diego, California 92118

Northeast Ad. Service
1230 Arch Street
Philadelphia, Pennsylvania 19107

Dr. and JOYCE NOWER
4110 Gateside Road
La Mesa, California 92041

Oklahoma Department of Libraries
109 State Capitol
Oklahoma City, Oklahoma 73105

VERNON K. OLIVER
PO Box 12022
San Diego, California 92112

JOYCE OPESMAN
618 South Lehigh Drive
Tucson, Arizona 85710

RICHARD PARCEL
4301 70th Street
La Mesa, California 92041

EMILY PARK
1012 Lincoln Avenue
San Diego, California 92103

MIKE PARKER
402 63rd
San Diego, California 92102

TED PHILLIPS
4502 Maryland, Apt. #3
San Diego, California 92116

GRACIA PICK
5483 Redding Road
San Diego, California 92115

BILL POULSON
1604 Enfield Street
Spring Valley, California 92077

R. PRICE
PO Box 1511
La Jolla, California 92037

BRUCE QUIGLEY
5805 La Jolla Boulevard
La Jolla, California 92037

Ravenhurst Enterprises
709 Milo Terrace
Los Angeles, California 90042

LYLE A. REISCHE
PO Box 678
Alpine, California 92001

H. D. REPLEY
2398 Highview Lane
Spring Valley, California 92077

Residet
538 Oaklawn
Chula Vista, California 92010

R. RICHARDSON
HOLA #32

Richelmann
6278 Acorn
San Diego, California . 92115

FORREST ROBERTSON
1318 West 227th, #D
Torrance, California 90501

TRUDY ROBIDEAU
1317 Walnut Street
Berkeley, California 94709

JACK ROBISON
3455 Stillar Drive
San Diego, California 92111

J. E. RUSSELL
PO Box 981
El Cajon, California 92022

RICHARD RUSSELL
PO Box 1759
La Jolla, California 92037

FRANK SAIZ
7478 Hyatt Street
San Diego, California 92111

GEORGE B. SCHICK
607 North Cedros
Solana Beach, California 92705

ROBERT N. SCHIAUG
3705 Sioux Avenue
San Diego, California 92117

E. J. SCHOENHALLE
PO Box 6936
Burbank, California 91505

WAYNE SCHUPP
8010 Anders Circle
La Mesa, California 92041

J. R. SCHWARTZ
51921 Deborah Lane
Newport Beach, California 92660

RAY SCHWARTZ
4921 Muir Avenue
San Diego, California 92107

R. B. SCHWITZGEBEL
3721 Nassau Drive
San Diego, California 92115

DUANE V. SCOTT
120 Willow Road
San Ysidro, California 92073

F. W. SEIDLE
38209 Channel Drive
Cathedral City, California 92234

CONRAD SELLE
Box 36
Cutler, Illinois 62238

Serials Department
Kent State University Library
Kent, Ohio 44240

JUNE SERMONS
4558 North Avenue
San Diego, California 92116

SANDEE SEVERE
Bob 414
Spanaway, Washington

SFL, Inc.
PO Box 7856
Long Beach, California 90807

RICHARD SHANNOR
6919 Maury Drive
San Diego, California 92119

Mrs. ANGELA SHEFCIK
7030 Arillo Street
San Diego, California 92111

Sherman's
PO Box 23122
San Diego, California 92123

R. E. SINNEM
739 Island Court
San Diego, California 92109

A. P. SMITH
4309 Hamilton
Hyattsville, Maryland 20781

D. L. SMITH
PO Box 951
La Jolla, California 92038

J. I. SMITH
10321 Happy Lane
Santee, California 92071

STAN SOHLER
Box 2187
Idyllwild, California 92349

RICHARD M. STALL
1558 West 2nd Street
Los Angeles, California 90028

PAUL STEIN
Box 3321
San Diego, California 92103

BOB STOREY
4444 68th Street
San Diego, California 92115

ERIC SVENSON
PO Box 288
Alpine, California 92001

LEONARD SHENKAN
846 Missouri (P.B.)
San Diego, California 92109

CHARLES SHIMEK
1401 Mariposa
San Diego, California 92114

HERMAN SLATER
118 Court Street
Brooklyn, New York 11201

DONALD H. SMITH
3341 India
San Diego, California 92103

GERALD SMITH
7975 Canton Drive
Lemon Grove, California 92045

MICHAEL G. SMITH
4771 68th Street
San Diego, California 92115

W. SOLLE
2750 Figueroa
San Diego, California 92109

CAROL STANTON
6455 La Jolla Boulevard, #216
La Jolla, California 92037

JAMES STEVENSON
5238 Imperial
San Diego, California 92114

Suffolk Coop. Library System
Box 187
Bellport, New York 11713

CAROLYN SYMONDS
3939 Newmark Avenue
San Bernardino, California 92405

Mrs. A. TAYLOR
301 East 29th Street
National City, California 92050

~~DIMITRI TCHELISTCHEFF~~
~~PO Box 1082~~
Ensenada, B.C., Mexico

JEAN TRADER
6869 Park Ridge Blvd.
San Diego, California 92120

Unusual Sales Company
Rt. 2, Box 582
Thermal, California 92274

~~JACK VOPE~~
945 20th Street
San Diego, California 92102

~~Mr. WALSH~~
Board of Supervisors
214 Co. Admin. Cntr.
San Diego, California 92101

~~JAMES A. WARD~~
1511 Minden Drive
San Diego, California 92111

~~NORMAN WATSON~~
7957 Cornell
Taylor, Michigan 48180

~~ANNA E. WEBBER~~
3412 Fairmont
San Diego, California 92105

~~VICTOR WEINER~~
1830 Upas, Apartment #11
San Diego, California 92103

~~JOHN H. TAYLOR~~
1229 Via Barranca
La Jolla, California 92037

Town House Coiffures
8043 La Mesa Boulevard
La Mesa, California 92041

EDWARD F. TUBBS
5033 South 12th Street
Arlington, Virginia 22204

~~KURT K. URBASCHEK~~
3222 Vancouver Avenue
San Diego, California 92104

~~DONALD L. WALLER~~
2821 North Arroyo Drive
San Diego, California 92103

~~KAISER C. WANSIK~~
PO Box 223
Chula Vista, California 92012

~~KATHERINE WARD~~
4444 Long Branch Avenue
San Diego, California 92107

CHARLES WATTS
PO Box 2101
San Diego, California 92101

~~WILLIAM P. WEEKS~~
605 South Nardos Avenue
Solana Beach, California 92075

~~G. WEISS~~
I.Q. Trends
PO Box 12160
San Diego, California 92112

S. WEISSMAN
7516 Parkway Drive
La Mesa, California 92041

MELANIE WILLIS
10386 Rancho Road
La Mesa, California 92041

WILLIAM F. WITHROW
212 South 2nd Avenue
SP 15
El Cajon, California 92021

GREG VETTER
8859 Gardena Road
Lakeside, California 92080

ELIZABETH P. YOUNG
4229 5th Avenue
San Diego, California 92103

DENNIS ZEMINSKY
2451 1st Avenue
San Diego, California 92101

M. WILLIAMSON
8690 Mulvaney Drive
San Diego, California 92119

HIRAM WINTER
Dot Records
1507 North Vine
Hollywood, California 90028

RAY B. WOODMANSEE
1324 Gregory
San Diego, California 92102

EDWIN YOUNG
PO Box 23402
San Diego, California 92123

TERRY YULE
733 Verona Court
San Diego, California 92109

Subscribers' "Dead" File

Peninsula Observer
180 University Avenue
Palo Alto, California 94301

KARL C. KOHL
222 East Quintard
Chula Vista, California 92010

BOB BEECHER
Box 1351
Oceanside, California 92054

New Adult Community
520 E Street
San Diego, California 92101

LOU HICKEY
2825 A Street
San Diego, California 92101

SIMS
7460 Girard, Suite 16
San Diego, La Jolla, California

Poppy Records
212 East 30th Street
New York, New York

BRITTA LIEN
4202 Quapaw
San Diego, California 92117

LONNIE WIENS
4069- $\frac{1}{2}$ Texas
San Diego, California 92104

J. M. WARD
825 A Avenue
Coronado, California 92118

SUSAN TIDEMAN
1351 Ocean Avenue
Del Mar, California 92014

ANALEE STEWARD
5002 Longbranch Avenue
San Diego, California 92107

ROBERT L. SHEEHAN
900 West Broadway
Plainview, New York 55964

TAMSIN S. SCHULTE
1240 Melba Road
Encinitas, California 92024

RONNIE PAYNE
81940 Camelot Way
Indio, California 92201

MILTON W. NODACKER
641 Lincoln Street
Calexico, California 92231

ROBERT MITTEER
Vallecito Stage Station
Julian, California 92036

JON JORGESON
PO Box 10079
San Diego, California 92110

CAROLYN SYMONDS
3939 Newmark Avenue
San Bernardino, California 92405

Mrs. A. WHITE
5068 35th Street
San Diego, California 92116

MITCHELL E. TIMIN
2344 Curlew Street
San Diego, California 92101

E. L. SUMRALL
940 Monserate Avenue
Chula Vista, California 92011

PIERRE STEPHENSON
8284 La Mesa Boulevard
La Mesa, California 92041

TIM SCOTT
5120 Orcutt
San Diego, California 92120

DOUG RUBINO
6565 Glenroy Street
San Diego, California 92120

BARBARA PAINE
738 Balboa Court
San Diego, California 92109

TOM NICKEL
730 Silvergate Avenue
San Diego, California 92106

JOE MILLER
9243 Shadow Hill Road
Santee, California 92071

STEVE MC DANIEL
2409 56th Street
San Diego, California 92105

STEWART MARKHAM
5484 55th, Apt. 1
San Diego, California 92115

ROBERT A. JURAN
501 North Rossmore
Los Angeles, California 90004

JULIUS JOHNSON
3148 1/2 40th Street
San Diego, California 92105

DENNIS HILL
3979 Alabama
San Diego, California 92104

FANTASIA
3022 Cedar Street
San Diego, California 92102

GEORGE C. CHILVERS
3667 Mississippi Street
San Diego, California 92104

RICHARD BRUNS
1229 De Haro Street
San Francisco, California 94107

Dr. D. R. ARCHER
411 Thorn Street
San Diego, California 92103

WALLACE MAUCH
4525 70th Street
La Mesa, California 92041

JAMES A. KANE
PO Box 336
Alpine, California 92001

DONALD E. JORDAN
1611 Highland Avenue
National City, California 92050

MIKE IRWIN
660 South Fairview Avenue
Goleta, California 93926

Mr. and Mrs. W. HANSEN
8925 Lamar Street
Spring Valley, California 92077

R. J. ENTRINGER
3040 Browning Street
San Diego, California 92106

CIC
1501 6th Avenue
San Diego, California 92101

L. P. BROWN
4375 Ampudia
San Diego, California 92103

PAULETTE AMBERSON
207 South Johnson
Charles City, Iowa 50616

PAPERS GIVEN FREE TO INDIVIDUALS

Lowell Blankfort
429 Third Ave.
Chula Vista, CA 92010

Mrs. Joseph Cole
4155 50th
San Diego, CA 92105

Butch Cornelius
912 Beryl St.
San Diego, CA 92109

Gail Cornyn
2511-1/2 Speedway
Venice, CA 90291

Betty Downs
4929 Wolcott
Chicago, IL 60640

Max Herschler
3990 S. Hwy. 85-87
Lot #40
Colorado Springs, CO 80909

Herschler
1862 Woodland Ave.
Columbus, OH 43219

Don Jackson
325 Jeffrey St.
Bakersfield, CA 93305

Karen, KPRI
645 Ash St.
San Diego, CA 92101

Bert Lazerow
School of Law
University of San Diego
San Diego, CA 92110

Lyle Marsh
325-54th St., SP. 23
San Diego, CA 92114

Harriet Painter
P.O. Box 508
Little River, CA 95456

Bob Rinehart
P.O. Box 194
Lakeside, CA 92040

Eugene Schoenfeld
P.O. Box 680
Tiburon, CA 94920

Richard Stoneman
76 Riverside Drive
New York, NY

Ernest Twiss
8800 Grossmont College
El Cajon, CA 92020

B. F. Allison
P.O. Box 369
Santee, CA 92071

Tony Anderson
P.O. Box 17152
San Diego, CA 92117

Antioch College
Yellow Springs, OH 45387

R. G. Barron
P.O. Box 17432
San Diego, CA 92117

Richard Bass
612 Brooklyn
Oakland, CA 94606

Mrs. Allen Bassett
10565 Fuerte Dr.
La Mesa, CA 92041

Westey Beckman
1800 Madrid Rd.
Las Cruces, NM 88001

R. E. Beecher
P.O.Box 421
Fallbrook, CA 92028

Mike Beldon
P.O.Box 17262
San Diego, CA 92117

Karu Beltran
219 C
Coronado, CA 92118

Kay Bergman
5082 San Aquario Drive
San Diego, CA 92109

L. Boileau
P.O.Box 1294
Escondido, CA 92025

Helen Bolotin
2063 E. Lincoln Ave.
Escondido, CA 92025

Jud Bowers
6230 Federal
San Diego, CA 92114

Mildred Brewer
975 Bush, Apt. 506
San Francisco, CA 94109

E. F. Brighty
1009 Olive Ave.
Vista, CA 92083

Robert Brown
3068 Adams
San Diego, CA 92116

Larry Brown
3187 Ashford
San Diego, CA 92111

Lloyd Brown
3319 Gopher Canyon
Vista, CA 92083

Stephan Budau
4508 Terrace Dr. Apt. 7
San Diego, CA 92116

Jesse Burke
4345 Middlesex Dr.
San Diego, CA 92116

Chris Burnam
1141 Balour Drive
Encinitas, CA 92025

Joseph S. Burns
1328 Ynez Pl.
Coronado, CA 92118

J. Burns
5650 Hardy Ave.
San Diego, CA 92115

Lou Byerly
606 E. Washington
Ann Arbor, MI 46108

Ray Byron
2323 Elm
Imperial Beach, CA 92032

Stephen W. Carey, 4th
1/2 Hotel Lyric
140 Jones St.
San Francisco, CA 94102

Jan Carlson
3832-47th
San Diego, CA 92105

Norman Casserly
P.O.Box 8182
Washington Station
San Diego, CA 92102

Estelle Chacon
914 Candlelight Place
La Jolla, CA 92037

Dan Chevan, Jr.
4575 Georgia
San Diego, CA 92116

43

J

Sam Cohen
19211 Tracey
Detroit, MI 48235

Preston Coleman
645 West Street
San Diego, CA 92113

Mike Collier
2616 Camulos St.
San Diego, CA 92107

Wm. F. Copeland
1217 Washington Ave.
Burlington, WA 98233

Gwen Cook
Box 578
Ellsworth, WI 54011

D. H. Couwenberg
Box 9544
San Diego, CA 92109

David R. Craig, Jr.
8800 Gardena Rd.
Lakeside, CA 92040

Charlene Cyders
2241 Holly Ave.
Escondido, CA 92025

Israel David
5113 Raleigh St.
Hollywood, CA 90004
Dec. 23, 1969,
Kibbutz Ashot
Yaacov Mevchap
Israel

Valida Davila
995 Broadway
El Cajon, CA 92021

Dave Davis
706 Nantasket Court
San Diego, CA 92109

George Dayton
2840 E. Tyler
Long Beach, CA 90810

Lloyd E. Dellinger
235 Mt. View Rd.
El Cajon, CA 92021

Rev. Michael E. DeVore
2770 Glebe Rd.
Lemon Grove, CA 92045

Mike Difani
4821 A St.
San Diego, CA 92102

Dr. D. D. Dorfman
309 Melrose Ave.
Iowa City, IA 52240
Dec. 23,
314 Magowan
Iowa City, IA 52240

Margaret Dudley
2515 Sweetwater Rd. Sp.
Space 48
Spring Valley, CA 92077

Richard M. Dutton
6612 Avenida de la Reina
La Jolla, CA 92037

James D. Easton
Box 1819
La Jolla, CA 92037

James Edmunds
3407 Cowley Way #3
San Diego, CA 92117

Gary J. Emblem
6499 Montezuma
San Diego, CA 92115

Jere Erickson
Box 3071
La Mesa, CA 92041

3
44

J

Evening Tribune Saldana
P.O.Box 191
San Diego, CA 92041

John M. Feagans
410 L Street
Chula Vista, CA 92011

Albert F. Fertig
5083 Conrad Ave.
San Diego, CA 92117

Mike Fry
2320 Palermo Drive
San Diego, CA 92106

Harvy Furgatch
3247 Mission Village Dr.
San Diego, CA 92123

F. C. Gates
525 Seabright Lane
Solana Beach, CA 92075

M. Gizoni
4230 42nd St.
San Diego, CA 92105

Robert Glenn
3901 Ocean Front Walk
San Diego, CA 92109

D. W. Gondeck
4201 Hamilton
San Diego, CA 92104

Elizabeth Greenlee
3477 Ruffin Rd., 2-F
San Diego, CA 92123

Jean Gregg
3640 Sepulveda Blvd.
Los Angeles, CA 90034

Bob Greve
22800 Republic Ave. Apt. B
Riverside, CA 92508

Jon Gullede
1835 Guy St.
San Diego, CA 92110

Bob Guthrie
4536 Baxter Ct.
San Diego, CA 92117

Mr. & Mrs. J. Halpin
13975 Humo Drive
Poway, CA 92064

Hamill
1059 University
San Diego, CA 92103

Herbieaug Hammer
Box 34845
Los Angeles, CA 90034

Dick Hammes
1520 Cliffdale Rd.
El Cajon, CA 92020

James E. Harmon
720 Heber Ave.
Calexico, CA 92231

Vernon L. Harris
1713 Evergreen St.
San Diego, CA 92106

Sharon Harrison
626 Maria Ave.
Spring Valley, CA 92077

Samuel P. Hays
1421 Wightman St.
Pittsburgh, PA 15217

Charles J. Heim
Box 326
Oceanside, CA 92054

Russell Hethrington
7735 Mission Gorge Rd.
Santee, CA 92071

45

J

Warren Heyer
1255 Wren
San Diego, CA 92114

Lou Hickey
1119 Madison St., Apt. 4
Hollywood, CA 90029

C. Hills
Box 483
San Marcos, CA. 92069

Ronald F. Hinz
Box 443
Del Mar, CA 92014

Phil Hobbes
8815 Kenwood Dr.
Spring Valley, CA 92077

Robert W. Holden
6995 Galewood St.
San Diego, CA 92120

46
~~5~~

J

PAPERS GIVEN FREE TO ORGANIZATIONS AND BUSINESSES

~~Academy Theater~~
3721 University Ave.,
San Diego, CA 92105

ACLU
323 W. 5th
Los Angeles, CA 90013

Abortion Counseling
P. O. Box 9199
San Diego, CA 92109

Actors' Quarter Theater
480 Elm St.
San Diego, CA 92101

Roger Ahrens
Grey Advertising
777 Third Ave.
New York, NY 10017

Argo
Box 11965, UCSB
Santa Barbara, CA 93107

Ann Arbor Argus
725 N. Univ. #7
Ann Arbor, MI 48104

Armstrong
P. O. Box 1186
Torrance, CA 90505

SDSC AZTEC
San Diego State College
5401 College Ave.
San Diego, CA 92115

Bell Records
1776 Broadway
New York, NY 10019

Berkeley Barb
Box 5017
Berkeley, CA 94715

Berkeley Tribe
P.O. Box 9043
Berkeley, CA 94709

The Bond
Rm 633, 156 5th Ave.
New York, NY 10010

Broadside
P.O. Box 65
Cambridge, MA 02139

Burning River News
% The Outpost
13037 Euclid Ave.
E. Cleveland, OH 44112

~~California Theater~~
4th & C
San Diego, CA 92101

Campus Media, Inc.
165 W. 46th St.
New York, NY 10036

Capri Theatre
3812 Park Blvd.
San Diego, CA 92103

CBS Records
51 W. 52nd St.
New York, NY 10019

Cinerama Theater
5889 University Ave.
San Diego, CA 92115

Cinema 21
1440 Hotel Circle
San Diego, CA 92110

Cinema Theater
5500 Grossmont Center
LaMesa, CA 92041

Ed & Sue Cobbs
1631 Harbison Cyn. Rd.
El Cajon, CA 92021

Loren Coleman
Chess Records
320 E. 21st St.
Chicago, IL 60616

College Theater
63rd & El Cajon Blvd.
San Diego, CA 92115

Columbia Records
51 W. 52nd St.
New York, NY 10019

NMA & M Conscience
Box 3BS
Las Cruces, NM 88001

Cooperman, etc., Inc.
421 5th Ave.
Pelham, NY 10803

Stan Cornyn
Warner Reprise
4000 Warner Blvd.
Burbank, CA 91505

CPR
9124 Sunset Blvd.
Los Angeles, CA 90069

Dallas Notes
Box 7140
Dallas, TX 75209

Distant Drummer
420 South Street
Philadelphia, PA 19147

Dot Records
1507 N. Vine St.
Hollywood, CA 90028

Doubleday & Co.
277 Park Ave.
New York, NY 10017

Druid Free Press
2345 E. Speedway
Tucson, AZ 85719

Kevin Eggars
RCA/Poppy
1133 Ave. of the Americas
New York, NY 10036

Elektra Records
1855 Broadway
New York, NY 10023

Epic Records
51 West 52 Street
New York, NY 10019

EXTRA
Box 2426
Providence, RI 02906

The Fifth Estate
1107 West Warren
Detroit, MI 48201

Fine Arts
1818 Garnet Street
San Diego, CA 92109

Fontana Records
35 E. Wacker Drive
Chicago, IL 60601

Fox Loma Theatre
5130 Rosécrans
San Diego, CA 92106

Joe Gannon
Bizarre Records
5455 Wilshire Blvd.
Los Angeles, CA 90036

Bob Garcia
A & M Records
1416 La Brea
Los Angeles, CA 90028

48

5

Jon Gordon
Tetragrammaton Records
359 N. Canyon Drive
Beverly Hills, CA 90210

Don Graham
Blue Thumb
427 N. Canon Drive
Beverly Hills, CA 90210

Great Speckled Bird
Box 7946, Sta. C
Atlanta, GA 30309
Jan 11, 1970:
P.O.Box 54495
Atlanta, GA 30308

Grossmont Col. GRIFFIN
Grossmont College
8800 Grossmont Col. Dr.
El Cajon, CA 92020

Grove Press, Inc.
80 University Place
New York, NY 10003

Hartford's Other Voice
Box 2424
Bishops Plaza Sta.
W. Hartford, CT 06117

Bill Harvey
Elektra
1855 Broadway
New York, NY 10023

Heathcote School of
Living Center
Freeland, MD 21053

Helix
3128 Harvard
Seattle, Wash. 98102

Mr. Hendler
Liberty
6920 Sunset Lane
Los Angeles, CA 90028

Heterodoxical Voice
Newark Free Comm., Inc.
P.O.Box 24
Newark, DE 19711

The Image
4514 Fountain
Hollywood, CA 90029

Indianapolis Free Press
Box 88253
Indianapolis, IN

UCSD INDICATOR
UCSD
Gilman & Miramar
La Jolla, CA 92037

Kaleidoscope
1876 N. Sheffield
Chicago, IL 60614

KPRI
645 Ash St.
San Diego, CA 92101

Barry Kramer
Creem
3729 Cass Ave.
Detroit, MI 48201

KSTT, Inc.
1111 East River Dr.
Davenport, IA 52803

Kudzu
P.O.Box 22502
Jackson, MS 39205

La Jolla Library
1006 Wall
La Jolla, CA 92037

La Mesa County Library
8055 University Ave.
La Mesa, CA 92041

49

J

Stu Langer
Dot Records
1507 N. Vine St.
Los Angeles, CA 90028

La' Raza
P.O.Box 31004
Los Angeles, CA 90031

Dennis Lavinthal
ABC/Dunhill
449 S. Beverly Drive
Beverly Hills, CA 90212

Left Speak Out
Box 3510, Glen Sta.
Peoria, IL 61614

Lemon Grove County Library
7735 Pacific
Lemon Grove, CA 92041

LNS
160 Claremont Ave.
New York, NY 10027

Liberation
339 Lafayette St.
New York, NY 10012

Light & Flower Co.
Box 238, Village Sta.
New York, NY 10014

In Arcane Logos
Box 2433
New Orleans, LA 70116

Love
P.O.Box 5057
Reno, NV 89502

Wm. Lucas--RCA
1133 Ave. of the Americas
New York, NY

Miami Free Press
3305 Grand Ave.
Coconut Grove, FL 33139

Mercury Records
35 E. Wacker Dr.
Chicago, IL 60601

Evotner of Voices
Box 429
Amherst, MA 01002

Nickel Review
Box 65 University Sta.
Syracuse, NY 13210

New Left Notes
1608 W. Madison
Chicago, IL 60612

News From Nowhere
Box 501
DeKalb, IL 60115

Moia Express
Box 2342
New Orleans, LA 70116

North Carolina Anvil
P.O.Box 1148
Durham, NC 27702

Northwest Passage
2129 Yew St. Rd.
Bellingham, WA 98225

NT & B
Suite 1713
5455 Wilshire Blvd.
Los Angeles, CA 90036

Ode Records
51 W. 52nd St.
New York, NY 10019

Other Scenes
P.O.Box 8, Village Sta.
New York, NY 10014

Open Forum
323 W. 5th St.
Los Angeles, CA 90013

50

15

James C. Pagni Co.
3605 30th St.
San Diego, CA 92104

P. & F News
619 S. Bonnie Brae
Los Angeles, CA 90057

Peace & Freedom Party
1727 W. Washington Blvd.
Venice, CA 90291

Phillips Records
35 E. Wacker Drive
Chicago, IL 60601

Poppy Records
1133 Ave. of the Americas
New York, NY 10036

PROBE
Box 12629, UCSB
Santa Barbara, CA 93107

Pterodactyl
Box 81, Grinnell College
Grinnell, IA 50112

Pussycat Theatres
5445 Sunset Blvd.
Hollywood, CA 90024

Radical Research Center
Carleton College
Northfield, MN 55057

Rancho Drive-In
Federal & Euclid
San Diego, CA 92102

Rat
201 East 4th St.
New York, NY 10009

RCA Victor Record
6363 Sunset Blvd.
Hollywood, CA 90028

Rebirth
P.O.Box 729
Phoenix, AZ 85002

Renaissance
Box 11668, UCSB
Santa Barbara, CA 93107

Resistance Press
P.O.Box 592
Chicago, IL 60690

Richard Gersh Ass. Inc.
200 West 57th Street
New York, NY 10019

Riverside Library
Corner 7th & Orange
Riverside, CA 92501

Sawyer Press
P.O.Box 46-653
Los Angeles, CA 90046

Schism
1109 W. Vine
Mt. Vernon, OH 43050

Jack Schnyder
1416 La Brea
Los Angeles, CA 90028

SCN
2700 Bancroft Way
Berkeley, CA 94704

The Seed
245 W. North Ave.
Chicago, IL 60610

Bennett Sims
Grove Press
80 University Place
New York, NY

SIMS
1261 Torrey Pines Rd.
La Jolla, CA 92037

Spokane Natural
P.O.Box 1276
Spokane, WA 99210

Howard Stark
ABC/DUNHILL
449 S. Beverly Drive
Beverly Hills, CA 90212

Win
339 Lafayette St.
New York, NY 10012

S. D. Street Journal
360 Fifth Ave.
San Diego, CA 92101

World Publishing Co.
119 W. 57th Street
New York, NY 10019

Technocracy
13761 Euclid Ave.
Cleveland, OH 44112

Managing Editor
Triton Times, MC250
UCSD
La Jolla, CA 92037

Unicorn Theater
Box 868
La Jolla, CA 92037

Modern Utopian
Starr King Ctr.
2441 Le Conte
Berkeley, CA 94709

Valley Circle Theatre
Mission Valley Center W.
San Diego, CA 92110

View From Here
2809 N. Calvert St.
Baltimore, MD 21208

Vocations for
Social Change
Canyon, CA 94516

Washington Free Press
1522 Connecticut Dr.
Washington, DC 20005

Water Tunnel
Box 136
State College, PA 16801

Willamette Bridge
522 W. Burnside
Portland, OR 97204

52

J

Date prepared

Date received

2/6/70

Received from (name or symbol number)

SD 1155-R INFORMANT

Received by

SA Steven L. Christensen

Method of delivery (check appropriate blocks)

in person by telephone by mail orally recording device written by Informant

If orally furnished and reduced to writing by Agent:

Date

Dictated

2/13/70

to

Date of Report

2/6/70

Date(s) of activity

Transcribed

2/16/70

Authenticated by Informant

2/17/70

2/5/70

Brief description of activity or material

Activities of William Clay

File where original is located if not attached

770-286A

* INDIVIDUALS DESIGNATED BY AN ASTERISK (*) ONLY ATTENDED A MEETING AND DID NOT ACTIVELY PARTICIPATE. VIOLENCE OR REVOLUTIONARY ACTIVITIES WERE NOT DISCUSSED.

100-14293 (Clay)
170-286A - (Clay)
100-12461 (MM)
157-711446

Block Stamp

170-286A-2
SEARCHED _____ INDEXED _____
SERIALIZED 1 FILED _____
JUN - 9 1970
FBI - SAN DIEGO
Christensen

REPORT OF JEROME
February 6, 1970

I talked to BILL CLAY last night. He has been out of touch since last Friday night, and could not be reached by telephone and was never at home when I went by.

Apparently some member of the Minutemen Organization or another right winger is being watched or surveilled and CLAY is quite excited about it. He thinks the FBI is doing the watching and he wants to place a surveillance on the San Diego FBI Office for the purpose of determining the times of arrival and departure of the employees and obtaining the descriptions and license plate number of FBI automobiles. He is going to try to get several people together who will be able to spend time watching the FBI Office.

Jerome

Date prepared

Date received

3/11/70

Received from (name or symbol number)

SD 1155-R INFORMANT

Received by

SA Steven L. Christensen

Method of delivery (check appropriate blocks)

in person by telephone by mail orally recording device written by Informant

If orally furnished and reduced to writing by Agent:

Date

Dictated

3/10/70

to

Transcribed

3/18/70

Authenticated
by Informant

3/20/70

Date of Report

3/11/70

Date(s) of activity

3/10/70

Brief description of activity or material

Names + addresses from MDM phone book
obtained by MM members, 3/10/70, at
MDM office

File where original is located if not attached

170-286A

* INDIVIDUALS DESIGNATED BY AN ASTERISK (*) ONLY ATTENDED A MEETING AND DID NOT ACTIVELY PARTICIPATE
VIOLENCE OR REVOLUTIONARY ACTIVITIES WERE NOT DISCUSSED.

100-14892 (MDM)

Index names underlined

170-286A-3

14-91 (Resistance)

170-286A-3

Block Stamp

SEARCHED	INDEXED
SERIALIZED	FILED
JUN - 8 1970	
FBI - SAN DIEGO	

Ch...

3/20/70

Following names, addresses and other information were obtained from a green canvas covered book with the inscription "Duck Power" and MDM Phone Book:

Prisoner Information Support Service
Mark Twain Column
P.O. Box 387
Boston University Station
Boston, Mass. 02215

The Realist Win Magazine Liberation
Leuiathan

Anarchist Revolutionary Calendar
Solidarity
1703 Vine
Chicago, Ill. 60614

Anti-War Groups

Black Referendum
c/o National Comm. of Black Churchman
110 East 125th St. Rm. 503
New York, N.Y. 10035
Telephone 212-862-9628

People to Call for Demonstrations

Students for a Democratic Society -
Patti -
Byron King 453-5754
Veronique 459-7509

Women for Peace and Freedom
Jane 459-2719

Social Workers -
234-8871

Comm. to Defend Bill of Rights
Rhetta Alexander - 262-

New Adult Community 239-2119
Judy Brown
Mike De Vore
Tom Hyde

Grossmont College
Rich Adelman 283-8358

Jerome

Demonstrations

ACLU -

SDSC - Keith Harrison
Steve Barber 224-7859

San Diego State College

A.S. Pres. RON BREEN 286-6571,72
Stud. Mob. Comm. 286-6577
Experimental Coll. 286-6576
Women's Lib. 286-6575
Stan Pincett 281-9910
Stan Weisman

American Federation of Teachers

Bill Hulsey 420-0843

Peace and Freedom Party

Bert Halsema 422-9092

Welfare Rights Organization

Univ. of Calif. San Diego -

Bill Coates 459-0165, 453-2000 Ext. 1943
J. Stuart Innerst 459-3174
S.D.S.

Law Students

Alex Landon 282-2610
Jack Jacobson 234-2068
David Rico 222-9914
Dan Marlowe "
Bob Cowan "
Leonard Ramey 244-9202

Mothers for Peace

Sylvia Shapiro 583-1626
Dorothy Cleary 454-5637

Women's Internatl League for P. & E.

Florence Stevens 755-4283

GRAPE BOYCOTT

Carlos Le Grette 295-4200

LA RAZA

Salvador Roberto Torres 234-6008
Richard Gonsalves MIC Leave message

Individuals

DEREK CASADY

BOB and PAM MANG,
Telephone 459-7212

ERNIE MASON
Telephone 488-7686

MARSHA and MONTE MAHAN,
Telephone 278-6546

DICK PENCE
Telephone 282-1871

WES PAUL
Telephone 488-1310

NANCY ROTTKE
Telephone 277-1393

PAUL STEIN
Telephone 281-8108
Telephone 295-5632

MARIBETH SPEARMAN
Telephone 281-0323

DON SCHLABACH
Telephone 233-5045

RON SNOWDEN
Telephone 233-7936

RON FRUJILLO
Telephone 233-3218

DON THOMPSON
Telephone 283-1290

Advertising

Stone Front

Dr. GEORGE ABBOTT
Home 488-4421
Office 291-3330

American Serviceman's Union
ANDREW STAPP
156 Fifth Ave. Rm. 538
N.Y., N.Y., 10010
Telephone 212-675-6780

RHETTA ALEXANDER
Telephone 463-4725
Telephone 235-9265

ACLU
PETER CLARK

ARTISTS - helpful
MARIE BRUMUND
1874 Ocean Front
Del Mar, Cal. 92014

BLASE BONPANE
213-661-2751

ROBERT O. BLAND
756 Bluebirth Canyon Dr.
Telephone 494-7609

RON BREEN
Telephone 286-6571, 2

JEFF BENJAMIN
Telephone 453-2000 Ext AS Pres. Office

TED BUMER
Telephone 223-8556
Telephone 223-6313 Home

DEE BAER
Civilian Supporter
Teacher UCSD

BERKELEY BARB
Box 5017
Berkeley, Calif. 94705



STEVE BARBER
SD STATE ACLU
Telephone 224-7859

Los Angeles
Black Panther Party
(Central Communications)
2043 E. Stockwell Ave.
Compton, Cal.
Telephone 635-8991
Telephone 635-2536
TOMMY, STEVE, ROBERT (Community Center)

KEN CLOKE
421 Maine St. #A, Santa Monica
Telephone 396-9801 1711 Pacific Ave., Venice 392-4177

City Transit
Telephone 239-8161
Mr. Garland (P.R.) 239-1251

Comm. of Small Mag. Editors and Publishers
P.O. Box 703
San Francisco, Cal. 94101

Prof. MICHAEL J. CAMELLA (SDSC)

Peter CLARK
lawyer
Telephone 234-8577

BILL COATES
Telephone 459-0165
Telephone 453-2000 Ext 1943

TOM CSEKEY
1136 E. Guerrero St.
San Fran. Cal.
Telephone 415-282-7740

ROGER CROWBRAGER
Defenders Inc.
Telephone 488-3026

Community of Liaison with Families of
Servicemen Detained in North Vietnam
365 West 42nd St.
N.Y. City, N.Y. 10036

Coffee Houses

U.F.O. Coffee House (Ft. Jackson)
1732 Main St.
Columbia, South Carolina 29202
Telephone 803-256-9438

The Oleo Strut (Ft. Hood)
101 Avenue "D"
Killeen, Texas • 76541

The Shelter Half (Ft. Lewis)
5437 S. Tacoma Way
Tacoma, Wash. 98409
Telephone 206-GR-5-9875
Ft. Ord

Construction

Wess Paul (Elec. Engineer)
telephone 488-1310

Bob Eisela (Electrician)
Telephone 283-7779 After 6:00 PM

Crash Pads for G.I.s
Cliff and Sherry Connover
Telephone 295-8979
(Room for people to crash)

Chula Vista Star News
(LOWELL BLANKFORT)
Telephone 427-3000

Concerned Students Union
Riverside City College
3650 Fairfax Avenue
Riverside, Calif.

Churches for activities

Calvary Presbetyrian
Rev. Schwitzgebel

Unitarian

Chollas View Methodist
Ed Hansen 264
47th and Hilltop

YMCA

GEORGE DILLINGER, M.D.
Psychiatrist 459-2693
7255 Girard, La Jolla

DONALD DUNCAN
213-783-7669
15461 Del Gado
Sherman Oaks, California
91403

RON DREY
233-2806
Co. 25

DRAFT RESISTANCE
DEBBIE BURTON 232-3671

BARBARA DANE
43 Strong Rd.
Brooklyn, N.Y. 11231
212-855-5563

KEN DUPRE
American Serviceman's Union
1434 Maaloa St. Room 9
Honolulu, Hawaii 96814

REGINA Comm. of American Deserters
1326 Hamilton St.
Regina, Saskat.
Telephone 527-2787

Defenders

Alex Landon (law student)
telephone 282-2610

Skip Miliron (student at Cal West)
Telephone 469-4920

Dick Pence
3003 46th St.
San Diego, Cal
Telephone 282-1871

LENOARD RAMEY
(Law Student Radical)
Telephone 244-9202

DON SCHLABACH
Telephone 233-5045

STANELY WEISMAN
Telephone 465-5919

DAILY AZTEC *
Telephone 286-5000

JUDY DIGGENARO
Committee Against Fascism
Telephone 488-5403

Entertainment

Soul Music Band
Play at Aloha 11:30 AM
Jesus Carranga Valdez
Calle La B Juarez 1549
Call Telephone 5-75-37
Tijuana, B.C., ask for Louis

STEVE KING (SINGER)
YWCA 233-1333
Lifeline 233-5233
4321 Riolto
Ocean Beach 92110

BARBARA DANE

Band "Of the People" 213-455-2151
CHARLES GALVIN
20800 E. Hillside Dr.
Topanga Canyon, Cal. 90290

KEN BLOOM
Folk singer guitarist
(blues)



QUIN ELLIS
"D" Company
C & E Battalion
MCRD

Education
People to Wirte to for literature

New England Free Press
791 Tremont St.,
Boston, Mass. 02118

Radical Education Project

Young Socialist Alliance - LA

Chicago Area Draft Resistance

Fred 281-8468

Dr. WILLIAM R. FRAZER
UCSD Biology

Fund Raising

Tom Dotty 755-7267
1442 Camino Del Mar
Del Mar, Cal. 92014

SYLVIA SHAPIRO
Telephone 583-1626

PAUL STEIN
Telephone 281-8108
Telephone 295-5632

DON THOMPSON
Telephone 283-4290
4328 $\frac{1}{2}$ 46th Street
San Diego, Cal. 92115

CARL GILMAN
4901 Marborough Drive
San Diego, Calif.
92116
Telephone 283-9431

NANCY GARNER

Telephone 298-6746

G.I. Civil Liberties Def. Comm.

Box 355 Old Chelsea Station

New York, N.Y. 1011

Tel. 212-243-4775

JIM GALLOWAY SMC

Telephone 453-2000 Ext. 1943

G.I. Student Union

Joe Woodard

2214 Grove St.

Berkeley, Cal. 94704

Green Machine

P.O. Box 1356

Vista, Calif. 92083

Telephone 724-1563

MILTON IRA GREEN

23090 Parklawn

Oak Park Michigan 48237

Area Code 313-541-2147

GROCR FAWTC

222-6311 Ex. 1120 768

Good Times (undgrd, newsp.)

DANNY MONDSCHIEN

c/o Brian Kean

1666 Broadway

San Fran. Cal 94109

House of Africa

Telephone 239-5729

RON HARRIS

Telephone 225-6836

MARH HARVEY

ACLU

(Lawyer)

JIM HAWLEY

S.O.S.
843-8209

Hawaii Resistance
1035 University Avenue
Room 203
Honolulu, Hawaii 96814
Phone 955-1026

J. Stuart Innerst
(author and lecturer)
Telephone 459-3174

Independent
(Neil Good or Chet Dunnell)
Telephone 232-3841

JIM JANUARY

4066 234d St.
San Francisco, Calif

ALEX JORDAN

Telephone 437-5917
Room 411
(Tower 781)

KFMB (channel 8) Newsroom
CARL GILMAN
Telephone 232-2114
Telephone 232-2118

KPRI
Telephone 239-1385
Mr. BARNARD - Station Manager

JUDY KATZ 583-4184

JOE KELLY (home) 282-8819)

WALTER H. KOPPELMAN

8565 Dualson Dr.
Telephone 465-5669

HAROLD KEEN

232-2118

KCBQ

Telephone 583-1100

Oscar Anderson
10:00 PM
Telephone 448-4525

JAY KING
Telephone 465-6410

Long Beach Moratorium Comm.
JERRY SEEDBURG
Telephone 434-3744
2818 E. Anahiem
Long Beach 90804

London Ltd.
Telephone 488-8566

Little Mexico
Telephone 582-0139

Prof. Herbert L. Lozerow
School of Law USD
Telephone 291-6480

Long Beach - MDM
JOHN FRANZONE
2605 E. 15th
Long Beach, Cal
Telephone 438-0092

Liberation News Service
160 Clairemont Ave.
New York, N.Y. 10027

Leviathan
2700 Broadway
N.Y., N.Y. 10025

LINK
1029 Vermont Ave. N.W. Room 200
Washington, D.C. 20005

Legal
ACLU

TED BUMMER
223-8556
223-6313 Home

PETE SAVITS
Telephone 488-2828
Telephone 454-5895 Home

JACK JACOBSON
Telephone 234-2068 (Law Student)

DAVID RICO
Telephone 222-9914 (Law Student)

DAN MARLOWE
Telephone 222-9914 (Law Student)

BOB COWAN
Telephone 222-9914 (Law Student)

S.D. STATE ACLU
STEVE BARBER
Telephone 224-7859

G.I. Defense Organization
431 S. Dearborn, Suite 813
Chicago, ILL. 60605
Tel. 312-922-0065

G.I. Civil Liberties Def. Comm.
Box 355 Old Chelsea Station
New York, N.Y. 10011
Phone 212-243-4775

Legal

Peter Clark
Charles Curry
Phone 234-8577

Worker's Defense
112 East 19th St. Rm. 405
New York, N.Y. 1003

JOHN F. MANFREDONIA
G.I.
Telephone 447-4386

MIRAMAR CONTACTS
PRICE 271-3526



MAYNARD'S
Mr. Polous
Telephone 488-9393

DONNA MICKELSON (SDS)
373 Green St.
San Francisco

DUNCAN MC CARTY, M.D.
Telephone 274-1734

Dr. MYNAM MALINOVICH,
Telephone 459-7193

MELVON MURPHY
Telephone 583-4641

Military Counseling
520 E Street Room 512
S.D. 92101 FRANK RAU
Office 234-1305 Home 282-2302

New Mobilization Comm. To End War
1029 Vermont Ave. N.W.
Wash. D.C. 20005

Alphonso Macy
Telephone 298-6618

JIM MAHONAY
Telephone 295-9873

MDM Support Comm. L.A.
SUSIE PACKER
Telephone 472-2755
Telephone 825-1394, 95
396 N. Kenter Ave.
Los Angeles, Cal. 90049

Frank Hagler
Telephone 213-655-4750
Telephone 213-936-7632

The Movement
345 Franklin Street
San Francisco, Cal. 94102

San Francisco Mime Troupe
450 Alabama St.
San Fran 94110
Telephone 415-431-1984

Ministers

ED HANSEN
Chollas View Methodist Church
JIM NESSHIEM

BRUCE NEWBURGER
1726 Lincoln Street
Berkeley (Marxist)

Newsreel - Jonathan Aurthur
1431 W. Washington Blvd.
Venice, California 90291
Office 233-9739
Home 396-1206
PETER 396-1206

NEWSREEL - S.F.
541 Courtland Dr.
San Francisco

DAVID W. NEPTUNE, Quaker
College YMCA and YWCA
Telephone 469-4853

DAVE NORTON
Telephone 459-2763

North Island
Enlisted Men's Club
Telephone 437-7046

In event of a bust

News Media - Helpful
PETER LARNES
Newsweek, Fox Place Suite
1008 San Francisco, Cal 94102

HAROLD KEEN
Telephone 232-2118

Independent
Neil GOOD

Channel 15
PETER KAY 755-2209

KCBQ
Oscar Anderson
Telephone 583-1100

KGB
Ted TAYLOR
Telephone 297-2205

UPI
Telephone 234-7111
A.P.
Telephone 234-7111
Los Angeles Times
Telephone 281-5354
Telephone 296-0776

Chula Vista Star News
Telephone 487-3002
ALICE BLANKFORT
Telephone 427-0760

Dr. PETER O'REILLY
5757 College Ave. (Apt YY)
San Diego, California 92120
Telephone 286-7475

O.B. TRILOGY

(Landlord)
I.J. OLSHER
Telephone 232-0829
953 8th Avenue
Telephone 281-6078
San Diego, Cal. 92101

JERRY POPKIN
c/o Daily Calif.
Berkeley, Cal.

Prof. RICHARD H. POPKIN
Telephone 453-2797

PRINTER

Telephone 213-330-1601
Alfred's Newspaper Printing Co.
14921 Proctor Ave.
City of Industry, Cal. 91744

Photographers that want to help

11th Naval Dist.
(P.A.) Telephone 235-3534

People's Defense Committee
Chris KENYON 483-9917

PATRIOT PARTY
Telephone 415-569-6370
2812 73rd Ave.
Oakland, Cal.

GEORGE ELGIN
Telephone 286-9257

DOUGLAS J. PFEIL
Telephone 748-1165

CAMERA DEFENSE - Busts etc.
City College
Publications Office

JOE CHAPMAN
PETER TUCKER
CHUCK HUNTS

RICHARD JOSEPH ANTHONY PEIJAK
8R1 Bayridge Blvd.
Willowick, Ohio 44094

JOCUM RICHARD ROSE
Public Affairs Office
Com Phib Pac
San Diego, Calif
92155

RUZA
469-4887

Ramparts Magazine
495 Beach St.
San Francisco, Cal.

Jack RIPPER
People's Office
1925 Grove St.
Berkeley, Cal 549-3977

Shore Patrol Headquarters
Telephone 239-5158

Stone Front
(Head)
4820 Voltaire
Ocean Beach, S.D.
Telephone 223-9524

Synthetic Trips
Telephone 282-1445

Peter Savitz
Lawyer
Telephone 488-2828

SYLVIA and ALEX SHAPIRO
6952 Eldridge
Telephone 583-1626

Rev. Richard B. Salwitzzel
Telephone 479-2725

Mrs. Merillee Seade
Telephone 286-3723

MARTY SCHNOEPPER
Co 25
Barracks 239-9760

TOM-SKI
Telephone 271-2597

L. A. Moratorium
Telephone 380-4085
3848 Ingraham
Los Angeles, Cal. 90005

Support O.S.
P.O. Box 3061
Oakland, Cal. 94609
JIM HAWLEY's 843-8209
ANDY EPSTEIN 824-1986

SDS at UCSD
BYRONNE KING 453-5754
BRUCE COSTON 755-3793 or 453-2000 X-2049

SPEAKERS

JOYCE NOWER

Prof. At State
Racism Class Oppression
Black Power, Lit.
Telephone 463-4725

PRESCOTT NICHOLS.

Prof. at State.
Black Lit.
Telephone 291-1158

BOB RUSSELL

Teacher at S.D. High
Black History
Telephone 264-7764

AL CRISTA

Chicano Cultural Revolution
Chicano, Lit. and History
Telephone 281-4838

GUS SEGADE

Chicano History, Mexican History
Telephone 286-3723

CARLOS LE GRETTE

2422 Congress St.
San Diego, Cal.
(Grape Boycott Organizer)
Telephone 262-2950

GRACIA DE PICK

Chicano Lit. (FIERY)

BILL HULSEY (AFT)

Collective Bargaining, revolution
Telephone 420-0843

BERT HALSEMA

P & E Party, old radical
Economy control in U.S., class nature of
society, ecology, imperialism, revolutionary view of
U.S. history

Ecology Action Comm

Young Socialist Alliance

Transportation

JOHN MEISTER

San Diego

Has no phone will call periodically
has 9 people station wagon

DICK LE BRUN

telephone 239-8994

RON TRUJILLO

JANET WOOD

DEREK CASSIDY

MIC

DON EITER

USSF

United States Serviceman's Fund

(See Donald DUNCAN)

Prof HERMIT VAUDERBILT

Telephone 465-3706

Rev. NEIL VOIGHT

Telephone TU4-8508

USSF (U.S. Servicemen's Fund

430 W. 250th

Riverdale, N.Y. 10471

(212-884-3600)

P.O. Box 3061

(415-653-5820)

Oakland, California 94609

USSF

SUE SCHNALL

CORNIA FALES

Greenwich Village Peace Center

135 West Fourth Street

N.Y., N.Y.

Telephone 533-5120

Vietnam G.I.
P.O. Box 9273
Chicago, Ill. 60690

White Whale
Telephone 454-6580

JARY WOODLE
4424-51st
Telephone 287-0269

Dr. STANLEY WEISSMAN
7516 Parkway Dr.
La Mesa 92041
Telephone 465-5919

KINGSLEY WIDMER (AFT)
Telephone 285-5172

Date prepared

Date received

3/20/70

Received from (name or symbol number)

SD 1155-K INFORMANT

Received by

SA Steven L. Christensen

Method of delivery (check appropriate blocks)

in person by telephone by mail orally recording device written by Informant

If orally furnished and reduced to writing by Agent:

Date

Dictated 4/1/70 to _____

Transcribed 4/6/70

Authenticated by Informant 4/9/70

Date of Report

3/20/70

Date(s) of activity

3/10/70

Brief description of activity or material

Names + addresses from MDM phone book obtained by MDM members at MDM office 3/10/70

File where original is located if not attached

170-286A

* INDIVIDUALS DESIGNATED BY AN ASTERISK (*) ONLY ATTENDED A MEETING AND DID NOT ACTIVELY PARTICIPATE. VIOLENCE OR REVOLUTIONARY ACTIVITIES WERE NOT DISCUSSED.

100-14892 (MDM)

170-286A-4

Index names underlined

170-286A-4
Block Stamp

SEARCHED _____ INDEXED _____
SERIALIZED _____ FILED _____
JUN - 8 1970
FBI - SAN DIEGO

3/20/70

The following names, addresses and other information were obtained from a book with the inscription "The Book:"

Phone Numbers

Lawyers:

SAVITZ
PETE (SAIRTZ)
ACLU
Office phone 488-2828
Home phone 454-5895

San Diego County Bail Fund
(Dr. Nower)
ACLU

San Diego Committee for
Defense of Const. Rights

ACLU, S.D. State
KEITH HANISON, Pres. 583-1026
(Might know lawyer)

MARY HARVEY, ACLU 233-0149
(Immed. Leg. Aid for blocking
sidewalk, etc.)

RODGER CROBARGE
State Office, Defenders Inc.
Telephone 724-1563

KEN CLOAKE
(L.A.)

CHARLES K. HOUREY
ACLU
Phone 239-8424

BRAD HETTER
Telephone 291-6970

TED BUMER
Telephone 223-8556 Office
Telephone 223-6313 Home

LON CATZ



Organizations which are friendly

YSA

ALAN STANCLIFF

Telephone 296-4029

SMC

SHERRY SMITH

JESS SMITH

Telephone 583-2762

CMC

BILL COATS

Telephone 453-2000, Ex. 1943

Telephone 459-0165

HENAC, UCLA Suzie Parcker

Telephone 825-1394

Urban Coalition League

BIL SAUNDERS

SDS DON DUNCAN

Telephone 783-7669

V.V.A.W.

Telephone 380-3611 (L.A.)

ACLU (State)

Telephone 298-6547

WALT KENNEDY (RACOP)

KEITH HARRISON, Pres.

Telephone 583-1026

The Conspiracy

Svs. H. ACHWAY

Area 361224

482471471471471436

SDS

W. C. OPLEMAN

48612510510612

612918

Conspiracy Def. Fund

28 E. Jackson

Chicago, Ill.

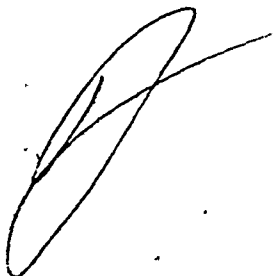

Aztec (State)
Pol. Reporter Jim Evans
Editor
Bob Melton

Open City (Detroit)
4425 2nd Ave.
Detroit, Mich.
JOHN MARTIN, co-ordinator
(what's happening in Detroit; good need for
MDM in that area.)

JUDY D. IGGENARO
48816816510480036
Committee Against Fascism
Will cal Monday
Rich radicals??

West Coast Councelling
234-1305

Friends

Dr. and C. Olleen
(aa/bb) (a2b2)
229254849878916

LODGE and SHERY C. ORNOVER
229254849878916
(aa/bb) (a2b2)

J. LIGHTERBLACK
24714816128164800
(2xx).

MICHAEL D. OWNING
bbgcfhe

BOB S. LUBLE
egiidfi

GARY GAUBLEY
dgaefie

BONNIE ZELL
228264348878616
A2b2

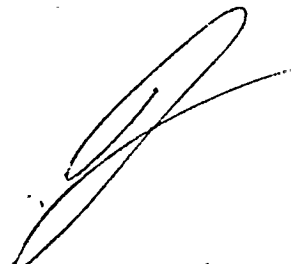

BRAD HOPHTIZER
1232445498Happyrock
Sylmar, Cal.
3661271436510816612
(x xx x) wants to start paper

JON BALKIND
7149186121236 E 4th LA
Wants asst. lit. on nationwife FP's

DONALD D. UNCHAN
71481636714612
61298
12S104861212 Delg.

LEE ON
4851036487142410

MICHAEL D. OWNER
48488161271491824
(Advertising for film)

BOB STUBLE
2481661261251071412
ditto

PAM WILLIAM
248161714120071424

MIKE HEUMANN
24816129182471412

ALAN LANE
4871491836480048

PIGS
Detective Division (nark)
L.B. Watson #940 232-6981 Ex 298
Known to have tried to get undercover agents
Big, black, well dressed dude

Earth Child
542 6th (Near Market)
Apt. 24

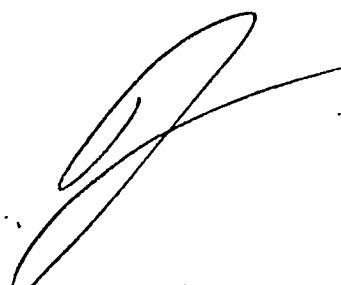

JANE B. ROWN
24714816128164800
Hwy. 36918510 to x

BARB HOWARTH
4871491848714510816

DOUG RECHARD

MIKE H. EUMANN
24816129182471412

Poli. Sci. Class

BRUCE COSTON (SDS)
~~755-3793~~
or 453-2000 x 2049

SUSY WEINSTEIN
Keri Krust
state Coll.
24816363671400918

JOHN HANAKER
24369K2451081600
1245 16th Ave.
MCRD

Violence must result only as a direct result of aggression in order to prevent false images of riotous tendencies.

We are not, and will not be, a leftist "minutemen" organization.

PP 157 C15 #1 1938

Publisicty

Free Presses National
and Good papers and local
HAROLD KEEN
KGB Radio

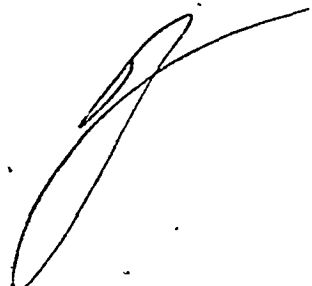

SHERWOOD GORDON
KSDO Radio

UCLA BRIAN "TODD" 825-2020
308 Westwood Pky.
90024 c/o Brian
RICK HEIR letters to Editor

Good Times
2377 Bush St.
S. Fran.

234-7111, ext. 350
Friendly Reporter

People's Bread 145.00 balance
Feb 13 expenses 2.50 gas
1.82 groceries



Date prepared

Date received
3/17, 3/20,
3/23/70

Received from (name or symbol number)
SD 1155 - INFORMANT

Received by
SA Steven L. Christensen

Method of delivery (check appropriate blocks)

in person by telephone by mail orally recording device written by Informant

If orally furnished and reduced to writing by Agent:

Date

Dictated 4/1/70 to _____

Transcribed 4/6/70

Authenticated by Informant 4/9/70

Date of Report

3/17, 3/20 + 3/23/70
Date(s) of activity

3/14-20/70

Brief description of activity or material

Pro-CP material at Scripps Oceanography
Contact with Jerry Tartaglio, Santa Ana
~~Activities Frank Yacopac~~

File where original is located if not attached

170-286A

* INDIVIDUALS DESIGNATED BY AN ASTERISK (*) ONLY ATTENDED A MEETING AND DID NOT ACTIVELY PARTICIPATE. VIOLENCE OR REVOLUTIONARY ACTIVITIES WERE NOT DISCUSSED.

~~100-12451 (MM)~~ 157-1748

170-286A-5

100-~~14661~~ (Jerry Tartaglio)

100-14661 (Frank Yacopac)

~~100-14293 (Cly)~~

157-800 (Herschler)

170-286A-5
Block Stamp

SEARCHED _____	INDEXED _____
SERIALIZED 7	FILED _____
JUN 3 1970	
FBI - SAN DIEGO	

[Handwritten signature]

Date dictated

March 17, 1970

By JEROME

I was at Scripps Institute of Oceanography a couple of days ago on business and toured a considerable part of the facilities. I had occasion to observe a large amount of pro-Communist literature and references on the bulletin boards. In a number of classrooms I observed the slogan "The only true freedom is true Communism, Communism, Communism," written on the blackboards.

March 20, 1970

By JEROME

I am going to be spending Friday evening and all day Saturday at Los Angeles, California. On the way, I intend to stop in Santa Ana and contact JERRY TARTAGLIO and make his acquaintance.

March 23, 1970

By JEROME

I got in touch with JERRY TARTAGLIO last Friday evening at his home at 1721 Gunther, Ste. Ave, tel. 531-610. He appears to have many contacts in both the right and left wing elements in the Orange County and Los Angeles, California, area. In particular, he has a contact with a young Jewish fellow who belongs to the SDS somewhere in the Los Angeles area. This person, whose name I did not learn, sells weapons and explosives to anyone who has the money to pay for them. I was told he has hand grenades for sale at about \$5.00 apiece, which is half what they are selling for in San Diego. In large quantities of 100 or more he will reduce the price to \$2.50 to \$3.00. I learned that FRANK YACOPL was at the San Diego County Recorder's Office today and determined that DALL HERSCHLER owns the building where he published the San Diego Free Door. However, HERSCHLER's place of residence for tax purposes was shown as 7053 University, La Mesa, California.

Jerome

Date prepared

Date received

Received from (name or symbol number)

Received by

3/25, 3/26/70

SD 1158-R

INFORMANT

SA Steven L. Christensen

Method of delivery (check appropriate blocks)

in person by telephone by mail orally recording device written by Informant

If orally furnished and reduced to writing by Agent:

Date of Report

Dictated 4/1/70 to _____

3/25 + 3/26/70

Transcribed 4/6/70

Date(s) of activity

Authenticated by Informant 4/9/70

3/24 - 25/70

Brief description of activity or material

Info re Bill Clay + Frank Yacopac
Ted Wolfe.

File where original is located if not attached

170 - 286 A

* INDIVIDUALS DESIGNATED BY AN ASTERISK (*) ONLY ATTENDED A MEETING AND DID NOT ACTIVELY PARTICIPATE. VIOLENCE OR REVOLUTIONARY ACTIVITIES WERE NOT DISCUSSED.

100 - 14293 (Clay)

170 - 286A - 6

100 - (Henry Tartaglio) (open book)

100 - 14661 (Yacopac)

100 - (Ted Wolfe) (open book)

170 - 286A - 6
Block Stamp

SEARCHED INDEXED
SERIALIZED FILED
JUN - 8 1970
FBI - SAN DIEGO
Christensen

March 25, 1970

By JEROME

I was talking with BILL CLAY last night and he is highly interested in JERRY TARTAGLIO and believes he would be an excellent contact. CLAY intends to be in Los Angeles, California, over Easter weekend; Friday, Saturday, Sunday and Monday and he wants me to arrange a meeting with TARTAGLIO at the west end of the bridge over Interstate 5 at Knott's Berry Farm at 9:00 a.m., Saturday morning, March 28, 1970.

March 26, 1970

By JEROME

I have learned that FRANK YACCO was at TED WOLFE's gun shop (Lyle Lanning's Hanging Tree Swap Shop) yesterday and WOLFE showed him a new M-14 rifle which he would sell for \$125. WOLFE does not have the rifle at his store but drove away in his camper pickup truck and obtained the rifle and returned after a short time. He then showed the rifle to YACCO in the back of the camper after which he apparently returned it to the place where he had obtained it.

Jerome

SEARCHED _____
SERIALIZED _____
INDEXED _____
FILED _____
MAR 27 1970
FBI - LOS ANGELES

Date prepared

Date received
3/31/70

Received from (name or symbol number)
[SD 1155-A] INFORMANT

Received by
SA Steven L. Christensen

Method of delivery (check appropriate blocks)
 in person by telephone by mail orally recording device written by Informant

If orally furnished and reduced to writing by Agent:
Date
Dictated 4/1/70 to _____
Transcribed 4/6/70
Authenticated by Informant 4/9/70

Date of Report
3/31/70

Date(s) of activity
3/10/70

Brief description of activity or material
Names & addresses from MDM phone
Book obtained by MDM members at
MDM office 3/10/70

File where original is located if not attached
170-286A

* INDIVIDUALS DESIGNATED BY AN ASTERISK (*) ONLY ATTENDED A MEETING AND DID NOT ACTIVELY PARTICIPATE. VIOLENCE OR REVOLUTIONARY ACTIVITIES WERE NOT DISCUSSED.

100-14892 (MDM)
170-286A-1

Index names underlined

Block Stamp

170-286A-1
SEARCHED _____ INDEXED _____
SERIALIZED 1 FILED _____
JUN - 3 1970
FBI - SAN DIEGO
Christensen

3/31/70

The following names, addresses, and other information were obtained from a small white book bearing the inscription Phone Book of Civilian Helpers with MDM:

ACLU
Perry Langford
telephone 223-3863
Telephone 233-5409

RHETTA ALEXANDER
(Women's Lib)
telephone 262-8422

RICH ADELMAN
Prof. at Grossmont College
Telephone 283-8358

JANE ELLIOTT
755 Loma Valley
San Diego, Cal. 92106
Telephone 223-9898

JACK BREMNER
(minis.)
Christ the King Church (Catholic)
32nd and Imperial
Telephone 233-0700

MARIE BRUMUND
Artist (wants to help)
1847 Oceanfront
Del Mar, Cal. 92014
Telephone 755-7262

NICK and WANN BOYLAN
3833 Costa Bella
Lemon Grove, Cal. 92045
Telephone 469-4920

JANET BROWN
Telephone 278-1840
Wants to Help

PETER BARNES
News Media
Newsweek, Fox Plaza Suite 1008
San Francisco, Cal. 94102

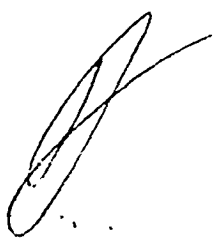

RON BREEN

AS Pres. San Diego State
Telephone 286-6571

DOZEN'S HOUSE

MIKE DEVORE

(Electricity)
Telephone 235-9265

BONNIE DONOVAN

609 Fern Glenn
La Jolla, Cal. 92037

DONALD DUNCAN

15461 Delgado Dr.
Sherman Oaks, Cal. 91403
Telephone 783-7669

TOM DOTY

1442 Camino Del Mar
Del Mar, Cal. 92014
Draft Counseling
UGSD stu. Fund raising
Telephone 1-755-7267

BILL COATS

Chaplain UCSD
CMC
Telephone 459-0165
Telephone 453-2000
Ext. 1943

DOROTHY CLEARY

Helpful lady
Telephone 454-5637

DEREK CASADY

Will Help
Telephone 488-9712

MARY LYNN CLEMENT

8180 Vincetta Dr.
La Mesa, 92041
Women's Lib.
Telephone 463-6968

Citizen's United For Racial Equality

Mrs. Margolis
Telephone 279-8809

CRISIS CENTER
FREE CLINIC MWF = 6 - 10
Telephone 239-0325

ANGELA DAVIS
213-737-6932

DEFENDERS INC.

DREY, RON.
c/o Evan Evans 2915 Rutland
Des Moines, Iowa 50311

GEORGE ELGIN
(Photographer)
Telephone 286-9257

DON EITER
Trans. Typewriter
Telephone 233-9453

JARRY FARBER
Non-Violent Action
Author of "Student as Nigger"
Telephone 465-1178

HARVEY FURGATCH

JACKY FRIEDLAND
Days Free
Wants to help
Telephone 283-9100

SYDNEY GLASS

FRANK HAGLER
MDM Support Comm
650 South Detroit Apt. 207
Los Angeles
Telephone 213-655-4750
Telephone 936-7632

ED HANSEN (Minister)
Chollas View Methodist Church



BILL HULSEY
835 Halecrest, Chula Vista
AFT, radical, P&E Party

BERT HALSEMA
P.O. Box 104, Nesten, Cal.
Radical, D & F Party
Telephone 422-9092

TOM HYDE
New Adolf Comm, radical

JIM HAWLEY
P.O. Box 3061, Oakland, Cal.
Support our Soldiers in S.F.
Telephone 415-843-8209

J. STUART INNERST
(Quaker)
5840 Camino De La Costa
La Jolla, Cal. 92037
Telephone 459-3174

HEENAC
Telephone 213-825-1394,95

RON KEY
(Construc.)
Telephone 488-6179

STEVE KING
(Entertainment)
(Singer)
YWCA
Lifeline
4321 Riolto
Ocean Beach, 92110
Telephone 233-1333
Telephone 233-5233

CHRIS KENYON
Telephone 488-9917

JAY KING
Telephone 465-6410



ALEX ALNDON

(Law Student)

Defenders

Telephone 282-2610

PHYLLIS LA GRANGE

DICK LE BRUN

(Trans.)

(Will help take G.I.s to functions and take them out when pig gets heavy)

Telephone 239-8994

DONNA MICKELSON

373 Green St.

San Francisco, Cal.

Telephone 415-434-1619

GEORGE MERCER

La Jolla, Cal.

DAWN MC CURIO

6342 Imperial Ave. S.D. 92115

Telephone 264-5835

PAM MANG

Fund Raising

Telephone 459-7212

EARNEST MASON

(Fund Raising Possibility?)

Telephone 488-7686

SKIP MILLIRON

(Student at Cal West.)

Defender

Telephone 469-4920

JACK RIPPER

People's Office 1925 Grove St.

Berkeley, Cal.

MONTE MAHAN

3435 Dorchester Dr.

SD

Friends

Telephone 278-6546

MICHA MAGUIRE
10712 Wilshire Blvd.
Los Angeles, Cal
Messages 473-0059
Prisoners Hght.
Telephone 213-474-4300

JIM NESSHIEM.
Lutheran Campus Center
5863 Hardy Dr 92115
Telephone 583-3972
Telephone 286-1945

New Adult Comm.
Exposure Education
1924 Island Ave S.D. 92102
Telephone 238-2119

Prescott Nichols
1787 Neale St., San Diego
Rad. Prof. at State (Black Literature)
Telephone 291-1158

LEON NOWER
Prof. at State - Radical
Telephone 463-4725

WALT PARKMAN
Telephone 448-5093

DICK PENCE
Defender
3003 46th Street
San Diego, Cal.
Telephone 282-1871

STAN PINCETL
Prof.
Telephone 281-9910

WES PAUL
Elec Engineer
Telephone 488-1310

DOUGLAS J. PFEIL
Photographer
Telephone 748-1165

SUSIE PACKER
396 N. Kenter Ave.
LA., Cal. 90049
Telephone 478-8929
Telephone 472-2755
Telephone 825-1394
Telephone 825-1395

GRACIA DE PICK
Articulate on Chicano Lit.

PATTI PARMELEE
Massachusetts
Telephone 213-938-9347

JERRY PETERSON
280 K St.
Chula Vista, Cal.
Telephone 427-7248

JOAN ROTTER
1151 14th St.
Imperial Beach 92032
Telephone 424-7470

NANCY ROTTKE
6750 Beadnell Way Apt. 49
San Diego 92117
Telephone 277-1393

LEONARD RAMEY
Law Student Radical
Defender
Telephone 244-9202

ROGER RUFFIN
Judge - get O.R.s from
telephone 459-6374



SYLVIA SHAPIRO
Fund-raising
Telephone 583-1626

PAUL STEIN
Fund-raising
Telephone 281-8108
Telephone 295-5632

MARIBETH SPEARMAN
4273 Highland Ave.
Apt #2
San Diego, Cal. 92115
Telephone 281-0323

FLORENCE STEVENS
Women's International League for P & E
Telephone 755-4283

DON SCHLABACH
Defender
Telephone 233-5045

ALAN STANCLIFF
YSA
Telephone 296-4029

Support Our Soldiers
373 Green St.
San Francisco, Cal.,

RON SNOWDEN
(plumber)
Telephone 233-7936

Students for a Democratic Society
1608 W. Madison
Chicago, Ill 60612

RON TRUJILLO
2674 Island Ave.
San Diego, Cal. 92102
Telephone 233-3218

LINDA TYLER
6288 Stanley Ave.
San Diego, Cal. 92115
Telephone 286-9651

DON THOMPSON

(Fund raising)
4328½ 46th Street
San Diego, Cal. 92115
Telephone 283-4290

JOHN WELDON

Telephone 488-9468

WESLEY Foundation
5225 Campinile, S.D.
Radical Center at State
Telephone 582-0772

STANLEY WEISMAN

Prof Defense
Telephone 465-5919

GLEN WORSTELL

12340 Oak Knoll Rd.
Poway, Cal 92064
Stud. at State
Telephone 748-2714

NANCY and PETER WEILER

1431 Inspiration Dr.
La Jolla, 92037
Telephone 459-7632

JIM WALDECK (typewriter) (Learner by GRANT).

Telephone 286-3836

RON WARREN

JUDI SHAYNE

Liberation Union MDM Support

Place to crash in L.A.

13107 Margate

Van Nuys, Cal. 91401

Telephone 783-3861

MILT ZAZLOW

3824 Evans St., Los Angeles 90027

C.P. In Los Angeles

Telephone 213-662-7269

High School Students

JOAN ROTTER
1151 14th Street,
Imperial Beach, 92032
Telephone 424-7470

REBECCA BURNETT
3232 Elliott
San Diego, 92106
Telephone 222-3330

NANCY ROTTKE
6750 Beadnell Way Apt. 49
San Diego, Cal. 92117

IRV ALPERT
Telephone 287-0264

WALT PARKMAN
11675 Oak Creek Dr.
Lakeside, California 92040
Telephone 448-5093

LISA KATZ
5640 Dorothy Way
San Diego, Cal. 92115
Telephone 583-4184

JIM GRIPP
4441 Carmén Dr.
La Mesa, Cal. 92041
Telephone 442-3532

Date prepared

Date received 2/5/70 Received from (name or symbol number) [SD 1155-S] INFORMANT Received by SA Steven L. Christensen

Method of delivery (check appropriate blocks)
 in person by telephone by mail orally recording device written by Informant

If orally furnished and reduced to writing by Agent:
Date Dictated 2/13/70 to _____
Transcribed 2/16/70
Authenticated by Informant 2/17/70

Date of Report 2/5/70

Date(s) of activity 2/5/70

Brief description of activity or material
Activities of Frank Yacopac, Paul Ruplinger & Peter Ruplinger

File where original is located if not attached
170-286A
~~134-717A~~

* INDIVIDUALS DESIGNATED BY AN ASTERISK (*) ONLY ATTENDED A MEETING AND DID NOT ACTIVELY PARTICIPATE. VIOLENCE OR REVOLUTIONARY ACTIVITIES WERE NOT DISCUSSED.

- 100-14661 (Yacopac)
- 770-286A-S
- 100-14301 (Ruplinger)
- 100-14356 (Peter Ruplinger)
- 100-14911 (Peoples Commune)

170-286A-8
(Block Stamp)

SEARCHED <u>for</u>	INDEXED <u>---</u>
SERIALIZED <u>1</u>	FILED <u>---</u>
JUN - 3 1970	
FBI - SAN DIEGO	

[Signature]

REPORT OF JEROME
February 5, 1970

I learned today that FRANK YAKOPEC found a dead skunk on the road yesterday which he picked up, placed in a cardboard box, which he then wrapped in a plastic bag, and born paper on the outside. He mailed this package from the Del Mar Post Office yesterday addressed to JAN DIEPERSLOOT at the Peoples Commune.

He was told that the Minutemen are going to try to begin printing a news leaflet that publicizes names and activities of interest among the left wingers.

I talked to PAUL RUPLINGER this morning who said he would like to get some kind of harassment going again against Professor MARCUSE at UCSD. RUPLINGER also said that his son PETER RUPLINGER has a close personal friend who he knows has been informing on both left and right wingers for the FBI, for about a year. RUPLINGER said he intends to make this person's name known to a number of people so as to destroy his activities as an informant.

Jerome

Date prepared

Date received

3/6/70

Received from (name or symbol number)

SD 1155 - (R)

Received by

SA Steven L. Christensen

Method of delivery (check appropriate blocks)

in person by telephone by mail orally recording device written by Informant

If orally furnished and reduced to writing by Agent:

Date

Dictated _____ to _____

Transcribed _____

Authenticated by Informant _____

Date of Report

3/6/70

Date(s) of activity

3/5/70

Brief description of activity or material

~~CMC planning meeting~~
3/5/70

File where original is located if not attached

170-286A

* INDIVIDUALS DESIGNATED BY AN ASTERISK (*) ONLY ATTENDED A MEETING AND DID NOT ACTIVELY PARTICIPATE. VIOLENCE OR REVOLUTIONARY ACTIVITIES WERE NOT DISCUSSED.

100-14922 (CMC)

170-286A-9

Index: Freitjof Thygeson
100-15063

100-14862 (Coats)

100-14495 (Stancliff)

100-13697 (Shapiro)

100-14527 (Seuter)

100-14075 (Bergman)

100-14376 (St. Journal)

100-14892 (MDM)

100-13378 (William Milson)

Block Stamp

170-286A-9

SEARCHED	INDEXED
SERIALIZED	
JUN 5 1970	

Christensen

MARCH 6, 1970

BY JEROME

I attended the CMC planning meeting in Balboa Park last night. I got there at about 7:10 but the meeting did not get going til 7:35. There were approximately 50 to 60 people present. The meeting was chaired by the Reverend BILL COATS. I saw FREITJOF THYGESON there, however, he left early, in disgust.

I also recognized ALAN STANCLIFF, SYLVIA SHAPIRO and BERNIE SENTER in the crowd. Also present was a young white individual in his early 20s with long dark brown hair. He was wearing a fatigue jacket with red stars on the collar. I heard him refer to as "LLOYD" (Lowell Bergman) and he said he was a representative of the San Diego Street Journal.

Two other persons who spoke at the meeting claimed to be representatives of MDM. One was a clean cut white male with a military look, medium build, about 5'9" tall. He has light colored hair and wearing a Mao-tse-tung style quilted cap. The other was also about 5'9" tall, medium build, long blond hair who wore gold rimmed glasses; a red jacket and camouflage pants.

It was decided there would be city wide peace activity during the week of April 13 to 18, 1970. However, there was a lot of arguments and backbiting as to whether the actual peace march should take place on April 15 or April 18, 1970. It was agreed the march should probably start at noon and that it would be a flop if less than 8,000 people showed up.

The MDM representative with the Mao-tse-tung cap was screaming that people from the military and people with jobs could not come of the rally was held on the 15th, a Wednesday, and finally the MDM and Street Journal people walked out of the meeting. After they left, there was some discussion about a possible compromise where the rally would be held on Wednesday evening and servicemen would be bussed to it.

Before they left, the people from the Street Journal announced that they had moved into new offices but were evicted the same day after the police department talked to their new landlord. They said that they had an offset place which they would use to make posters for the April demonstration.

Jerome

(Lowell Bergman)

"LLOYD" from the Street Journal predicted there would be a breakup in San Diego in the near future due to police department harassment.

During the meeting, it was announced that there would be efforts made to organize a city wide student strike at high schools on April 15, 1970.

It was also announced that MDM would have a mock trial of the military on April 1, 1970, which will be composed of active duty GIs and with MARK LANE as prosecutor.

It was eventually decided that the April demonstration would again consist of a march from downtown San Diego to a rally in Balboa Park.

People were asked to volunteer to work on the various planning committee.

One interesting thing that occurred was a speech by a man from the audience who claimed that the November 15, 1969, demonstration in San Diego was nothing more than a disorganized mob. He said the planning for the peace demonstration was all wrong and that the demonstration should be held on a weekend so workers could join in. He said the people at the meeting should do as had been done where, he said, groups of 30,000 to 40,000 workers had been organized to march down the streets chanting.

This individual seemed to be well known, was a white male, about 60 years old, gray hair, 5'7", and stocky built. He had a flat, round face and spoke with a heavy European accent.

There were no colored people at the meeting.

Jerome

Date prepared

Date received

3/11/70

Received from (name or symbol number)

SD 1155 - [initials]

Received by

SA Steven L. Christensen

Method of delivery (check appropriate blocks)

in person

by telephone

by mail

orally

recording device

written by Informant

If orally furnished and reduced to writing by Agent:
Date

Dictated _____ to _____

Transcribed _____

Authenticated by Informant _____

Date of Report

3/9 + 3/11/70

Date(s) of activity

3/9 + 10/70

Brief description of activity or material

Info re Frank Yacopiec,
MDM & SMC

File where original is located if not attached

170-286A

* INDIVIDUALS DESIGNATED BY AN ASTERISK (*) ONLY ATTENDED A MEETING AND DID NOT ACTIVELY PARTICIPATE. VIOLENCE OR REVOLUTIONARY ACTIVITIES WERE NOT DISCUSSED.

~~100-157-1521 (Frank Yacopiec)~~
~~170-286A-10~~
100-14892 (MDM)
100-13847 (SMC)

Block Stamp

170-286A-10.

SEARCHED <input checked="" type="checkbox"/>	INDEXED <input checked="" type="checkbox"/>
SERIALIZED <input checked="" type="checkbox"/>	FILED <input checked="" type="checkbox"/>
JUN 5 1970	

[Signature]

MARCH 9, 1970

BY JEROME

I have learned that FRANK YACOPEC is getting back together with his family and is planning to move into a rental house on Graves Street in El Cajon. He is supposed to be getting a full time employment and may settle down a little bit.

MARCH 11, 1970

BY JEROME

I stopped by the MDM Office at 429 J Street last night at about 6:45 PM. The place was in mass confusion as there was a camera and some CBS TV Channel 2 people. I learned that they were filming coverage of MDM for a nation wide broadcast to be aired on CBS in the near future.

I also learned that SMC may be planning some kind of anti-draft activity for the middle of this month.

Jerome

Date prepared

Date received
3/12; 3/16;
3/18/70

Received from (name or symbol number)
INFORMANT
SD 1155-R

Received by
SA Steven L. Christensen

Method of delivery (check appropriate blocks)

in person by telephone by mail orally recording device written by Informant

If orally furnished and reduced to writing by Agent:
Date

Date of Report

Dictated _____ to _____

3/12; 3/16; 3/18/70
Date(s) of activity

Transcribed _____

Authenticated by Informant _____

3/12 - 17/70

Brief description of activity or material

Demonstration of SDSC
3/12/70

File where original is located if not attached

170-286A

* INDIVIDUALS DESIGNATED BY AN ASTERISK (*) ONLY ATTENDED A MEETING AND DID NOT ACTIVELY PARTICIPATE. VIOLENCE OR REVOLUTIONARY ACTIVITIES WERE NOT DISCUSSED.

100-14998	(Demo. SDSC, 3/12/70)	Index:
170-286A-11		Steve Nystrom
100 -	(Karl Keller) ^{open} ₁₀₀₋₁₅₀₆₃	Freitjof Thygeson
157-890	(Rhett Alexander)	Bernard Streif
157-891	(Ron Green)	
100-14527	(Bernie Jantzer)	
100-14495	(Alan Standliff)	
157-699	(Sukumo)	

Block Stamp

170-286A-11

SEARCHED	INDEXED
SERIALIZED	FILED
JUN 5 1970	

Christensen [initials]

3/12/70
JEROME

A demonstration began today at San Diego State College and students from the school took over part of the administration building and at one time there were close to 700 students there with more expected to arrive after 4:00 p.m., when classes were out. It has the earmarks of lasting for a long time.

The demonstration was touched off at about noon by a speech given by KARL KELLER at a rally on the library loan. The students are protesting administrative action taken by the school against four professors there.

Food including apples, oranges, carrots, punch and loaves of bread is being passed around in the building and is apparently being prepared at the Wesleyan Foundation Building. Signs have been put up in the building indicating that the restrooms have been "liberated" and are now co-educational. Some marijuana was seen being passed out free. About 100 students have elected to stay over night and are going home in shifts to obtain sleeping bags and other items.

The demonstration appeared to be well planned and some organizers, including RHETTA ALEXANDER for one, were seen communicating with walkie-talkies. Other persons observed taking part in the demonstration were RON BREEN, STEVE NYSTROM, BERNIE SENTER, ALAN STANCLIFF, SUKUMO and FRIETJOF THYGESON.

3/16/70
JEROME

I stopped by State College about 11:00 p.m. last night. There were about 75 students in the halls of the administration building who were painting 30' long banners and placing them on the walls of the administration building. They were also printing leaflets announcing a rally at noon today on campus. LEON NOWER was observed there holding hands with a young girl. BERNARD STREIFF, the french student who claims to have participated in the french student revolt, was also there.

Jerome

3/18/70
JEROME

It has been learned the demonstration at State College has been terminated after students and administration officials reached a compromise on a future course of action to be taken regarding hiring and firing of faculty members.

Jerome

Date prepared

Date received

Received from (name or symbol number)

Received by

4/15/70

SD 1158 - R

INFORMANT

SA Steven L. Christensen

Method of delivery (check appropriate blocks)

in person by telephone by mail orally recording device written by Informant

If orally furnished and reduced to writing by Agent:

Date

Date of Report

Dictated _____ to _____

4/15/70

Transcribed _____

Date(s) of activity

Authenticated by Informant _____

4/14/70

Brief description of activity or material

Info re Jerry Lee Busch

File where original is located if not attached

170-286A

* INDIVIDUALS DESIGNATED BY AN ASTERISK (*) ONLY ATTENDED A MEETING AND DID NOT ACTIVELY PARTICIPATE. VIOLENCE OR REVOLUTIONARY ACTIVITIES WERE NOT DISCUSSED.

100- (Jerry Lee Busch) ¹⁵⁷⁻⁶⁶⁸ ¹⁰⁰⁻¹¹⁴⁷⁹ ^{index} Morris Komins
170-286A - 12
100-14293 (Clay)
100-14015 (Haughton)
~~100-12451~~ (MMA)
157-1798

170-286A-12

SEARCHED INDEXED
SERIALIZED JUN 5 1970

Christensen

APRIL 15, 1970

BY JEROME

I met an interesting individual at BILL CLAY's house last night. He is called "The Judge" and his first name is JERRY. He is about 5'10", to 5'11" tall, 230 pounds, has heavy built, ruddy complexion and is 35-45 years old. He has black hair which is receding, a pug nose, round face and heavy jowels. He carries a brown and .32 automatic pistol and is apparently an excellent shot.

He said he spent 8 years in military intelligence following which he worked for the CIA and then for the FBI at San Diego as an informant. He claimed he was a paid assassin for the CIA. He seemed to be highly intelligent and I was told he was good at make-up and voice imitations. He said he had worked at Hollywood as a bit player.

He claimed that when he worked for the FBI at San Diego, he was assigned to watch TROY HOUGHTON and that he quit at about the time of the Watts riot in Los Angeles. He said he was never a close acquaintance of HOUGHTON but he had followed HOUGHTON a lot and came to the personal conclusion HOUGHTON was a Communist. He seems almost to have convicted CLAY of this also.

As CLAY stated, he had verified that HOUGHTON had been meeting some known members of the Communist Party. BUSH and CLAY were thinking DE PUGH may have become aware of this and had HOUGHTON eliminated. If this is so, CLAY said he was thinking about contacting DE PUGH and humbly apologize for ~~not~~ trying to break away from the national MM organization.

"The Judge" is supposed to be from Virginia, although he has no accent, and apparently hates colored people. He speaks fluent German and Spanish.

CLAY stated he believes one of the leading Leftists in the area is MORRIS KOMINSKY who lives at 400 East Franklin Street, Elsinore, California. He has written a book which is being advertised in papers like the Free Door and the Street Journal. KOMINSKY allegedly moved in high circles in the Federal and local Governments at one time and has supposedly been visited on numerous occasions, high placed Government people, including Congressmen, Senators, and Presidents such as TRUMAN, EISENHOWER, and KENNEDY.

CLAY said he wants some local Right Wing people to visit KOMINSKY and somehow get his signature.

Jerome

Date prepared

Date received: 5/11/70
Received from (name or symbol number): SD 1155-R **INFORMANT**
Received by: SA Steven L. Christensen

Method of delivery (check appropriate blocks)
 in person by telephone by mail orally recording device written by Informant

If orally furnished and reduced to writing by Agent:
Date _____
Dictated _____ to _____
Transcribed _____
Authenticated by Informant _____

Date of Report
5/11/70

Date(s) of activity
5/11/70

Brief description of activity or material
Info re Morris Kominisky

File where original is located if not attached
170-286A

* INDIVIDUALS DESIGNATED BY AN ASTERISK (*) ONLY ATTENDED A MEETING AND DID NOT ACTIVELY PARTICIPATE. VIOLENCE OR REVOLUTIONARY ACTIVITIES WERE NOT DISCUSSED.

100-14376 (St. Journal) Index: Morris
170-286A-13 100-11429 Kominisky
100-1494 (People's Commune)
100-1 (Jerry Busch)

Block Stamp

170-286A-13
SEARCHED INDEXED
SERIALIZED
JUN 9 1970
Christensen

MAY 1, 1970

BY JEROME

Today, I went with "The Judge" to see MORRIS KOMINSKY. KOMINSKY is an order man, 60-70 years of age, about 5'9" tall, curly black hair which has a lot of gray in it, blue eyes. He weights 160-170 pounds, has poor posture, as he slouches and has a pot belly. From his statements, I gathered that he is very much in favor of what the San Diego Street Journal is doing. He said he gave all his records to the Street Journal and claimed that it took 5 Street Journal staff members 8 hours to copy his notes of the San Diego area alone. He claimed he had much more information on Right Wing activities in America and claimed he has spent five years researching information for his new book which will be called "Count Down, USA." He said the first volume of this book which will be an expose on fascism in the United States, will be 800 pages long and the second volume will be 1300 pages long. He seemed to be pleased to talk about his work and as we reported ourselves to be fans of the Street Journal, opposed to fascism, he talked quite freely.

He told us of contacts he has in the San Diego Police Department, of the San Diego District Attorney's Office, and also claimed to have a source of information in the San Diego FBI Office.

KOMINSKY said he formerly had high placed friends in Government and claimed he had been visited at his home in Elsinore by Presidents of the United States such as TRUMAN, EISENHOWER, and KENNEDY.

Jerome

Date prepared

Date received

5/11/70

Received from (name or symbol number)

SD 1155-R

INFORMANT

Received by

SA Steven L. Christensen

Method of delivery (check appropriate blocks)

in person

by telephone

by mail

orally

recording device

written by Informant

If orally furnished and reduced to writing by Agent:

Date

Dictated _____ to _____

Transcribed _____

Authenticated by Informant _____

Date of Report

5/3/70

Date(s) of activity

5/3/70

Brief description of activity or material

Activities of Bill Clay *
Benny Godfrey

File where original is located if not attached

170-286A

* INDIVIDUALS DESIGNATED BY AN ASTERISK (*) ONLY ATTENDED A MEETING AND DID NOT ACTIVELY PARTICIPATE. VIOLENCE OR REVOLUTIONARY ACTIVITIES WERE NOT DISCUSSED.

160-14293 (Clay)
170-286A-14
100-14819 (Godfrey)

Block Stamp

170-286A-14

SEARCHED INDEXED
SERIALIZED JUN 9 1970

Christensen

MAY 3, -1970

BY JEROME

Tonight, I learned that ^{BILL CLAY}~~FRANK JACOBS~~
and BARREY GODFREY were on the UCSD campus and
put up some phoney leaflets about Demonstrator's,
Incorporated (a copy of which is attached), and
some red dye was supposedly dumped on the fountain
on Revelle College.

Jerome

Date prepared

Received from (name or symbol number)

Received by

11/70

SD 1155-A

INFORMANT

SA Steven L. Christensen

Method of delivery (check appropriate blocks)

- in person
- by telephone
- by mail
- orally
- recording device
- written by Informant

If orally furnished and reduced to writing by Agent: -
Date

Date of Report

5/7/70

Dictated _____ to _____

Date(s) of activity

5/6/70

Transcribed _____

Authenticated by Informant _____

Brief description of activity or material

File where original is located if not attached

170-286A

Rally at UCSD attended by MM members

* INDIVIDUALS DESIGNATED BY AN ASTERISK (*) ONLY ATTENDED A MEETING AND DID NOT ACTIVELY PARTICIPATE. VIOLENCE OR REVOLUTIONARY ACTIVITIES WERE NOT DISCUSSED.

- 100-14293 (Clay)
- ~~170-286A-15~~
- 100-14819 (Godfrey)
- 100-157-1520 (Frank Yacopiec)
- 100-14061 (PTF Party)
- 100-157-787 (Warren Nielsen)

Index: Bonnie Norman and all names on attached petition to 100-14061

Block Stamp

170-286A-15

SEARCHED <input checked="" type="checkbox"/>	INDEXED <input checked="" type="checkbox"/>
SERIALIZED <input checked="" type="checkbox"/>	<input checked="" type="checkbox"/>
JUN 9 1970	
Christensen	

MAY 7, 1970

BY JEROME

I have learned, that BILL CLAY, BARRY GODFREY, FRANK YAKOPEC, and BONNIE NORMAN went to a rally in UCSD last night. Some Peace and Freedom Party petitions were being circulated, (attached). I learned there was an individual there, who is an Assistant District Attorney named WALLACE or WOLCOTT who was legal adviser to those present.

WARREN NEILSEN was in attendance. They had bonfire going and were smoking pot and were passing the wine and beer around. There were approximately 500-600 people present at the start, and only about 100 left at midnight, all of whom were very drunk.

Jerome

Date prepared

Date received

Received from (name or symbol number)

Received by

5/11/70

SD 1125- *[initials]*

SA Steven L. Christensen

Method of delivery (check appropriate blocks)

in person by telephone by mail orally recording device written by Informant

If orally furnished and reduced to writing by Agent:

Date of Report

Date

5/8/70

Dictated _____ to _____

Date(s) of activity

Transcribed _____

5/8/70

Authenticated by Informant _____

Brief description of activity or material

File where original is located if not attached

Info re Demonstrations,
May, 1970

170-286A

* INDIVIDUALS DESIGNATED BY AN ASTERISK (*) ONLY ATTENDED A MEETING AND DID NOT ACTIVELY PARTICIPATE. VIOLENCE OR REVOLUTIONARY ACTIVITIES WERE NOT DISCUSSED.

100-15071 - (Demonstrations (leaflets to this file on May, 1970)
170-286A-16

- 100-13847 (SMC)
- 100-14922 (CMC)
- 100-14862 (Coats)
- 100-14995 (Stancliff)
- 100-14733 (Galley)
- 100-14660 (Tanberg)
- 100-14293 (Clay)
- ~~100~~-157-1820 (Frank Yacopac)
- 100-14911 (People's Commune)

~~Index:~~ Freitjof Thyg
100-15063-

Block Stamp

170-286A-16

SEARCHED <i>[initials]</i>	INDEXED <i>[initials]</i>
SERIALIZED <i>[initials]</i>	<i>[initials]</i>
JUN 9 1970	

[Signature]

ON MAY 8, 1970,

BY JEROME

Today, I went to a meeting at the Greek Bowl at State College to find out about the march route for the anti-war demonstration to be held tomorrow. There were about 60 people in attendance at the meeting which started about 3:00 PM. These included BILL COATS, ALAN STANCLIFF, FREITJOF, THYGESON, GARY GULLEY, JACKQUELYNE TUMBURG, and a reverend from the Wesleyan Foundation.

There was a big hassle about the choice of the march route; the CMC wanted to march from Horton Plaza in downtown San Diego, along Broadway to the 11th Naval District Headquarters for some speeches and then to the old ferry landing for a rally.

SMS and the other students voted this down and CMC almost walked out. A long debate followed resulting considerable uneasiness between CMC and SMC. ALAN STANCLIFF was selected as monitor captain.

Afterwards, I went with BILL CLAY to Grossmont College where another anti-war rally was taking place and picked up some leaflets, which are attached.

We noted that they were passing out free food. BILL CLAY went and got some syringes and FRANK YACOPEC bought some pickles which were injected with rubbing alcohol and castor oil and were passed out to the students who were seen eating them. It is not noted if any of them became ill.

FRANK YACOPEC set fire to a trash can in a rest-room to cause a little extra excitement. After this, we drove by the People's Commune and saw three male individuals wearing Army helmets.

Jerome

Date prepared

Date received

Received from (name or symbol number)

Received by

5/11/70

50 1155 - [X] INFORMANT

SA Steven L. Christensen

Method of delivery (check appropriate blocks)

- in person
- by telephone
- by mail
- orally
- recording device
- written by Informant

If orally furnished and reduced to writing by Agent:
Date

Date of Report

Dictated _____ to _____

5/9/70

Transcribed _____

Date(s) of activity

Authenticated by Informant _____

5/9/70

Brief description of activity or material

Demonstrations, 5/70

File where original is located if not attached

* INDIVIDUALS DESIGNATED BY AN ASTERISK (*) ONLY ATTENDED A MEETING AND DID NOT ACTIVELY PARTICIPATE IN VIOLENCE OR REVOLUTIONARY ACTIVITIES WERE NOT DISCUSSED.

100 - 15071 - (Demonstrations, May, 1970)
170 - 256A - 17

100 - 14293 (Bill Clay)

100 - 14892 (M.D.M.)

100 - 12461 (M.M.)

100 - 13701 (Marcuse)

100 - 13375 (William Milson)

100 - 157787 (Warren Nielsen)

100 - 14862 (Coats)

100 - 14495 (Stanciff)

100 - 13697 (Shapiro)

100 - 13852 (Diepersloot)

157
~~138~~ - 891 (Breen)

100 - 17357 (J. Stuart Innerst)

100 - 14972 (C.M.C.)

100-15063 Index: Freitjof Thygeson; Peter Cartwright; Dr. George Abbott. 100-14159 T

Block Stamp

100 - 256A - 17

SEARCHED	INDEXED
SERIALIZED	FILED
JUN 9 1970	

Checked by [initials]

5/9/70
by Jerome

Today, approximately 5,000 people, mostly long hairs and hippies participated in an anti-war march and demonstration in San Diego. They marched from the downtown area to Balboa Park where a rally was held. It was noted that MDM marched as a separate unit in the demonstration and was trying to cause trouble.

BILL CLAY, who was present recognized two "long hair" Minutemen in the middle of the MDM group trying to rabble rouse. CLAY had mobilized between 100 and 200 right wing individuals and there appeared to be a lot of right wing agitation. There also appeared to be about the same number of Marines out waiting for a fight and several were seen in front of the Federal Building holding coke bottles and waiting for the hippies to come along.

I was told that the demonstration march was stopped at the 5th Avenue Bridge over Interstate Highway 5 and that BILL CLAY and his friends were the ones who stopped it.

BILL CLAY got into a discussion with FREITJOF THYGESON, who appeared to be very disgusted with the repetitive nature of the demonstration and the location of the march.

Persons observed present at the demonstration included HERBERT MARCUSE, BILL MILSON, WARREN NIELSEN, PETER CARTWRIGHT, BILL COATS and ALAN STANCLIFF.

SYLVIA SHAPIRO was the Master of Ceremonies and STUART INNERST was the main speaker. JAN DIEPERSLOOT and RON BREEN also spoke. Dr. GEORGE ABBOTT was also there and had organized an emergency medical corps using walkie-talkies and with ambulances available.

Sergeant BILL COOK of the La Mesa Police Department, and the Captain of the Security Guards at Convair (NFI) were there and were taking good photographs of the demonstration. It was learned that BILL CLAY "liberated" two rolls

Jerome

of exposed film from, someone participating in the demonstration.

It was noticed that apples and oranges were being passed out and afterwards the Minutemen made plans to load up some oranges with anti-freeze and donate them to the upcoming MDM rally at Oceanside.

Jerome

Date prepared

Date received

5/22/70

Received from (name or symbol number)

SD 1155 - INFORMANT

Received by

SA Steven L Christensen

Method of delivery (check appropriate blocks)

in person by telephone by mail orally recording device written by Informant

If orally furnished and reduced to writing by Agent:
Date

Dictated. _____ to _____

Transcribed _____

Authenticated
by Informant _____

Date of Report

5/22/70

Date(s) of activity

5/22/70

Brief description of activity or material

Information regarding
Arms Locker

File where original is located if not attached

170-286A

* INDIVIDUALS DESIGNATED BY AN ASTERISK (*) ONLY ATTENDED A MEETING AND DID NOT ACTIVELY PARTICIPATE. VIOLENCE OR REVOLUTIONARY ACTIVITIES WERE NOT DISCUSSED.

~~100-12401~~ (57-1148) (MM)
170-286A - 18
100-14293 (Clay)
100-14939 (John Bush)

Index: Arms Locker

Block Stamp

170-286A-18
SEARCHED JS INDEXED JS
SERIALIZED JS
JUN 15 1970
Christensen

MAY 22, 1970

BY JEROME

There is a new gun shop in El Cajon named the Arms Locker. It is located near the intersection of Main Street and 2nd Avenue. Both CLAY and some of the other Minutemen (MM) have been watching the place and say that a number of the leading Left Wing militants from the State College and other places around town frequent this-gun shop. I was also told that JOHN BUSH is a good friend of the owner of the Arms Locker. BUSH is known to be selling guns, ammunitions and other items to Leftis and colored militants and was a leading figure in a recent student demonstration at Grossmont College, although he is not a student there.

The Arms Locker is specializing in products of the Liberty Arms Company which are mostly small automatic pistols which sell for less than \$50.

Jerome

Date prepared

Date received

5/27/70

Received from (name or symbol number)

INFORMANT
SD 1155- [initials]

Received by

SA Steven L. Christensen

Method of delivery (check appropriate blocks)

in person by telephone by mail orally recording device written by Informant

If orally furnished and reduced to writing by Agent:

Date

Dictated _____ to _____

Transcribed _____

Authenticated by Informant _____

Date of Report

5/27/70

Date(s) of activity

5/23/70

Brief description of activity or material

Conversation with Bill Clay - new telephone information center at UCSJ

File where original is located if not attached

170-286A

* INDIVIDUALS DESIGNATED BY AN ASTERISK (*) ONLY ATTENDED A MEETING AND DID NOT ACTIVELY PARTICIPATE. VIOLENCE OR REVOLUTIONARY ACTIVITIES WERE NOT DISCUSSED.

100-14293 (Clay)

~~170-286A-19~~

100-14015 (Houghton)

100-14819 (Barry Godfrey)

100-14297 (Sam Davis)

100- (George Hoover) - Open Lead

100-157-1422 (Frank Yacopac)

100-157-1422 (Jerry Busch)

100-14556 (Peter Ruplinger)

Index: American Resistance Movement; EDNA to 170-286A

Block Stamp

170-286A-19

SEARCHED	INDEXED
SERIALIZED	FILED
JUN 15 1970	

[Signature]

MAY 27, 1970

BY JEROME

I was talking to BILL CLAY last Saturday. He seemed agitated and said he had needed to use a lot of caution. He said however, he wanted his name used and known as the local Minutemen (MM) leader and that he wanted this done to attract Federal attention in order to protect someone else in the background.

He is still talking about a new Right Wing organization and claimed to have contacts with groups in 11 western states and said these people are trying to establish a communications network and said the name American Resistance Movement (ARM) had been selected for this organization.

CLAY got to talking about DE PUGH and said he had been aware of DE PUGH's whereabouts when he was in hiding. He said he now has reason to believe TROY HOUGHTON may still be alive and probably connected with ARM. He said he believes HOUGHTON may have wanted out of the MM organization, for some reason, and had to disappear to do so.

CLAY also talked about setting up a meeting with the Leftist student group at University of California at San Diego during the regular week and he would like himself, BARRY GODFREY, SAM DAVIS, and GEORGE HOOVER to meet with four students from that group.

I have learned that HOOVER always carries a savage .380 pistol when he is away from home. DAVIS usually carries a .380 or .32 automatic pistol, CLAY usually has a .22 automatic pistol, FRANK YACOPEC always has a .32 MAB, "The Judge" (JERRY BUSH) usually has a .380 automatic pistol, and PETER RUPLINGER carries a .22 MAB.

ON MAY 26, 1970

BY JEROME

I have learned there is a new information center at UCSD, similar to Messenger Information Center. It has been in operation about two months and you reach it by dialing 453-EDNA. This information center is simply called EDNA.

Jerome

Date prepared

Date received

Received from (name or symbol number)

Received by

6/3/70

SDIISG-R

INFORMANT

SA Steven L. Christensen

Method of delivery (check appropriate blocks)

in person by telephone by mail orally recording device written by Informant

If orally furnished and reduced to writing by Agent: *

Date

Date of Report

Dictated _____ to _____

6/3/70

Transcribed _____

Date(s) of activity

Authenticated by Informant _____

6/3/70

Brief description of activity or material

Activities of Bill Clay, Barry Godfrey & George Hoover

File where original is located if not attached

170-286A

* INDIVIDUALS DESIGNATED BY AN ASTERISK (*) ONLY ATTENDED A MEETING AND DID NOT ACTIVELY PARTICIPATE. VIOLENCE OR REVOLUTIONARY ACTIVITIES WERE NOT DISCUSSED.

100-14293 (Clay)

170-286A-20

100-14819 (Godfrey)

100- (George Hoover)

100-157-1938 (Alden Edward Willis)

100-157-1830 (Frank Yacopac)

Block Stamp

170-286A-20
SEARCHED [initials] INDEXED [initials]
SERIALIZED [initials]
JUN 24 1970
Christensen

6/3/70

Jerome

It has been learned that BARRY GODFREY and FRANK YACOPEC are going to see BILL CLAY this morning at about 11:00 a.m. to listen to a right wing speaker at UCSD.

This Friday GODFREY is supposed to help CLAY move to his new apartment in Pacific Beach.

The photograph of ALDEN EDWARD WILLIS is not familiar, but the one of GEORGE HOOVER is. HOOVER previously had a goatee beard, but has now shaved it off. In person he looks much meaner and heavier than he appears in the photograph. He always has the same wide-eyed expression on his face.

It has been learned that BARRY GODFREY has been picked by the San Diego Fire Department to go to a school on bombs and explosives and he will probably be on the new fire department bomb disposal squad.

Jerome

Date prepared

Date received: 6/8/70
Received from (name or symbol number): INFORMANT [SP 1155 - A]
Received by: SA Steven L. Christensen

Method of delivery (check appropriate blocks)
 in person by telephone by mail orally recording device written by Informant

If orally furnished and reduced to writing by Agent:
Date _____
Dictated _____ to _____
Transcribed _____
Authenticated by Informant _____

Date of Report
6/8/70

Date(s) of activity
6/5/70

Brief description of activity or material
Clay moved to new apt. - cover-
sation w/ George Hoover -

File where original is located if not attached
170-286A

* INDIVIDUALS DESIGNATED BY AN ASTERISK (*) ONLY ATTENDED A MEETING AND DID NOT ACTIVELY PARTICIPATE. VIOLENCE OR REVOLUTIONARY ACTIVITIES WERE NOT DISCUSSED.

100-14293 (Bill Clay) Index: Jerry Tartaglia;
170-286A-21 Peter Cartwright, Orange
100-14819 (Godfrey) County True Press
100- (George Hoover) No 157-1798
100-14297 (Davis)
~~100-157-1935~~ (Alden Edward Willis) Paper filed
100-157-1870 (Frank Yacopac) in 170-286A
~~100-12461~~ (MM)
157-1798

Block Stamp

170-286A-21
SEARCHED 17 INDEXED 15
SERIALIZED 13
JUN 24 1970
Christensen

6/8/70

Jerome

It has been learned that with the help of BARRY GODFREY, BILL CLAY moved last Friday, June 5, to his new apartment at 4113 Ingraham, San Diego. This is supposed to be Ingraham Villa. No one is supposed to know about this address. CLAY had a large quantity of personal belongings and junk to move and has rented a garage near Second and Ivy (between Ivy and Juniper on the east side of Second there is a row of four garages and CLAY has the second from the left) where he is storing some of this stuff.

^{OLD} It was also learned that GEORGE HOOVER was at BILL CALY's ~~new~~ apartment Friday evening and was in a talkative mood as he was dead drunk. HOOVER apparently works at the same place as SAM DAVIS. HOOVER said DAVIS was recently in Texas on vacation and coming back his automobile broke down at Gila Bend, Arizona, and HOOVER had to go out there to assist him. Their boss at the fence company, is also supposed to be a Minutemen and HOOVER and DAVIS are probably getting some of their explosives from the fence company.

HOOVER now uses a .45 Automatic Pistol which he even takes to bed with him. He claimed his boss recently put up \$400 to get him out of some legal trouble.

HOOVER Said he had been living with a girl (NFI) who in the recent past, had walked out on him and had said she was going to contact the FBI. HOOVER seemed to be worried about this.

HOOVER was getting more drunk all the time and began rambling about "the ranch" where he lives. He said he had just moved out of the hotel into one of the smaller houses on the ranch. He kept talking about his horse and asked CLAY to call "WILLIE" at the ranch and ask him to feed the horse.

Jerome

HOOVER uses the nickname "Mick" and usually hangs out at the "341 Club" on Second Street in El Cajon. He also kept talking about a ROGER who went with him to get SAM DAVIS. This ROGER may live or work with HOOVER.

During the evening CLAY approached HOOVER about doing something to PETER CARTWRIGHT for spilling the beans on the undercover police officer named JOHN MURRAY.

It was also learned that many Minutemen, knowing that law enforcement officers are prone to handcuff people behind their backs, are now carrying handcuff keys attached to the inside rear waist band of their pants where they can avoid being detected in a frisk.

Attached is a copy of the May issue of a new newspaper named "The Orange County True Press" which is being printed by right wingers in the Santa Ana and Anaheim area. The names of these people appear in the newspaper. The paper was acquired from JERRY TARTAGLIO through FRANK YACOPEC.

Jerome

Date prepared

Date received

6/12/70

Received from (name or symbol number)

SD 1155-R

Received by

SA Steven L. Christensen

Method of delivery (check appropriate blocks)

in person by telephone by mail orally recording device written by Informant

If orally furnished and reduced to writing by Agent:

Date

Date of Report

6/12/70

Dictated _____ to _____

Transcribed _____

Authenticated by Informant _____

Date(s) of activity

6/12/70

Brief description of activity or material

Info re Bill Clay

File where original is located if not attached

170-286A

* INDIVIDUALS DESIGNATED BY AN ASTERISK (*) ONLY ATTENDED A MEETING AND DID NOT ACTIVELY PARTICIPATE. VIOLENCE OR REVOLUTIONARY ACTIVITIES WERE NOT DISCUSSED.

100-14293 (Clay)

170-286A-22

170-286A-22
Block Stamp

SEARCHED _____ INDEXED _____
SERIALIZED _____ JUN 24 1970
Christensen [initials]

6/12/70
JEROME

I have learned that BILL CLAY has been approached by a group of leftist students at University of California at San Diego who are allegedly fed up with the left wing tactics which have been used at University of California at San Diego and are supposed to want to form an alliance with right wing groups and individuals to deal with the Government. BILL CLAY seems to be enthusiastic about such an alliance as he feels there is a considerable amount of agreement between right and left wing groups as to the goals they would like to achieve and their general disillusionment with the Government and the established order. CLAY is giving the matter careful thought and may recontact this group of students at a future time.

Jerome

Date prepared

Date received

Received from (name or symbol number)

Received by

6/19/70

SD 1155-R [INFORMANT]

SA Steven L. Christensen

Method of delivery (check appropriate blocks)

in person by telephone by mail orally recording device written by Informant

If orally furnished and reduced to writing by Agent:

Date

Date of Report

Dictated _____ to _____

6/19/70

Transcribed _____

Date(s) of activity

Authenticated by Informant _____

6/19/70

Brief description of activity or material

Yippie Invasion of La Jolla

File where original is located if not attached

170-286A

* INDIVIDUALS DESIGNATED BY AN ASTERISK (*) ONLY ATTENDED A MEETING AND DID NOT ACTIVELY PARTICIPATE. VIOLENCE OR REVOLUTIONARY ACTIVITIES WERE NOT DISCUSSED.

100-0-14365 (Yippie Invasion of La Jolla)

170-286A-23

Block Stamp

170-286A-23

SEARCHED	INDEXED
SERIALIZED	FILED
JUN 21 1970	
Christensen	

6/19/70
JEROME

An acquaintance, ARTHUR HANSEN, told me today there is a house at 711 Fern Glen, La Jolla, about two houses from HANSEN's home which is occupied by "three weirdo men" who live there together. They have many stop signs, apparently stolen from intersections around town which they have nailed to the fence in their back yard. HANSEN said he recently observed one of these men in the back yard at 711 Fern Glen wearing a housecoat and a red wig.

HANSEN also told me that the night before the "pig invasion" of La Jolla, his sleep was disturbed by loud noises at approximately 3:00 a.m. and looking out his bedroom window he saw many cars arriving in front of the house at 711 Fern Glen to the point that the street was filled up with cars. He said each car carried two to five male individuals and he estimated a total of 50 to 60 people entered the house at 711 Fern Glen. HANSEN said he watched this incident until approximately 5:00 a.m. when he went back to bed and as yet none of the individuals had left the house. He said, however, when he awoke the next day the cars appeared to be gone. HANSEN thought this incident might have had some connection with the yippie invasion of La Jolla the following day.

Date prepared

7/13/70

Date received

7/2/70

Received from (name or symbol number)

SD 1155 - R INFORMANT

Received by

SA Steven L. Christen

Method of delivery (check appropriate blocks)

in person by telephone by mail orally recording device written by Informant

If orally furnished and reduced to writing by Agent: *

Date

Date of Report

7/2/70

Dictated _____ to _____

Date(s) of activity

7/2/70

Transcribed _____

Authenticated by Informant _____

Brief description of activity or material

Letters regarding "Weatherman" add in "Free Door."

File where original is located if not attached

170-286A

* INDIVIDUALS DESIGNATED BY AN ASTERISK (*) ONLY ATTENDED A MEETING AND DID NOT ACTIVELY PARTICIPATE. VIOLENCE OR REVOLUTIONARY ACTIVITIES WERE NOT DISCUSSED.

100-13474 (SDS)
170-286A-24
100-12461 (MM)
157-1798

Index: Tom Lineham
Maurice F. Cleary, Jr.
Robert Sullivan

170-286A-24
Block Stamp

SEARCHED _____ INDEXED _____
SERIALIZED _____ FILED _____
JUL 2 1970
FBI-SAN DIEGO
Christen

7/2/70
JEROME

Attached are three letters and envelopes which recently came to my attention. These letters are allegedly responses to an ad that appeared in the Free Door To Liberation for anyone interested in forming a local Weatherman group. These letters were supposedly obtained from the Free Door by the Minutemen and will have to be returned.

Jerome

I've been an SDS organizer
in Washington state and am
interested in finding a real
SDS chapter here. If you guys
are a bunch of dogmatic Leninists
don't bother to write back.
What colleges are you from?
What are your political
goals? No revolutionary class
'street fighting'. Only when it
is necessary - why do you
advertise for it? Do you
really go which way the wind
blowing? Like I said if
you're really an SDS
give me a reply.
Jerome

SDS
704 W. 7th
2221 Pine
S.D. 57107

2
2221 Abbott St.
San Diego, 92107

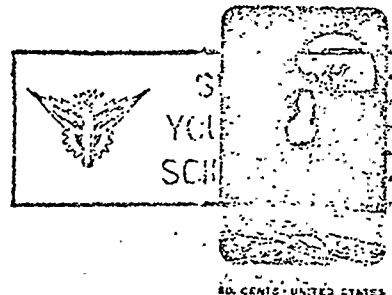

SDS
Free-Dawn Box 504
6389 Imperial Ave.
San Diego, CA
92114

To Whom It May Concern -

I saw your article in the Free Book
and I am writing to inquire about
more information. Please send it to
3959 Texax, San Diego, Calif. any information
you can give me will be greatly appreciated.

Thank You

Maurice F. Cleary Jr.

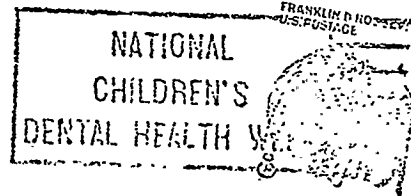

Free Book

Box 504

San Diego, Calif

NOT TO BE
REPRODUCED

9/2/14

Jerome

To whom it may concern,
I just came down to San Diego
after being sent to Patton State
Hospital for 9 months on false
charges concocted by certain people
from the establishment.

I would like you to send me
some information on SDS.

Here's my address:

Robert J. Sullivan

Apt. 27

7930 El Cajon Blvd.

La Mesa, Calif. 92041

AFTER 5 DAYS RETURN TO

Robert Sullivan

7930 El Cajon Blvd.

La Mesa, Calif. 92041
ZIP CODE

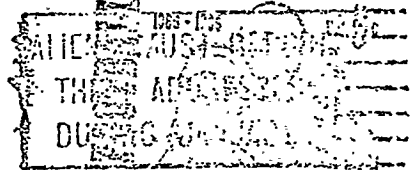

Weathermen SDS
Tree Looz
P.O. Box 504
San Diego, Calif.

12/14

Jerome

Date prepared

7/13/70

Date received

7/8/70

Received from (name or symbol number)

[SD 1155-R]

INFORMANT

Received by

SA Steven L. Christensen

Method of delivery (check appropriate blocks)

in person

by telephone

by mail

orally

recording device

written by Informant

If orally furnished and reduced to writing by Agent: +
Date

Dictated _____ to _____

Transcribed _____

Authenticated
by Informant _____

Date of Report

7/8/70

Date(s) of activity

7/6/70

Brief description of activity or material

Info re Jerry Geyer & Sam
Davis

File where original is located if not attached

170-286A

* INDIVIDUALS DESIGNATED BY AN ASTERISK (*) ONLY ATTENDED A MEETING AND DID NOT ACTIVELY PARTICIPATE.
VIOLENCE OR REVOLUTIONARY ACTIVITIES WERE NOT DISCUSSED.

100- (Jerry Geyer)
~~170-286A - 25~~
100-14297 (Davis)

Block Stamp

170-286A-25

SEARCHED	INDEXED
SERIALIZED	FILED
JUL 17 1970	

REPORT BY JEROME
On July 8, 1970

I was at JERRY GEYER's house on the evening of July 6, 1970. GEYER said he was given some gun parts by a person named "DOC" who is an ex-serviceman and a friend of LYLE MANNING. GEYER said according to DOC, these parts belonged to SAM DAVIS and SAM was suppose to get in touch with him later about the parts. The parts are for a World War II German automatic assault rifle and are illegal to own. GEYER said following this a person who gave his name as SAM WILLIAMS called on the telephone and asked about some other gun parts. GEYER recognized the voice, however as being that of SAM DAVIS and GEYER is now suspicious of DAVIS because he does not know what he is up to. He said DAVIS was looking around for 50 M-2 Trip Levers.

It has been rumored DAVIS is paying high prices for guns and gun parts but is selling low to TOM FORREST. FORREST is the biggest gun dealer in town.

Jerome

Date prepared

8/13/70

Date received

8/8/70

Received from (name or symbol number)

SD 1185 - B

INFORMANT

Received by

SA Steven L. Christensen

Method of delivery (check appropriate blocks)

in person by telephone by mail orally recording device written by Informant

If orally furnished and reduced to writing by Agent:
 Date

Dictated _____ to _____

Transcribed _____

Authenticated by Informant _____

Date of Report

8/8/70

Date(s) of activity

8/6/70

Brief description of activity or material

National Yippie Day at
Disneyland

File where original is located if not attached

170-286A

* INDIVIDUALS DESIGNATED BY AN ASTERISK (*) ONLY ATTENDED A MEETING AND DID NOT ACTIVELY PARTICIPATE. VIOLENCE OR REVOLUTIONARY ACTIVITIES WERE NOT DISCUSSED.

100-152821 (National Yippie Day at
Disneyland, 8/6/70)

170-286A - info

100-1571521 (Frank Yacopiec)

Block Stamp

170-286A-26
SEARCHED INDEXED
SERIALIZED
AUG 14 1970
FBI

REPORT BY JEROME
On August 7, 1970.

Yesterday, August 6, 1970, I went to watch the National Yippie Day at Disneyland. Many long hairs and hippie type people were at the gate and parking lot all day long but there were never enough there at one time to make a big crowd and most left after milling around for a while. It appeared that they just did not have enough money to get in.

FRANK YACOPEC, JERRY TARTAGLIO and others got in using Press Cards from the Anaheim Bulletin. Also there was EUGENE BROWN from the Orange County True Press, STEVE FRANKS from VIVA and many other right wingers from the Orange County area. The group took several hundred photographs and shot two rolls of movie films.

The only serious incident occurred at about 6:30 p.m., when 300 or 400 yippies got together and started marching from place to place in Disneyland. There were several scuffles with the police who were called in at about 7:00 p.m., and one girl was yelling "Kill the Pig, Kill the Pig."

The yippies made an attempt to tear down the flag in the fort but JERRY TARTAGLIO and "CHUCK" stood against the flag pole and stopped them.

One of the apparent leaders of the yippies was about 45 years old with long hair and beads. He got into a scuffle with the police and a cop grabbed him by the hair, which came right off showing him to be very bald.

It looked to me as if there would have been serious trouble if the yippies had been able to get a few more people in there. However, they backed right down when they were confronted by the police. A lot of threats were made and obscenity used.

During the day I noted about six yippies in front of the gate with 15 - 20 ticket books passing out tickets to other yippies to get in. Someone put out a lot of money for a lot of yippies to get in.

Jerome

After the yippies were thrown out, there was some rock throwing at the gate and an attempted march on the Disneyland Hotel which the police broke up. It was later announced that people with long hair would no longer be allowed admittance into Disneyland.

Jerome

Date prepared
8/13/70

Date received: 8/10/70
Received from (name or symbol number): [SD 1155-R] INFORMANT
Received by: SA Steven H. Christensen

Method of delivery (check appropriate blocks)
 in person by telephone by mail orally recording device written by Informant

If orally furnished and reduced to writing by Agent:
Date _____
Dictated _____ to _____
Transcribed _____
Authenticated by Informant _____

Date of Report
8/10/70

Date(s) of activity
8/9/70

Brief description of activity or material
Info re Peter Ruffinger, Leon Newer
MM Org., Bill Clay

File where original is located if not attached
170-286A

* INDIVIDUALS DESIGNATED BY AN ASTERISK (*) ONLY ATTENDED A MEETING AND DID NOT ACTIVELY PARTICIPATE. VIOLENCE OR REVOLUTIONARY ACTIVITIES WERE NOT DISCUSSED.

- 100-14351 (Peter Ruffinger) Index: (To AVG) ^{Laurence Norton} Orange County True Press; John Zernango
- 170-286A-2
- 157-594 (Newer) Lloyd Pullen; STAFF
- 100-14541 (American Volunteer Group) Glen Jackson; Jerry Tartaglio; Eugene Brough; VIVVA
- 100-157-1571 (Frank Yacopac)
- 100-14293 (Bill Clay) (To Peter Ruffinger)
- 100-14819 (Barney Godfrey) ^{World Identity Informant} Jim Westwood; Fred Akers
- 100-13674 (Jim Westwood)
- 100-15133 (Jerry Tartaglio)

Block Stamp

170-286A-27
SEARCHED [] INDEXED []
SERIALIZED [] FILED []
AUG 14 1970
FBI - []
[]

REPORT BY JEROME
On August 10, 1970

would identify ANOTHER INFORMANT

I was talking to PETER RUPLINGER yesterday. He said his cousin, JIM WESTWOOD, use to work for the FBI in San Diego as an informer. According to PETER, WESTWOOD lives on Seventh Avenue near Balboa Park. He said that WESTWOOD told him that he heard strange noises in front of his house a couple of nights ago, and went to the front door to see what was going on. He said he saw Professor LEON NOWER, apparently very drunk, fooling around with WESTWOOD's automobile. WESTWOOD asked NOWER what he was doing and what he wanted and NOWER said he was looking for a girl and asked if she lived in any of the houses nearby. No one knew why NOWER was actually there.

There is much antagonism between the right wing group in San Diego and Los Angeles. The Orange County True Press has ~~been~~ ^{disintegrated}. Some of the Los Angeles groups are trying to dis-credit FRANK YACOPEC, who was working on the paper and have made JERRY TARTAGLIO mad at him. It looks like JOHN ZEMANEC of AVG and LLOYD PULLEN of STAFF are trying to move in on the Orange County True Press. Those two and GLEN JACKSON of the National Patriotic Party and LAWRENCE NORTON connected with the Minute-men and AVG were at a meeting with JERRY TARTAGLIO at two o'clock in the morning last week and apparently want to stop all right wing activity in San Diego.

I was told that EUGENE BROWN, editor of the Orange County True Press and TARTAGLIO have been trying to get FRANK YACOPEC and BARRY GODFREY's address in San Diego.

VIVA is a front group for ED BUTLER who puts out the Orange County True Press. Attached are copies of the June and July 1970 issues of the paper.

I was talking to BILL CLAY this morning about the situation and he suggested trying to push the San Diego Minute-men organization in Orange County. He was talking about setting up a mail drop in Yuma or Phoenix, Arizona.

Jerome

~~XXXXXXXXXX~~ PETER RUPLINGER is presently living with Professor FRED AKERS at 5137 Rincon Street, San Diego, California. He has made contact with an organization of right wing professors at San Diego State College who have gotten together to try and do something about the situation on college campuses. He thinks there may be a similar group at the University of California at San Diego.

Jerome

Date prepared,

8/24/70

Date received

8/17/70

Received from (name or symbol number)

SD 1153-R INFORMANT

Received by

SA Steven L. Christensen

Method of delivery (check appropriate blocks)

in person by telephone by mail orally recording device written by Informant

If orally furnished and reduced to writing by Agent:
Date

Date of Report

8/17/70

Dictated _____ to _____

Date(s) of activity

8/16/70

Transcribed _____

Authenticated by Informant _____

Brief description of activity or material

Info re Street Journal Benefit 8/16/70
Glenn Moore possible source at
SDSC

File where original is located if not attached

170-286A

* INDIVIDUALS DESIGNATED BY AN ASTERISK (*) ONLY ATTENDED A MEETING AND DID NOT ACTIVELY PARTICIPATE. VIOLENCE OR REVOLUTIONARY ACTIVITIES WERE NOT DISCUSSED

100-14376 (St. Journal)

Index: Glenn Moore to

~~170-286A-287~~

~~100-157-2920 (Frank Yacofec)~~

would identify possible source

100-14829 (Barry Godfrey)

Block Stamp

170-286A-28

SEARCHED	INDEXED
SERIALIZED	FILED
AUG 25 1970	

Christensen

REPORT BY JEROME
On August 17, 1970

I stopped and watched the White Whale for about a half of an hour last night at 9:00 p.m. The benefit for the San Diego Street Journal was in full swing and I saw 30 - 40 long hair hippie types outside. Someone apparently turned in a false fire alarm at the White Whale as three fire trucks and several police cars came screaming up. After that there were a lot of people milling around the White Whale and I had to leave. FRANK YACOPEC was also there watching.

would identify possible source
A person who might be a good source of information is GLENN MOORE. He was recently divorced from his wife and now lives in Pacific Beach. He has telephone number 274-9720. He will be attending San Diego State College this Fall and will work nights at the Telephone Company. He might be very useful. He is the one who messed up the Message Information Center Telephones during the November 15, 1969, Anti-war demonstrations. He is very anti-left.

It might be best to approach him saying that BARRY GODFREY had referred him to us as a possible source of information at State College.

Jerome

Date prepared

9/1/70

Date received

8/25/70

Received from (name or symbol number)

SD 1155-R

INFORMANT

Received by

SA Steven H. Christensen

Method of delivery (check appropriate blocks)

in person by telephone by mail orally recording device written by Informant

If orally-furnished and reduced to writing by Agent:

Date

Dictated _____ to _____

Transcribed _____

Authenticated by Informant _____

Brief description of activity or material

Info re Region of Justice

Date of Report

8/25/70

Date(s) of activity

8/25/70

File where original is located if not attached

170-286A

* INDIVIDUALS DESIGNATED BY AN ASTERISK (*) ONLY ATTENDED A MEETING AND DID NOT ACTIVELY PARTICIPATE. VIOLENCE OR REVOLUTIONARY ACTIVITIES WERE NOT DISCUSSED.

Information recorded on a card index by _____ on date _____

Remarks:

176-1-5 (Region of Justice)
176-6j
170-286A-29
100-14293 (Clay)

170-286A-29
Block Stamp

SEARCHED INDEXED
SERIALIZED 7/11/70
SEP 3 1970

REPORT BY JEROME
August 25, 1970

The name Legion of Justice is not familiar to me and neither are the names of BUCKMAN, STEWART, or ARTHUR who are suppose to be connected with it. BILL CLAY does have a Post Office Box in his name at La Mesa and he may possibly be BUCKMAN. CLAY said at one time that some strange mail might show up in the La Mesa Post Office Box and if so to save it for him.

To the best of my knowledge, Mr. BUCKMAN who runs Buckman's Gun Shop on University is a nice old fellow but may have some right wing leanings. He has a son who runs an appliance store near the Gun Shop who is definitely right wing and very wild.

Jerome

Date prepared

9/1/70

Date received

8/24/70

Received from (name or symbol number)

SD 1155-R

INFORMANT

Received by

SA Steven L. Christensen

Method of delivery (check appropriate blocks)

in person by telephone by mail orally recording device written by Informant

If orally furnished and reduced to writing by Agent:
Date

Dictated _____ to _____

Transcribed _____

Authenticated by Informant _____

Date of Report

8/24/70

Date(s) of activity

8/21+22/70

Brief description of activity or material

Activities of Peter Ruffinger,
Bill Clay + Jerry Geyer

File where original is located if not attached

170-286A

* INDIVIDUALS DESIGNATED BY AN ASTERISK (*) ONLY ATTENDED A MEETING AND DID NOT ACTIVELY PARTICIPATE. VIOLENCE OR REVOLUTIONARY ACTIVITIES WERE NOT DISCUSSED.

Information recorded on a card index by _____ on date _____

Remarks:

100-14356 (Peter Ruffinger)
170-286A-30
100-17461 (MM)
100-14293 (Clay)
100- (Jerry Geyer) open book

Block Stamp

170-286A-30
SEARCHED INDEXED
SERIALIZED SEP 3 1970
Christensen

REPORT BY JEROME

August 24, 1970

would identify another informant

I saw PETER RUPLINGER last Saturday. He insisted that his cousin, JIM WESTWOOD, once worked for the FBI as an informer. He said WESTWOOD told him the FBI had asked about him, PETER, but said nothing more to him except the FBI was thinking about contacting him as a source.

PETER said if the FBI did not hurry in contacting him, he would contact the FBI as he wants to become an Agent when he graduates from school.

The Minute-men at San Diego have put out a bunch of new stickers (one is attached). The La Mesa Post Office Box number on the sticker is listed to BILL CLAY, with whom I talked on Friday. He said that he does not want to be contacted by right wingers in the San Diego area, except in an emergency because he does not want to be connected with the new stickers. He thinks the FBI will be around to see him about the stickers anyway.

I do not know what CLAY is up to. It may be he is trying to separate himself from local right wing activities or possibly he is trying to decoy attention away from people involved in local Minute-men activities. I still get the feeling CLAY is involved in something big and is trying to get some organization going in several states.

I also stopped off at JERRY GEYER's house Friday evening and saw a big tripod mounted World War II German machine gun. He also had all of the grease gun parts laying around and had a case of a dozen timing devices for artillery shells.

Jerome



"MINUTEMEN"

WRITE AFC
P. O. 3366
LA MESA CALIF.

UNITED STATES GOVERNMENT

Memorandum

TO : SAC, SAN DIEGO

DATE: 9/3/70

FROM : SA C. JORDAN NAYLOR (170-286)

SUBJECT: SD 1155-R INFORMANT.

At 8:30 a.m. on 9/3/70, informant advised he had received the following information relative to President NIXON's visit to Coronado on this date:

LILA BUCK and a group of approximately 50 "right-wingers" have organized themselves and plan to meet on the corner of 12th Street and Orange Street, Coronado, between 9:00 and 10:00 a.m., 9/3/70, to attract attention regarding their protest because President NIXON has refused to see Reverend MC INTYRE (phonetic). Specific plans of the group are unknown except for the fact they plan to attract the President's attention to the Reverend MC INTYRE matter. Further details unknown.

The Message Information Center, telephone number 232-6621, has been encouraging all "left wingers" to meet in front of the Del Coronado Hotel between 9:00 and 11:00 a.m. on 9/3/70. A cadre has been organized to walk through the crowd to attempt to stir up trouble. This is to occur in connection with the "yippie dope-in," which is to occur during the day.

Informant said he will be attending activities at Coronado during the day and will immediately contact Agent NAYLOR or Agent CHRISTENSEN to furnish details of any demonstrations which come to his attention.

- ① - 170-286 *A*
- 1 - 100-15317
- 1 - 105-7373

CJN:mt
(3)

*Agent Christensen
A. B. [unclear]*

31

170-286A-*31*

SEARCHED	INDEXED
SERIALIZED	FILED
FBI - SAN DIEGO	

fl

Date prepared

9/2/70

Date received

8/27/70

Received from (name or symbol number)

SD 1155-R ^{INFORMANT}

Received by

SA Steven Christensen

Method of delivery (check appropriate blocks)

in person by telephone by mail orally recording device written by Informant

If orally furnished and reduced to writing by Agent:

Date

Date of Report

8/27/70

Dictated _____ to _____

Date(s) of activity

8/27/70

Transcribed _____

Authenticated by Informant _____

Brief description of activity or material

Info re AVG

File where original is located if not attached

170-286A

* INDIVIDUALS DESIGNATED BY AN ASTERISK (*) ONLY ATTENDED A MEETING AND DID NOT ACTIVELY PARTICIPATE. VIOLENCE OR REVOLUTIONARY ACTIVITIES WERE NOT DISCUSSED.

Information recorded on a card index by _____ on date _____

Remarks:

100-14541 (American Volunteer Group)

170-286A-32

100-14301 (Paul Ruplinger)

100-14293 (Clay)

~~100-12464~~ (M/M)

157-1798

Index: William Lem Lee
Medric "Bud" Johnson
John Zemanec
Helen Grant
Frank Capelo
to AVG

Block Stamp

170-286A-32

SEARCHED INDEXED
SERIALIZED
SEP 3 1970
FBI - MEMPHIS

Christensen

REPORT BY JEROME
August 27, 1970

This morning I was talking to General WILLIAM LEMLY who lives at 1536 Glorietta Place, Coronado. He claimed to have been part of a Military underground organization since 1927, which was strong because of fears in the Military of Communist takeover in this country.

He told me that AVG actually stands for American Volunteer Government. He explained that later on the organization felt a need for an above-ground front organization and so established the American Volunteer Group, with MEDRIC "BUD" JOHNSON as the leader and with an Advisory Council of 13 Military officers. These included Commander BALDORF who refused to go to Vietnam because the Government would not fight to win, General "CHESTY" PULLER, General CUSTIS LE MAY, and others.

According to LEMLY, membership in American Volunteer Groups was to be opened to civilians but restricted only to those referred to the organization by the Military Council and those who were already members.

When "BUD" JOHNSON died, under mysterious circumstances, JOHN ZEMANEC and his secretary, HELEN GRANT, took over. ZEMANEC and GRANT then threw the membership open to the general public upon which the Military Council dropped out, and as far as the Military is concerned, that part of AVG is now defunct.

LEMLY told me that the name A. DUNN which appears on old AVG bulletins and letterhead stationery is a pseudonym for a woman from Seattle. He said she is an agent for a private investigative group which has its headquarters on the east coast. This investigative group is run by a former FBI Agent named FRANK CAPELO (phonetic) and investigates left wing activities.

CAPELO is suppose to be in the San Diego area in the near future, and LEMLY said he would refer me to him for possible employment as an Agent on the west coast.

Jerome

LEMELY claimed that he and ROBERT WELSH, leader of the John Birch Society are good friends and communicate frequently. LEMELY claimed that he is Vice-President of the National Liberty Amendment Committee, which is a front group for the John Birch Society. The Liberty Amendment represents the elimination of income tax and LEMELY claimed he was testifying last week before a California State Senate Group about the amendment.

I saw LEMELY on PAUL RUPLINGER's recommendation. LEMELY claimed he and PAUL RUPLINGER are also good friends. LEMELY again talked about the American Volunteer Government and said the purpose of the organization is to bring about a Military coup in this country if it becomes necessary. He said the organization's headquarters are located in or near Washington, D.C.

LEMELY said that JOHN ZEMANEC was formerly Chief of Security of the above ground organization under JOHNSON and his secretary, HELEN GRANT, was suppose to be a teacher but LEMELY's group was never able to verify this. LEMELY said that because of the peculiar circumstances surrounding JOHNSON's death, his group did a little investigating and found that ZEMANEC was a Long Shorman and belonged to HARRY BRIDGES Long Shorman Union. LEMELY said that ZEMANEC might actually have been a left wing infiltrator.

LEMELY appeared to be very Military, anti-left and pro-minute-men and may form an alliance with the Minute-men in this area.

LEMELY who was in ONI for several years, also claimed to have access to Canadian and British Intelligence Reports from all over the world, through a friend who is still in Washington, D.C.

After talking to LEMELY, I saw BILL CLAY who told me that he is now working in some big national movement and can no longer spare the time to be deeply involved in local Minute-men activities.

Jerome

CLAY passed on to me all of the stuff he had been using including blank Birth and Marriage Certificates, Selective Service Registration cards, Social Security Application forms, Letterhead Stationery from many companies around the country, FBI Letterhead Stationery, forms to fill out showing receipt of Marine Corps Good Conduct Medals. He also gave me a plate burner for making stencils for an off set press.

CLAY said he would continue to give local Minute-men any help and support necessary both here and in other places and said he would set up a Post Office Box in Las Vegas for the local Minute-Men group.

Perome

Date prepared

9/8/70

Date received

8/31/70

Received from (name or symbol number)

[SD 1155-R] INFORMANT

Received by

SA Steven L. Christense

Method of delivery (check appropriate blocks)

in person by telephone by mail orally recording device written by Informant

If orally furnished and reduced to writing by Agent:
Date

Dictated _____ to _____

Transcribed _____

Authenticated by Informant _____

Date of Report

8/31/70

Date(s) of activity

8/31/70

Brief description of activity or material

Info re Free Door, Sunrise + AVG

File where original is located if not attached

170-286 A

* INDIVIDUALS DESIGNATED BY AN ASTERISK (*) ONLY ATTENDED A MEETING AND DID NOT ACTIVELY PARTICIPATE. VIOLENCE OR REVOLUTIONARY ACTIVITIES WERE NOT DISCUSSED.

Information recorded on a card index by _____ on date _____

Remarks:

100-14948 (Free Door)

170-286A-33

100-15712 (Sunrise)

100-14541 (AVG)

~~100-12461~~ (MM)

157-1796

Index: (to AVG) General William Lemley; John Czernanec

Block Stamp

170-286A-33

SEARCHED	INDEXED
SERIALIZED	FILED
SEP 14 1970	
FBI - SAN DIEGO	

[Signature]

REPORT BY JEROME
August 31, 1970

I found out this morning in talking with DALE HERSCHLER that the manager of Les Girls who was supporting the Free Door financially backed out two weeks ago and the paper is now in trouble. For the first time the Door is planning to charge for the newspaper, they still may not have enough money to print it. They have decided to stop carrying sex oriented adds in the paper.

I also learned that the Sunrise newspaper lost at least \$8,000 on the rock concert it sponsored and does not have enough money to go on printing.

I talked to General LEMLY of AVG again who told me that "BUD" JOHNSON, former leader of AVG, was in the process of putting together a big expose on the Communist Party in the United States at the time of his death. LEMLY said JOHNSON was getting his information from a former Military Intelligence Officer who was also connected with AVG. LEMLY said he and other officers in the Military part of AVG suspect JOHN ZEMANEC may have had JOHNSON done in and the Military part of AVG is out to get ZEMANEC and the civilian AVG organization if they can.

LEMLY claimed he and some right wing friends were responsible for putting together and passing out the leaflets announcing the Yippie Pig National Invasion of La Jolla early in the summer. LEMLY said although they did not think anything would actually happen, it turned out better than expected as many La Jollans were turned against the left and have indicated support for right wing activities.

The new Minute-men stickers were printed at Alex Rapid Print in La Mesa, California.

Jerome

Date prepared

9/8/70

Date received

9/2/70

Received from (name or symbol number)

SD 1155-R INFORMANTS

Received by

Steven L. Christensen

Method of delivery (check appropriate blocks)

in person by telephone by mail orally recording device written by Informant

If orally furnished and reduced to writing by Agent:

Date

Date of Report

9/2/70

Dictated _____ to _____

Date(s) of activity

9/2/70

Transcribed _____

Authenticated by Informant _____

Brief description of activity or material

Info re MIC & President
Nixon visit 9/3/70

File where original is located if not attached

170-286A

* INDIVIDUALS DESIGNATED BY AN ASTERISK (*) ONLY ATTENDED A MEETING AND DID NOT ACTIVELY PARTICIPATE. VIOLENCE OR REVOLUTIONARY ACTIVITIES WERE NOT DISCUSSED.

Information recorded on a card index by _____ on date _____

Remarks:

100-14427 (MIC)

170-286A-34

100-15317 (Nixon Visit)

100-17079 (John Birch Society)

Block Stamp

170-286A-34

SEARCHED	INDEXED
SERIALIZED	
SEP 14 1970	
FBI - [unclear]	

[Signature]

REPORT BY JEROME
September 2, 1970

I learned this afternoon from Message Information Center that an unidentified group of individuals in the San Diego area is preparing for a large scale anti-Vietnam war demonstration tomorrow during the festivities surrounding the visit and State dinner of Presidents NIXON and ORDAZ. Apparently this demonstration is separate and apart from the previously announced "Yippie Dope-In" at Coronado, California, tomorrow.

According to MIC plans for the demonstration call for participants to gather in the Hotel Del Coronado parking lot for a rally and march beginning at 9:00 A.M.

I have also learned that a large number of right wing oriented individuals mostly older female members of the John Birch Society will also be present in Coronado tomorrow to carry signs and protest against left wing groups.

Date prepared

9/14/70

Date received

9/4/70

Received from (name or symbol number)

SD 1155-R INFORMANT

Received by

SA Steven L. Christensen

Method of delivery (check appropriate blocks)

in person by telephone by mail orally recording device written by Informant

If orally furnished and reduced to writing by Agent:
Date

Dictated _____ to _____

Transcribed _____

Authenticated by Informant _____

Date of Report

9/4/70

Date(s) of activity

9/3/70

Brief description of activity or material

Info re visit of Pres. Nixon to Colorado

File where original is located if not attached

190-286A

* INDIVIDUALS DESIGNATED BY AN ASTERISK (*) ONLY ATTENDED A MEETING AND DID NOT ACTIVELY PARTICIPATE. VIOLENCE OR REVOLUTIONARY ACTIVITIES WERE NOT DISCUSSED.

Information recorded on a card index by _____ on date _____

Remarks:

100-15317 (Nixon Visit) Index: Cal. Lib. KMY 364,
190-286A-35 Bonnie Anderson
100-14356 (Peter Kaufinger)
100-14075 (Lowell Bergman)
157-800 (Dale Henschler)
100-14376 (St. Journal)

190-286A-35
Block Stamp

SEARCHED INDEXED
SERIALIZED
SEP 15 1970
FBI - [unclear]

REPORT BY JEROME
On September 4, 1970

I went over to Coronado yesterday to watch the parade in honor of President NIXON and President ORDAZ and while there I noticed six suspicious male individuals, three colored, two white and one Mexican. They were roaming through the crowds trying to agitate and stir people up. I followed them to the Del Coronado Hotel. They finally got into a Pontiac with California license KMY 364 and I saw one or two rifles in the car. I immediately contacted a California Highway Patrol Officer who put this information out on his car radio.

According to PETER RUPLINGER, who was with me, he previously observed one of these Negro males acting as Master of Ceremonies when ABBY HOFFMAN appeared at San Diego State College to speak several months ago.

I observed the following persons at the parade:

BONNIE ANDERSON, a white girl who is believed to be connected with the Progressive Labor Party.

Several unidentified leaders of the Chicano Moratorium March at Los Angeles who were asking for contributions for bail for the Chicanos arrested in Los Angeles.

DALE HERSCHLER, former editor of the Door.

LOWELL BERGMAN of the San Diego Street Journal.

The orange bus which the Street Journal used last year was also there.

A number of right wingers, 19 - 20, mostly older women carrying signs which said "March for victory at Washington, C.D., on October 3, 1970".

Jerome

Date prepared

9/14/70

Date received

9/8/70

Received from (name or symbol number)

SD 1155-R INFORMANT

Received by

SA Steven L. Christensen

Method of delivery (check appropriate blocks)

in person by telephone by mail orally recording device written by Informant

If orally furnished and reduced to writing by Agent: Date

Date of Report

9/8/70

Dictated _____ to _____

Date(s) of activity

9/8/70

Transcribed _____

Authenticated by Informant 10/

Brief description of activity or material

Info re activities of Peter & Paul Ruplinger

File where original is located if not attached

170-286A

* INDIVIDUALS DESIGNATED BY AN ASTERISK (*) ONLY ATTENDED A MEETING AND DID NOT ACTIVELY PARTICIPATE. VIOLENCE OR REVOLUTIONARY ACTIVITIES WERE NOT DISCUSSED.

Information recorded on a-card index by _____ on date _____

Remarks:

100-143576 (Peter Ruplinger)
170-286A - 36

Index: Don Freedman
Travis Jackson
R. J. Work

~~100-1571570~~ (Frank Yacofec) 100-14350
100-14819 (Barry Godfrey)
100-14301 (Paul Ruplinger)
100-11836 (YSA)

Block Stamp

170-286A-36

SEARCHED	INDEXED
SERIALIZED	
SEP 15 1970	

Christensen

REPORT BY JEROME
On September 8, 1970

I was talking to PETER RUPLINGER this morning and he told me about DEPUGH holding some of the people in cages when he was captured by the FBI.

PETER is no longer living with Professor FRED AKERS and has temporarily rented an apartment in El Cajon using the name DON FREEDMAN. He is going to try to rent one or two Post Office Boxes using that name.

PETER is suppose to get married October 23, 1970, and will then rent an apartment in his own name.

PETER told me that he, FRANK YACOPEC and BARRY GODFREY had a meeting to make out future right wing strategy. It was decided that they would continue to harassing left wing individual and organizations but would avoid hurting anyone or getting involved in any real violence. PETER said that he made contact with a person named "TRAVIS" who he said is a lefty but who he is converting. PETER said TRAVIS told him on September 3, 1970, about a person named R. J. WORK, who lives on Lincoln Avenue who had infiltrated activities for the left.

He also told me about an individual at the University of California at San Diego where a construction worker dropped a five gallon bucket of tar from the fifth floor of the new hospital building into a group of hippies. Apparently the bucket of tar broke and sprayed all over the hippies.

PAUL
PETER RUPLINGER, posing as a prospective buyer, went to the house at 1362 Union Street, San Diego, California, on September 2, 1970. He said he found the place was divided into four apartments, some of which he did not see. He said he observed nothing which might possibly have been connected with YSA and added that the landlady told him she had just told the tenants to get out of one of the apartments and had re-rented it.

TRAVIS IS TRAVIS JACKSON

Jerome

Date prepared
9/14/70

Date received
9/9/70

Received from (name or symbol number)
S.D. 1155 - ~~REINFORMANT~~

Received by
S.A. Steven L. Christensen

Method of delivery (check appropriate blocks)
 in person by telephone by mail orally recording device written by Informant

If orally furnished and reduced to writing by Agent:
Date

Date of Report
9/9/70

Dictated _____ to _____

Date(s) of activity

Transcribed _____

9/9/70

Authenticated by Informant 10/9/70

Brief description of activity or material
Info re Bill Clay + NMM

File where original is located if not attached
170-286A

* INDIVIDUALS DESIGNATED BY AN ASTERISK (*) ONLY ATTENDED A MEETING AND DID NOT ACTIVELY PARTICIPATE. VIOLENCE OR REVOLUTIONARY ACTIVITIES WERE NOT DISCUSSED.

Information recorded on a card index by _____ on date _____

Remarks:

100-14293 (Clay)
170-286A - 37
~~100-12461 (NMM)~~
151-1798

Block Stamp

170-286A-37
SEARCHED INDEXED
SERIALIZED
SEP 15 1970
Christensen

REPORT BY JEROME
September 9, 1970

I saw BILL CLAY this morning and received from him negatives and other material for making phony draft cards, Selective Service Cards, California State Birth Certificates, Missouri and California Drivers Licenses and many other papers for making phony identifications.

CLAY again said he is trying to do some work on a nation wide movement.

The Minutemen are very interested in finding out if Mecha-Maya and the black students council at San Diego State College are still to get the proceeds from the first to home football games which San Diego State College prays.

CLAY also asked me to get a new Post Office Box for him which I agreed to do and I will furnish the combination and number as soon as I get it.

Jerome

Date prepared

9/23/70

Date received

9/17/70

Received from (name or symbol number)

SD 1155-R INFORMANT

Received by

SA Steven L. Christensen

Method of delivery (check appropriate blocks)

in person by telephone by mail orally recording device written by Informant

If orally furnished and reduced to writing by Agent:
Date

Dictated _____ to _____

Transcribed _____

Authenticated by Informant 10/9/70

Date of Report

9/17/70

Date(s) of activity

9/17/70

Brief description of activity or material

Info re MIC

File where original is located if not attached

170-286A

* INDIVIDUALS DESIGNATED BY AN ASTERISK (*) ONLY ATTENDED A MEETING AND DID NOT ACTIVELY PARTICIPATE. VIOLENCE OR REVOLUTIONARY ACTIVITIES WERE NOT DISCUSSED.

Information recorded on a card index by _____ on date _____

Remarks:

100-14427 (MIC)

170-286A-38

157-594 (Nover)

100-14892 (MDM)

100- dead (Phil Plymate)

100- (New Adult Community) m.c.s. info
- dead if no file

Block Stamp 170-286A-38

SEARCHED INDEXED
SERIALIZED SEP 25 1970
[Signature]

REPORT BY JEROME
September 17, 1970

I have learned that Message Information Center has a comline or telephone extension to New ~~Educational~~ *Adult* Community at 1924 Island. MIC has a three digit rotary switch board and gets an extremely large number of calls every day.

The head operator and the person who apparently runs MIC is named PHIL PLYMATE. However, it looks to me as though MIC is completely controled and directed by New Educational Community.

I have learned that the keys to the MIC Office are kept at 1924 Island. MIC is in operation every day from 9:00 A.M., till midnight.

Last night I tried to call LEON NOWER at his home at about 11:00 P.M.; a babysitter answered the phone and said he was not home, but in an emergency could be reached at 443-5869, or at 442-2163.

While I was at MIC today I learned that MDM had a new telephone installed today which is 234-1190, and which is supposed to be kept confidential

Jerome

Date prepared

9/23/70

Date received

9/18/70

Received from (name or symbol number)

SA Steven L. Christensen

Received by

SA Steven L. Christensen

Method of delivery (check appropriate blocks)

in person by telephone by mail orally recording device written by Informant

If orally furnished and reduced to writing by Agent:

Date

Dictated _____ to _____

Transcribed _____

Authenticated by Informant _____

Date of Report

9/18/70

Date(s) of activity

9/18/70

Brief description of activity or material

Info re MIC

File where original is located if not attached

170-286A

* INDIVIDUALS DESIGNATED BY AN ASTERISK (*) ONLY ATTENDED A MEETING AND DID NOT ACTIVELY PARTICIPATE. VIOLENCE OR REVOLUTIONARY ACTIVITIES WERE NOT DISCUSSED.

Information recorded on a card index by _____ on date _____

Remarks:

100-14427 (MIC)
170-286A-39
100-14483 (Tom Hyde)
100- (Phil Plymate)
100-14376 (St. Journal)
100-15112 (Swirise)
100-14373 (Phelps)

Block Stamp

170-286A-39

SEARCHED <input checked="" type="checkbox"/>	INDEXED <input checked="" type="checkbox"/>
SERIALIZED <input checked="" type="checkbox"/>	FILED <input checked="" type="checkbox"/>
SEP 25 1970	

Christensen

REPORT BY JEROME
September 18, 1970

This morning I went to Message Information Center, arriving there at about 10:30 AM. Already there were TOM HYDE and a young high school kid named STEVE (LNU) who was learning how to be a MIC operator.

I shot the breeze with HYDE for about an hour. He told me he is now Acting Co-ordinator for MIC. He said there will be a change in MIC leadership as he, HYDE, will be leaving in about a month. He did not say where he is going.

The former MIC co-ordinator, PHIL PLYMATE, is supposed to be going to work full time with the San Diego Street Journal. According to HYDE, both the Street Journal and Sunrise are supposed to be out again in a few weeks. HYDE said there will be mostly new people on the Street Journal staff.

HYDE also talked about MIC's "Fugitive File". This file contains information on how to help deserters and draft dodgers get out of San Diego. He said the file had been taken out of MIC and hidden because many of the people connected with this work had been questioned about it recently by the law.

Jerome

He said that when things cooled down, the file will be improved and put back into MIC. He said one of the things they planned to do is to ask anyone who calls for help if he is a Federal Agent, thus hoping to trap him. He also said that apparently some of the servicemen who were helped in the past spilled the whole story about MIC and other people when they got back to their Base.

I stayed at MIC until about one o'clock. After awhile HYDE left, and I spent the rest of the time showing STEVE how to do the work. I received and gave out a lot of weird messages. I was able to obtain the following interesting information:

HYDE's telephone number is 582-8203. PLYMATE's telephone number is 232-8657. New Adult Communities new telephone number is 239-2119, and RICK PHELPS' new address and emergency only telephone number are 2810 31st Street, telephone number 283-1934.

I agreed to pull another shift at MIC this Thursday from 1:00 to 5:00 PM.

Jerome

Date prepared

9/30/70

Date received
9/21/70

Received from (name or symbol number)
INFORMANT
[SD 1155-R]

Received by
SA Steven L. Christensen

Method of delivery (check appropriate blocks)

in person by telephone by mail orally recording device written by Informant

If orally furnished and reduced to writing by Agent:
Date

Date of Report

9/21/70

Dictated _____ to _____

Date(s) of activity

9/20/70

Transcribed _____

Authenticated by Informant _____

Brief description of activity or material

Info re MAM activities +
Bill Clay

File where original is located if not attached

170-286A

* INDIVIDUALS DESIGNATED BY AN ASTERISK (*) ONLY ATTENDED A MEETING AND DID NOT ACTIVELY PARTICIPATE. VIOLENCE OR REVOLUTIONARY ACTIVITIES WERE NOT DISCUSSED.

Information recorded on a card index by _____ on date _____

Remarks:

~~152-1798~~
~~100-12461~~ (MAM)
170-286A-40
100-14293 (Clay)
100-13474 (SDS)

Index: Wyndham Arthur
Henshaw; Dr.
100-12375 Fred Schwartz

Block Stamp

170-286A-40
SEARCHED [] INDEXED []
SERIALIZED [] FILED []
OCT - 6 1970
FBI - SAN DIEGO

REPORT BY JEROME
On September 21, 1970

BARRY GODFREY told me that he contacted BILL CLAY yesterday who gave him three boxes of papers belonging to the SDS Group at the University of California at San Diego. CLAY apparently got them from one of the janitors out there.

CLAY has almost completed his pilots training and will get a pilot's license next month. After that he intends to use his license to fly various places to carry on right wing activities.

A possible new Minute-man member is WYNHAM or WYNDMAN ARTHUR HENSHAW who lives at 1902 Guy Street, in the Mission Hills area of San Diego, with telephone number 298-4480. He and several other people including a woman named LYLIA BUCK, a group from Scott Memorial Baptist Church and a group from the Christin Anti-Communist Crusade the leader of which is Dr. FRED SCHWARTZ, are planning to go to the Victory march in Washington, D.C., on October 3, 1970. The group from the Baptist Church is chartering an airplane to fly there.

When I talked to BILL CLAY yesterday I told him what I was doing at Message Information Center and he suggested putting some kind of listening device on the telephone there. He said he would start experimenting around at work today to see what he could come up with.

He told me he has gotten ahold of some new three strand wire which is transparent to the eye and can only be seen under certain lighting conditions. He said this wire is being used in some experiments at the University of California at San Diego.

Jerome

Date prepared

9/30/70

Date received

9/24/70

Received from (name or symbol number)

Informant
SD 1155-R

Received by

SA Steven L. Christensen

Method of delivery (check appropriate blocks)

in person by telephone by mail orally recording device written by Informant

If orally furnished and reduced to writing by Agent:

Date

Date of Report

9/24/70

Dictated _____ to _____

Date(s) of activity

Transcribed _____

Authenticated by Informant 10/9/70

Brief description of activity or material

MM activities

9/23/70

File where original is located if not attached

170-286A

* INDIVIDUALS DESIGNATED BY AN ASTERISK (*) ONLY ATTENDED A MEETING AND DID NOT ACTIVELY PARTICIPATE. VIOLENCE OR REVOLUTIONARY ACTIVITIES WERE NOT DISCUSSED.

Information recorded on a card index by _____ on date _____

Remarks:

157-1798
~~100-12461~~ (MM)

170-286A-41

100-14356 (Peter Ruppinger)

100-14869 (Barry Godfrey)

100-14293 (Clay)

100-15356 (George Hoover)

~~100-157-1870~~ (Frank Yacoppe)

100-15381 (STR Rally)

100-14911 (People's Commune)

Index : Mike McGan
Gerald Moran
Charles Throp

Block Stamp

170-286A-41

SEARCHED [] INDEXED []
SERIALIZED [] FILED []
OCT - 5 1970
FBI - SAN DIEGO
[Signature]

REPORT BY JEROME
September 24, 1970

Yesterday PETER RUPLINGER told me that the Minutemen now have obtained the following Post Office Boxes:

- 1) Post Office Box 3064
La Mesa, California
In the name of HOWARD GODFREY or MIKE MC GAN
- 2) Post Office Box 76
Spring Valley, California
In the name of GERALD MORAN
- 3) Post Office Box 2351
La Mesa, California
In the name of CHARLES THROP

Some right wing people are excited about the STP rally on October 3, 1970, and may attempt to create a little excitement. One of the suggestions made was to place black powder or primacord in the cracks along the railroad tracks over which the marchers will pass and ignite it as they go by.

I learned that approximately one month ago FRANK YACOPEC shot a large size steal nut through a window of the Commune at 2nd and Thorn striking a hippie inside squarely on the side of the head. The hippie dropped as if shot but nothing has been heard about it since.

GEORGE HOOVER has been very quiet lately and no one, including BILL CLAY seems to know where he is or what he is doing.

I learned this afternoon that STP is going to hold a meeting at the 2nd and Thorn Commune at 3:00 P.M., today which I will attend if I can.

Jerome

SAC, SAN DIEGO (100-14376)

9/22/70

SA ARNOLD W. O'BRIEN

SAN DIEGO STREET JOURNAL
SM - ANA

informant
~~SD 1155-R~~ telephonically advised SA O'BRIEN as follows: on 9/16/70:

Information has come to sources attention that the San Diego Street Journal intends to re-instate the paper and will attempt to get out an issue of the Street Journal within the next two weeks.

According to source, the Street Journal intends on devoting a great deal of its journalistic efforts towards women's liberation.

Source stated that information has come to his attention that the Street Journal has an unlisted telephone number 235-4478. According to source, individuals desiring to contact the Street Journal telephonically contact the Message Information Center (MIC) at 531 19th Street, San Diego, California. The MIC will not give out the unlisted telephone number of the Street Journal, but will forward any information desired.

- 1 - 100-14376
- ① - 170-286 X
- 1 - 100-14720 (Women's Liberation)
- 1 - 100-14427 (MIC)

AWO:vlh
(4)

informant
~~SD 1155-R~~ advised that he received the information contained in this memo from JIM STEWART, who is connected with MIC.

Source further advised that he believes he has the opportunity of getting into the MIC organization and can be placed on a tour of duty with MIC in the near future. *100-14376-40*

vlh

SEARCHED	INDEXED
SERIALIZED	FILED
OCT - 7 1970	
FBI - SAN DIEGO	

[Signature]

Date prepared

10/10/70

Date received

9/25/70

Received from (name or symbol number)

SD 1155-R

Received by

SA Steven L. Christensen

Method of delivery (check appropriate blocks)

in person by telephone by mail orally recording device written by Informant

If orally furnished and reduced to writing by Agent:

Date

Dictated

10/10/70 to Linda Elegido

Transcribed

10/10/70

Authenticated by Informant

10/9/70

Date of Report

9/25/70

Date(s) of activity

9/24/70

Brief description of activity or material

Info re MIC, STP Rally
Exploring Family School

File where original is located if not attached

170-286A

* INDIVIDUALS DESIGNATED BY AN ASTERISK (*) ONLY ATTENDED A MEETING AND DID NOT ACTIVELY PARTICIPATE. VIOLENCE OR REVOLUTIONARY ACTIVITIES WERE NOT DISCUSSED.

Information recorded on a card index by _____ on date _____

Remarks:

100-14427 (MIC)
170-286A-43
100-15381 (STP)
100-14376 (St. Journal)
100-14737 (Family School)

Block Stamp

170-286A-43

SEARCHED	INDEXED <input checked="" type="checkbox"/>
SERIALIZED <input checked="" type="checkbox"/>	FILED <input checked="" type="checkbox"/>
OCT - 6 1970	
FBI - SAN DIEGO	

[Handwritten signature]

SEPTEMBER 25, 1970

Yesterday, I spent four hours at Message Information Center, working the switchboard from 1:00 PM to 5:00 PM. I spent most of my time there copying about 300 names and addresses from the MIC files which I will furnish in the near future.

Last night, there was an STP organizing meeting at the Street Journal building at Second and Thorn. Apparently, that was the only STP meeting which will be held before the STP demonstration on 10/3/70.

Exploring Family school has apparently moved to El Cajon and has a new telephone number which I will also furnish soon.

JEROME

Jerome

Date prepared

10/6/70

Date received

10/2/70

Received from (name of symbol number)

~~SA [unclear]~~
SD 1155-R

Received by

SA Steven L. Christensen

Method of delivery (check appropriate blocks)

in person by telephone by mail orally recording device written by Informant

If orally furnished and reduced to writing by Agent:

Date

Dictated

10/10/70 to Linda Elegido

Transcribed

10/6/70

Authenticated by Informant

10/9/70

Date of Report

10/2/70

Date(s) of activity

10/1/70

Brief description of activity or material

Info re MIC

File where original is located if not attached

* INDIVIDUALS DESIGNATED BY AN ASTERISK (*) ONLY ATTENDED A MEETING AND DID NOT ACTIVELY PARTICIPATE. VIOLENCE OR REVOLUTIONARY ACTIVITIES WERE NOT DISCUSSED.

Information recorded on a card index by _____ on date _____

Remarks:

100-14427 (MIC) Index: Orange County True
170-286A-44 Pres to ~~100-12464~~
100-13847 (SMC) 157-1798
100- (Mike Milligan) (dead if no file)
~~100-157-781~~ (Burt Halsetma)
100-14737 (Family School)
~~100-12464~~ (MMF)
157-1798

Block Stamp

170-286A-44

SEARCHED	INDEXED
SERIALIZED	FILED
OCT - 8 1970	
FBI - SAN DIEGO	

Christensen

OCTOBER 2, 1970

Attached are some lists of names, addresses and telephone numbers which I got at MIC. The one page list with telephone numbers only is the Student Mobilization Committee (SMC) contact list which includes some high school students. The second page list with both addresses and telephone numbers is a list of MIC operators and contacts.

I also learned that MIKE MILLIGAN lives at 7080 Saranac, San Diego, but has telephone numbers 460-2515, 460-6100 and 469-3080.

Exploring Family school has telephone number 442-5287.

BURT HALSEMA has P. O. Box 15602, Andrew Jackson Station, San Diego, California, and telephone number 442-9092.

Attached is the latest copy of the Orange County True Press which was received in one of the Minutemen mail boxes.

JEROME

Jerome

McKenna 2395765 San Diego High
 Brown 582-5433
 Dick Rosenthal 583-9003 Crawford
 Jan Kato 582-1184 Crawford
 Tommy Pomeroy 295-9231 Mesa
 Juley Gaulten 221-2795 Kappa Hall Cal. Western
 Tom Meyers 273-5795 Mesa?
 Bud Saska 582-6504
 Judge Gonzalez 261-1138
 Bob Peterson 268-2293
 Earl Flomald 262-5919 Special note
 Herb Hunter 262-6350 " "
 Petra Glean 458-4790 " "
 Unitarian Church 296-9778
 Rhetta Alexander 233-9506
 Issy Flann 402-1067
 Tony Forasa 235-7231
 Caryl Allen BSU 263-1251
 Charles Roberts 231-5629
 Dale Brown 278-1640
 Carl Chenshir 582-0355
 Byron King SSS 234-1535
 John Fortinore " "
 Art H LAMM 451-2436
 Keith Harrison 583-1626
 Tony Kolgos USSB 431-0641
 Sara Kristen no phone P.O. Box 3411 S.D. 92103
 Kent & Pat Nikison 2133 N. Santa Fe Vista, Co. 92083 724-1563
 James Taylor
 Tom Hyde 531 19th St. S.D. N.I.C. 232-6621
 Charles Richmond S.N.C. Grosmont 444-4813
 Gary DiCarlo ? Grosmont back above might be from International U.
 Jack Cahine ? " " "
 Ed Davis 7404 Alvarado Rd. #114 no phone
 Marty Wilson 583-4566 Patrick Henry *
 Anne Donovan (Donnie's sister) no phone
 Tony Anderson 277-1176 Indison
 Robbie Tucker 222-9734 * Point Loma
 Brian Whitefield 274-0427 Indison
 Earl Morse 223-8354 Point Loma
 Elio Gindloff 465-6919 P.H.
 Barbara Segal 582-1378 P.H.
 Kelly Franklin 582-8247 P.H.
 Kyle Capralls 465-4561 P.H.
 Eric K. Kovacs Mesa ? ask Alan 583-5476

- 1) We need more U.S. contacts, someone should concentrate on this.
- 2) All the colleges in our area need more work, with the exception of Grosmont
- 3) We should discuss how to talk to people, how to follow up leads, etc.
- 4) We should keep a centralized list of all our anti-war contacts

STAC U N I T I I 465 3069

Jerome

Susan McKenna 582-2100

Street
go, California 92100

Ira Adelman	3611 31st St., 92104	283-8358
Benson		
and Bleu	6208 Tarragona Dr. 92115	286-9971
eg Brown	5139 Clairemont Mesa Blvd., 92117	-
die Brown	2545 "J" St., 92102	232-3538
laine Budzinski	3009 1/2 Beech, 92102	583-3088
Frank & Donna Buhrman	173 Cedaridge Dr., 92114	479-7151
Angel Chesebro	2627 "C" St. 92102	MIC
Mary Clark	2627 "C" St., 92102	MIC
Colby Crotzer	2529 Island Ave. 92102	MIC
Danny Davis	7719 Orien St., La Mesa 92041	-
David Doan	4374 Lograno Dr. 92115	286-4888
Sharon Dunn	1232 W. Redwood, Apt. D,	-
Tom Dunn,	4520 Olney St., 92109	-
Gini Fenley	2545 "J" St., 92102	232-3538
Ozzie Gontang	3323 Boundary St., 92104	-
Linda Greenwell	173 Cedaridge, 92114	479-7151
Sandy Horner	410 26th St., 92102	233-4529
Bill Hulsey	835 Halecrest Dr., Chula Vista	420-0843
Tom Hyde	2529 Island, 92102	235-9231
Eilëen Jackson	2565 "J" St., 92102	233-5501
Bill King	2069 Abbott, #3, 92107	--
Don Knight	6262 1/2 Stanley Ave., 92115	286-8784
Jan Labao	1639 Guy St., 92103	295-4201
Darr MacDonaid	1300 Dale St., 92102	232-8200
Susan, Gerre, Dick McKenna	1535 29th Street, 92102	239-5766
Viola McKern	3023 Washington, Lemon Grove 92045	469-3777
Beth Marley	4263 Lamont St, 92109	-
Larry Meyer	3705 Mission Blvd., 92109	488-3475
Jane Mills	615 Circle Dr., Solana Beach 92075	755-1251
Egor & Sandy Parker	3830 44 St., #8, S.D.	283-9644
Jack Rice	1008 Edgemont Pl., S.D.	-
Doyce Ross	1408 Ebbs St., 92114	-
Robin Russell	173 Cedaridge, 92114	479-7151
Bob Sanders	4260 Narragansett, 92107	223-3675
Paul Schoulmann		463-3735
Mari Ruth Seamna	807 Redondo Ct., 92109	488-8706
Sheryl Semans	2545 "J" St., 92102	232-3538
Ann Spangler	5162 Pirotte, 92105	262-0661
June Stanley	803 Redondo Ct., 92109	-
Betty Strickler	814 Diamond, S.D.	-
Chris Strydesky	1352 Dale, 92102	-
Sean Sweeney	106 "B" St., Imperial Beach,	-
Robbie Tucker	3644 Liggett Dr., S.D.	222-9734
Lisa Urso	2545 "J", 92102	232-3538
Wayne Wilson	556 61st St., 92102	-
Mike DeVore	2588 "J" St., 92102	2340-9052
Sherri McDonald	4674 Isleta Ave., 92117	273-6850
Ron & Shirley Snowden	417 27th St., 92102	233-7936
Betsy Beloff		

Jerome

gn

11/19/69

ORANGE COUNTY

reet
California 92102

ADDITIONS - MIC OPERATOR LIST
(for home use)

arton	8745 Hartzel Dr. Spring Valley	460-5246
Cherton	8745 Hartzel Dr. Spring Valley	460-5246
echt	4916 Uvada Pl.	281-7163
own	2412 J. St. S.D. 92102	235-9265
Cascio	4266 Lamont St. S.D. 92109	274-8939
le Davidson	3004 Greyling Cr. S.D.	277-2962
y Dempster	743 Ensenada Court S.D. 92109	488-3560
ic Doan	4374 Logrono Dr. S.D. 92115	286-4888
ve A. Dugan	2529 Island, S.D.	235-9231
om Lunn	4266 Lamont St. S.D.	274-8939
at Fero	2176 Julian St. S.D. 92113	234-7518
Margo Gallagher	3201 Mobley St., S.D.	277-3683
Sheri Macdonald	4674 Isleta Ave. S.D. 92117	273-6850
Jim McDonald	4874 Isleta Ave. S.D. 92117	273-6850
John A. Richardson	2529 Island Ave. S.D.	235-9231
Bill Sanger	4266 Lamont	274-8939
Herman Shoemaker Jr.	1542 Gowin St. Spring Valley, 92077	469-4748
dawn Leilani Smith	2881 Murray Ridge Rd	278-8709
Steven C. Spencer	2122 Ocean View S.D.	232-2680
Carol Tozer	5019 Williams Ave. La Mesa, 92041	460-7686
Karen Walker	1652 Casita Way	523-2615

Jerome

Date prepared

10/6/70

Date received

10/5/70

Received from (name of symbol number)

Informant
SQ1155-R

Received by

SA Steven L. Christensen

Method of delivery (check appropriate blocks)

in person by telephone by mail orally recording device written by Informant

If orally furnished and reduced to writing by Agent:

Date

Dictated

10/6/70 to Linda Elegido

Transcribed

10/6/70

Authenticated by Informant

10/6/70

Brief description of activity or material

Info re STP Rally 10/3/70

Date of Report

10/5/70

Date(s) of activity

10/3/70

File where original is located if not attached

170-286A

* INDIVIDUALS DESIGNATED BY AN ASTERISK (*) ONLY ATTENDED A MEETING AND DID NOT ACTIVELY PARTICIPATE. VIOLENCE OR REVOLUTIONARY ACTIVITIES WERE NOT DISCUSSED.

Information recorded on a card index by _____ on date _____

Remarks:

100-15381 (STP)

170-286A-45

100-14377 (Progressive Labor Party)

105-7212 (Nibbe)

105-7221 (Calderon)

157-~~157~~-new (Soledad Brothers Trial)
RM

157-14820 (Frank Yacopac)

100-14277 (Women's Liberation)

100-14622 (Experimental College)

~~Index~~: Committee to Free the Soledad Brothers

157 new
157-2188

Block Stamp

170-286A-45
SEARCHED 7 INDEXED
SERIALIZED 7 FILED
OCT 10 1970
FBI - SAN DIEGO

OCTOBER 5, 1970

I discretely observed the STP demonstration last Saturday. The march and rally looked like a failure to me because they only had 200 people participating when they had announced that they expected 4,000 or 5,000 to join in.

I was really surprised at the hostility of the bystanders and onlookers toward the marchers. Many of them were yelling "Communist", "Pigs", and "Go to Russia" at the marchers. The sailors and Marines along Broadway were very menacing and several times I thought there were going to be fist fights.

The demonstrators did not stop at the 11th Naval District Headquarters building or at the Police Department headquarters but just walked by chanting and shouting obscenities.

There were three speakers for the rally at Newtown Park. The first was RON NIBBE, who apparently had just been arrested by the police and talked about his arrest and how it was unjustified. He said everyone should be good Communist comrades and buy guns. He said that the people should oppose and defeat the police and completely eliminate them. He said it was unwise to seek community control of the police and by having them live in the communities because then they would know what was going on all the time.

The next speaker was a young male Negro individual who said he was a representative of the Committee to Free the Soledad Brothers. He said the Soledad brothers trial is going to be moved to San Diego and that as much of the committee as possible would also be moved to San Diego. He said however, that many people who belonged to and worked with the committee up north won't be able to come to San Diego and that the committee needs volunteers from the San Diego area to carry on its work. I didn't know what this person's name was.

The last speaker was CARLOS CALDERON who said he wanted to organize the Chicano movement and truth about the great heritage of the Latinos and gave several examples such as CHE GUEVARRA with whom he apparently was very impressed.

Jerome

It was announced that Experimental College at San Diego State College is going to have a workshop course on Communism this fall.

At the rally, there was a guy going around selling a copy of "Challenge" saying that it was a Communist newspaper. I believe I heard someone call him by the name of MIKE. He was about 6'1" tall, 220 pounds, brown hair, receding at the forehead, 28 years old. He was accompanied by a girl name KATHY, who is apparently connected with Women's Liberation and PLP. KATHY was about 5'5", in her early 20's, curly brown hair, very slim build. These people said that there is a new discussion meeting each Sunday on "Challenge" and PLP and wrote down the address and phone number down for me, 3993 Broadway, San Diego, telephone 263-1465.

FRANK YACOPEC was also at the rally wearing an old felt hat full of holes, a phoney FU MANCHU mustache and a fatigue jacket. No one paid any attention to him.

Leaving the rally, I almost got into a fight with three people who were very uptight and thought I must have been a Lefty.

Jerome

Date prepared

10/19/70

Date received

10/7/70

Received from (name or symbol number)

SD/1155-R

Received by

SA Steven L. Christensen

Method of delivery (check appropriate blocks)

in person by telephone by mail orally recording device written by Informant

If orally furnished and reduced to writing by Agent:

Date

Date of Report

10/7/70

Dictated

10/12/70 to Glen Fuller

Date(s) of activity

Transcribed

10/15/70

Authenticated by Informant

Brief description of activity or material

Info re Jim Stewart; M.A. Oge,
Anti-War Rally 10/31/70

File where original is located if not attached

170-286A

* INDIVIDUALS DESIGNATED BY AN ASTERISK (*) ONLY ATTENDED A MEETING AND DID NOT ACTIVELY PARTICIPATE. VIOLENCE OR REVOLUTIONARY ACTIVITIES WERE NOT DISCUSSED.

Information recorded on a card index by _____ on date _____

Remarks:

100-15475 (Jim Stewart) Index: Glen Moore to
170-286A-46
100-13697 (Shapiro)
100-14922 (CMC)
~~157-1795~~
~~100-12461~~ (MM)
157-1518 (Margaret L. McNichols)
100-14319 (Barry Godfrey)
100-15414 (10/31/70 Rally)

Block Stamp

170-286A-46

SEARCHED	INDEXED
SERIALIZED	FILED
OCT 20 1970	
FBI - SAN DIEGO	

10/7/70
by Jerome

JIM STEWART, the fellow who has in his possession SYLVIA SHAPIRO's CMC mailing list, is about 19 years old, clean cut, short hair, seems to be very intelligent and I believe he is a student. He lives near the beach and it looks like he is a person who is mainly responsible for organizing the anti-war demonstration in San Diego on 10/31/70.

I heard some very interesting information about a store at Julian named the Mountain Market Grocery. Apparently the people at the store are openly advising for the Minutemen organization and are selling minutemen and other right-wing literature over the counter at the store. I was also told that collections for DE PUGH's legal defense are also being taken at the store. I will probably get up there soon and see what's going on.

I learned from BARRY GODFREY that GLENN MOORE picked up a hippie female hitchhiker earlier in the week. She was apparently very radical, but MOORE got friendly with her and she told him that the recent fires in the mountains were mostly set by leftists and were part of a leftist plot.

I also learned that there is going to be a showing of a film and a fund raising event at the Kent Theater on 10/15/70 to raise money and to make plans for the anti-war demonstration on 10/31/70.

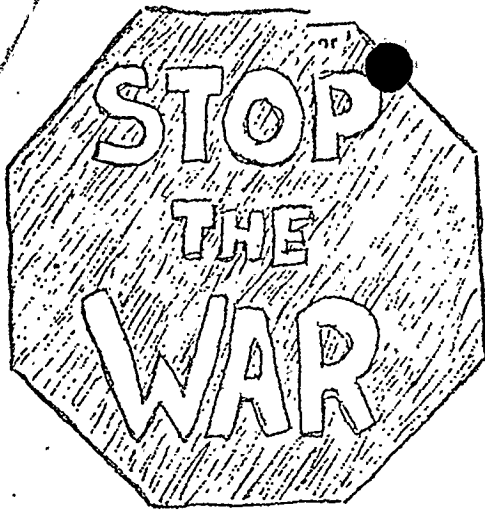

City Wide ANTI-WAR Meeting

The National STUDENT MOBILIZATION COMMITTEE has called for nation-wide mass demonstrations for OCTOBER 31st. The SMC here in San Diego, in line with this national day of protest to the war in Vietnam, is calling for a city-wide organizational meeting to make OCTOBER 31st in San Diego the biggest ever !!!!! If you are opposed to the war COME AND HELP !!!!!!!

OCTOBER 10 — SATURDAY — 11:00 — MONTEZUMA HALL, AZTEC CENTER SDSC

ON TO OCT. 31ST !!

Information recorded on a card index by _____ on date _____

Remarks:

100-15475 (Jim Stewart)

Index: Glen Moore to

170-286A-46

100-13697 (Shapiro)

100-14922 (CMC)

~~151-1295~~
~~100-1246~~ (MM)

157-1518 (Margaret L. McNichols)

100-14319 (Barry Godfrey)

100-15414 (10/31/70 Rally)

Block Stamp

170-286A-46

SEARCHED	INDEXED
SERIALIZED	FILED
OCT 10 1970	
FBI - SAN DIEGO	

[Signature]

Date prepared

10/19/70

Date received

10/8/70

Received from (name or symbol number)

50 MISS-R

Received by

SA Steven L. Christensen

Method of delivery (check appropriate blocks)

in person by telephone by mail orally recording device written by Informant

If orally furnished and reduced to writing by Agent:

Date

Dictated 10/12/70 to Glen Fuller

Transcribed 10/15/70

Authenticated by Informant

Date of Report

10/8/70

Date(s) of activity

10/8/70

Brief description of activity or material

Info re MIC + Phil Plymate

File where original is located if not attached

170-286A

* INDIVIDUALS DESIGNATED BY AN ASTERISK (*) ONLY ATTENDED A MEETING AND DID NOT ACTIVELY PARTICIPATE. VIOLENCE OR REVOLUTIONARY ACTIVITIES WERE NOT DISCUSSED.

Information recorded on a card index by _____ on date _____

Remarks:

100-14427 (MIC)

170-286A-47

100-15399 (Phil Plymate aka Plymate)

Block Stamp

170-286A-47

SEARCHED	INDEXED
SERIALIZED	FILED
OCT 23 1970	
FBI - SAN DIEGO	

[Signature]

10/8/70
Jerome

While I was at MIC today I learned about an individual who is believed to be an undercover police officer by the leftists. This individual is 40 to 50 years old, has dark greying hair, is unshaven and goes by the name BODINE or BOLIVAR or some such similar name. Apparently he showed up several weeks ago looking for a ride to the east coast. He claimed to have been connected with a free school somewhere in California and also at Santa Barbara. He always carries a sleeping bag with him and "crashes" wherever he can. The people here have been checking on him and contacted the free schools at Santa Barbara and in Colorado and found out that he wasn't known there. This plus the fact that he is still around after having looked for a ride to the east coast makes him believe he is with the police.

I also saw and met PHIL PLYMALE. He is extremely weird looking and has a very strange beard and hair-do even for the people at Message Information Center. He impresses me as being very paranoid and is highly suspicious of everyone.

Date prepared

10/19/70

Date received

10/12/70

Received from (name or symbol number)

SA 1155-R

Received by

SA Steven L. Christensen

Method of delivery (check appropriate blocks)

in person by telephone by mail orally recording device written by Informant

If orally furnished and reduced to writing by Agent:

Date

Dictated

10/12/70 to Glen Fuller

Transcribed

10/15/70

Authenticated by Informant

Date of Report

10/12/70

Date(s) of activity

10/9-11/70

Brief description of activity or material

Info re Marg McNichols, MM Org.,
AVG, Robert DeBugh, Sunrise
Bill Clay

File where original is located if not attached

170-286A

* INDIVIDUALS DESIGNATED BY AN ASTERISK (*) ONLY ATTENDED A MEETING AND DID NOT ACTIVELY PARTICIPATE. VIOLENCE OR REVOLUTIONARY ACTIVITIES WERE NOT DISCUSSED.

Information recorded on a card index by _____ on date _____

Remarks:

157-1515 (Margaret L. McNichols)
170-286A-48
100-12461 (MM)
100-13832 (Patriotic Party)
100-100-14541 (AVG)
100- (Julian Commune - open 100 dead)
100-15712 (Sunrise)
100-157-1520 (Frank Yacofec)
100-15428 (Jim Stewart)
100-~~14376~~ 14376 (St. Journal)
100-14293 (Bill Clay)

Index: Patriotic
Action Legion to
157- John
Ozemanec to AVG.
Glen Jackson to
100-13832. Non-
violent Action Centre
to Jim Stewart.

Block Stamp

170-286A-48
SEARCHED _____ INDEXED _____
SERIALIZED 1/1 FILED 1/2
OCT 23 1970
FBI - SAN DIEGO
Christensen

10/12/70

Jerome

Last Friday, I went up to Julian to the Mountain Market Grocery Store and met the owner, whose name is MARGIE MC NICKLES. MC NICKLES sells Minutemen, Ku Klux Klan and other similar literature and material across the counter at her store.

She is also working with the Patriotic Party in San Diego and told me that she is going to try to form a chapter of the Patriotic Action Legion in San Diego.

Her son is supposed to be President of the Young Republicans Organization at Grossmont College.

She told me that ROBERT DE PUGH has been on trial for all the Federal charges against him at Albuquerque, New Mexico, and has been held in the City Jail there. She said DE PUGH was to have been sentenced on 10/9/70 and said that he was asking for a total of ten years each on nine separate counts.

MC NICKLES said that the jailors at the Albuquerque City Jail are taking very good care of DE PUGH as most of them are very sympathetic to him. MC NICKLES also made a statement to the effect that if DE PUGH is sent to Leavenworth he will never get there which I took to mean that there may be an escape attempt.

MC NICKLES also said that she knows JOHN ZEMANEC of AVG and GLENN JACKSON of the Patriotic Party at Los Angeles. She showed me an open letter which DE PUGH wrote to ZEMANEC telling him to get completely out of right-wing activities. She also had some other stuff which she claimed to have just recently received from DE PUGH.

MC NICKLES also told me there is a commune at Julian not far from her place. She said these people are long hairs, but clean and drive nice cars. She said they moved in several months ago paying \$32,000 cash money for the house. She said

that although the former owner of the house told her he sold the house to a woman she has seen only male individuals at the house. She said there are only a few individuals who stay at the house during the week, but that several carloads of male individuals arrive each Friday evening and stay over until Monday morning. She said she and her husband feel that some kind of training is going on at the commune as they have been able to hear radio Morse Code signals from the house in the evenings when the wind is right.

She said the person who is always at the house, which is located on Whispering Pines Drive, drives a Car with California License TXL 136 which also has a Yale sticker on it. She said cars with the following license plates have shown up there on the weekends:

VGL 342
OKU 316
RGD 465
WTH 134

I have learned that SUNRISE now has a bookstore at 4855 El Cajon Boulevard. FRANK YACOPEC has been talking about breaking the windows of the store.

JIM STEWART, address 5854 Ithaca Place, telephone 453-4867, has apparently been connected with a group called the Non-violent Action Center.

"The San Diego Street Journal" has a brand new telephone number which is 235-4478.

BILL CLAY went out of town Friday night and did not get back until late Sunday night. He now has his pilot's license and is certified to fly solo and wherever he went he flew.

CLAY told me that the Minutemen lost some stuff during the recent fires in the back country. He said included in the losses were a Lewis Machine Gun and several other small machine guns and some ammunition and explosives which

weren't buried deep enough. He said the losses weren't serious and that most of the stuff weren't hurt. He was talking about running a survey to locate all the buildings and warehouses and other places in the county where ammunition and explosives are stored so that these places could be cleaned out or blown up in the event it looked like the left was serious about starting the revolution.

He was also talking about unburying 500 pounds of explosives to have ready to use in the event of an emergency. He also said the Minutemen in the area have acquired a new 20mm Caliber Lahti anti-tank rifle.

UNITED STATES GOVERNMENT

Memorandum

TO : SAC, SAN DIEGO (157-1798)

DATE: 1/8/71

FROM : SA STEVEN L. CHRISTENSEN

SUBJECT: MINUTEMAN ORGANIZATION (MM)
RM - MM

On this date *Wynn* SD 1155-R advised of the following information.

In his contacts with members of the MM organization and other Right Wing activists and sympathisers, it has become apparent that some of these individuals are ~~making~~ ~~efforts~~ making efforts to establish a list of targets which would be subject to sabotage or would be taken out of commission in the event these individuals deemed that a communist or other totalitarian takeover of the federal government appeared imminent.

In this regard source advised he had recently been in contact with JERRY LYNN DAVIS and GEORGE HOOVER. They told source of having made a trip to Ramona, California, for the express purpose of observing the FBI radio station there as a possible target of sabotage as described above. Source said these individuals expressed surprise at finding no armed guards posted at the radio station. They also said they had found no other protective devices such as observation or alarm systems or fences.

Source did not know the exact date DAVIS and HOOVER were at Ramona, and apparently neither he nor the other two are aware of the existence of two FBI radio installations at Ramona. This fact was not disclosed to source.

- 1 - SD 157-1798 (RM)
- 1 - SD 100-14297 (JERRY LYNN DAVIS)
- 1 - SD 100-15356 (GEORGE HOOVER)
- ① - SD 170-236A

SLS/slc
(4)

170-236A-49

SEARCHED	INDEXED
SERIALIZED	FILED
JAN 8 1971	
FBI - SAN DIEGO	

Date prepared
1/27/71

Date received
10/12/70

Received from (name or symbol number)
Informant
~~SD 1155-R~~

Received by
SA Steven L. Christensen

Method of delivery (check appropriate blocks)
 in person by telephone by mail orally recording device written by Informant

If orally furnished and reduced to writing by Agent:
Date _____
Dictated _____ to _____
Transcribed _____
Authenticated by Informant _____

Date of Report
10/12/70

Date(s) of activity
Week ending
10/12/70

Brief description of activity or material
*Info re. Sam Davis, Barry Godfrey,
Geo. Hoover + MM activities*

File where original is located if not attached
170-286A

* INDIVIDUALS DESIGNATED BY AN ASTERISK (*) ONLY ATTENDED A MEETING AND DID NOT ACTIVELY PARTICIPATE. VIOLENCE OR REVOLUTIONARY ACTIVITIES WERE NOT DISCUSSED.

Information recorded on a card index by _____ on date _____

Remarks:

- 100-14819 (Barry Godfrey)
- ~~170-286A-50~~
- 100-14297 (Sam Davis)
- 100-15356 (George Hoover)
- 100-9857 (Harry Raja)
- 157-1798 (MM)
- 100-15112 (Sunrise)

170-286A-50
Block Stamp

SEARCHED 43 INDEXED
SERIALIZED 1 FILED B
JAN 27 1971
FBI - SAN DIEGO
[Signature]

On 10/12/70
By Jerome

It has been learned that BERRY GODFREY was in contact with SAM DAVIS last Saturday. Apparently he and GEORGE HOOVER and several other people are planning to change their names, occupations and so on and try to disappear. They are supposed to be going "north", however the exact location is not known. Their purpose in doing this is to start a Minutemen Commune as a base of operations against the Left. They have photographs which they claim were taken of people at Communes in the Northern California area wearing fatigues and practicing with rifles. They will try to locate these communes and conduct terrorist activities against them.

It was also learned that DAVIS attended a recent gun show at El Paso, Texas. He reportedly said he would put GODFREY in touch with his suppliers, who can get anything in the way of weapons, ammunition and explosives and other articles when he leaves.

Apparently DAVIS and HOOVER will put this plan into effect during the first part of 1971.

It is known that HARRY RUJA, Professor at San Diego State College, has been more active lately. He has been involved in trying to organize some sit-ins and some protests against the arrest of LEON NOWER. He looks as though he may be trying to take NOWER's place as the radical faculty leader at San Diego State College.

It was also learned that a Datsun pickup truck which RUJA drives to work was burned up on his driveway last Saturday night. It is suspected that some of the local Minutemen may have been responsible.

It was also learned that over the last weekend the windows at the Sunrise Book Store were broken.

Jerome

BETTIE HOUGHTON has not been seen for several months. She is not reported to be doing anything and it looks as though everyone is more or less staying away from her. It is believed however she is still being contacted by DENNIS MOWER from Los Angeles.

Jerome

Date prepared

1/27/71

Date received

10/15/70

Received from (name or symbol number)

Informant
SD 1155-R

Received by

SA Steven L. Christensen

Method of delivery (check appropriate blocks)

in person

by telephone

by mail

orally

recording device

written by Informant

If orally furnished and reduced to writing by Agent:

Date

Date of Report

10/15/70

Dictated _____ to _____

Date(s) of activity

10/14/70

Transcribed _____

Authenticated
by Informant _____

Brief description of activity or material

Weapons in possession of
Jerry Geyer

File where original is located if not attached

170-286A

* INDIVIDUALS DESIGNATED BY AN ASTERISK (*) ONLY ATTENDED A MEETING AND DID NOT ACTIVELY PARTICIPATE. VIOLENCE OR REVOLUTIONARY ACTIVITIES WERE NOT DISCUSSED.

Information recorded on a card index by _____ on date _____

Remarks:

100-15400 (Jerry Geyer)

170-286A-51

170-286A-51
Block Stamp

SEARCHED _____	INDEXED _____
SERIALIZED _____	FILED _____
JAN 27 1971	
FBI - SAN DIEGO	

[Handwritten signature]

On 10/15/70
By Jerome

It has been learned that JERRY GEYER had the following weapons at his house last night:

Two fully automatic .30 caliber M-2 carbines;

Three .45 caliber grease guns;

One Thompson Sub-Machine Gun;

One Swedish K (9mm grease gun style weapon);

A Colt Commando Carbine (A new experimental automatic weapon in .223 caliber which Colt hopes will replace the M-16.)

These weapons were all supposedly in good condition and were fully operational. They apparently belonged to a friend of GEYERS. It may be that the weapons are going to a gun show to be held at Yuma, Arizona next weekend. However GEYER is offering any and all the weapons for sale now.

Jerome

Date prepared

1/27/71

Date received

11/3/70

Received from (name or symbol number)

W. J. ...
SP 1155-R

Received by

SA Steven L. Christensen

Method of delivery (check appropriate blocks)

in person by telephone by mail orally recording device written by Informant

If orally furnished and reduced to writing by Agent: Date

Date of Report

11/3/70

Dictated _____ to _____

Date(s) of activity

Week ending
11/3/70

Transcribed _____

Authenticated by Informant _____

Brief description of activity or material

Activities of Geo. Hoover, Sam Davis, etc.

File where original is located if not attached

170-286A

* INDIVIDUALS DESIGNATED BY AN ASTERISK (*) ONLY ATTENDED A MEETING AND DID NOT ACTIVELY PARTICIPATE. VIOLENCE OR REVOLUTIONARY ACTIVITIES WERE NOT DISCUSSED.

Information recorded on a card index by _____ on date _____

Remarks:

- 157-1798 (MM)
- 170-286A-52
- 100-14297 (Davis)
- 100-15356 (George Hoover)
- 100-14819 (Godfrey)
- 100-157-2224 (Isaac Cantrell)
- 100-14356 (Peter Ruppinger)
- 100-13847 (SNC)
- 100-152820 (Frank Yacopee)

Info relating to SA Arnold W. O'Brien was properly handled at time of receipt.

Index Mississippi license
O F/6192030 to 100-14297.

Block Stamp

170-286A-52

SEARCHED	INDEXED
SERIALIZED	FILED
JAN 27 1971	
FBI - SAN DIEGO	

[Signature]

11/3/70
By Jerome

Attached is an SMC leaflet which I recently picked up at SDSC.

It appears that GEORGE HOOVER and SAM DAVIS are bosom buddies. They invited me to go to the Gunsmoke Ranch in Harbison Canyon last Sunday. They were both there and I also met ROGER WILLIS. In addition there were three women and two other males at the ranch whose names I did not learn.

DAVIS was in Mississippi recently and at the ranch he was driving a green Chevrolet van with Mississippi license F/6192030. He apparently broke down somewhere in Texas one the way back and HOOVER went to rescue him.

On the ranch there is a pistol range and a range with ~~photographs~~ up and running targets but that part was burned down in a recent fire. The range is being rebuilt. There are also two muzzle loading cannons on the ranch and there is a bunker or open mine shaft type of thing in the side of a hill. I could see shoring and supports inside but was not allowed to get close enough to see what it was.

HOOVER and DAVIS were practicing quick-draw shooting and hip shooting and are supposedly good shots with a .45 caliber automatic pistol. They are always armed at least with .22 caliber derringer pistol.

SAM DAVIS has many M-2 carbine parts which he will sell at a good price. He gets alot of his stuff from a place in Los Angeles, and he has approached BERRY GODFREY asking him to stop at that place the next time he is in Los Angeles and obtain some hand grenade casings. The casings are apparently being sold for \$1.00 a pice.

I learned that the house HOOVER lived in on the ranch was burned in the fire. I also learned that there are two fellows named STAN (LNU) and DAVE (LNU) who live on the ranch.

While I was there SAM was thinking about staging a punitive raid on the SDPD in retaliation for the arrest of ISSAC CANTRELL. He said however he did not know CANTRELL.

Jerome

DAVIS said he feels that the FBI and SDPD are communist controlled and he wants to neutralize them. In particular DAVIS has a special hate for Agent O'BRIEN of the FBI. He said he knows that most of the Agents are decent people who are just doing their job. However he feels that O'BRIEN is persecuting the Minutemen as a vengeance and said he would give anything to get O'BRIEN's home address and telephone number.

DAVIS said he was going to price some tear gas grenades and said he could get primacord in 500 foot lengths for \$30.00.

It was learned that the SMC anti-war march 11/1/70 was a complete failure. There were only 150 - 200 people who participated in the march, with a few more attending the rally. Nothing of interest happened and the speeches given were dull and uninteresting.

I was in contact with PETER REPLINGER yesterday. He said there has been evidence of many students in the school turning against the new left movement. He said apparently the Street Journal and its staff had been caught in some bad lies which had caused many students to be disillusioned.

It was also learned that SAM DAVIS wants to order 10000 .223 caliber bullets through BARRY GODFREY's contact which will cost \$255. It was also learned that FRANK YACOPEC wants to order 1000 M-1 carbine bullets.

Jerome

IS THE WAR GOING TO END?

NIXON SAYS WE ARE WITHDRAWING.....BUT:

FACT: Last week the Super Carrier Ranger left for Vietnam with over 5,000 men and 125 planes.

FACT: Friday morning the Carrier U.S.S. Kitty Hawk leaves San Diego also for Vietnam with another 5,000 men and 125 planes.

THIS IS ESCALATION NOT WITHDRAWAL

This war is costing you, the taxpaying citizen, \$2 million each and every day, that is approximately \$1500 a year for every man, woman and child in this country.

Because a war economy is non-productive inflation has run wild, 10% per year nationwide. Because of this war the average citizen made less real money this year than last despite pay increases. Our paychecks buy less and less each week.

This is a rich man's war. How many of the "Big Brass" get shot up? How many millionaires lose a son or father to keep this war going? FOR WHAT?

Many of the sailors on this ship realize this and do not wish to go. They will be gone today but the fight to end the war goes on. Disgust with the war is rampant within the military itself.

So long as the apathetic state of the people continues so will the war. The time to sit passively and watch has passed. Now is the time for responsible action to end the war in Vietnam.

Servicemen and civilians are working together to end this war for the first time in history. Show your support for the servicemen today.

BRING ALL THE TROOPS HOME NOW!

Date prepared

1/27/71

Date received

10/29/70

Received from (name or symbol number)

Informant
SD 1155-R

Received by

SA Steven L. Christensen

Method of delivery (check appropriate blocks)

in person by telephone by mail orally recording device written by Informant

If orally furnished and reduced to writing by Agent:

Date

Dictated _____ to _____

Transcribed _____

Authenticated by Informant _____

Date of Report

10/29/70

Date(s) of activity

10/29/70

Brief description of activity or material

Info re Bill Clay & SDS at
WCSO

File where original is located if not attached

170-286A

* INDIVIDUALS DESIGNATED BY AN ASTERISK (*) ONLY ATTENDED A MEETING AND DID NOT ACTIVELY PARTICIPATE. VIOLENCE OR REVOLUTIONARY ACTIVITIES WERE NOT DISCUSSED.

Information recorded on a card index by _____ on date _____

Remarks:

- 100-14293 (Bill Clay)
- 170-286A-53
- 100-14819 (Godfrey)
- 100-13474 (SDS)
- 100-13847 (SMC)
- 157-1798 (MM)

Block Stamp

170-286A-53

SEARCHED _____	INDEXED _____
SERIALIZED <u>B</u>	FILED <u>B</u>
JAN 27 1971	
FBI - SAN DIEGO	

[Handwritten signatures and initials]

On 10/29/70
By Jerome

I was told that BERRY GODFREY was in touch with BILL CLAY today. CLAY claims that there have been the beginnings of some right wing activities at UCSD. He said that the SDS there tried to stage a protest against the Marine Corps Recruiter which was scheduled to come to the campus. He said one SDS member dragged an American flag across the quad and for his efforts was beaten up by a couple of members of a new right wing group at the school.

The SDS had planned to protest the number of Negro Marines who have been killed in Vietnam, however the Marine Corps set a Negro Recruiter to the school which really threw water on their plans.

According to CLAY it appears that a real confrontation may be brewing between the conservative and radical students at UCSD. It was also learned that CLAY now has his private pilots license.

It has also been learned that BERRY GODFREY and other members of the Minutemen group may be present at the SMC march and rally on 11/1/70.

Jerome

Date prepared

1/27/71

Date received

11/9/70

Received from (name or symbol number)

~~Informant~~
SD 1155-R

Received by

SA Steven L. Christensen

Method of delivery (check appropriate blocks)

in person by telephone by mail orally recording device written by Informant

If orally furnished and reduced to writing by Agent:

Date

Dictated

to

Transcribed

Authenticated by Informant

Date of Report

11/9/70

Date(s) of activity

Week ending
11/9/70

Brief description of activity or material

MM activities

File where original is located if not attached

170-286A

* INDIVIDUALS DESIGNATED BY AN ASTERISK (*) ONLY ATTENDED A MEETING AND DID NOT ACTIVELY PARTICIPATE. VIOLENCE OR REVOLUTIONARY ACTIVITIES WERE NOT DISCUSSED.

Information recorded on a card index by _____ on date _____

Remarks:

157-1798 (MM)

170-286A-54

100-14356 (Peter Ruppinger)

100-14293 (Bill Clay)

100-12464 (Melvin Crain)

~~100-~~ (Kenneth Goff) index

100-15000 (LARGO)

Block Stamp

170-286A-54

SEARCHED <input checked="" type="checkbox"/>	INDEXED <input checked="" type="checkbox"/>
SERIALIZED <input checked="" type="checkbox"/>	FILED <input checked="" type="checkbox"/>
JAN 13 1971	
FBI - SAN DIEGO	

[Signature]

On 11/9/70
By Jerome

I was in contact with PETER REPLINGER last Saturday. He told me he has agreed to take charge of all the Minutemen records which are presently being kept by BERRY GODFREY. PETER is getting ready for his upcoming wedding and consequently has not been to active lately.

I have noticed that someone has been painting a number of pro-Minutemen slogans on bridge abutments and overpasses around the La Mesa and El Cajon area lately.

I had a chance to talk to BILL CLAY this morning. He is still upset about MELVIN CRAIN. He thinks CRAIN is behind a large part of the left wing activities in the county. He said he believes CRAIN has a lot of weapons and ammunition stored away on his Hollyoaks Ranch in Harbison Canyon.

CLAY also mentioned that KENNETH GOFF was in town yesterday. He said GOFF was and probably still is a close associate of DE PUGH. CLAY said GOFF is sort of a religious fanatic. He suspects GOFF may have concealed DE PUGH for awhile when DE PUGH was in hiding. He said GOFF was here to speak to a group of right wing people and said about 40 individuals attended the speech.

CLAY said GOFF told him of the existance of a left wing revolutionary army which is operating in this country. He said this army uses the name "Largo" and allegedly obtains its orders and instructions by code through a TV Program named "Dark Shadows". He said the code used is supposed to be based on the sixth and seventh chapters of one of the books of Moses in the bible, which is somehow inserted into the TV program's script. He also said there have been references to "Largo"

Jerome

in recent issues of "News Week" and "Saga" magazines.
If he can find out what issues it was in, he will try
and get them.

Jerome

Date prepared

1/27/71

Date received

11/10/70

Received from (name or symbol number)

Informant
SP 1155-R

Received by

SA Steven L. Christensen

Method of delivery (check appropriate blocks)

in person by telephone by mail orally recording device written by Informant

If orally furnished and reduced to writing by Agent:

Dictated _____ to _____
Date _____

Transcribed _____

Authenticated by Informant _____

Date of Report

11/10/70

Date(s) of activity

11/10/70

Brief description of activity or material

MM activities

File where original is located if not attached

170-286A

INDIVIDUALS DESIGNATED BY AN ASTERISK (*) ONLY ATTENDED A MEETING AND DID NOT ACTIVELY PARTICIPATE. VIOLENCE OR REVOLUTIONARY ACTIVITIES WERE NOT DISCUSSED.

Information recorded on a card index by _____ on date _____

Remarks:

- 157-1998 (MM)
- 170-286A-55
- 100-14016 (Bettie Houghton)
- 100-14819 (Godfrey)
- 100-14296 (Lou Conde)
- 100-14293 (Clay)
- 100-157-2224 (Isaac Cantrell)
- 100-14297 (Davis)

170-286A-55
Block Stamp

SEARCHED INDEXED
SERIALIZED FILED
JAN 27 1971
FBI - SAN DIEGO
[Signature]

On 11/10/70
By Jerome

Attached are copies of some new Minutemen stickers and posters which the local group has been putting out. They are supposedly printed by Alex Rapid Print in La Mesa. They are being mailed out to many people and are also handed out locally around town.

It is known that BETTIE HOUGHTON was in contact with BARRY GODFREY last night. She was very excited about the posters and stickers and said she was very glad to see some activities getting started. She said she is reorganizing some of her contacts and group and said that the new posters and stickers had caused such a flury in town that the whole Minutemen organization might really get going again. She said LOU CONDE had apparently received some of the stickers and posters and was excited about them. It looks as though there are many people just sitting around waiting for something like this to happen so they could get involved.

It was also learned that BETTIE Gave GODFREY some plates with which to make some big Minutemen posters. She also said she has nearly 500 negatives which can be used to make plates for printing posters and leaflets.

I had a chance to talk to BILL CLAY again. He maintained that there may have been some connection between DAVIS and ISSAC CANTRELL awhile ago. CANTRELL is the one who was arrested by local and federal authorities for unlawful possession and manufacture of automatic weapons.

Jerome

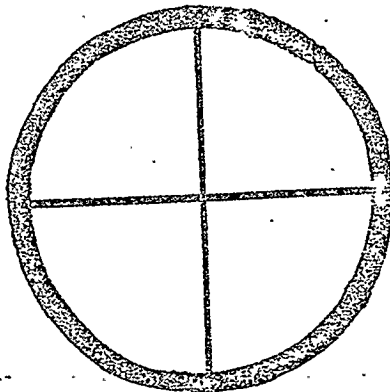

**COMMUNIST TRAITORS
BEWARE**

**EVEN NOW THE CROSS-HAIRS
ARE AT THE BACK
OF YOUR NECK** AM

HELP STOP COMMUNISM



JOIN THE
"Minutemen"

An organization of loyal Americans
dedicated to the preservation of both
national and individual freedom.

Insist on a strong stand by our own government
against communism-- in Cuba as well as in Vietnam.
Demand that we stop sending supplies to Russia and
her communist satellites while American boys are
being killed in Vietnam by Russian bullets-- clean
out the traitors and parasites in our own federal
bureaucracy. Be prepared to help stop armed communist
invasion or violent revolution.

For further information on the Minutemen
organization, send a stamped self-addressed envelope to

Date prepared

1/27/71

Date received

11/18/70

Received from (name or symbol number)

Informant
SD 1155-R

Received by

SA Steven L. Christensen

Method of delivery (check appropriate blocks)

in person by telephone by mail orally recording device written by Informant

If orally furnished and reduced to writing by Agent:

Date

Dictated _____ to _____

Transcribed _____

Authenticated by Informant _____

Date of Report

11/18/70

Date(s) of activity

11/18/70

Brief description of activity or material

Info re James Richard Buss
and Stephen Smith

File where original is located if not attached

170-286A

* INDIVIDUALS DESIGNATED BY AN ASTERISK (*) ONLY ATTENDED A MEETING AND DID NOT ACTIVELY PARTICIPATE. VIOLENCE OR REVOLUTIONARY ACTIVITIES WERE NOT DISCUSSED.

Information recorded on a card index by _____ on date _____

Remarks:

67-7967
170-286A-56
157-1798 (MM)
100-14296 (Conde)
100-14302 (Vejvoda)
100-14301 (Rupflinger)
100-15400 (Jerry Geyer)

Index: Colonel Shimp;
Daniel Predovich;
Digiscan to 67-7967
"Benny the Barber" to
157-1798

170-286A-56
Block Stamp

SEARCHED _____ INDEXED _____
SERIALIZED 12 FILED _____
JAN 27 1971
FBI - SAN DIEGO

[Handwritten signature]

NOVEMBER 18, 1970
BY JEROME

The photo of JAMES RICHARD BUSS is totally unfamiliar to me and I don't believe I have ever seen this individual before. His name is also not familiar to me.

I was fairly well-acquainted with STEPHAN SMITH. He was in the San Diego area for a period of approximately a year and left six to eight months ago. I was told that he went back north, which I assume to mean Los Angeles or San Francisco.

SMITH was married and lived with his wife at Rancho Bernardo while he was in this area. He was very involved in the Right vs Left confrontation, which took place in Poway last year over the make up of the Poway School Board. He was involved there with Colonel SHIMP, the NORMANS, and other people who were opposed to DANIEL PREDOVICH as School Board Chairman and some of whom who were considering ways of getting rid of PREDOVICH.

While SMITH was in this area, he was closely associated with known members of the Minutemen organization, such as MICHAEL VEJBODA, PAUL RUPLINGER and LOU CONDE. I do not know if SMITH is or was a member of the Minutemen organization, but if not, he was not a member in name only as he appeared to be in total agreement with the far Right extremist, radical, political philosophies of VEJBODA, RUPLINGER and CONDE. SMITH's wife was also extremely Right Wing and on one occasion helped pass out Minutemen organization leaflets. SMITH was involved as a partner with LOU CONDE in a business, which was named DIGISCAN. DIGISCAN was supposed to have been an electronics research and manufacturing outfit, the main purpose of which was to develop and sell a police communications system whereby each individual police officer could, at all times, be in constant touch with some police base station. SMITH and CONDE apparently had a quarrel about the business and split up, and I believe there may be a law suit pending over ownership of some of the equipment, which belonged to the company.

Jerome

As a sidelight, SMITH would build monitoring and "bugging" devices for a price. He also had electronic equipment for use in searching buildings and other places for hidden electronic monitoring devices or "bugs".

I heard recently that MICHAEL VEJBODA is presently living in Salt Lake City.

There is to be a big gun show in Campo on the weekend of November 21, and 22, 1970, and from the talk I have heard, it sounds as though it will be a regular gathering of the Minutemen organization and other Right Wingers in this area. JERRY GEIER, I know, will be there with weapons to show and sell.

BENNY, the barber who has all the machine guns and rifles in his barber shop, is located on the west side of 30th Street, about 1½ blocks north of El Cajon Boulevard.

Jerome

Date prepared

1/29/71

Date received

11/16/70

Received from (name or symbol number)

SD 1155-R

Received by

SA Steven L. Christensen

Method of delivery (check appropriate blocks)

in person by telephone by mail orally recording device written by Informant

If orally furnished and reduced to writing by Agent:

Date

Date of Report

11/16/70

Dictated

_____ to _____

Date(s) of activity

11/14/70

Transcribed

Authenticated by Informant

Brief description of activity or material

Info re activities of Sam Davis and Peter Ruppinger

File where original is located if not attached

170-286A

* INDIVIDUALS DESIGNATED BY AN ASTERISK (*) ONLY ATTENDED A MEETING AND DID NOT ACTIVELY PARTICIPATE. VIOLENCE OR REVOLUTIONARY ACTIVITIES WERE NOT DISCUSSED.

Information recorded on a card index by _____ on date _____

Remarks:

157-1798 (MM)
170-286A-57
100-14297 (Davis)
100-12464 (Melvin Crane)
100-11920 (Si Casady)
100-7738 (Dorothy Healey Ph)
100-157-1522 (Frank Yacopec)
100-14293 (Bill Clay)
100-14819 (Godfrey)
100-14356 (Peter Ruppinger)
2 - Los Angeles
(1-100 Frank W. Corrigan)

Index: "Doc Robert's"
Frank W. Corrigan

Block Stamp

170-286A-57
SEARCHED [initials]
SERIALIZED [initials]
FEB 1 1971
FBI - SAN DIEGO
[initials]

11/16/70
by JEROME

I was in contact with SAM DAVIS last Saturday evening. For some reason he was quite upset and was talking about making plans for a tactical squad of six or so individuals with which to harass and terrorize left wing sympathizers in the San Diego area. He said he wanted to have a meeting this coming Friday evening to try to map out some strategy. In particular, he seems to want to conduct a raid on MELVIN CRANE's ranch. He said he would shoot the Doberman Pincers CRANE has guarding the place, ransack the house then burn it down.

He was also talking about another place in Harbison Canyon, I will try to get the address later, where he claims Communist Party meetings are being held. Among others, he claims that SI CASADY and DOROTHY HEALEY (phonetic) have been meeting there. He says he wants to raid that place too.

He was also talking about a "Doc Roberts" who he says has many weapons contacts and who may have access to machine guns and hand grenades. He may put me in touch with this person later on.

I have also been talking to FRANK YACOPEC. YACOPEC says he has learned of a possible existence of some bunkers which were buried and abandoned by General PATTON at the start of the second World War. He says the bunkers are supposed to still be full of ammunition and explosives. He claimed he was told of the existence of the bunkers by a former aide of General PATTON. He told me that he, BILL CLAY and BARRY GODFREY may fly up to the location at a later date and look it over. Apparently these bunkers are located somewhere in the desert east of 29 Palms.

I was also in touch with PETER RUPLINGER on Saturday. He stated he has obtained 50 hand grenade fuses and wants to go to Los Angeles to buy 50 hand grenade casings and he will then activate the hand grenades. PETER claimed he has a friend who works at the Frontier Gun Shop in San Diego who is a right wing individuals and is selling unregistered ammunition and firearms. PETER has been carrying a ~~23~~ caliber revolver lately.

22
Jerome

I also learned that SAM DAVIS has an unknown quantity of expendable rocket launchers with rounds which he will sell for \$25 each. He is supposed to be looking for anti-tank weapons and mortars in the hundreds or thousands. DAVIS apparently has a brother who is also very militant and is working with him.

I am supposed to see BETTIE HOUGHTON this evening. She will put out 500 of the new posters and stickers (see attached). The advertising from the posters and stickers has obtained response from as far away as Los Angeles where ~~the~~ a person named FRANK W. CORRIGAN wrote requesting information.

Jerome

*Corrigan's address is 5653 Franklin,
Los Angeles, California.*

Date prepared

1/29/71

Date received

12/1/70

Received from (name or symbol number)

Informant
SD 1155-R

Received by

SA Steven L. Christensen

Method of delivery (check appropriate blocks)

in person by telephone by mail orally recording device written by Informant

If orally furnished and reduced to writing by Agent:

Date

Dictated _____ to _____

Transcribed _____

Authenticated by Informant _____

Date of Report

12/1/70

Date(s) of activity

11/25/70 to
11/27/70

Brief description of activity or material

Contact with Marge McNickles,
Sam Davis & Bill Clay -

File where original is located if not attached

170-286A

* INDIVIDUALS DESIGNATED BY AN ASTERISK (*) ONLY ATTENDED A MEETING AND DID NOT ACTIVELY PARTICIPATE. VIOLENCE OR REVOLUTIONARY ACTIVITIES WERE NOT DISCUSSED.

Information recorded on a card index by _____ on date _____

Remarks:

- 157-1798 (MM)
- 170-286A-58
- 157-1818 (Marge McNickles)
- 100-13832 (Patriotic Party)
- 157- (Daniel T. McNickles) (open lead if no file)
- 100-14293 (Clay)
- 100-14297 (Davis)
- 100-14294 (Howard Clark) (lead if no file)
- 100-14292 (Brinker)
- 152-2010 (Jim Moore)
- 4 - Los Angeles
- 157-242 (Gennie Mower)

Index: ~~Jim Moore~~,
Glenn Jackson,
Dennis Mower, Ed
Andrews, Henning Von
Beck to 157-1798/
Sam Williams to 100-14297

17 (Block Stamp) 170A-58

SEARCHED
SERIALIZED
FEB 11 1971
FBI - SAN DIEGO
J. E. ...

California license MHD 097 registered
to 1964 VW Bus owned by Marshall
Frederic Johnson, 711 - 24th St., Her-
mosa Beach, Calif.

On 12/1/70
By JEROME

I was in contact with MARGE MC NICKLES at Julian last Wednesday and talked to her for about three hours. We discussed DE PUGH's status. She said that representatives of the Minutemen organization and the Patriotic Party have been talking to former Chief of Police REDDIN at Los Angeles alleging that DE PUGH is innocent of the bank robbery conspiracy charges on which he was recently convicted. She said she was told REDDIN is sufficiently convinced of the possibility of DE PUGH's innocence that he may search out evidence in this regard on which to base a program for his television show.

She also talked about a JIM MOORE who she said is in California and is on one of MC NICKLES' mailing list. She also mentioned an older man in Los Angeles named FREED who is a leader of the Patriotic Party. She said that DE PUGH's mother is also a Patriotic Party leader and told me that DE PUGH has asked GLENN JACKSON, of Los Angeles, to resign as co-National Patriotic Party Chairman.

MC NICKLES said that she herself is Secretary-Treasurer of the Western Region of the Patriotic Party which covers 11 states. She said in the event of a split in the Patriotic Party between DE PUGH and JACKSON, she will side with DE PUGH. She said she has the bank account and the membership list for the Western Region of the Patriotic Party in her possession.

She also told me that the Minutemen National Headquarters continues to function under BOB DE PUGH, JR., and RAMONA VAN DE PUGH. She said there is a courier traveling between Los Angeles and the Minutemen National Headquarters weekly.

Jerome

She asked that her son, DAN T. MC NICKLES, a student at San Diego State College, be used at Right Wing activities and made arrangements for me to meet him this evening at 8:00 p.m., in La Mesa.

MC NICKLES told me there is a woman living in the Julian commune and said she has seen others coming and going there. She gave me the license numbers of two more of the cars she has seen at the commune. One was an out of state license, white background with blue figures XVC 316, which was on a dark green car with white racing stripes, possibly a Mustang, which was at the commune on October 11, 1970. The other was a tan over brown Volkswagen bus with California license MHD 097 which was at the commune on November 2, 1970.

On Friday I saw BILL CLAY and told him about MARGE MC NICKLES. I asked him if he thought we should try to use her to re-establish contact with the Minutemen National Headquarters. CLAY said "I don't know. We'll have to ask SAM about that." I was definitely impressed from the way he made the statement that perhaps he has been taking orders in the Minutemen organization from SAM DAVIS all along.

We then went together to see DAVIS and discussed MC NICKLES with him. He said that we should continue talking with MC NICKLES to see what contact with her would produce. CLAY and DAVIS then got to talking about breaking DE PUGH out of jail at Albuquerque and I related to them what MC NICKLES had told me before about going to Albuquerque to visit DE PUGH. CLAY and DAVIS became very upset and jumped all over me because I had not told them about MC NICKLES being there and about knowing the layout of the Albuquerque City Jail.

After this they started talking idly about getting DE PUGH out of prison at Fort Levenworth.

DAVIS then stated he had seen DENNIS MOWLER not too long ago and at that time MOWLER was hiding out a girl who was allegedly a former secretary for DE PUGH. He said MOWLER told him that for some reason DE PUGH had people looking for this girl to kill her and that also she was being sought by the FBI.

Jerome

DAVIS continued talking and indicated the possibility he hold a higher position in the Minutemen organization in the State of California than we previously suspected. He said he has been using the name SAM WILLIAMS in some of his other contacts and Minutemen activities.

CLAY then mentioned a former San Diego area Minuteman named ED ANDREWS who he thought had always been very reliable. He said he had previously understood ANDREWS to be somewhere in the State of Arkansas but said VIC WALTON had told him that ANDREWS was back at Ramona, California, some time ago.

They also talked about HOWARD CLARK as a reliable Minuteman member. He also apparently lives at Ramona and is employed at Convair. MC NICKLES is also well acquainted with CLARK and they said we should use CLARK as a reference to MC NICKLES to gain her confidence.

CLAY and DAVIS want to have another meeting soon for the purpose of setting up a schedule or list of targets in the San Diego area to hit in the event it appears that a communist or other totalitarian takeover in this country appears imminent. From my contact with CLAY and DAVIS it appears that there has been considerable improvement in the communications and coordination among the Right Wings in this area.

Additionally, regarding my contact with MC NICKLES, she told me she is Neo-Nazi. She also said she is in contact with JOSEPH BRINKER and also said that HENNING VON BECK is in town. She said he is the son of a General VON BECK who was in the German army and was executed at the Nurenberg trials. She said he told her that last week some one fired a rifle bullet through the windshield of his automobile and regularly gets letters from Jews announcing they are out to get him.

She also told me that the local telephone installer at Julian, a man 40 - 45 years old, is also a Minuteman and that he checks her telephone for her to determine if it is being bugged.

Jerome

Date prepared
1/29/71

Date received
12/2/70

Received from (name or symbol number)
informant
SD 1155-R

Received by
SA Steven H. Christensen

Method of delivery (check appropriate blocks)
 in person by telephone by mail orally recording device written by Informant

If orally furnished and reduced to writing by Agent:
Date
Dictated _____ to _____
Transcribed _____
Authenticated by Informant _____

Date of Report
12/2/70

Date(s) of activity
12/2/70

Brief description of activity or material
Info re Anthony Kao in
Kailua, Hawaii

File where original is located if not attached
170-286A

* INDIVIDUALS DESIGNATED BY AN ASTERISK (*) ONLY ATTENDED A MEETING AND DID NOT ACTIVELY PARTICIPATE. VIOLENCE OR REVOLUTIONARY ACTIVITIES WERE NOT DISCUSSED.

Information recorded on a card index by _____ on date _____

Remarks:

100-0- (Anthony Kao)
170-286A-59
2 - Honolulu

Index: Fashion
wig imports to
100-0. Also
Stephen Sued

170-286A-59
Block Stamp

SEARCHED [initials]
SERIALIZED [initials]
FEB 1 1971
FBI - SAN DIEGO
[signature]

On 12/2/70
By JEROME

My parents, who just recently returned from Hawaii, told me about a person named ANTHONY KAO they had been in contact with while in Hawaii. They said KAO owns and operates a business named Fashion Wig Imports which is located in the Ala Moana Building on Wanao Place in Kailua, Hawaii.

They said KAO made a number of statements which were anti-United States and pro-communist China in nature. They said KAO, who is Chinese, is closely connected with many Chinese communist businessmen and is currently trying to act as a sponsor to help immigrate two men from Taiwan into the United States.

They also said he ^{knows} ~~lives with~~ another ~~man~~ ^J man named STEPHEN SUED, of Yugoslav nationality, who they said was trying to run for some public office in the recent elections in Hawaii. *Sued allegedly makes regular trips to Yugoslavia. J*

Jerome

Date prepared

1/29/71

Date received

12/3/70

Received from (name or symbol number)

SD 1153-R

Received by

SA Steven L. Christensen

Method of delivery (check appropriate blocks)

in person by telephone by mail orally recording device written by Informant

If orally furnished and reduced to writing by Agent:
Date

Date of Report

12/3/70

Dictated _____ to _____

Date(s) of activity

Transcribed _____

Authenticated by Informant _____

12/2/70

Brief description of activity or material

Info re Norman's at
Poway + John Bush

File where original is located if not attached

170-286A

* INDIVIDUALS DESIGNATED BY AN ASTERISK (*) ONLY ATTENDED A MEETING AND DID NOT ACTIVELY PARTICIPATE. VIOLENCE OR REVOLUTIONARY ACTIVITIES WERE NOT DISCUSSED.

Information recorded on a card index by _____ on date _____

Remarks:

157-1798 (MM)
170-286A-60
100-15355 (John Bush)

170-286A-60
Block Stamp

SEARCHED [initials]
SERIALIZED [initials]
FEB 1971
FBI - SAN DIEGO
[Handwritten signature]

On 12/3/70
By JEROME

I was in contact with the NORMAN's from Poway yesterday, the father and son. I learned that the father is a landscaper and that he has access to large quantities of ammonium nitrate. The son is a student at Mesa College. Both seemed very willing to help out in any Right Wing activities in this area.

I was also in contact with JOHN BUSH last night. He is still wheeling and dealing in surplus military goods and especially military manuals. I acquired from him a Special Forces Manual on Air Drop Methods and Codes.

Jerome

Date prepared

1/29/71

Date received

12/11/70

Received from (name or symbol number)

Information
SD 1155-R

Received by

SA Steven L. Christensen

Method of delivery (check appropriate blocks)

in person by telephone by mail orally recording device written by Informant

If orally furnished and reduced to writing by Agent:

Date

Dictated _____ to _____

Transcribed _____

Authenticated by Informant _____

Date of Report

12/11/70

Date(s) of activity

12/11/70

Brief description of activity or material

Info. re Gerald Smith *
Morris J. Starsky

File where original is located if not attached

170-286A

* INDIVIDUALS DESIGNATED BY AN ASTERISK (*) ONLY ATTENDED A MEETING AND DID NOT ACTIVELY PARTICIPATE. VIOLENCE OR REVOLUTIONARY ACTIVITIES WERE NOT DISCUSSED.

Information recorded on a card index by _____ on date _____

Remarks:

157-1798

170-286A-61

105-134 (Gerald L. K. Smith)

100-157-25 (National Socialist White Peoples Party)

157-196 (White Citizens Council)

100-15337 (Starsky)

170-286-61

SEARCHED [] INDEXED []
SERIALIZED [] FILED []
FEB 1 1971
FBI - SAN DIEGO
Christensen

On 12/11/70
By JEROME

I am very familiar with the name GERALD L. K. SMITH. He has been operating around the Southern California area for some time and is generally considered to be a finatical extreme right wing militant individual and is kind of nutty. He is or has been involved in the National Socialist White People's Party and in the San Diego White Power Council.

*Attached is copy of Minuteman leaflet
put out today on Morris J. Starsky*

Jerome

News Briefs

STUDENT GOVERNMENT

COMMITTEE ON COMMITTEES - Applications for three student positions on Academic Honesty Committee are open. Applications available in AD126 and AS Offices. Deadline Monday.

COUNCIL - Arts and letters position open. Applications available in the Organizations Office. Applications due Dec. 15, interviews 3 p.m. Dec. 16.

HEALTH SERVICES BOARD - Meeting 11 Monday. Room 231, Health Services Bldg. Open to all students.

INTERFRATERNITY COUNCIL - Presidents meeting 10 p.m. today, Rooms B or G, Aztec Center. Del Snd pictures will be taken. Election of IPC rush chairman. Important, please attend.

PUBLICATIONS BOARD - Meeting 11, Tuesday,

ignore it. I have met the enemy and it is me. Now, at the count of three, I will awaken and return to normal. One "Two..." Our office P5113. Meetings 11 a.m. Tuesdays, Rooms K and L, Aztec Center.

EDUC. ASSOCIATION - Meeting 11 a.m. Dec. 15, SS337.

FOLK DANCING - Sunday night 7-9, Dec. 13, Room C, Aztec Center. Greek, Israeli, Serbian, American, and many more dances. If you enjoy dancing and meeting new people, make yourself known. Everyone welcome. Bring a friend. It's free.

GAY LIBERATION FRONT - Due to weather, Sunday's Gay in will be held at 6851 Alvarado Rd., Apt 14.

HOUSING CENTER - Bicycle auction, 10 a.m. Saturday, Aztec Center.

MODERN DANCE CLUB - Weekly meeting 11 a.m. Thursdays, WPE. Everyone welcome. No experience necessary.

MORRIS J STARSKY LIVES
AT 6851 ALVARADO RD.
APT. 14

Aug. 15, 1970

Controversial Professor Now At S.D. State

TEMPE, Ariz. (AP) - Dr. Morris Starsky, controversial former assistant professor at Arizona State University, is teaching as a visiting lecturer at San Diego State, the State Press has reported.

The chairman of the philosophy department at San Diego State, Dr. Patricia Crawford, has confirmed that Starsky was hired, as of Sept. 1, on a one-year basis to teach two courses, logic and 20th Century philosophy.

The ASU student newspaper said Starsky expressed fears in a telephone interview that an attempt would be made to jeopardize his position at the California college by informing the administration of his past political activities at Arizona State.

Starsky, an admitted Socialist, was placed on one year's terminal sabbatical leave by the Board of Regents last June after dismissing a class to address a rally at the University of Arizona. The faculty committee on academic freedom and tenure had recommended that the charges brought against him be dismissed.

The student newspaper quoted Starsky as saying it was "nice to be away from ASU, away from the public view." The school, he said, "is a fishbowl to the Arizona legislature" with "political control extremely direct since the legislature meets in Phoenix."

Starsky has filed a federal court suit seeking to regain his position as an assistant professor of philosophy.

12-1-76 SD Office
Arizona Treatment

Ordinarily the administrators of San Diego State College and the institution's Board of Trustees would not pay much attention to a banquet speaker extolling the 42nd anniversary of "The Militant" - the Socialist Workers' Party newspaper.

We hope that they did last weekend. The speaker was Morris J. Starsky, a dedicated Marxist who was fired from Arizona State University for his active advocacy of far left causes.

Mr. Starsky, now a philosophy professor at San Diego State College, evidently has not changed his stripes. We suggest to San Diego State officials that they consider him a prime candidate for the Arizona treatment.

Perome

Date prepared

1/27/71

Date received

1/4/71

Received from (name or symbol number)

SD 1155-R

Received by

SA Steven L. Christensen

Method of delivery (check appropriate blocks)

in person by telephone by mail orally recording device written by Informant

If orally furnished and reduced to writing by Agent:

Date

Dictated _____ to _____

Transcribed _____

Authenticated by Informant _____

Brief description of activity or material

MM info

Date of Report

1/4/71

Date(s) of activity

1/3/71

File where original is located if not attached

170-286A

* INDIVIDUALS DESIGNATED BY AN ASTERISK (*) ONLY ATTENDED A MEETING AND DID NOT ACTIVELY PARTICIPATE. VIOLENCE OR REVOLUTIONARY ACTIVITIES WERE NOT DISCUSSED.

Information recorded on a card index by _____ on date _____

Remarks:

- 157-1798 (MM)
- 170-286A-62
- 100-15356 (George Hoover)
- 100-15337 (Starsky)
- 100-14296 (Conde)
- *100-157-1871 (Frank Yacofec)
- 100-100-15400 (Levy Geyer)

170-286A-62
Block Stamp

SEARCHED [initials]
SERIALIZED [initials]
FEB 1 1971
FBI - SAN DIEGO
[Signature]

REPORT BY JEROME

JANUARY 4, 1971

He was in contact with GEORGE HOOVER yesterday who apparently has not been doing much of anything. He also saw JERRY GEIER last night who claimed he has made contact with a Minutemen group at Los Angeles which is involved in buying and selling weapons. He told many about some new Minutemen business cards which are coming out of Los Angeles. We got around to talking about hand grenades and GEIER said that although he did not openly solicit hand grenades for money, he would obtain some for money if he happened to run across any.

I am not aware of anyone connected with the Minutemen organization placing Minutemen stickers and posters around MORRIS STARSKY's apartment house or on his car. However, people like LOU CONDE, FRANK YACOPEC and the RUPLINGERS are always good suspects in things like that.

Jerome

Date prepared

1/28/71

Date received

1/7/71

Received from (name or symbol number)

Informant
SD 1155-R

Received by

SA Steven L. Christensen

Method of delivery (check appropriate blocks)

in person by telephone by mail orally recording device written by Informant

If orally furnished and reduced to writing by Agent:

Date

Dictated _____ to _____

Transcribed _____

Authenticated by Informant _____

Date of Report

1/7/71

Date(s) of activity

1/5/71

Brief description of activity or material

Info re MM activities

File where original is located if not attached

170-286A

* INDIVIDUALS DESIGNATED BY AN ASTERISK (*) ONLY ATTENDED A MEETING AND DID NOT ACTIVELY PARTICIPATE. VIOLENCE OR REVOLUTIONARY ACTIVITIES WERE NOT DISCUSSED.

Information recorded on a card index by _____ on date _____

Remarks:

- 157-1798 (MM)
- 170-286A-63
- 100-15356 (George Hoover)
- 100-14297 (Davis)
- 100-14610 (Stan McCade)
- 100-157-1870 (Frank Yacopec)
- 100-14819 (Godfrey)
- 100-15400 (Jerry Geyer)
- 100- (Roger Willis) Prev. opened
- 100-14293 (Clay)
- 100-15355 (Jerry Busch)

Block Stamp

SEARCHED INDEXED
 SERIALIZED FILED
 FEB 1971
 FBI - SAN DIEGO

Christensen

170-286A-63

REPORT BY JEROME

JANUARY 7, 1971

I was talking with GEORGE HOOVER day before yesterday. We discussed an idea which he and SAM DAVIS have had regarding setting up a Civil War Confederate skirmish group similar to other such groups which have been established in other parts of the country. This group will be set up by HOOVER, DAVIS, STAN McDADE, (LNU) MARTINI of the Accuracy Gun Shop, FRANK YACOPEC and BARRY GODFREY. It is expected as many as 50 or 60 other individuals may join the skirmish group, some who will be rightwing oriented people and may who will be just plain gun nuts. These will include JERRY GEIER, ROGER WILLIS and others probably including some from the Patch and Ball Gun Shop crowd.

I have also learned that GEORGE HOOVER and SAM DAVIS have three operational Civil War field artillery pieces which are located on ROGER WILLIS' Gunsmoke Ranch property in Harbison Canyon and may actually belong to him. STAN McDADE is building a 4th artillery piece. He has the gun carriage assembly and has ordered the barrel for the weapon..

Jerome

According to HOOVER, the beauty of organizing such a skirmish group is that it will allow the right wingers and Minutemen to use the group as an above ground organization and to openly drill and train with weapons. Members would have their own uniforms and the organization would be set up in a military fashion with officers, ranks, etc., assigned to the members. Persons joining the organization will be protected from police and other outside harassment by being assigned the name of an actual Civil War officer or soldier to use while they are participating in the organization's activities. The existence of the organization will also give the right wingers an excuse to have large quantities of black powder and percussion caps on hand to use for their weapons.

In addition the organization could be used to provide an honor guard to be present at local appearances of right wing speakers and to set up counter-demonstrations against left wing activities.

This skirmish group would be controlled and directed by an underground nucleus of 6 or 8 solid Minutemen members who are not generally known to other members of the skirmish group.

HOOVER and DAVIS are apparently becoming less interested in BILL CLAY as a member and participant in right

Jerome

wing activities. According to them, he is too busy now
adays with his own personal affairs to be of much use.
For this reason, they have said they don't want him in the
underground group of Minuteman members who will direct
the Civil War skirmish.

It has come to my attention that JERRY BUSCH
has fallen out of favor with most of the Minutemen members
who do not like or trust him. SAM DAVIS has even threatened
to shoot him. GEORGE HOOVER still likes him though and
BUSCH spends most of his weekends at the Gunsmoke Ranch with
HOOVER and WILLIS. Could there be a romance brewing?

Jerome

Date prepared

1/28/71

Date received

1/13/71

Received from (name or symbol number)

SD 1155-R

Received by

SAS Stewart L. Christensen

Method of delivery (check appropriate blocks)

in person by telephone by mail orally recording device written by Informant

If orally furnished and reduced to writing by Agent:

Date

Dictated _____ to _____

Transcribed _____

Authenticated by Informant _____

Date of Report

1/13/71

Date(s) of activity

1/12/71

Brief description of activity or material

Info re Paul Ruppinger

File where original is located if not attached

170-286A

* INDIVIDUALS DESIGNATED BY AN ASTERISK (*) ONLY ATTENDED A MEETING AND DID NOT ACTIVELY PARTICIPATE. VIOLENCE OR REVOLUTIONARY ACTIVITIES WERE NOT DISCUSSED.

Information recorded on a card index by _____ on date _____

Remarks:

100-14301 (Ruppinger)
100-14296 (Conde)
170-286A-64

Index: Virtue In America

170-286A-64
Block Stamp

SEARCHED _____ INDEXED _____
SERIALIZED 13 FILED 7
FEB 1 1971
FBI - SAN DIEGO
Christensen

REPORT BY JEROME

JANUARY 13, 1971

I was talking to PAUL RUPLINGER yesterday. He told me he is trying to revitalize the Virtue in America Group (VIA). He said he has been talking to LOU CONDE in an attempt to gain his participation and support for VIA. He also said if he is successful with VIA he may possibly go in with the skirmish group which GEORGE HOOVER and SAM DAVIS have been talking about setting up.

Jerome

Date prepared

1/29/71

Date received

1/13/71

Received from (name or symbol number)

*Informant
SD 1155-R*

Received by

SA Steven Christensen

Method of delivery (check appropriate blocks)

in person by telephone by mail orally recording device written by Informant

If orally furnished and reduced to writing by Agent:

Date

Date of Report

1/13/71

Dictated _____ to _____

Date(s) of activity

Transcribed _____

Authenticated by Informant _____

1/13/71

Brief description of activity or material

*Info re Mang McNickles and
MM*

File where original is located if not attached

170-286A

* INDIVIDUALS DESIGNATED BY AN ASTERISK (*) ONLY ATTENDED A MEETING AND DID NOT ACTIVELY PARTICIPATE. VIOLENCE OR REVOLUTIONARY ACTIVITIES WERE NOT DISCUSSED.

Information recorded on a card index by _____ on date _____

Remarks:

*157-1798 (MM)
170-286A-65
157-1818 (McNickles)*

Index: Jesse Stephens

Block Stamp

170-286A-65

SEARCHED <i>JS</i>	INDEXED <i>JS</i>
SERIALIZED <i>JS</i>	FILED <i>JS</i>
FEB 1 1971	
FBI - SAN DIEGO	

Christensen

On 1/13/71
By JEROME

I was at Julian today talking to MARGE MC NICKLES. She said she had sent a letter to one of my Post Office Boxes asking me to come and see her. She said it looked as though there had been another split in the Minutemen organization, and showed me a bulletin which she had received from what looks like a new Minutemen group. The bulletin was printed on the original Minutemen letterhead paper and was post marked December 15, 1970. She said she received the bulletin about a week ago.

Regarding the bulletin, MC NICKLES said that in the past there was always talk about DE PUGH and other people in the Minutemen organization regarding an Executive Committee of advisors to DE PUGH. According to the bulletin, it had been sent out by that Executive Committee and announced that during the month of December of 1970, no date given, there had been a meeting of Regional Coordinators of the Minutemen organization at Chicago, Illinois. The bulletin said the Executive Committee was gratified at the large attendance at the meeting and went on to announce that control of the Minutemen organization was being taken away from DE PUGH and the rest of the National Headquarters Group at Norborne, Missouri. The bulletin said this action was being taken as it had been learned that funds of the Minutemen organization had been mis-used, that hallucinatory drugs had been purchased and that effective leadership was lacking at the Norborne Headquarters. *

The bulletin said that DE PUGH and his associates should no longer be considered as part of the Minutemen organization. The bulletin advised that all Minutemen literature which had not been copyrighted was being re-printed and was always available for distribution.

Jerome

She said the copyrighted Minutemen literature was being reviewed for changes so as to avoid the copyright and would be re-printed.

The bulletin also advised that as a result of the December meeting the country had been divided into ten regions with a Regional Coordinator appointed for each. The bulletin said that the Regional Coordinator would be the individual member's contact with the National Headquarters. The bulletin had a return address of Post Office Box 896, Elgin, Illinois, with a note that the second address appearing on the bulletin was that of the receiving members Regional Coordinator. The note went on to say that if no second address appeared on the bulletin the receiving member was to send all Minutemen organization mail to the Elgin, Illinois, address from where it would be forwarded to the Regional Coordinator. There was no second address on MC NICKLES' copy of the bulletin.

Enclosed with the bulletin were a number of the original Minutemen report forms which are to be filled out and returned. Also enclosed were a number of the original Minutemen application forms which are supposed to be distributed to interested persons.

MC NICKLES told me she has heard of several other people (no names given) in our area who also received the bulletin. She said, however, that apparently none of the JOHN ZEMANEC-GLENN JACKSON group at Los Angeles got them.

With regard to DE PUGH, MC NICKLES told me that the charges against him in the State of Washington have been thrown out of court for lack of evidence. MC NICKLES said she communicates regularly with DE PUGH's wife and received a letter from her not too long ago which requested more money for DE PUGH's legal defense. She said, however, there has been no visible action in this regard and pointed out that the above described bulletin implied that DE PUGH's wife is "blowing" the money which is being received for his defense.

Jerome

She said she has also heard a rumor to the effect that DE PUGH's wife is running around on him while he is in prison, but she said she does not believe this is true.

MC NICKLES said DE PUGH's wife had previously mentioned a person named JESSE STEPHENS who may possibly be connected with the group at Elgin, Illinois.

She said STEPHENS supposedly started a Right Wing group some years ago, possibly in the Northwest but was never recognized by DE PUGH.

She said she does not know if STEPHENS is actually connected with the Elgin, Illinois, group.

I will send a letter to the group at Elgin, Illinois, regarding what their plans are. I will use the name JERRY MORAN and the Post Office Box Number 76 at Spring Valley, California.

Jrome

Date prepared
1/28/71

Date received
1/14/71

Received from (name or symbol number)
SD 1155-R

Received by
SA Steven Christense

Method of delivery (check appropriate blocks)

in person by telephone by mail orally recording device written by Informant

If orally furnished and reduced to writing by Agent:
Date

Date of Report
1/14/71

Dictated _____ to _____

Date(s) of activity
1/14/71

Transcribed _____

Authenticated by Informant _____

Brief description of activity or material

Info re Paul Ruppinger &
Venceremos Brigade

File where original is located if not attached
170-286A

* INDIVIDUALS DESIGNATED BY AN ASTERISK (*) ONLY ATTENDED A MEETING AND DID NOT ACTIVELY PARTICIPATE. VIOLENCE OR REVOLUTIONARY ACTIVITIES WERE NOT DISCUSSED.

Information recorded on a card index by _____ on date _____

Remarks:

100-14301 (Ruppinger)
170-286A-66
105-7128 (VB)
100-14293 (Clay)

170-286A-66

Block Stamp
SEARCHED _____ INDEXED _____
SERIALIZED 13 FILED 13
FEB 15 1971
FBI - SAN DIEGO
Christense

ON JANUARY 14, 1971, BY JEROME

I was contacted by PAUL REPLINGER this evening. He is planning some protest activities regarding Mayor CURRAN's announcement in today's "San Diego Union" naming tomorrow, January 15, 1971, as MARTIN LUTHER KING Day in San Diego. It was learned that REPLINGER is making up some dummies of Mayor CURRAN and MARTIN LUTHER KING in his basement which will be hung in elegy from the San Diego County Administration Building tomorrow morning. It was also learned that REPLINGER has lined up about 200 persons to make telephone calls to the City switchboard tomorrow morning for the purpose of tying the switchboard up for as long a period of time as possible.

I also learned from BILL CLAY last night there is to be a speech at UCSD on Sunday, January 17, 1971, at 7:30 p.m. on the Venceremos Brigade. I will get more details tomorrow.

Jerome

Date prepared

1/28/71

Date received

1/15/71

Received from (name or symbol number)

Informant
SD 1155-R

Received by

SA Steven L. Christensen

Method of delivery (check appropriate blocks)

in person by telephone by mail orally recording device written by Informant

If orally furnished and reduced to writing by Agent:
Date

Dictated _____ to _____

Transcribed _____

Authenticated by Informant _____

Date of Report

1/15/71

Date(s) of activity

1/15/71

Brief description of activity or material

Info re Venceremos
Brigade

File where original is located if not attached

170-286A

* INDIVIDUALS DESIGNATED BY AN ASTERISK (*) ONLY ATTENDED A MEETING AND DID NOT ACTIVELY PARTICIPATE. VIOLENCE OR REVOLUTIONARY ACTIVITIES WERE NOT DISCUSSED.

Information recorded on a card index by _____ on date _____

Remarks:

105-9128 (UB)
170-286A-67

Index: Revolutionary
Action Caucus

170-286A-67
Block Stamp

SEARCHED INDEXED
SERIALIZED FILED
FEB 15 1971
FBI - SAN DIEGO
Christensen

ON JANUARY 15, 1971, BY JEROME

I obtained a copy of a leaflet advertising a speech on the Venceremos Brigade at UCSD on January 17, 1971. The leaflet invites people to come to hear about Cuba "after the revolution" from people who have gone on the Venceremos Brigades. The speech is to take place at 7:30 p.m. in Room MC 201 and indicated there would be speakers and slides. According to the leaflet, it was put out by a group named the Revolutionary Action Caucus.

Jerome

Date prepared
1/28/71

Date received
1/18/71

Received from (name or symbol number)
~~SP 1158-R~~

Received by
S.A. Steven L. Christensen

Method of delivery (check appropriate blocks)
 in person by telephone by mail orally recording device written by Informant

If orally furnished and reduced to writing by Agent:
Date _____
Dictated _____ to _____
Transcribed _____
Authenticated by Informant _____

Date of Report
1/18/71

Date(s) of activity
1/18/71

Brief description of activity or material
Info re Lou Conde, Geo. Hoover
Sam Davis, etc.

File where original is located if not attached
170-286A

* INDIVIDUALS DESIGNATED BY AN ASTERISK (*) ONLY ATTENDED A MEETING AND DID NOT ACTIVELY PARTICIPATE. VIOLENCE OR REVOLUTIONARY ACTIVITIES WERE NOT DISCUSSED.
 Information recorded on a card index by _____ on date _____

Remarks:
100-14296 (Conde)
170-286A-68
105- (Alpha 66) Open Deal
100-14297 (Davis)
100-15356 (George Hoover)
100- (Roger Willis) Open Deal
100-14301 (Ruffinger)

Block Stamp: 17-286A-68

SEARCHED INDEXED
SERIALIZED FILED
FEB 19 1971
FBI - SAN DIEGO
Christensen

ON JANUARY 18, 1971, BY JEROME

I have not been in contact with LOU CONDE in some-time; however, I understand he is still politically active especially in the group named Taxpayers Concerned. PAUL REPLINGER is still in regular contact with CONDE.

CONDE has always had a reputation as a "blabber mouth", but actually only talks about little things which are not very important. CONDE is a clever, dynamic, ambitious and hardworking person. He has a lot of money and is very willing to put some of it into right wing activities.

CONDE has many Cuban exile contacts and is a Cuban himself. In particular, he is close to the Alpha 66 group and can get them out to do things for him.

CONDE is in very tight with the local tuna boat association and I would imagine he also has many contacts among the shrimpers and tuna sievers. This is because he has a marine engine and shipfitting business and does much work for the fishing boats.

It is entirely likely that CONDE may be involved in some way with illegal arms shipments on some of these fishing boats between here and some Latin American countries. If this is happening, I doubt that the weapons are coming to the United States through the Latin American countries, but are probably being purchased here and shipped to Cuban guerrilla organizations in Central and South America. It is also possible that CONDE may secretly be doing some work to arm some of the tuna boats to protect them against seizure by such countries as Peru and Ecuador. He mentioned something about this to me about a year ago.

It looks as though I may be going to the Gunsmoke Ranch this coming weekend. They're going to have a pistol shoot there with quite a few people attending. Last weekend they had a shotgun shoot at skeet. The group at the Gunsmoke

Jerome

Date prepared

1/28/71

Date received

1/18/71

Received from (name or symbol number)

SD 1125-R

Received by

SA Steven L. Christensen

Method of delivery (check appropriate blocks)

in person

by telephone

by mail

orally

recording device

written by Informant

If orally furnished and reduced to writing by Agent:

Date

Date of Report

1/18/71

Dictated _____ to _____

Transcribed _____

Authenticated by Informant _____

Date(s) of activity

1/18/71

Brief description of activity or material

Info re Frank Yacopac

File where original is located if not attached

170-286A

* INDIVIDUALS DESIGNATED BY AN ASTERISK (*) ONLY ATTENDED A MEETING AND DID NOT ACTIVELY PARTICIPATE. VIOLENCE OR REVOLUTIONARY ACTIVITIES WERE NOT DISCUSSED.

Information recorded on a card index by _____ on date _____

Remarks:

~~100-157-1536~~ (Frank Yacopac)

170-286A-69

100-14819 (Godfrey)

100-14356 (Peter Rappinger)

157-1798 (MM)

100-15133 (Jerry Tartaglio)

Index: Jerry Tartaglio
to 157-1798

170-286A-69

Block Stamp

SEARCHED <input checked="" type="checkbox"/>	INDEXED <input checked="" type="checkbox"/>
SERIALIZED <input checked="" type="checkbox"/>	FILED <input checked="" type="checkbox"/>
FEB - 13/71	
FBI - SAN DIEGO	

[Handwritten signature]

ON JANUARY 18, 1971, BY JEROME

I have learned that sometime ago, FRANK YACOPEC and JERRY TARTAGLIO were in contact with a retired Army colonel who claimed he was some kind of an aide to General PATTON, or otherwise connected with him, when PATTON was involved in desert maneuvers and training in the Palm Springs, California, area at about the beginning of the second World War. According to what this colonel said, PATTON and his troops received urgent orders requiring them to pack up and ship out to go overseas with only two days notice. Because of such short notice, rather than taking their heavy equipment and supplies with them, they simply abandoned and buried them in wholesale quantities. I understand that many trucks and tanks were part in ravines and gullies and dirt was bulldozed over them. There are a lot of recorded instances where people have found such buried supplies in the desert out beyond Palm Springs. This area is still all Government property that is very little inhabited any any time. Apparently the Government has either lost its records, forgotten about, or simply doesn't care about all the stuff that is supposed to be buried out there.

In particular, this colonel told YACOPEC and TARTAGLIO about a large concrete bunker with big double steel doors which he said was filled with ammunitions and explosives and also buried. He apparently told TARTAGLIO and YACOPEC how to locate the bunker and I understand that they went out to the desert and after digging through about six feet of sand, actually found the steel doors to the bunker. Following this, they covered the bunker up again and have not been back since.

On the 27th of this month, a group including YACOPEC, BARRY GODFREY and PETER REPLINGER are going to go out to the desert to try and relocate the bunker and dig it out. I understand that REPLINGER has access to a portable jackhammer and some other heavy equipment which he will use to dig out the bunker.

If it is at all possible, I will try and go along with them to see what they actually find.

Jerome

Date prepared

1/29/71

Date received

1/25/71

Received from (name or symbol number)

SA 155-R

Received by

SA Steven L. Christensen

Method of delivery (check appropriate blocks)

in person by telephone by mail orally recording device written by Informant

If orally furnished and reduced to writing by Agent:

Date

Dictated _____ to _____

Transcribed _____

Authenticated by Informant _____

Date of Report

1/25/71

Date(s) of activity

1/24/71

Brief description of activity or material

Info re activities of MM at Casimiro Ranch

File where original is located if not attached

170-286A

* INDIVIDUALS DESIGNATED BY AN ASTERISK (*) ONLY ATTENDED A MEETING AND DID NOT ACTIVELY PARTICIPATE. VIOLENCE OR REVOLUTIONARY ACTIVITIES WERE NOT DISCUSSED.

Information recorded on a card index by _____ on date _____

Remarks:

157-1798 (MM)
~~170-286A-70~~
100-14610 (Stan McDade)
100-15355 (Jerry Busch)
100-14297 (Doris)
100-15356 (Geo. Hoover)
100- (Roger Willis) Prev. O pencil
100-14294 (Howard Clark)

Block Stamp

170-286A-70
SEARCHED INDEXED
SERIALIZED FILED
FEB 1 1971
FBI - SAN DIEGO
Christensen

ON JANUARY 25, 1971, BY JEROME

I was at the Gunsmoke Ranch in Harbison Canyon yesterday. When I got there, there were already 15 people present, most of whom I did not know and as I was leaving, three more people, STAN MC DADE and his two sons, arrived. Those I knew among the others present were JERRY BUSCH, SAM DAVIS, GEORGE HOOVER and ROGER WILLIS. Two of the others that I noticed in particular were a young fellow in his early 20's about 5' 6" tall, 130 pounds, dark brown hair, who was called GEORGE, and a big fellow with shoulder length hair and a goatee beard who was about 45 years old, 6' 5" tall, 300 pounds and bald. I believe he may have been referred to by the name ROYAL.

There did not seem to be any organized activity in progress. Most of the people were just more or less milling around and talking with each other. Most were carrying pistols and most were shooting muzzle loading weapons at one time or another.

While I was there, I got to talking to SAM DAVIS about HOWARD CLARK who lives at Ramona. DAVIS stated he felt he could trust CLARK completely and backed this up saying that CLARK is storing some weapons for him. DAVIS said he had also been working on some machine guns with CLARK at Ramona at one time and added ~~that CLARK can get all of the TNT and C-4 plastic explosives he~~ wants. DAVIS said he would get a list of prices of this stuff ~~from CLARK~~ on February 25, 1971, and added that he, DAVIS, has to go to court that morning to answer charges on three traffic warrants.

DAVIS also told me he will be going up to Mud River, Idaho, sometime in the early part of this summer with several other people to live. He said he will give me his address there when it becomes available to him as he wants to stay in touch with me. It appears this may be a Minutemen commune he has been talking about starting for several months now.

Davis

Date prepared

1/29/71

Date received

1/26/71

Received from (name or symbol number)

SD 1155-R

Received by

SA Steven H. Christen

Method of delivery (check appropriate blocks)

in person by telephone by mail orally recording device written by Informant

If orally furnished and reduced to writing by Agent:

Date

Dictated _____ to _____

Transcribed _____

Authenticated by Informant _____

Date of Report

1/26/71

Date(s) of activity

1/26/71

Brief description of activity or material

Info re possible BPP named Maury (LNU) + MM activities

File where original is located if not attached

170-286A

* INDIVIDUALS DESIGNATED BY AN ASTERISK (*) ONLY ATTENDED A MEETING AND DID NOT ACTIVELY PARTICIPATE. VIOLENCE OR REVOLUTIONARY ACTIVITIES WERE NOT DISCUSSED.

Information recorded on a card index by _____ on date _____

Remarks:

157-1798 (MM) Index: Bob Sisk
170-286A-71
100-14293 (Clay)
52-4723 (Albert McGill)
100-14297 (Davis)
157- (Maury (LNU) open and assign)

170-286A-71

SEARCHED	Block Stamp
SERIALIZED	FILED
FEB 1 1971	
FBI - SAN DIEGO	

[Handwritten signature]

ON JANUARY 26, 1971, BY JEROME

This morning I answered an ad in the newspaper and purchased a .22 calibre Remington rifle for \$20.00. I bought the gun from a Negro individual by the name of MAURY (ph) (LNU) who is presently residing at 5880 University, Apartment #9. He looked to me to be in his late 20's, about 5' 9" tall and slender and was wearing a goatee beard and a moustache. He wore his hair in a modified Afro style and resembled comedian BILL COSBY very much, both in physical appearance and mannerisms.

He told me he had just moved to San Diego from Los Angeles and is looking for work.

While I was at his apartment, I noticed he had large quantities of Black Panther and other black militant literature, including books by ELDRIDGE CLEAVER and copies of the Black Panther Party newspaper.

In addition to the .22 calibre rifle, he also had in his possession a .32 calibre automatic pistol which is a cheap imitation of the French MAB and is made in Spain.

It has been learned that there is a San Diego Police Department officer named BOB SISK who claims he is a member of the Minutemen organization.

I was in contact with GILBERT MC GILL Sunday. He is still employed at the Telephone Company. He told me he has been helping to tap some telephone lines and that it is still a common practice for Telephone Company employees to listen in on telephone conversations in the San Diego area.

Regarding the possibility of a big Minutemen meeting during the middle of December, 1970, I was unable to get in touch with BILL CLAY during almost the entire last half of December and it is possible he may have gone to the Chicago meeting. It is also possible that SAM DAVIS may have gone as I am frequently unable to contact him for several days at a time.

Jerome

Memorandum

TO : SAC, SAN DIEGO (170-286 A)

DATE: 2/12/71

FROM : SA STEVEN L. CHRISTENSEN

SUBJECT: *informant*
SD 1155-R

On 2/11/71, source observed a rally on the San Diego State College campus which began at 11:00 a.m., with a meeting on the library lawn. Following this, between 500 and 1,000 students marched across the campus chanting slogans against the current military operations in Laos.

Source said following the march the rally continued with a skit put on by a group known as the Chicano Guerilla Theatre. Following this a young male individuals named "SKIP" who said he was from MDM, spoke to the crowd urging them to harass the Marine Corps at Camp Pendleton, California, during the upcoming courts martial of two MDM members there.

Following this a young girl got up and announced there would be a meeting Sunday evening, 2/14/71, to plan for a big rally on San Diego State College campus Wednesday, 2/17/71. She indicated that persons desiring to attend the meeting should gather "down by the trees" and from there they would march to the meeting place.

She further stated that an additional purpose of the meeting would be to organize a new radical group on the San Diego State College campus which would cover all issues rather than having several organizations each interested in only one specific issue.

1 - 170-286 A
 1 - 100-14528 (STAG)
 1 - 100-14892 (MDM)
 1 - 25- (HARASSMENT OF LOCAL
 SELECTIVE SERVICE SYSTEM 2/16/71 - 2/19/71)
 1 - 100-13847 (SMC)
 1 - 62-2008 (COM)
 1 - 100-14495 (STANCLIFF)
 1 - 100-15337 (STARSKEY)
 1 - 100- (HARRY RUJA)
 1 - 100-14733 (GULLEY)
 1 - 100-14646 (STANCLIFF)
 1 - 100-15507 (STEVE NYSTROM)
 1 - 100-14720 (WOMENS LIB)

SLC/gak
 (13) *gak*

170-286A-72

SEARCHED	INDEXED
SERIALIZED	FILED
FEB 16 1971	
FBI - SAN DIEGO	

Buy U.S. Savings Bonds Regularly on the Payroll Savings Plan



SD 170-286 A

Source also learned there was to be a closed meeting at 3:00 p.m., on 2/11/71, to plan for the Sunday evening meeting.

Following this the microphone was opened to the audience but only one individual, a young male individual with long hair and wearing no shirt or shoes, took advantage of the opportunity. He spoke against carrying the Viet Cong flag and against trying to destroy the system saying he believed the necessary changes could be made within the established frame work. He was not too well received.

Source also acquired a leaflet distributed by members of the Student Mobilization Committee (SMC) at the University of California at San Diego (UCSD). The leaflet called for a massive demonstration against the local draft board office on Park Boulevard and starting with a "mass-in" at the local board building at 10:00 a.m., on 2/16/71.

The leaflet indicated that persons interested in participating should assemble in the Urey Hall parking lot at UCSD at 9:15 a.m., on 2/16/71. Other persons desiring to attend should find their own transportation. For further information interested persons were requested to call telephone number 453-3362.

The leaflet stated that SMC desired to obtain the signatures of enough people so that during the period 2/16/71 - 2/19/71, 20 persons per hour could be assigned to be present at the draft board for harassment purposes.

The leaflet indicated that there are many legal forms of harassment which should be engaged in such as bringing any kind of garbage or miscellaneous articles to be filed in a registrant's folder as Selective Service law states that a registrant may place anything in his folder which he feels is pertinent to his draft status.

SD 170-286-A

The leaflet urged registrants to appear at the draft board simply to examine their file, or to ask any of a number of questions regarding their draft status, or the Selective Service System itself.

The leaflet urged females to appear at the draft board and demand to be allowed to register for the draft denouncing the Selective Service System as sexist and racist or to flood the place with tears asking that their boy friends, brothers, etc., be exempted from the draft.

The leaflet also urged interested persons to deluge the draft board with letters requiring file searches and return correspondence in an effort to tie up the system. It pointed out that females by using their first initial and last name could request information from their non-existent files without being traced.

In addition, the leaflet urged persons to tie up the draft board telephone lines with many miscellaneous telephone calls.

Also obtained was a leaflet requesting help and support in the case of SAMUEL C. MILLER, a prisoner in the brig at the 32nd Street Naval Station. The leaflet was issued by Concerned Officers Movement and indicated the group has a house at 3788 Tenth Street, San Diego, California, telephone number 291-4062.

Source also obtained a leaflet indicating there will be some kind of a "teach-in" on the war in Southeast Asia with news film clips and other material at San Diego State College on 2/11/71 and 2/16/71, at 7:00 p.m.

SD 170-286 A

Source recognized the following persons present at the rally:

ALAN STANCLIFF

MORRIS STARSKEY (possibly)
(Source noted STARSKEY has a new office in the East Wing of the new library Room 529, telephone 286-5549)

HARRY RUJA

GARY GULLEY

CONNIE STANCLIFF

B. J. BYSTROM

A girl named "PAT" from Womens Liberation

new

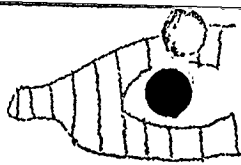

CONSCRIPTION (the latest

fad sweeping America
Colleges and U's.)

In response to the escalation of the war into Laos the UCSD Student Mobilization Committee is planning a non-violent disruption of the San Diego Draft Board for the entire week of Feb. 16-19 (Tuesday to Friday). This action will be legal but effectively limit business as usual. Suddenly the draft board will be invaded by hundreds of people, gravely concerned about their draft status or the draft status of their loved ones. Some of the methods we suggest are:

1. Ask to see your files.
2. Ask to make appointments to see your files.
3. Bring in anything you feel is pertinent to your case. This might include such things as a statement of your feelings about the war, a roll of toilet paper, a dead fish, a marble. The board is required to accept and file all data you feel is pertinent to your draft status.
4. Women can do several things; they can insist they want to register, for example, proclaiming the army a sexist institution or they can tearfully ask the board to spare their boyfriends.

We will make use of the draft board's bureaucracy to shut it down. This method has been tried successfully in New York and several other Eastern cities.

TUESDAY FEBRUARY 16 MASS AT THE DRAFT BOARD AT 10:30. The address is 3757 Park Boulevard - 1/2 block south of the Capri Theater at Park and University. Wednesday through Friday the action will continue and UCSD SMC is planning to have atleast 20 people per hour at the draft board. UCSD volunteers should sign up for hours on these three days at the table on Revelle Plaza to ensure effectiveness. Students from other campuses should come whenever they have available time; EVERYONE SHOULD BE THERE TUESDAY.

If you are not able to come, there are other ways of interfering with the draft board. Take a 6¢ stamp, put it in an envelope addressed to the Selective Service System (preferably without your name) say hello, send coupons, send more toilet paper. Better yet, if you're a woman, write a letter asking for information about your file and sign this with your first initial only and last name (e.g. T. Nixon). You cannot be traced, you will cause at least minimum interruption as they search for your file. Most important: if you have a dime call the draft board next week at 293-5180 and talk about anything you want (Is this the zoo? Is my money here?) Call a lot. Tie the phones up next week while we tie the office up. Enjoy yourself, be creative!

People from UCSD going to the Tuesday action should assemble at 9:15 in the Urey Hall Parking lot. Bring a car if you can. Anyone who can offer transportation to the draft board during the rest of the week please sign up at the table in Revelle and we will refer riders to you.

For any questions or information that would be helpful to us please call 453-3362 (UCSD Information Center). Remember: TUESDAY FEBRUARY 16 AT THE DRAFT BOARD. BEING A FRIEND.

each-in On the War

ATTEND THE FAR OUT FREE FLICKS

ON DICK'S WAR, HERE AND THERE!

NEWSREEL FILM PRODUCTIONS PRESENTS:

AmeriKa: Chicago, 1968; Stop the Draft Week; and the Black Lib. Struggle.

People's War: The latest, most comprehensive documentary of the Vietnamese People's daily struggle.

ALSO SPEAKERS AND DISCUSSIONS

Thursday February 11, 7:00 P.M. SSI00

Tuesday February 12, 7:00 P.M. SSI00

The United States is escalating the war in South East Asia. Troops have moved into Laos and Cambodia, the bombing increases, and U.S. commandos attack inside North Vietnam. The administration's long term plans call for replacing U.S. soldiers with mercenaries, and automating the war with more planes, bombs, and perhaps even "tactical" nuclear weapons. Through all this the people of Cambodia, Laos, and Vietnam hold firm, continuing to fight courageously against U.S. domination.

At home, we are beginning to realize that a government guilty of GENOCIDE and ECOIDE in South East Asia cannot permit "liberty and justice for all".

The people of Indochina need our continuing support. By getting our schools and our communities together, we can best aid their liberation and our own.

More War

+

No Classes

FOR WOMEN'S CONFERENCE

FEBRUARY 12 & 13
AT THE YWCA 1012 C STREET, SAN DIEGO

The first women's conference in San Diego will bring together women interested in sharing ideas concerning our secondary position in society, and in formulating actions and organization to change this. A proposal for the establishment of a San Diego Women's Center, as one step in this direction, will be discussed.

All women are invited to attend and participate. Child care, housing and transportation will be provided.

SCHEDULE

FRIDAY, FEB. 12

- 9---Introduction
- 10---"What is Women's Liberation"
- 12---Lunch, bring your own
- 1---Margaret Wright, speaker on "Sexism and Racism"
- 2---Film, discussion groups
- 3:30---Break
- 4---Workshops I
- 6---Dinner, pot luck, bring a dish!
- 7:30
- 9---Workshops II

SATURDAY, FEB. 13

- 10---Women's Center, discussion on proposals
- 12---Lunch, bring your own
- 1---Wrap up, on Women's Center and proposals from workshops
- 3---Plans for action, e.g. International Women's Day
- 6---Dinner, Celebration, film, music, a time to relax!

WORKSHOPS

The workshops will deal with WOMEN and their relation to child care, abortion, work, the war, history, psychology, welfare, marriage and the family, rap groups, politics and as Woman identified Woman, Black and Brown Women, High School Women, and consumers.

For further information or transportation call: 286-6524 or 286-6509. If you plan to use child care facilities at conference, please call 453-1518.

BY STEP, LIE BY LIE
THE NEW
ESCALATION



HANDS OFF LAOS!

The government has been telling you the troops are coming home and its a lie. They are escalating and the news is so bad that nothing is being released. The people of Laos are suffering: 800 raids by plane per day - Laos is the most bombed country in the world! - one fourth of the population are refugees from American bombing.

Our campus is directly supporting the war via: ROTC - NEL - the recruitment of students on campus by corporations that profit and survive on the war.

In view of this crisis, let us unite in a peaceful, legal, protest.

MASSIVE DEMONSTRATION AND RALLY

THURSDAY 11:00

Rally on Old Library Lawn 11:00

March across campus 11:30

Rally in Aztec Center 12:00

OUR SISTERS AND BROTHERS IN S.E. ASIA ARE COUNTING ON US. WE MUST ACT NOW!

U.S. OUT OF ASIA

EVER
Amuel C. Miller is a prisoner in the 32nd Street BRIG.

- Sam Miller is a conscientious objector.
- Sam Miller has written: By lending my support to the military, I also become responsible to God for those major actions of the military. Therefore I have been forced to accept the responsibility of war and death. This responsibility I can no longer accept. A Christian citizen must be responsible to both man and God, what he may not do is obey men rather than God, or overlook the degree of compromise in our best acts, or gloss over the sinfulness of war.
- A Navy Chaplain writes: Sam Miller is a sincere, devout Christian. He is regular in his attendance of Divine Worship and gives every expression of following the teachings of Christ.

His minister writes: His beliefs are well grounded in the church and Bible and his actions have been true to his beliefs. I have no hesitation in submitting this letter declaring the credibility of Mr. Miller's decision for release from military involvement due to religious beliefs.

The Navy Times, Jan 20, 71: Military officers have a hard time being judicial about these claims, ... because "the notion is widely held that conscientious objectors are at best cowardly and at worst subversives."

Department of Defense Directive 1300.6 (VI. A.1) Employ the person (conscientious objector) in duties which involve the minimum practicable conflict with his asserted beliefs pending investigation and decision on the case.

THIS CASE HAS NOT EVEN BEEN DECIDED UPON BY THE NAVY

Under orders to Southeast Asia for the second time, Sam Miller wrote, "Such participation in this ship's movement would be in direct conflict with my asserted beliefs."

SAM MILLER did the only thing he could do in conscience, he refused to go. He never went UA. He was convicted before a General Court Martial of Missing Movement. Results;

1. Nine months confinement at hard labor. (8 mos to 10)
2. Total forfeiture of pay.
3. Reduction in rate from E-5 to E-1.
4. A Bad Conduct Discharge from the Service.

THE NAVY HAS STILL NOT PASSED JUDGMENT ON HIS CONSCIENTIOUS OBJECTOR CLAIM (as of 10 February 1971)

OVER

OVER

OVER

OVER

SAC, SAN DIEGO (157-28)

2/12/71

SA STEVEN L. CHRISTENSEN

NATIONAL SOCIALIST WHITE PEOPLE'S PARTY
RACIAL MATTER

CONF SOURCE

On 2/4/71, ED DANNER, Investigator, San Diego County District Attorney's Office, made available the attached information regarding activities of captioned organization.

It is noted that the attached material indicates that MATT COLE or KAHLE, National Commander of captioned organization, is expected to be in the San Diego, California area on 2/14/71, for the purpose of recruiting and organizing for his organization at San Diego.

On 2/11/71, ^{Informant} SD/1155-R was contacted regarding the attached material and advised he is unfamiliar with any of the individuals involved but stated if COLE does come to the San Diego area, he will in all likelihood contact VIC WALTON or JOE BRINKER.

Informant stated that VIC WALTON has fallen into disfavor with many local right wing individuals as he has apparently sold some of them down the river in court cases. He said there has even been some talk about killing WALTON.

- 2 - 157-28
- ① - 170-286 A
- 1 - 100-14303 (VIC WALTON)
- 1 - 100-14292 (JOE BRINKER)

SLC/gak
(5) *gak*

170-286-A-73

SEARCHED	INDEXED
SERIALIZED	FILED
FEB 16 1971	
FBI - SAN DIEGO	

Date prepared

2/24/71

Date received

2/4/71

Received from (name) or symbol number

SD 1155-R

Received by

SA Steven L. Christensen

Method of delivery (check appropriate blocks)

in person by telephone by mail orally recording device written by Informant

If orally furnished and reduced to writing by Agent:

Date

Dictated

2/19/71 to G. Kamery

Transcribed

2/23/71

Authenticated by Informant

2/24/71

Date of Report

2/24/71

Date(s) of activity

2/4/71

Brief description of activity or material

Note received at MM POB - Activities of Davis, Forrest, Hoover, Willis -

File where original is located if not attached

* INDIVIDUALS DESIGNATED BY AN ASTERISK (*) ONLY ATTENDED A MEETING AND DID NOT ACTIVELY PARTICIPATE. VIOLENCE OR REVOLUTIONARY ACTIVITIES WERE NOT DISCUSSED.

Information recorded on a card index by _____ on date _____

Remarks:

- 157-1798 (MM)
- 170-286A-74
- 157-2224 (Isaac Cantrell)
- 157-2178 (Dominic)
- 157-2177 (Tom Forrest)
- 100-4297 (Davis)
- 100-15356 (Hoover)
- 100-15666 (Roger Willis)

170-286A-74
Block Stamp

SEARCHED	INDEXED
SERIALIZED	FILED
FEB 26 1971	
FBI - SAN DIEGO	

On February 4, 1971
By JEROME

Today I checked the Minutemen Post Office Box at Spring Valley, California, and found a letter addressed to AFSC. The person sending the letter used regular Minutemen precautions in sending it, such as double wrapping the message.

The message itself was written on a two inch by four inch piece of paper in grease pencil and said, "Make contact February 7, 7:00 a.m., 445-9570". This looks very interesting and I plan to go ahead and make the contact as requested on the note.

I have learned recently that SAM DAVIS and TOM FORREST have been doing a lot of business together for some time. The name RONALD TIMOTHY DOMENICK or DOMINIC is not familiar to me but the name "PAUL" and the description you gave me sounds like an individual who hangs around with FORREST and some of the other gun people.

I also have heard a rumor before that FORREST is operating some kind of a shop on the Mexican boarder and FORREST allegedly deals in a lot of illegal stuff.

FORREST has had two large boats and lost both of them. There is a story around which I believe is probably true that his second boat was bombed as a result of a quarrel or something over smuggling. I have never heard anything about him having any hand grenades on the boat but he may have had some kind of high explosives on it.

With regard to the Gun^oSmoke Ranch being for sale, it is my understanding that all of the people at the ranch including DAVIS, HOOVER, WILLIS and several others will eventually be going to the Mud River, Idaho, area.

Jerome

On February 4, 1971
By JEROME

2/4/71

Note:

On February 5, 1971, it was determined that telephone number 445-9570 is a public pay telephone located in the front of a liquor and grocery store at 2262 Highway 80 by Alpine, California. The location of this telephone number was furnished to informant so that he might have it watched in an effort to determine the individual's identity he would be contacting.

Jerome

Date prepared
2/24/71

Date received
2/8/71

Received from (Name or symbol number)
SD 1155-R

Received by
SA Steven L. Christensen

Method of delivery (check appropriate blocks)

in person by telephone by mail orally recording device written by Informant

If orally furnished and reduced to writing by Agent:

Dictated 2/19/71 to J. Ramsey

Transcribed 2/23/71

Authenticated by Informant 2/24/71

Date of Report
2/8/71

Date(s) of activity
2/9/71

Brief description of activity or material
Contact w/ Isaac Cantrell, Sam Davis. Paul Hunt at L.A.

File where original is located if not attached

* INDIVIDUALS DESIGNATED BY AN ASTERISK (*) ONLY ATTENDED A MEETING AND DID NOT ACTIVELY PARTICIPATE. VIOLENCE OR REVOLUTIONARY ACTIVITIES WERE NOT DISCUSSED.

Information recorded on a card index by _____ on date _____

Remarks:

- 157-1798 (MM)
- 170-286A-157
- 157-2224 (Cantrell)
- 157-1815
- 100-74016 (Houghton)
- 100-157-1820 (Yacopce)
- 100-14297 (Davis)
- 100-14015 (Houghton)
- 100-14293 (Clay)
- 100-157-2177 (Forrest)
- 3- Los Angeles
 - (1- Paul Hunt)
 - (1- Dennis Mower)

Index: Paul Hunt,
157-242 Dennis Mower

17 (Black Stamp) 157-286A-75

SEARCHED	INDEXED
SERIALIZED	FILED
FEB 26 1971	
FBI - SAN DIEGO	

[Handwritten signature]

On February 8, 1971
By JEROME

Yesterday at 7:00 a.m., I contacted the individual who sent the note in the mail as he had requested. We made arrangements to meet together at the Denny's Restaurant in El Cajon. I plan to have SAM DAVIS or GEORGE HOOVER or both there to watch the meeting and make sure nothing funny happens.

The person I talked to on the telephone gave me what he said was his Minuteman Serial Number. I subsequently checked this number with BETTIE HOUGHTON who said the number is a good one and falls within a block of numbers which she said she knows was legitimately issued. She said she has access to some files which may include this number so that possibly she can find out who the person is.

While I was making the call I had FRANK YACOPEC watching the telephone booth up at Alpine. FRANK pretended to have a flat tire by stopping about a half a mile down the road from the telephone booth where he let some air out of one of his tires. He then drove his car to an air pump at a service station near the telephone booth where he was able to watch the person who received the call. After the call was over he followed this individual to a side street named Marshall Road. When he got to the road and looked the person had disappeared. He said there were only two cars on the road which looked like they had been driven recently which had the following license plate numbers:

WAB 703

and

YCB 714

I also had a long talk with SAM DAVIS today and obtained the following information:

Jerome

On February 8, 1971
By JEROME

He said that one PAUL HUNT at Santa Monica, California, is the person who is actually in charge of the Minutemen in the State of California or at least in that area and he has been so in charge since the disappearance of TROY HOUGHTON. He added that DENNIS MOWER is only a public figurehead and added that he thinks PAUL HUNT is a very dangerous man.

On the subject of TROY HOUGHTON, I have learned from both DAVIS and BILL CLAY that HOUGHTON's contacts may have been much more widely spread than I thought. Specifically, they told me that HOUGHTON was behind an attempt several years ago by 18 "hunters" in the State of New York to conduct sabotage and terrorist attacks on New Left Groups. These 18 individuals were supposedly arrested and a large quantity of weapons and ammunition was confiscated.

I also talked some more with DAVIS about TOM FORREST and it appears that they know each other extremely well. DAVIS said he had some business dealings with FORREST involving some machine guns and other items.

DAVIS apparently has decided not to get rid of as much of his explosives and so forth as he originally said. He has a small quantity of T.N.T. and also some C4 Plastic explosives which he will sell at \$10 a pound which is too high a price.

He said he can also obtain a military weapon which is like a bazooka and has a self-contained 3.5" rocket round in an expendable launcher. He said the price of this is \$25.

Jerome

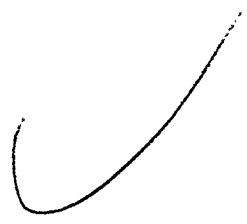

SSC Request 1/20/76
Item 3 (Re: Secret Army Organization)
Volume II

Access

UNITED STATES GOVERNMENT

Memorandum

TO : ACTING DIRECTOR, FBI(157-23577) DATE: 11/10/72

FROM : SAC, SAN DIEGO (157-3388) (C)

SUBJECT: VAHL ALDERMAN BOYLE, aka
Minnie Vahl Isobel Alderman,
Minnie Vahl Boyle,
Mrs. Theodore J. Boyle,
Val Boyle,
Vahl Boyles,
Val Boyles,
Minnie Vahl Isobel Haughton,
Minnie Vahl Isobel Houghton
EM - SAO
(OO: San Diego)

Enclosed for the Bureau are five copies of an LHM regarding subject. Original and one copy of form FD-376 stapled to this LHM.

Local dissemination of LHM being made to U. S. Secret Service, San Diego.

All investigation contained in this LHM was conducted by SA DWIGHT G. GARRETSON with the exception of credit and arrest checks which were conducted by IC JOHN R. BAKER.

NCIC was negative on 6.5 mm rifle, serial number AZ2458.

Subject's activities do not warrant her inclusion in ADEX.

San Diego contemplates no additional contact with subject.

REC-89 157-23577-70

11-10-72

21 NOV 17 1972

2 - Bureau (Enc. 5) (RM)
1 - San Diego

DGG/rss
(3)

ENCLOSURE

1 CC SS w/photo
1 CC ISD
1 CC ORL

PLS
11/28/72

CAM/mfm

EXT. INT. SEC.



NOV 28 1972

Buy U.S. Savings Bonds Regularly on the Payroll Savings Plan



UNITED STATES DEPARTMENT OF JUSTICE
 FEDERAL BUREAU OF INVESTIGATION
 San Diego, California
 WASHINGTON, D.C. 20535
 November 10, 1972

In Reply, Please Refer to
 File No.

Director
 United States Secret Service
 Department of the Treasury
 Washington, D. C. 20220

RE: VAHL ALDERMAN BOYLE

Dear Sir:

The information furnished herewith concerns an individual or organization believed to be covered by the agreement between the FBI and Secret Service concerning protective responsibilities, and to fall within the category or categories checked.

1. Threats or actions against persons protected by Secret Service.
2. Attempts or threats to redress grievances.
3. Threatening or abusive statement about U. S. or foreign official.
4. Participation in civil disturbances, anti-U. S. demonstrations or hostile incidents against foreign diplomatic establishments.
5. Illegal bombing, bomb-making or other terrorist activity.
6. Defector from U. S. or indicates desire to defect.
7. Potentially dangerous because of background, emotional instability or activity in groups engaged in activities inimical to U. S.

Photograph has been furnished enclosed is not available.

Very truly yours,

L. Patrick Gray, III
 Acting Director

1 - Special Agent in Charge (Enclosure(s)) (1)
 U. S. Secret Service , San Diego

Enclosure(s)



UNITED STATES DEPARTMENT OF JUSTICE

FEDERAL BUREAU OF INVESTIGATION

San Diego, California

In Reply, Please Refer to
File No.

November 10, 1972

VAHL ALDERMAN BOYLE

On March 13, 1972, Howard Barry Godfrey advised that on March 12, 1972, Bettie Ellen Haughton, wife of Troy Harold Haughton, former local leader of the Minutemen in San Diego, California who disappeared in 1967, said that a large quantity of explosives were reported to be buried under the house of Vahl Boyle, Troy Haughton's mother. ✓

Howard Barry Godfrey, for a number of years, voluntarily furnished information to the Federal Bureau of Investigation regarding the identities and activities of extremist groups in the San Diego area. His information has been reliable and as an interested citizen he volunteered his knowledge and services to local law enforcement agencies which culminated in his appearances and testimony for the San Diego Grand Jury in June and July, 1972.

The Minutemen is a paramilitary group organized in June, 1960, by Robert B. DePugh in Norborne, Missouri, as a resistance to the spread of communism in the United States by use of guerrilla tactics. DePugh is currently incarcerated in a Federal penitentiary for violation of the Federal Firearms Act.

The Patriotic Party has been the political arm of the Minutemen.

This document contains neither recommendations nor conclusions of the FBI. It is the property of the FBI and is loaned to your agency; it and its contents are not to be distributed outside your agency nor duplicated within your agency.

157-23577-70

ENCLOSURE

VAHL ALDERMAN BOYLE

The July 25, 1972, issue of the San Diego Union, a daily newspaper, contained an article regarding a probe of the Secret Army Organization (SAO) by the San Diego Police Department. A portion of this article reported that on July 21, 1972, San Diego police had searched the residence of Mrs. Vahl Boyles, 4443 Upland Street, La Mesa, California. Officers reportedly found a quantity of drugs and medical supplies, explosive paraphernalia and Minutemen literature buried under the house. No arrests were made.

The SAO is an anticommunist, paramilitary organization formed in 1971 in San Diego, California. It intends to conduct intelligence-type operations and to offer training in urban guerrilla warfare to be used against "left-wing groups" and suspected enemies of the United States.

On August 22, 1972, it was determined through California Law Enforcement Telecommunications System (CLETS) that Vahl Alderman Boyle, 4443 Upland Street, La Mesa, California, has California Driver's License F0435561.

On August 11, 1972, and again on September 21, 1972, records of the San Diego Police Department and the San Diego County Sheriff's Office contained no arrest record for the subject.

On September 28, 1972, the FBI Identification Division advised that no record for the subject could be located by that Division.

On August 17, 1972, records of the Merchants Credit Association, San Diego, disclosed that subject was married to Theodore J. Boyle, and had formerly resided at 3865 Caranaha Street, Lemon Grove, and 8038 Nazer Street, Lemon Grove, California. Her employment was shown as real estate sales and employment for Theodore J. Boyle shown as Vice President of Business Forms.

On September 21, 1972, Sergeant Jack R. Pearson, Investigative Support Unit, San Diego Police Department,

VAHL ALDERMAN BOYLE

advised that subject's residence had been searched on July 21, 1972, pursuant to a search warrant based on information furnished by Howard Barry Godfrey. The search resulted in the discovery of the following items:

1. Training Charts (30 caliber M-1)
2. Aerial Sectional Charts
3. Charts of Grenade Launchers
4. One military can containing crimping tools, electric blasting caps, non-electric blasing caps, fuse ignitors, and safety fuse
5. Two military ammo cans containing medical supplies (Hype Kit - miscellaneous drugs)
6. One 22 caliber rifle "Explorer AR-7"
7. One 6.5 caliber rifle "AZ 2458"
8. Three boxes of 7.62 mm ammo
9. One box of 6.5 mm ammo
10. Six boxes of 22 caliber ammo
11. Two 22 caliber clips

Sergeant Pearson advised that subject had stated that the last six items were her personal property and she exhibited receipts for these items. Subject had not been arrested by the San Diego Police Department.

On September 22, 1972, Detective Nancy Bird, Office of Special Investigation, San Diego County Sheriff's Office, advised that San Diego Sheriff's Office had participated in search of subject's residence and further advised that subject

VAHL ALDERMAN BOYLE

had not been arrested by San Diego Sheriff's Office.

During October, 1972, several attempts to contact subject at 4443 Upland Street, La Mesa, California, were unsuccessful as no one was home.

On October 29, 1972, subject was telephonically contacted at her residence telephone 469-1129. She advised that she had just returned from vacation and that her personal affairs would prevent her from being available for interview prior to Wednesday, November 8, 1972.

The following is a composite description of the subject as obtained from sources previously mentioned herein:

Name	Vahl Alderman Boyle
Aliases	Minnie Vahl Isobel Alderman, Minnie Vahl Boyle, Mrs. Theodore J. Boyle, Val Boyle, Vahl Boyles, Val Boyles, Minnie Vahl Isobel Haughton, Minnie Vahl Isobel Houghton
Race	White
Sex	Female
Date of birth	March 11, 1914
Place of birth	Granger, Idaho
Height	5'2"
Weight	127 pounds
Eyes	Brown
Hair	Blonde

FEDERAL BUREAU OF INVESTIGATION

Date of transcription November 10, 1972

Mrs. VAHL ALDERMAN BOYLE, 4443 Upland Street, La Mesa, California, was telephonically contacted at her residence telephone 469-1129, with the intention of making appointment for interview. Mrs. BOYLE stated that her personal affairs were keeping her busy and she did not know when she would be available for interview. She further advised that she did not desire to be interviewed by two Agents of the FBI as she became nervous under these circumstances. She said she would prefer to be interviewed by a lone Agent, reserving the right to have a witness of her own present during the interview. She added that she would be glad to answer any questions over the telephone.

When questioned regarding material found at her residence during a search conducted by the San Diego Police Department Mrs. BOYLES stated that most of the material located by the Police Department had been the property of her son, Troy Harold Haughton, which material had been left there by him prior to his disappearance in 1967. She continued that charts, signs, maps, medical supplies and blasting materials had been the property of TROY. She said that two rifles and a quantity of ammunition taken by the Police Department had been her personal property for which she had receipts and which had subsequently been returned to her by the Police Department.

Mrs. BOYLE continued that she was well aware that her son TROY had been a leader of the Minutemen Organization in San Diego, but said that she herself was not very familiar with this organization. She said that the last contact she had had with TROY had been a telephone call during approximately April, 1967, while she had been in Europe on a vacation. At that time TROY had told her that he was going to get out of the Minutemen organization and had told her that he was worried about what the Minutemen leaders would do when he told them he wanted to leave the organization.

- 5 -

Interviewed on 11/8/72 at San Diego, California File # SD 157-3388

by DWIGHT G. GARRETSON/rss Date dictated 11/9/72

This document contains neither recommendations nor conclusions of the FBI. It is the property of the FBI and is loaned to your agency; it and its contents are not to be distributed outside your agency.

SD 157-3388

She commented that she firmly believes that TROY was murdered by ROBERT DE PUGH, WALTER PEYSON and LESTER MOLYNEAUX. She said she had never met any of these three individuals but bases her belief on what TROY told her in the above mentioned telephone call and upon information furnished to her by TROY's wife BETTIE ELLEN Haughton CALIF.

CALIF.
MRS TROY Harold Haughton
Mrs. BOYLE advised that BETTIE HAUGHTON recently obtained a divorce from TROY in order that she might remarry, inasmuch as she had been unable to prove that TROY was dead. She did not know where this divorce action occurred except that it was not in San Diego County. Mrs. BOYLE advised that she knew nothing whatsoever about the Secret Army Organization (SAO) and had never heard of this organization until the arrest of some of its members appeared in the newspapers in June, 1972. MEMBER of

She said she was acquainted with JERRY LYNN DAVIS, aka the alleged leader of SAO, whom she knew as SAM DAVIS. She said that she had met GEORGE MITCHELL HOOVER, another alleged member of the SAO who had been arrested, but was not really acquainted with him, knowing only that he was an associate of DAVIS. She remarked that the other persons arrested during the SAO investigation were not known to her. CALIF.

SECRET ARMY ORGANIZATION
Mrs. BOYLE commented that she did not approve of the actions of SAO and further that she had not approved of the actions of the Minutemen Organization, although her son TROY had been a leader in the group.

VAHL ALDERSON BOYLE

Robert DePugh and Walter Peyson were identified by Howard Barry Godfrey as former national leaders of the Minutemen organization.

Lester Molyneaux was identified by Howard Barry Godfrey as formerly active in Minutemen affairs.

Jerry Lynn Davis was identified by Howard Garry Godfrey as the leader of SAO. He was arrested on July 2, 1972, by San Diego Police Department for possession of explosives and receiving stolen property.

George M. Hoover was identified by Howard Barry Godfrey as a member of SAO. He was arrested on June 26, 1972, by San Diego Police Department for attempted murder.

F B I

Date: 11/11/72

Transmit the following in _____
(Type in plaintext or code)

Via A I R T E L A I R M A I L
(Priority)

TO: ACTING DIRECTOR, FBI (157-23577)

FROM: SAC, SAN DIEGO (157-2815) (P)

SECRET ARMY ORGANIZATION (SAO)
EXTREMIST MATTERS

*9/11/72
ICP*

Re San Diego teletype 10/25/72.

On 11/3/72, WILLIAM FRANCIS YAKOPEC entered a plea of guilty to a lesser charge of Possession of Inflammable Material with Intent to Burn, before San Diego County Superior Court Judge GILBERT HARELSON. He was sentenced to one to five years in the state prison to run concurrently with a one year to life sentence for bombing the Guild Theater in San Diego. The original charge was Possession of Explosives.

DEBORAH YAKOPEC, wife of WILLIAM FRANCIS YAKOPEC, was also charged with Possession of Explosives. She was allowed to plead guilty to a lesser charge of Disturbing the Peace and was fined \$20 by Judge HARELSON.

60

69

- 2 - Bureau (AM) (RM)
- 5 - San Diego
 - (2 - 157-2815)
 - (1 - 157-1820)
 - (1 - 157-3399)
 - (1 - 157-3017)

REC-5
ST-409

EMP:tld
(7)

3 NOV 15 1972

Deleted Copy Sent *Doug/ez Porter*
by Letter *9/11/72* p.1
for FCIA Request *0/5*

NOV 21 1972
F-395

EXH. 101
W.A.P.
P.W.P.

Approved: *RJS/34* Sent _____ M Per _____

SD 157-2815

The trial of ~~GEORGE MITCHELL HOOVER~~ is presently under way and former SA STEVEN L. CHRISTENSEN, EARL M. PETERSEN and HOWARD BARRY GODFREY, formerly SD 1155-E, will testify during week of 11/13-17/72. SA PETERSEN and former SA CHRISTENSEN will meet with AUSA SHELDON DEUTSCH at 9:00 AM, 11/13/72, regarding this testimony. AUSA DEUTSCH will be present as representative of the Justice Department at the trial.

SA EARL M. PETERSEN was advised on 11/10/72 that the trial of JERRY LYNN DAVIS, SAO leader, has been postponed and a new subpoena will be issued for SA PETERSEN's testimony.

F B I

Date: 11/3/72

Transmit the following in _____
(Type in plaintext or code)

GCM/R

Via AIRTEL AIRMAIL
(Priority)

TO: ACTING DIRECTOR, FBI (157-23577)
ATTENTION: DID

FROM: SAC, SAN DIEGO (157-2815) (P)

[Handwritten signature]

SECRET ARMY ORGANIZATION
EM

CALIF

On 11/2/72, SA EARL M. PETERSEN testified in a pre-trial hearing in the GEORGE MITCHELL HOOVER case in the Superior Court of the County of San Diego, without incident. AUSA JOHN R. NEECE was present during SA PETERSEN's testimony.

This pre-trial hearing was an attempt to suppress evidence obtained after serving of search warrant based on information relayed to the San Diego Police Department, by SA PETERSEN, by attacking the credibility of former FBI Informant HOWARD BARRY GODFREY. Superior Court Judge GILBERT HARELSON denied the motion to suppress the evidence and set a 11/8/72 trial date for HOOVER. *CALIF*

On 11/2/72 HOWARD F. CLARK, arrested and charged with possession of a tear gas gun, explosives and tracer ammunition, entered a plea of guilty before Superior Court Judge ROBERT W. CONYERS, San Diego County Superior Court on the charge of possession illegal tracer ammunition. Charges of possession of a tear gas gun and explosives were dropped. CLARK is scheduled for sentencing on 11/29/72. A maximum sentence of \$1000.00 fine and no time in custody was agreed to by the court.

- 2 - Bureau (RM)
- 4 - San Diego (2 - 157-3017)
- (2 - 157-2546)

EMP:ejt
(6)

REC-107

157-23577-68

Deleted Copy Sent Douglas Porter
by Letter 9/4/75
Per FOIA Request etc

23 NOV 7 1972

Approved: _____
Special Agent in Charge

Sent _____ M

Per _____ INT. SEC.

Domestic Intelligence Division

INFORMATIVE NOTE

Date October 26, 1972

Attached indicates an anonymous caller to Presidential candidate McGovern's Headquarters, El Cajon, California, alleged an FBI informant connected with the White Extremist Secret Army Organization offered explosives to him to use to bomb that Headquarters and when he refused, his Hertz Rental franchise was bombed.

Anonymous caller, apparently one Calvin Hendell Fox, a Secret Army Organization member recently indicted for perjury in connection with his testimony during trial in Superior Court, San Diego, California, of another Secret Army Organization member, William Francis Yakopec. This appears to be an attempt to discredit former Bureau informant Howard Barry Godfrey, whose testimony was instrumental in conviction of Yakopec.

Godfrey currently in Sacramento and is to be interviewed regarding allegation. Secret Service in San Diego cognizant.

WCP:vgc/mcl
w8

ESM
rw
Q WGC
CCM
ALD
10/27
10:29A
7

*Godfrey interviewed 10/26/72, denied allegation regarding offering explosives to blow up above headquarters.

FEDERAL BUREAU OF INVESTIGATION
COMMUNICATIONS SECTION

NR 02 SD CODE

2:55 PM URGENT 10-26-72 JBE

OCT 26 1972

TELETYPE

TO: ACTING DIRECTOR
(ATTN: DID) (157-23577)
SACRAMENTO

FROM: SAN DIEGO (157-2815) 5 P

Mr. Tolt	<input checked="" type="checkbox"/>
Mr. Baker	<input checked="" type="checkbox"/>
Mr. Bates	<input checked="" type="checkbox"/>
Mr. Bishop	<input type="checkbox"/>
Mr. Callahan	<input type="checkbox"/>
Mr. Cleveland	<input type="checkbox"/>
Mr. Conrad	<input type="checkbox"/>
Mr. Daiter	<input type="checkbox"/>
Mr. Jenkins	<input type="checkbox"/>
Mr. Marshall	<input type="checkbox"/>
Mr. Miller, E.S.	<input type="checkbox"/>
Mr. Ponder	<input type="checkbox"/>
Mr. Soyars	<input type="checkbox"/>
Mr. Walters	<input type="checkbox"/>
Tele. Room	<input type="checkbox"/>
Mr. Kinley	<input type="checkbox"/>
Mr. Armstrong	<input type="checkbox"/>
Ms. Herwig	<input type="checkbox"/>
Mrs. Neenan	<input type="checkbox"/>

Jeh

SECRET ARMY ORGANIZATION (SAO). EXTREMIST MATTERS.

9

ON OCTOBER TWENTY SIX, NINETEEN SEVENTY TWO, SA JOHN KEEFE, U.S. SECRET-SERVICE, SAN DIEGO, TELEPHONICALLY ADVISED THAT THE SENATOR MC GOVERN HEADQUARTERS AT EL CAJON, CALIFORNIA, HAD ON THE MORNING OF OCTOBER TWENTY SIX, NINETEEN SEVENTY TWO, RECEIVED SEVERAL TELEPHONE CALLS FROM AN ANONYMOUS MALE. THE CALLER ALLEGED THAT SOMETIME IN THE PAST HE HAD BEEN OFFERED A QUANTITY OF EXPLOSIVES BY AN FBI INFORMANT INVOLVED WITH THE SECRET ARMY ORGANIZATION (SAO). THE PURPOSE WAS TO USE THE EXPLOSIVES TO BOMB THE MC GOVERN HEADQUARTERS. ACCORDING TO THE ANONYMOUS CALLER HE, THE CALLER, REFUSED TO COOPERATE OR TO ACCEPT THE EXPLOSIVES. THE CALLER FURTHER ALLEGED THAT AS A RESULT OF HIS REFUSAL TO COOPERATE HIS BUSINESS, A HERTZ RENTAL FRANCHISE AT THE NINE ZERO ZERO BLOCK OF BROADWAY,

Ri

[Handwritten signature]

END PAGE ONE

ST-101

RFC-2 157-23577-67

7 OCT 31 1972

6 NOV 8 1972

EXT. INT. SEC.

PAGE TWO

SD 157-2815

EL CAJON, CALIFORNIA, HAD BEEN BLOWN UP. AFTER LISTENING TO A
MC GOVERN SPEECH ON OCTOBER TWENTY FIVE, NINETEEN SEVENTY TWO,
THE CALLER BELIEVED IT WAS HIS DUTY TO MAKE THE ABOVE INFORMATION
PUBLIC WHICH PROMPTED HIS TELEPHONE CALLS TO THE MC GOVERN
HEADQUARTERS. THE CALLER CLAIMED THAT HE WAS AFRAID TO REPORT
THIS MATTER PREVIOUSLY. THE CALLER WAS REFERRED TO MC GOVERN
HEADQUARTERS IN SAN DIEGO, CALIFORNIA, WHERE HE SPOKE TO MRS.
JOY MASON REQUESTING THAT SHE MAKE THE ABOVE INFORMATION
PUBLIC. MRS. MASON REFUSED TO DO SO IN VIEW OF THE FACT THE
ANONYMOUS CALLER REFUSED TO IDENTIFY HIMSELF.
THE CALLER DECLINED TO IDENTIFY HIMSELF BUT ADVISED MRS.
MASON THAT HE WOULD CONSULT WITH HIS ATTORNEY ON OCTOBER
TWENTY SIX, NINETEEN SEVENTY TWO, FOLLOWING WHICH HE, BASED
ON THE ATTORNEY'S ADVICE WOULD POSSIBLY RECONTACT MRS. MASON
ON THE MORNING OF OCTOBER TWENTY SEVEN, NINETEEN SEVENTY TWO.
END PAGE TWO

2

PAGE THREE

SD 157-2815

SAN DIEGO NOTES THAT AN EXPLOSION OCCURRED ON SEPTEMBER FIVE, NINETEEN SEVENTY TWO IN THE VICINITY OF A GULF SERVICE STATION LOCATE IN THE NINE HUNDRED BLOCK OF BROADWAY, EL CAJON, CALIFORNIA, OPERATED BY ONE CALVIN HENDELL FOX, CALIF. RESULTING IN MONOR DAMAGE TO A HERTZ RENTAL VEHICLE AT THAT LOCATION. IT IS TO BE FURTHER NOTED THAT CALVIN HENDELL FOX HAS RECENTLY BEEN INDICTED BY THE SAN DIEGO COUNTY GRAND JURY FOR PERJURY IN CONNECTION WITH HIS TESTIMONY AT THE LOCAL TRIAL OF WILLIAM FRANCIS YAKOPEC, AN ALLEGED MEMBER OF THE SAO, WHO WAS CONVICTED AND SENTENCED ON OCTOBER TWERTY FIVE, NINETEEN SEVENTY TWO, FOR ATTEMPTED MURDER IN COMMECTION WITH THE BOMBING OF THE GUILD THEATER.

IT IS TO BE FURTHER NOTED THAT HOWARD BARRY GODFREY, A FORMER FBI INFORMANT HAD TESTIFIED FOR THE PROSECUTION IN THE YAKOPEC TRIAL AND IS SCHEDULED FOR FURTHER TESTIMONY IN CONNECTION WITH TRIALS OF OTHER ALLEGED MEMBERS OF THE SAO AT SAN DIEGO.

END PAGE THREE

3

PAGE FOUR

SD 157-2815

SAN DIEGO NOTES THAT CALVIN HENDELL FOX HAS PREVIOUSLY
ATTEMPTED TO DISCREDIT HOWARD BARRY GODFREY AND EMBARASS^R
THE FBI WHILE SEEKING PERSONAL NOTORIETY.

THE INFORMATION CONCERNING FOX AND GODFREY HAS BEEN
FURNISHED TO SA KEEFE, U.S. SECRET SERVICE. SA KEEFE WAS
ADVISED THAT THE FBI INTENDS TO INTERVIEW HOWARD BARRY GODFREY
IN THE MATTER.

ON OCTOBER TWENTY SIX, NINETEEN SEVENTY TWO, THE FOLLOWING
LOCAL AUTHORITIES WERE ALERTED TO THE FACTS AS FURNISHED BY
THE ANONYMOUS CALLER: DETECTIVE RUBIEN BRANDON, SAN DIEGO,
POLICE DEPARTMENT AND DEPUTY SHERIFF NANCY BYRD, SPECIAL
INVESTIGATIONS, SAN DIEGO SHERIFF'S OFFICE.

THE SAO IS AN ANTICOMMUNIST, PARAMILITARY ORGANIZATION
FORMED IN NINETEEN SEVENTY ONE IN SAN DIEGO, CALIFORNIA.
IT INTENDS TO CONDUCT INTELLIGENCE-TYPE OPERATIONS AND TO
OFFER TRAINING IN URBAN GUERRILLA WARFARE TO BE USED AGAINST
"LEFTWING GROUPS" AND SUSPECTED ENEMIES OF THE UNITED STATES.

END PAGE FOUR

4

PAGE FIVE

SD 157-2815

ADMINISTRATIVE

SACRAMENTO. IMMEDIATELY INTERVIEW HOWARD BARRY GODFREY
AND SUTEL RESULTS TO BUREAU AND SAN DIEGO.

SAN DIEGO WILL FURNISH RESULTS OF GODFREY INTERVIEW TO
SECRET SERVICE.

THE BUREAU SHOULD NOTE THAT THIS MATTER MAY RECEIVE
CONSIDERABLE PRESS COVERAGE.

OTHER THAN TO ADVISE U.S. SECRET SERVICE OF RESULT OF
GODFREY INTERVIEW, SAN DIEGO INTENDS TO TAKE NO FURTHER
ACTION IN THIS MATTER.

PENDING.

END

FBI VDM WASH DC

CLR

T's Miller
D. E. Mobre
G. C. Moore
Paterson
Trainor

cc- MR. TRAINOR
ROOM 7. A 9&D

5

Domestic Intelligence Division

INFORMATIVE NOTE

Date 10/25/72

Attached indicates William Francis Yakopec, member of the paramilitary, ultra-conservative, anticommunist Secret Army Organization, who has been on trial in Superior Court, San Diego County, San Diego, California, was sentenced 10/24/72 to one year to life imprisonment. Yakopec found guilty of igniting and exploding a destructive device, assault with intent to commit murder, simple assault, and possession of explosives near a habitation.

Yakopec in Superior Court before being sentenced admitted bombing a San Diego theater 6/19/72 thus substantiating testimony given during trial by former FBI informant Howard Barry Godfrey. Member of District Attorney's Office, San Diego County, stated arrest and conviction of Yakopec directly attributable to information and testimony by Godfrey.

Dissemination of attached being made to Secret Service and Internal Security Division of the Department.

WCP:aso
WCS

GEM

ESM
RCS

WGC

8/57

NR 02 SD CODE

1:16 PM URGENT 10-25-72 JBE

TO: ACTING DIRECTOR

(ATTN: DID) (157-26763)

FROM: SAN DIEGO (157-2815) 2 P

FEDERAL BUREAU OF INVESTIGATION
COMMUNICATIONS SECTION

OCT 25 1972

TELETYPE

Mr. Felt	✓
Mr. Baker	✓
Mr. Bates	✓
Mr. Bishop	✓
Mr. Callahan	✓
Mr. Cleveland	✓
Mr. Conrad	✓
Mr. Dalbey	✓
Mr. Jenkins	✓
Mr. Marshall	✓
Mr. Miller	✓
Mr. Ponder	✓
Mr. Soyars	✓
Mr. Walters	✓
Tele. Room	✓
Mr. Kinley	✓
Mr. Armstrong	✓
Ms. Herwig	✓
Mrs. Neenan	✓

John P.C. Moore

SECRET ARMY ORGANIZATION (SAP). EXTREMIST MATTER.

ON OCTOBER TWENTY FOUR, NINETEEN SEVENTY TWO, LARRY WILSON, DISTRICT ATTORNEY'S OFFICE, SAN DIEGO COUNTY, CALIFORNIA, ADVISED THAT WILLIAM FRANCIS YAKOPEC WAS SENTENCED ON OCTOBER TWENTY FOUR, NINETEEN SEVENTY TWO, TO ONE YEAR TO LIFE AND REMANDED IMMEDIATELY TO CUSTODY. YAKOPEC HAD BEEN FOUND GUILTY OF IGNITING AND EXPLODING A DESTRUCTIVE DEVICE, ASSAULT WITH INTENT TO COMMIT MURDER, SIMPLE ASSAULT AND POSSESSION OF EXPLOSIVES NEAR A HABITATION.

BEFORE SENTENCING YAKOPEC ADMITTED IN SUPERIOR COURT BEFORE JUDGE ROBERT W. CONYERS THAT HE LIED ON THE WITNESS STAND WHEN HE DENIED BOMBING THE GUILD THEATER AT SAN DIEGO ON JUNE NINETEEN, NINETEEN SEVENTY TWO. YAKOPEC THEN CONFESSED HIS GUILT IN THE GUILD THEATER BOMBING BEFORE JUDGE CONYERS THUS SUBSTANTIATING INFORMATION INITIALLY FURNISHED

END PAGE ONE

Deleted Copy Sent Novak/Porter 100
by Letter 9/15/75 rlz
Per FCIA Request cu
70 NOV 7 1972
F430

rec 130
SS
RIS
10/27/72
WSP

5 - Patterson

PAGE TWO

SD 157-2815

BY AND LATER TESTIFIED TO BY FORMER FBI INFORMANT HOWARD
BARRY GODFREY.

LARRY WILSON, SUPRA, STATED THAT THE ARREST AND CONVICTION
OF YAKOPEC WAS DIRECTLY ATTRIBUTABLE TO THE INFORMATION AND
TESTIMONY PROVIDED BY GODFREY.

ADMINISTRATIVE

RE SAN DIEGO AIRTEL TO BUREAU DATED OCTOBER SIX, NINETEEN
SEVENTY TWO.

LHM FOLLOWS.

END

GWS WASH DC FBI CLR

T's Miller
D. E. Moore
G. C. Moore
Patterson
ISD
Secret Service
A. W. Gray
Trainor

CC- MR. TRAINOR
ROOM 712-A 9&D

FEDERAL BUREAU OF INVESTIGATION
COMMUNICATIONS SECTION

OCT 27 1972

TELETYPE

NR 08 SC CODE

11:35 PM NITEL 10-26-72 OGW

TO: ACTING DIRECTOR (ATTN: DID) (157-23577)

SAC, SAN DIEGO (157-2815)

FROM: SAC, SACRAMENTO (157-2195)

Mr. Felt	_____
Mr. Baker	_____
Mr. Bates	_____
Mr. Bishop	_____
Mr. Callahan	_____
Mr. Cleveland	_____
Mr. Conrad	_____
Mr. Dalbey	_____
Mr. Jenkins	_____
Mr. Marshall	_____
Mr. Miller, E.S.	_____
Mr. Ponder	_____
Mr. Soyars	_____
Mr. Walters	_____
Tele. Room	_____
Mr. Kinley	_____
Mr. Armstrong	_____
Ms. Herwig	_____
Mrs. Neenan	_____

SECRET ARMY ORGANIZATION (SAO)

EXTREMIST MATTERS

G. G. Malone
SLY
He

RE SD TELETYPE OCTOBER TWENTYSIX INSTANT.

THIS DATE HOWARD BARRY GODFREY, EMPLOYEE OF CALIFORNIA DIVISION OF FORESTRY, SACRAMENTO ADVISED EARLIER TODAY HAD LEARNED OF FACTS AS SET FORTH IN RETEL FROM DEPUTY DISTRICT ATTORNEY JOHN HEWICKER, COUNTY OF SAN DIEGO AND AGREED WITH DEDUCTION THAT CALVIN HENDELL FOX MOST LIKELY RESPONSIBLE FOR CALL TO MCGOVERN HQS IN SD.

GODFREY REGARDS FOX AS MENTAL CASE AND DENIES HAVING OFFERED EXPLOSIVES IN PAST TO FOX OR EVER DISCUSSING BLOWING UP MCGOVERN HQS. GODFREY SAID HE ARRIVED SC ABOUT TWO MONTHS AGO AFTER IDENTITY EXPOSED IN SD AND ALLEGES BOTH LEFT AND RIGHT WING ELEMENTS THERE ATTEMPTING TO DETERMINE HIS WHEREABOUTS. GODFREY COULD SHED NO FURTHER LIGHT AS TO IDENTITY OF ANONYMOUS CALLER IN SAN DIEGO.

ST-113 REC 44

77-65

END.

20 OCT 31 1972

3JM FBI WASHDC
NOV 1 1972 MR. TRAINOR
ROOM 712-A 9&B
1363

5 P. W. P.

917

Mr. Fell	_____
Mr. Baker	_____
Mr. Bates	_____
Mr. Bishop	_____
Mr. Callahan	_____
Mr. Cleveland	_____
Mr. Conrad	_____
Mr. Dalbey	_____
Mr. Jenkins	_____
Mr. Marshall	_____
Mr. <i>[Signature]</i>	_____
Mr. Ponder	_____
Mr. Soyars	_____
Mr. Walters	_____
Tele. Room	_____
Mr. Kinley	_____
Mr. Armstrong	_____
Ms. Herwig	_____
Mrs. Neenan	_____

United States Senate

October 11, 1972

Respectfully referred to:

Federal Bureau of Investigation

Misfeldt
[Signature]

0/22
[Signature]

EX-100

40 OCT 13 1972

#32

Because of the desire of this office to be responsive to all inquiries and communications, your consideration of the attached is requested. Your findings and views, in duplicate form, along with return of the enclosure, will be appreciated by

Ramy Saldivata
U.S.S.

157-23577-

NOT RECORDED
191 OCT 24 1972

Form #2 *SCL*

ack
10-17-72
IWD: ego

cc - Bureau
of Alcohol, Tobacco
by form

2- ENCLOSURE ENCLOSURE

57 OCT 26 1972

14 OCT 18 1972

CORRESPONDENCE

62-107261-3807

ORIGINAL FILED IN

OCT 6 1972

STUART A. HOENIG
882 E. GLENN ST.
TUCSON, ARIZONA 85719

October 4, 1972

Senator Barry Goldwater
Senate Office Building
Washington, D. C. 20515

Dear Senator Goldwater:

The enclosed clipping appeared on page 23 of the Tucson Daily Citizen for October 2, 1972. As a loyal American citizen, hunter and member of the National Rifle Association, I resent the implications of this article. The idea that a typical member "likes guns....." is just the sort of reasoning that the communists use in all their propoganda. The fact that it comes from a Government Agency is cause for concern.

Perhaps the Minutemen are right in suggesting that there is a Communist-Socialist clique in government, the Internal Revenue Service might be the place to look for it at that.

I hope you can bring this problem to the attention of the proper authority.

Respectfully yours,



Stuart A. Hoening

SAH:en
encl.

cc: National Rifle Association
Washington, D. C. 20036

*original
returned*

ENCLOSURE

ENCLOSURE

157-23572

U.S. studies right-wing state groups

PHOENIX (AP) — The Minutemen and Secret Army Organization are relatively dormant as right-wing para-military groups in Arizona, federal agents say, but not much is known about the new Sons of Liberty.

Spokesmen for the Alcohol, Tobacco and Firearms Division of the Federal Bureau of Investigation and Internal Revenue Service agents say the three groups are among radical organizations that pose a threat to the government, and therefore are under surveillance.

The government agents say they rely on informants and intercepted pamphlets for information about paramilitary operations. There is no specific information about membership, but agents believe it to be small.

Agents would disclose no names of persons they believe to be members of the groups.

"They're gun enthusiasts and every time I meet up with one I discover he likes to hunt," an agent said in describing a typical member. "He likes guns and that factor prompts him to gravitate to these people."

The Secret Army Organization and Minutemen contend that a "Communist-Socialist clique" already controls the government.

original returned

NOTE

← THIS

ENCLOSURE

157-23577-

Domestic Intelligence Division

INFORMATIVE NOTE

Date 10/11/72

You were previously advised of local prosecutive action against William Francis Yakopec, a member of the white extremist Secret Army Organization (SAO), at San Diego, California. He was charged with assault with intent to commit murder.

Attached reports two other men have been indicted under California State statute on perjury charges arising from their testimony in the Yakopec case. One of these men, an extremist subject, testified the FBI had planted a document in his files; the other testified he had advised the FBI of the location of a large number of stolen firearms and that he had sold many of these weapons to another man, a former FBI informant.

Copy furnished to Internal Security Division of the Department.

HEM:owc

EM/HEM

GCM/JP
WAC

FEDERAL BUREAU OF INVESTIGATION
COMMUNICATIONS SECTION

OCT 11 1972

TELETYPE

Mr. Felt	_____
Mr. Baker	_____
Mr. Bates	_____
Mr. Bishop	_____
Mr. Callahan	_____
Mr. Cleveland	_____
Mr. Conrad	_____
Mr. Dalbey	_____
Mr. Jenkins	_____
Mr. Marshall	_____
Mr. Mohr	_____
Mr. Ponder	_____
Mr. Soyars	_____
Mr. Walters	_____
Tele. Room	_____
Mr. Kinley	_____
Mr. Armstrong	_____
Ms. Herwig	_____
Mrs. Neenan	_____

NR 23 SD PLAIN

11:03 PM URGENT 10-10-72 GKF

TO ACTING DIRECTOR (157-23577) (ATTN: D. I. D.)

FROM SAN DIEGO (157-2815) 2 P

SECRET ARMY ORGANIZATION (SAO).

AMORE

LARRY WILSON, CRIMINAL INVESTIGATOR, OFFICE OF DISTRICT ATTORNEY,
COUNTY OF SAN DIEGO, ADVISED ON OCTOBER TENTH, NINETEEN SEVENTY-
TWO, THAT CALVIN HENDELL FOX, AN ALLEGED MEMBER OF THE SAO,
WAS PLACED UNDER ARREST BY THE SAN DIEGO DISTRICT ATTORNEY'S OFFICE
AT ONE TEN PM ON OCTOBER TENTH, NINETEEN SEVENTY-TWO. FOX
WAS INDICTED BY A SAN DIEGO COUNTY GRAND JURY ON OCTOBER TENTH, NINE-
TEEN SEVENTY-TWO FOR VIOLATION OF THE CALIFORNIA PENAL CODE, SEC-
TION ONE ONE EIGHT, PERJURY RESULTED FROM FOX'S TESTIMONY IN THE
YAKOPEC TRIAL WHERE HE TESTIFIED THAT THE FBI HAD PLANTED A SAO DOCUMENT
IN HIS FILES AND THAT HOWARD BARRY GODFREY, AN FBI INFORMANT, HAD
VISITED HIS GASOLINE STATION THREE TIMES ON THE DAY FOLLOWING THE
BOMBING OF THE GUILD THEATRE ON JUNE NINETEENTH, NINETEEN SEVENTY-TWO. GOD-
FREY WORKED A TWENTY-FOUR SHIFT FOR THE SAN DIEGO
FIRE DEPARTMENT ON THE DAY FOLLOWING THE BOMBING OF THE GUILD THEATRE,

END PAGE ONE

Deleted Copy Sent Douglas Porter

by Letter 9/4/75

Per FOIA Request cb

2 cc. ISD Adm. data deleted

3- Patton

6 OCT 18 1972

PAGE TWO

SD 157-2815

THE DAY FOX TESTIFIED GODFREY HAD VISITED HIS SERVICE STATION THREE TIMES.

FOX IS CURRENTLY HELD ON TEN THOUSAND DOLLARS BAIL.

DINO MARTINELLI WHO TESTIFIED IN THE YAKOPEC TRIAL THAT HE HAD ADVISED THE FBI OF THE WHEREABOUTS OF A LARGE NUMBER OF ARMS STOLEN FROM CAMP PENDLETON TWO YEARS AGO AND THAT HE HAD SOLD A LARGE QUANTITY OF THESE GUNS TO HOWARD GODFREY WAS ALSO INDICTED ON OCTOBER TENTH, NINETEEN SEVENTY-TWO, FOR VIOLATION OF SECTION ONE ONE EIGHT OF THE CALIFORNIA PENAL CODE.

MARTINELLI IS PRESENTLY INCARCERATED IN THE SAN DIEGO COUNTY JAIL ON A PREVIOUS CHARGE. BAIL WAS SET AT TEN THOUSAND DOLLARS.

THE SECRET ARMY ORGANIZATION IS AN ANTI-COMMUNIST, PARAMILITARY ORGANIZATION FORMED IN NINETEEN SEVENTY-ONE IN SAN DIEGO CALIFORNIA. IT INTENDS TO CONDUCT INTELLIGENCE-TYPE OPERATIONS AND TO OFFER TRAINING IN URBAN GUERRILLA WARFARE TO BE USED AGAINST QUOTE LEFT-WING GROUPS UNQUOTE AND SUSPECTED ENEMIES OF THE UNITED STATES.

ADMINISTRATIVE;

REFERENCE

RE SAN DIEGO AIRTEL AND LHM TO BUREAU DATED TEN THREE SEVENTY-TWO

CAPTIONED CALVIN HENDELL FOX-EXTREMIST MATTER-SECRET ARMY ORGANIZATION.

END

~~CORRECTION-SEC~~

ki

FBI

Date: 10/6/72

ESH/CSA

Transmit the following in _____
(Type in plaintext or code)

Via AIRTEL AIRMAIL REGISTERED
(Priority)

TO: ACTING DIRECTOR, FBI (157-23577)
ATTENTION: DID

[Handwritten signature]

FROM: SAC, SAN DIEGO (157-2815) (P)

SECRET ARMY ORGANIZATION (SAO)
EXTREMIST MATTERS

On 10/2/72, WILLIAM FRANCIS YAKOPEC, an alleged member of the SAO, was found guilty on charges of Igniting and Exploding a Destructive Device or Explosives; Assault with Intent to Commit Murder, Simple Assault, Assault with a Deadly Weapon on a Police Officer, and Possession of Explosives near a Habitation. YAKOPEC was convicted in a jury trial in San Diego County Superior Court after he exploded a bomb in the Guild Theater in San Diego, California, on 6/19/72.

This conviction was a result of information furnished by former FBI informant HOWARD BARRY GODFREY.

- (2) - Bureau (AM-RM)
- 3 - San Diego (2 - 157-2815)
- (1 - 157-1820)

EMP:ejt
(5)

EX-114
REC-37 / 157-23577-63

Deleted Copy Sent Douglas Porter
by Letter 01/72
Per FOIA Request CU

25 OCT 9 1972

OCT 13 1972

EXT. INT. SEC. *[Handwritten initials]*

Approved: [Signature] Sent _____ M Per _____

Special Agent in Charge

Memorandum

TO : ACTING DIRECTOR, FBI

DATE: 10/2/72

FROM : SAC, PHOENIX (157-1173) (C)

SUBJECT: SECRET ARMY ORGANIZATION (SAO)
EXTREMIST MATTERS

Re Phoenix letter and LHM dated 5/31/72 and Bureau
0-1 dated 9/12/72.

informant identifies informant states that
he does not a single established member of the SAO in the
State of Arizona. Since the inception of the organization
one year ago, seven people in Arizona have communicated with
the SAO through the San Diego mail drop. The San Diego group
passed the inquiries on *informant*. These individuals were
identified in referenced letter.

The Phoenix Office did not open files on these
individuals for the following reasons:

INFORMANTS

*C
R*

- (2) - Bureau (RM) (AM)
 - 1 - San Diego (RM) (Info)
 - 2 - Phoenix
(1 - 157-Mathews)
- CLC:gjk
(5)

EX-105

REC-75

157-2317-62

OCT 5 1972

OCT 13 1972



Buy U.S. Savings Bonds Regularly on the Payroll Savings Plan

EXT. SECURITY SEC.

PX 157-1173
CLC:gjk

CONFIDENTIAL

SOURCE

A file is being opened on R. J. MATHEWS, JR., EM-Sons of Liberty, 2401 West Southern, Phoenix, who has been identified with the latter group. No communication is being submitted concerning the other individuals mentioned above in the absence of a basis upon which to pursue an investigation.

Domestic Intelligence Division

INFORMATIVE NOTE

Date 10/5/72

William Francis Yakopec, member of white extremist Secret Army Organization (SAO), is being tried, Superior Court, San Diego (SD), California, for assault to commit murder. Calvin Hendell Fox, subject of pending extremist matters investigation, on 9/18/72 as defense witness testified FBI planted in his personal files on 5/18/72 letter from SAO accepting Fox as member. In 6/72 Fox made allegations regarding Special Agents (SAs) illegally entering a file cabinet at his service station. Inquiry by SAC, SD, found Fox's allegations baseless.

Attached indicates SA Arthur J. Hooper testified 9/26/72 refuting Fox's testimony. Prior Departmental authority had been granted for this testimony. Gregory L. Pitman, former employee of Fox, also testified FBI Agents had not removed or inserted papers from Fox's file cabinet and prior to Agents' visit he had observed SAO literature and partially completed SAO application in Fox's files. Superior Court Judge Robert W. Conyers stated "Fox's claims could be filed under P for paranoia."

WCP:aso

DPT

cc/SCJ
Wick
Edwards

UNITED STATES GOVERNMENT

Memorandum

- Felt _____
- Baker _____
- Bates _____
- Beckwith _____
- Callahan _____
- Cleveland _____
- Conrad _____
- Dalbey _____
- Jenkins _____
- Marshall _____
- Milner _____
- Ponder _____
- Soyars _____
- Walters _____
- Tele. Room _____
- Mr. Kinley _____
- Mr. Armstrong _____
- Ms. Herwig _____
- Mrs. Neenan _____

TO : ACTING DIRECTOR, FBI (157-23577)
ATTENTION: DID

DATE: 9/27/72

FROM : SAC, SAN DIEGO (157-2815) (P)

SUBJECT: SECRET ARMY ORGANIZATION
EM

Re San Diego nitel to Bureau dated 9/20/72.

On 9/26/72, SA ARTHUR J. HOOPER testified in the WILLIAM FRANCIS YAKOPEC trial in Superior Court of the County of San Diego without incident. SA HOOPER was called as a rebuttal witness for the prosecution concerning the testimony of CALVIN HENDELL FOX (Bufile 157-2033), that Special Agents planted a Secret Army Organization document in his files at his Gulf Station in El Cajon, California, on May 18, 1972.

GREGORY L. PITMAN testified that CALVIN FOX had left him in charge of FOX's Gulf Station in FOX's absence during the middle and latter part of May, 1972. PITMAN testified that he was present when Special Agents visited FOX's station in an effort to determine the license number of the automobile in which FOX was en route to Washington, D.C. PITMAN testified the Special Agents did not remove papers from FOX's Gulf Station nor did they insert or leave papers in FOX's file or at his service station. PITMAN further testified that previous to the visit of the Special Agents to FOX's Gulf Station, he had found SAO literature and a partially completed SAO membership application in the service station at FOX's Gulf Station.

Judge ROBERT W. CONYERS, having excused the jury, ruled against a defense motion that the Court subpoena files of the Federal Bureau of Investigation pertaining to the investigation of CALVIN HENDELL FOX on May 18, 1972. In

- ③ Bureau (RM)
- (1 - Attn. DID)
- 4 - San Diego (2 - 157-2815)
- (1 - 157-3170) (1 - 157-1820)

REC-63
EX-114 / 57-23577-61

4 OCT 3 1972

AJH:ejt
(7)

OCT 16 1972

W. P. Walters
EXT. INFO SEC.



SD 157-2315

ruling against the defense motion Judge Conyers stated that "Fox's claims could be filed under P for paranoia."

The trial of WILLIAM FRANCIS YAKOPEC continues in Superior Court, San Diego County. Final arguments were presented by the prosecution on 9/27/72.

Assistant Attorney General
Internal Security Division

September 25, 1972

Acting Director, FBI

1 - Mr. D. W. Dalbey
1 - Mr. W. C. Patterson

SECRET ARMY ORGANIZATION
EXTREMIST MATTERS

This is to confirm that on September 21, 1972, Kevin T. Maroney, Deputy Assistant Attorney General, Internal Security Division, advised Special Agent William C. Patterson of this Bureau that authority was granted for Special Agent Arthur J. Hooper to testify in Superior Court, San Diego County, San Diego, California, in the trial of William Francis Yakopec.

Yakopec, a member of the white extremist Secret Army Organization, is charged with attempted murder. A defense witness, Calvin Mendell Fox, has testified the FBI on May 18, 1972, planted in his business files a letter from the Secret Army Organization indicating acceptance of Fox as a Secret Army Organization member.

Mr. Maroney was made aware of the proposed testimony to be given by Special Agent Hooper which concerns the actions of Special Agent Hooper while conducting investigation at Fox's business establishment on May 18, 1972, and which refutes the allegation of Fox that a letter was planted in his personal files by the FBI. Mr. Maroney authorized Special Agent Hooper's testimony in line with the above. If Special Agent Hooper is questioned concerning other than as discussed, he is to advise that in accordance with Code of Federal Regulations, Title 28, Section 16.12, such information acquired while in the performance of official duties as a Special Agent of the FBI cannot be disclosed unless approved by the Attorney General. Additional information required is to be identified and furnished the Department in order that consideration can be given as to whether such information is to be disclosed.

- Felt _____
- Baker _____
- Bates _____
- Bishop _____
- Callaban _____
- Cleveland _____
- Conrad _____
- Dalbey _____
- Jenkins _____
- Marshall _____
- Miller, E.S. _____
- Ponder _____
- Soyars _____
- Walters _____
- Tele. Room _____
- Mr. Kinley _____
- Mr. Armstrong _____

157-23577

WCP:aso (5)

MAILED 20
SEP 26 1972
FBI

REC-64 57-53577-60

SEE NOTE PAGE TWO
18 SEP 26 1972

EX-115

EM

CCM/SA

DEM

HTH
WCP

Assistant Attorney General
Internal Security Division

NOTE:

William Francis Yakopec, a member of the paramilitary, ultraconservative, anticommunist Secret Army Organization (SAO), is on trial in Superior Court, San Diego County, San Diego, California, on a charge of attempted murder. As indicated above, defense witness Calvin Hendell Fox has alleged the FBI planted a document in his personal files on 5/18/72. Fox in May, 1972, was identified by former Bureau informant Howard Barry Godfrey as one of the most rabid and violent new members of the SAO. Godfrey furnished information that Fox, immediately after the attempted assassination of Presidential candidate George Wallace, indicated he was going to Washington, D. C., to do some demonstrating of his own. Investigation was instituted to ascertain description and license number of Fox's automobile and other background information in order to carry out responsibilities regarding protection of Presidential candidates and high Government officials. SA Arthur J. Hopper and former SA Steven L. Christensen on 5/18/72 made inquiry at Fox's service station and an employee of Fox looked through Fox's file cabinet in an attempt to obtain the license number of Fox's automobile. There is no indication documents in this file cabinet were extensively examined by the Agents or that anything was placed in these files. San Diego teletype 9/21/72 contained SA Hooper's proposed testimony which will refute Fox's testimony. This matter has been coordinated with SA James L. Williamson, Office of Legal Counsel.

Domestic Intelligence Division

INFORMATIVE NOTE

Date 9/20/72

SA Earl M. Petersen, San Diego Division, was previously authorized by the Department to testify in Superior Court, San Diego County, San Diego, California, in trial of William Francis Yakopec, a member of the white extremist Secret Army Organization. After testifying 9/18/72 Petersen was served with subpoena duces tecum to produce records, reports, and other material regarding former FBI informant Howard Barry Godfrey. Godfrey had obtained the information on which the charge of assault to commit murder was based. On 9/19/72 Sol Lindenbaum, Executive Assistant to the Attorney General, instructed that SA Petersen would not be authorized to produce the records requested.

Attached indicates San Diego Superior Court Judge Conyers, in out of court conference, was advised of the Department's decision not to produce the records requested. Judge Conyers accepted this decision and indicated SA Petersen's testimony in this regard would not be necessary. Copy of attached being furnished Internal Security Division of the Department.

WCP:was

WCP

EM/GCM

WCP GCM

BRK

61447

FEDERAL BUREAU OF INVESTIGATION
COMMUNICATIONS SECTION

NR 03 SD PLAIN

SEP 20 1972

11:29PM NITEL 9-19-72 GKF

TELETYPE

TO ACTING DIRECTOR (157-23577) (ATTN: D.I.D.)
FROM SAN DIEGO (157-2815) 1P

Mr. Baker	_____
Mr. Bates	_____
Mr. Bishop	_____
Mr. Callahan	_____
Mr. Cleveland	_____
Mr. Conrad	_____
Mr. Dalbey	_____
Mr. Jenkins	_____
Mr. Marshall	_____
Mr. Miller, E.S.	_____
Mr. Ponder	_____
Mr. Soyars	_____
Mr. Walters	_____
Tele. Room	_____
Mr. Kinley	_____
Mr. Armstrong	_____
Ms. Herwig	_____
Mrs. Neenan	_____

SECRET ARMY ORGANIZATION (SAO); EXTREMIST MATTERS

RE SAN DIEGO TELETYPES SEPTEMBER FIFTEEN AND EIGHTEEN LAST AND BUREAU TELETYPE SEPTEMBER NINETEEN INSTANT.

AUSA ROBERT H. FILSINGER MET WITH SUPERIOR COURT JUDGE ROBERT W. CONYERS, DEFENSE COUNSEL FRED HETTER, AND PROSECUTING ATTORNEY RICHARD HUFFMAN IN JUDGE CONYER'S CHAMBERS ON SEPTEMBER NINETEEN INSTANT IN AN "ON RECORD" SESSION. AUSA FILSINGER ADVISED AT THAT TIME THAT THE FEDERAL GOVERNMENT WOULD DECLINE TO PRODUCE RECORDS REQUESTED BY SUPBOENA DUCES TECUM AND BY COURT ORDER. HE ADVISED THAT SA EARL M. PETERSEN WOULD BE AVAILABLE TO TESTIFY CONCERNING THE REFUSAL TO PRODUCE THE RECORDS. JUDGE CONYERS ADVISED AUSA FILSINGER THAT SA PETERSEN'S TESTIMONY IN THIS REGARD WOULD NOT BE NECESSARY AND THAT THE COURT ACCEPTED THE DECISION NOT TO PRODUCE THE RECORDS. JUDGE CONYERS MADE NO COMMENTS REGARDING THE DECISION AND SEEMED TO EXPECT THE REFUSAL. AUSA FILSINGER DID NOT COMMENT TO JUDGE CONYERS REGARDING THE POSSIBILITY OF PRODUCING RECORDS FOR THE COURT AFTER REVIEW BY THE DEPARTMENT.

[Handwritten initials/signature]

[Handwritten signature]

[Handwritten signature]

EX-104

REC-37

157-23577-59

INT. SEC.

SA PETERSEN HAS BEEN ADVISED THAT HE COULD BE RECALLED FOR REBUTAL TESTIMONY.

END 70 SEP 20 1972

335;1 -7 ROOM 712-A 9&D

1-cc - Kevin Manning Dept of AD, ISD

SEP 25 1972

Domestic Intelligence Division

INFORMATIVE NOTE

Date 9/18/72

Attached indicates SA Earl Petersen, San Diego, on 9/18/72 served subpoena duces tecum regarding trial of William Francis Yakopec in Superior Court, San Diego County, San Diego, California. SA Petersen ordered to produce records, notes, reports and other material regarding former FBI informant Howard Berry Godfrey who obtained information on which charge of assault to commit murder based.

This matter will be discussed with Deputy Assistant Attorney General Kevin T. Maroney of Internal Security Division. Being coordinated with Office of Legal Counsel. San Diego Office will be advised telephonically regarding decision concerning material to be disclosed.

GLY:pld

EM
/GLYGCM
/JLD

WGC

FEDERAL BUREAU OF INVESTIGATION
COMMUNICATIONS SECTION

SEP 18 1972

TELETYPE

Mr. Felt	_____
Mr. Baker	_____
Mr. Bates	_____
Mr. Bishop	_____
Mr. Callahan	_____
Mr. Cleveland	_____
Mr. Conrad	_____
Mr. Dalbey	_____
Mr. Jenkins	_____
Mr. Marshall	_____
Mr. Miller, E.S.	_____
Mr. Ponder	_____
Mr. Soyars	_____
Mr. Walters	_____
Tele. Room	_____
Mr. Kinley	_____
Mr. Armstrong	_____
Ms. Herwig	_____
Mrs. Neenan	_____

NR 08 SD PLAIN

7:27PM URGENT 9-18-72 GKF

TO ACTING DIRECTOR (157-26763) 3 P

(ATTN: D. I. D.)

FROM SAN DIEGO (157-2815)

SECRET ARMY ORGANIZATION (SAO), EXTREMIST MATTER.

H. G. Moore

J.

S. W. J. Tellefero

RE SAN DIEGO TELEPHONE CALL TO THE BUREAU TODAY
FURNISHING A FACSIMILE COPY OF A SUBPOENA DUCES TECUM SERVED
ON SA EARL M. PETERSEN BY THE DEFENSE OF THE STATE OF CALIFORNIA
VS. WILLIAM FRANCIS YAKOPEC CALLING FOR THE PRODUCTION OF
"ALL RECORDS, NOTES, REPORTS, AND OTHER MATERIAL REGARDING
HOWARD BERRY GODFREY'S EMPLOYMENT AS AN F. B. I. INFORMANT,
INCLUDING, BUT NOT LIMITED TO, HIS INITIAL APPLICATION
AND LETTER OF RESIGNATION."

EX-105

ON THE AFTERNOON OF SEPTEMBER EIGHTEEN, INSTANT AND
SUBSEQUENT TO REFERENCED SAN DIEGO TELEPHONE CALL, JUDGE

REC-37

157-23577-58

ROBERT W. CONYERS INDICATED AN INTENT TO LIMIT THE MATTER CALLED FOR
IN THE SUBPOENA DUCES TECUM TO ONLY THAT INFORMATION FURNISHED BY

15 SEP 21 1972

GODFREY CONCERNING YAKOPEC DURING THE PERIOD OCTOBER, NINETEEN
SEVENTY ONE TO THE DATE OF YAKOPEC'S ARREST BY THE SAN DIEGO
POLICE DEPARTMENT ON JUNE TWENTY SIX, LAST.

END PAGE ONE

2 cc. ISD
Adm. data deleted

PAGE TWO

SD 157-2815

ON SEPTEMBER EIGHTEEN INSTANT, SA PETERSEN TESTIFIED TO INFORMATION PREVIOUSLY AUTHORIZED BY THE DEPARTMENT OF JUSTICE. THE TESTIMONY WAS ACCEPTED BY THE COURT AND THE COURT STATED THAT WHETHER OR NOT THE GOVERNMENT REFUSED TO COMPLY WITH THE SUBPOENA DUCES TECUM, THAT SA PETERSEN'S TESTIMONY OF SEPTEMBER EIGHTEEN INSTANT WOULD BE ALLOWED TO STAND.

ON SEPTEMBER EIGHTEEN INSTANT, AUSA ROBERT H. FILSINGER, WHO WAS PRESENT DURING SA PETERSEN'S TESTIMONY, IS OF THE OPINION THAT EVEN THE LIMITED DISCLOSURE CALLED FOR IN THE SUBPOENA DUCES TECUM IS UNWARRANTED AND SHOULD NOT BE PROVIDED TO THE DEFENSE. THE REFUSAL TO COMPLY WITH THE SUBPOENA DUCES TECUM SHOULD BE BASED ON THE FACT THAT THE WRITTEN INFORMATION IN THE FBI FILE WAS FURNISHED BY GODFREY TO FORMER SA STEVEN L. CHRISTENSEN WHO IS NOT GOING TO TESTIFY IN THE YAKOPEC TRIAL.

SA PETERSEN WILL TESTIFY THAT HE MADE NO WRITTEN VERBATIM TRANSCRIPTION OF THE INFORMATION FURNISHED BY GODFREY TO SA PETERSEN DURING THE PERIOD IMMEDIATELY PRIOR TO THE YAKOPEC ARREST ON JUNE TWENTY SIX LAST INASMUCH AS AT THAT TIME GODFREY HAD BEEN TURNED OVER AS A WITNESS TO THE LOCAL AUTHORITIES IN THE MATTER.

AUSA FILSINGER IS OF THE OPINION THAT THE COURT WILL NOT INSIST ON COMPLIANCE WITH THE SUBPOENA DUCES TECUM AND WILL NOT INTERPRET REFUSAL TO PRODUCE THE MATERIAL REQUESTED AS AN OBSTRUCTION OF THESE COURT PROCEEDINGS.

END PAGE TWO

PAGE THREE

SD 157-2815

IT IS THEREFORE RECOMMENDED THAT SA PETERSEN DECLINE TO PRODUCE THE MATERIAL CALLED FOR IN THE SUBPOENA DUCES TECUM.

IN AS MUCH AS THE COURT HAS REQUESTED URGENCY IN THE GOVERNMENT ANSWER, AND AUSA FILSINGER HAS ADVISED THE COURT THAT EFFORTS WILL BE MADE TO HAVE THE ANSWER BY NINE O' CLOCK SEPTEMBER NINETEEN NEXT, SAN DIEGO TIME, THE BUREAU IS REQUESTED TO EXPEDITE REFERRAL OF THIS MATTER TO THE JUSTICE DEPARTMENT.

END

JDJ FBI WASH DC CRL

CC - MR. TRAINOR
ROOM 712-A 2&D

Domestic Intelligence Division

INFORMATIVE NOTE

Date 9/22/72

William Frances Yakopec, a member of the white extremist Secret Army Organization (SAO), currently is on trial Supreme Court, San Diego County, San Diego, California, on charge of assault to commit murder. Calvin Hendell Fox, subject of a pending extremist matters investigation, on 5/18 as defense witness testified that on 5/18/72 the FBI planted in his personal files a letter from SAO accepting him as SAO member.

Fox in 6/72 made allegations regarding Special Agents illegally entering a file cabinet at his service station. SA San Diego reviewed investigation and found no basis for allegation. Fox's employee, Gregory Lawrence Pitman, opened file cabinet of Fox.

On 9/21/72 Departmental authority obtained for SA Arthur J. Hooper to testify in Yakopec trial to refute Fox's testimony. Attached indicates Gregory Lawrence Pitman on 9/21/72 furnished signed statement substantiating that Special Agents had not planted material in Fox's file and that he observed an incompleted SAO application prior to visit by Special Agents. Copy of attached being furnished Internal Security Division of the Department.

WCP:egt

WCP FM/HEM

GCM/50 HGC

FEDERAL BUREAU OF INVESTIGATION
COMMUNICATIONS SECTION

SEP 22 1972

TELETYPE

Mr. Felt	_____
Mr. Baker	_____
Mr. Bates	_____
Mr. Bishop	_____
Mr. Callahan	_____
Mr. Cleveland	_____
Mr. Conrad	_____
Mr. Dalbey	_____
Mr. Jenkins	_____
Mr. Marshall	_____
Mr. Miller	_____
Mr. Ponder	_____
Mr. Soyars	_____
Mr. Walters	_____
Tele. Room	_____
Mr. Kinley	_____
Mr. Armstrong	_____
Ms. Herwig	_____
Mrs. Neenan	_____

NR 07 SD PLAIN

11:16PM NITEL 9-21-72 GKF

TO ACTING DIRECTOR (157-23577) (ATTN: D.I.D.)
FROM SAN DIEGO (157-2815) 1P

SECRET ARMY ORGANIZATION (SAO); EXTREMIST MATTER.

RE SAN DIEGO TELETYPE TO BUREAU SEPTEMBER TWENTY,
LAST.

ON SEPTEMBER TWENTY ONE, INSTANT, GREGORY LAWRENCE
PITMAN (REFERRED TO IN REFERENCED SAN DIEGO TELETYPE AS
GREG PITKIN), FURNISHED BUREAU AGENTS A SIGNED STATEMENT
IN WHICH HE SUBSTANTIATED THE FACT THAT SPECIAL SPECIAL AGENTS DID
NOT PLACE ANY MATERIAL IN THE FILES OF CALVIN HANDELL
FOX AT FOX'S GULF SERVICE STATION AS ALLEGED BY FOX.
PITMAN FURTHER ADVISED THAT PRIOR TO THE VISIT OF THE
BUREAU AGENTS TO FOX'S STATION, PITMAN OBSERVED A PARTIALLY
COMPLETED APPLICATION FOR MEMBERSHIP IN SAO AT FOX'S

GARAGE.

END

cc MR. TRAINOR
ROOM 712-A 9&D
LNG FBI WA CLR TU AR
54 SEP 28 1972

REC 25 / 157-23577-57
EX-114

17 SEP 25 1972

CODE

TELETYPE

URGENT

1 - Mr. D. J. Dalbey

1 - Mr. W. C. Patterson

9/21/72

TO: SAC, SAN DIEGO (157-2815)

FROM: ACTING DIRECTOR, FBI (157-23577)

SECRET ARMY ORGANIZATION; EXTREMIST MATTERS.

RESDTL SEPTEMBER TWENTY, LAST.

KEVIN T. MARONEY, DEPUTY ASSISTANT ATTORNEY GENERAL, INTERNAL SECURITY DIVISION, DEPARTMENT OF JUSTICE, ON SEPTEMBER TWENTY-ONE, INSTANT, ADVISED AUTHORITY GRANTED FOR SA ARTHUR J. HOOPER TO TESTIFY DURING TRIAL OF WILLIAM FRANCIS YAKOPEC, SUPERIOR COURT, SAN DIEGO COUNTY, SAN DIEGO, CALIFORNIA, IN LINE WITH PROPOSED QUESTIONS AND ANSWERS AS SET FORTH IN REFERENCED TELETYPE. IF QUESTIONED CONCERNING OTHER THAN AS SET FORTH IN REFERENCED TELETYPE, SA HOOPER IS TO ADVISE THAT IN ACCORDANCE WITH CODE OF FEDERAL REGULATIONS, TITLE TWENTY-EIGHT, SECTION SIXTEEN POINT TWELVE, SUCH INFORMATION ACQUIRED WHILE PERFORMING DUTIES AS SPECIAL AGENT CAN NOT BE DISCLOSED UNLESS APPROVED BY THE ATTORNEY GENERAL. ADDITIONAL DATA REQUIRED IS TO BE FURNISHED THE DEPARTMENT IN ORDER THAT CONSIDERATION CAN BE GIVEN AS TO WHETHER SUCH IS TO BE DISCLOSED. ASSISTANT U. S. ATTORNEY ROBERT H. FILSINGER IS TO BE PRESENT DURING TESTIMONY BY SA HOOPER IN ORDER TO PROTECT GOVERNMENT'S INTEREST.

1 - Personnel file of SA Arthur J. Hooper

FEDERAL BUREAU OF INVESTIGATION SEP 25 1972 COMMUNICATIONS SECTION

WCP:was (5) *was*

SEP 21 1972

TELETYPE

NOTE:

William Francis Yakopec, a member of the white extremist Secret Army Organization (SAO), is on trial on charge of assault to commit murder, in Superior Court, San Diego County,

NOTE CONTINUED PAGE TWO

- elt
- aker
- ates
- ishop
- allaha
- leveland
- onrad
- albey
- enkins
- arshall
- iller, E.S.
- onder
- oyars
- alters
- tele. Room
- r. Kinley
- r. Armstrong
- s. Herwig
- s. Neenan

F-211
SEP 28 1972

9/26/72

MAIL ROOM TELETYPE UNIT

GCN

HEH
WCP

Teletype to SAC, San Diego
Re: Secret Army Organization
157-23577

NOTE CONTINUED:

San Diego, California. Calvin Hendell Fox, who has been identified by former Bureau informant Howard Barry Godfrey as a SAO member, was investigated in May, 1972, concerning a trip he was hurriedly making at that time to Washington, D. C. Fox, as a defense witness in the Yakopec trial, on 9/18/72 testified he is not a member of the SAO and produced a letter to him on SAO stationery accepting his application as a SAO member. Fox testified the FBI planted this document in his personal files on 5/18/72. Fox, in June, 1972, made allegations that FBI Agents had illegally opened his personal file cabinet at his business. A review of this investigation and inquiry concerning the actions of the Agents indicated this allegation was false and that an employee of Fox's had opened the file cabinet and that the Agents had made no examination of documents in this cabinet. Referenced teletype set forth proposed questions and answers regarding SA Hooper's testimony who conducted investigation at Fox's place of business and who will refute Fox's testimony. This matter has been coordinated with SA James L. Williamson, Office of Legal Counsel. SA William C. Patterson, on 9/21/72, received instructions set forth from Kevin T. Maroney, Deputy Assistant Attorney General, Internal Security Division.

Domestic Intelligence Division

INFORMATIVE NOTE

Date 9/21/72

William Francis Yakopec, a member of white extremist Secret Army Organization (SAO) currently is on trial, on charge of assault to commit murder, in Superior Court, San Diego County, San Diego, California. Attached indicates Calvin Hendell Fox has testified he is not a SAO member and that the FBI on 5/18/72 planted in his business files a letter from the SAO indicating his acceptance as a SAO member.

Attached indicates Special Agent Arthur J. Hooper, San Diego, to be subpoenaed by the prosecution to testify on rebuttal regarding investigation conducted regarding Fox in May, 1972, and that letter had not been planted by FBI in Fox's files.

Fox has previously made false allegations regarding investigation by San Diego Division Agents. Review of investigation by SAC, San Diego indicated there was no basis to allegations and Agents had acted in legal, ethical manner.

SAC, San Diego recommends testimony of SA Hooper who will be accompanied in court by Assistant U. S. Attorney Filsinger. Domestic Intelligence Division concurs with recommendation. This matter being coordinated with Office of Legal Counsel and will be discussed with Deputy Assistant Attorney General Kevin T. Maroney of the Department. San Diego will be advised.

wf WCP:was

EMGCM

DJD
9/21/72

FEDERAL BUREAU OF INVESTIGATION
COMMUNICATIONS SECTION

SEP 21 1972

NR 12 SD PLAIN

10:07 PM URGENT 9-20-72 GKF

TELETYPE

TO ACTING DIRECTOR (157-23577) (ATTN: D. I. D.)

FROM SAN DIEGO (157-2815) 7P

Mr. Ealy	_____
Mr. Baker	_____
Mr. Bates	_____
Mr. Bishop	_____
Mr. Callahan	_____
Mr. Cleveland	_____
Mr. Conrad	_____
Mr. Dalbey	_____
Mr. Jenkins	_____
Mr. Marshall	_____
Mr. Miller - E.S.	_____
Mr. Ponder	_____
Mr. Soyars	_____
Mr. Walters	_____
Tele. Room	_____
Mr. Kinley	_____
Mr. Armstrong	_____
Ms. Herwig	_____
Mrs. Neenan	_____

SECRET ARMY ORGANIZATION (SAO); EXTREMIST MATTER

RE SAN DIEGO TELETYPE TO BUREAU SEPTEMBER NINETEEN LAST.
TRIAL OF WILLIAM FRANCIS YAKOPEC CONTINUES IN SUPERIOR COURT
SAN DIEGO COUNTY.

[Handwritten signature]

ON SEPTEMBER EIGHTEEN LAST CALVIN HENDELL FOX, BUREAU
FILE NUMBER ONE FIVE SEVEN DASH TWO ZERO THREE THREE, TESTIFIED
AS DEFENSE WITNESS. HE TESTIFIED THAT HE IS NOT A MEMBER OF THE
SAO AND PRODUCED A LETTER TO HIM IN SAO STATIONARY ACCEPTING
HIS APPLICATION AS MEMBER. HE TESTIFIED THAT THE FBI HAD PLANTED
THIS DOCUMENT IN HIS PERSONAL FILES AT HIS GULF SERVICE STATION
IN EL CAJON, CALIFORNIA ON MAY EIGHTEEN

[Handwritten 'Z']

LAST.

EX-116

REC-70

157-23577-55

FOR THE INFORMATION OF THE BUREAU, FOX WAS ENROUTE TO WASHINGTON,
D. C. VIA AUTOMOBILE ON MAY EIGHTEEN LAST AND AGENTS OF THE FBI
WERE ATTEMPTING TO DETERMINE THE LICENSE NUMBER OF HIS AUTOMOBILE
IN ORDER THAT THIS MIGHT BE FURNISHED TO U.S. SECRET SERVICE
AND TO BALTIMORE, IN CONNECTION WITH THE DEPARTURE OF PRESIDENT
NIXON ON HIS TRIP TO WASHINGTON AND WITH THE ATTEMPTED ASSASSIN-
ATION OF ALABAMA GOVERNOR WALLACE. (SEE SAN DIEGO TELETYPE 9/19/72)

s-wsp

END PAGE ONE

Kevin M. ... Asst. AC
58 SEP 20 1972

PAGE TWO

ED/28// SD 157-2815

BUREAU DATED JUNE TWELVE LAST CAPTIONED CALVIN HENDELL FOX,
EXTREMIST MATTERS DASH SAO.)

SA ARTHUR J. HOOPER WILL BE SUBPOENED BY THE PROSECUTION
TO TESTIFY ON REBUTTAL. HE WILL BE SUBJECT TO CROSS EXAMINATION.
THE PROSECUTION WILL ASK AND HE WILL ANSWER AS FOLLOWS:

QUESTION ONE: LENGTH OF SERVICE AND ASSIGNMENT?

ANSWER: I HAVE BEEN A SPECIAL AGENT OF THE FBI FOR ONE YEAR AND
NINE MONTHS. I AM PRESENTLY ASSIGNED TO THE SAN DIEGO DIVISION.

QUESTION TWO: DID AGENTS GO TO CALVIN FOX'S SERVICE STATION ON
MAY EIGHTEEN NINETEEN SEVENTY TWO?

ANSWER: YES SIR.

QUESTION FOUR: FOR WHAT PURPOSE DID YOU GO TO THE SERVICE STATION?

ANSWER: TO OBTAIN THE LICENSE NUMBER OF THE VEHICLE IN WHICH MR.
FOX WAS ENROUTE TO WASHINGTON, D. C.

QUESTION FIVE: WHY?

ANSWER: WE WANTED TO FURNISH THE LICENSE NUMBER AND THE DESCRIPTION
OF THE CAR FOX WAS DRIVING TO U. S. SECRET SERVICE AND TO FBI WASH-
INGTON AND BALTIMORE.

QUESTION SIX: WHY DID YOU WANT TO GIVE THEM THIS INFORMATION?

END PAGE TWO

ANSWER: THIS WAS SHORTLY AFTER THE SHOOTING OF GOVERNOR WALLACE. FOX HAD ALLEGEDLY INDICATED HE WAS GOING TO WASHINGTON D. C. TO DO SOME DEMONSTRATING OF HIS OWN. WE FELT HIS PRESENCE IN WASHINGTON D. C. WOULD BE OF INTEREST TO SECRET SERVICE IN VIEW OF THEIR PROTECTION RESPONSIBILITIES.

QUESTION SEVEN: DID YOU ATTEMPT TO OBTAIN THE LICENSE NUMBER OF THIS VEHICLE BY OTHER MEANS PRIOR TO GOING TO FOX'S SERVICE STATION?

ANSWER: YES SIR.

QUESTION EIGHT: WHAT HAD YOU DONE?

ANSWER: WE HAD CONTACTED THE DEPARTMENT OF MOTOR VEHICLES AND SEVERAL INDIVIDUALS IN AN ATTEMPT TO OBTAIN THE LICENSE NUMBER WITHOUT SUCCESS.

QUESTION NINE: WHO DID YOU CONTACT AT THE STATION?

ANSWER: THE GAS STATION ATTENDANT.

QUESTION TEN: WHAT DID YOU ASK THE ATTENDANT?

ANSWER: WE IDENTIFIED OURSELVES AS SPECIAL AGENTS OF THE FBI AND ASKED HIM IF HE KNEW WHERE MR. FOX COULD BE CONTACTED IN WASHINGTON, D. C. AND IF HE KNEW THE LICENSE NUMBER OF THE CAR HE WAS DRIVING.

QUESTION ELEVEN: WHAT WAS HIS ANSWER?

ANSWER: HE STATED HE DIDN'T KNOW.

QUESTION TWELVE: WHAT HAPPENED THEN?

END PAGE THREE

ANSWER: WE ASKED HIM IF HE KNEW THE LICENSE NUMBER OF THE CAR USED BY FOX. HE STATED HE DIDN'T KNOW ANYTHING ABOUT MR. FOX OR HIS TRAVELS. WE THEN ASKED HIM WHO HE WAS TO CONTACT IN CASE OF AN EMERGENCY. HE REPLIED THAT GREG PITKIN WAS LEFT IN CHARGE OF THE STATION BY FOX. WHEN WE ASKED IF HE HAD PITKIN'S ADDRESS HE NOTED THAT PITKIN WAS THE DAY-MANAGER AT WHITE'S GULF STATION IN EL CAJON AND WE COULD LOCATE HIM THERE.

QUESTION THIRTEEN: DID YOU THEN CONTACT GREG PITKIN?

ANSWER: YES WE DID.

QUESTION FOURTEEN: AND WHAT HAPPENED?

ANSWER: WE IDENTIFIED OURSELVES AS SPECIAL AGENTS OF THE FBI AND ADVISED PITKIN THAT WE WERE INTERESTED IN THE LICENSE NUMBER OF THE CAR DRIVEN BY FOX TO WASHINGTON D.C. WE THEN ASKED HIM IF HE HAD FOX'S ADDRESS OR TELEPHONE NUMBER WHERE HE COULD BE REACHED IN WASHINGTON D.C. PITKIN REPLIED THAT HE DIDN'T. WE THEN ASKED IF HE KNEW THE LICENSE NUMBER OF THE CAR USED BY FOX. HE STATED HE DIDN'T BUT THAT HE HAD SEEN THE REGISTRATION FORM FOR FOX'S CAR THE PREVIOUS EVENING IN THE FILE CABINET IN FOX'S GAS STATION WHILE HUNTING FOR THE RENTAL LOGS FOR THE RYDER TRUCKS HANDLED BY THAT STATION. HE THEN STATED HE COULD SUPPLY THE LICENSE NUMBER BY LOOKING AT THE REGISTRATION FORM IN THE FILE CABINET.

QUESTION FIFTEEN: DID YOU THEN PROCEED TO FOX'S STATION?

END PAGE FOUR

PAGE FIVE

SD 157-2815

ANSWER YES SIR.

QUESTION SIXTEEN: DID YOU OPEN THE FILE CABINET?

ANSWER: NO SIR.

QUESTION SEVENTEEN: WHO OPENED THE CABINET?

ANSWER: GREG PITKIN.

QUESTION EIGHTEEN: DID HE HAVE AUTHORIZATION TO OPEN THE CABINET?

ANSWER: WE ASKED HIM AND SAID HE DID NOTING THAT HE HAD
TO OPEN THE CABINET ALMOST DAILY IN ORDER TO SECURE THE LOG BOOKS FOR
THE RYDER RENTAL FRANCHISE.

QUESTION NINETEEN: DID YOU EXAMINE THE CONTENTS OF THE FILE CABINET?

ANSWER: NO.

QUESTION TWENTY: WHAT HAPPENED THEN?

ANSWER: GREG PITKIN OPENED THE TOP FILE DRAWER OF THE CABINET
AND TOOK OUT FOUR OR FIVE REGISTRATION FORMS HOLDING EACH UP TO
BE EXAMINED AND ASKING, " IS THIS THE ONE".....TO WHICH WE
REPLIED EACH TIME ... NO.

QUESTION TWENTY-ONE: IS THAT ALL THAT HAPPENED?

ANSWER: AFTER WE HAD ASCERTAINED THAT THE REGISTRATION FORMS HELD

END PAGE FIVE

PAGE SIX

SD 157-2815

BY PITKIN WERE OF NO ASSISTANCE, PITKIN THEN PUT THEM BACK IN THE DRAWER AND CLOSED IT. HE THEN OPENED THE REMAINING THREE DRAWERS IN QUICK SUCCESSION STATING THAT HE DIDN'T THINK THE REGISTRATION FORM WOULD BE IN THE CABINET IF IT WASN'T IN THE TOP DRAWER.

QUESTION TWENTY-TWO: DID YOU EXAMINE THE FILES IN THE LAST THREE FILE DRAWERS OPENED BY PITKIN?

ANSWER: NO.

QUESTION TWENTY-THREE: DID YOU TAKE ANY PAGES FROM THOSE DRAWERS IN THE FILE CABINET?

ANSWER: NO.

QUESTION TWENTY-FOUR: DID YOU PLACE ANY PAPERS INTO THE FILE CABINET?

ANSWER: NO.

QUESTION TWENTY-FIVE: DID YOU PLACE ANY LETTERS WITH SAO LETTER-HEAD STAMPED ON IT INTO THE FILE CABINET AT CALVIN FOX S STATION.?

ANSWER: NO.

END PAGE SIX

PAGE SEVEN

SD 157-2815

AUSA ROBERT H. FILSINGER WILL BE IN COURT DURING TESTIMONY
BY SA ARTHUR J. HOOPER.

SA HOOPER WILL BE CALLED TO TESTIFY ON SEPTEMBER TWENTY
SECOND NEXT.

SAN DIEGO RECOMMENDS SA HOOPER TESTIFY.

REQUEST OF BUREAU: OBTAIN OPINION OF DEPARTMENT ASTO
ABOVE TESTIMONY.

END

LNG FBI WA CLR TU AR

cc-MR. TRAINOR
ROOM: 712-A 9&D

The Attorney General

September 21, 1972

Acting Director, FBI

- 1 - Mr. D. W. Dalbey
(Mr. J. L. Williamson)
- 1 - Mr. W. C. Patterson

SECRET ARMY ORGANIZATION
EXTREMIST MATTERS

This is to confirm that on September 19, 1972, Special Agents William C. Patterson and James L. Williamson of this Bureau had a conference with Mr. Sol Lindenbaum of your office regarding whether certain records of this Bureau pertaining to a former Bureau informant were to be produced in answer to a subpoena duces tecum in Superior Court, San Diego County, San Diego, California, in the trial of William Francis Yakopec. The subpoena duces tecum was served on Special Agent Earl M. Petersen on September 18, 1972, after he had testified in the trial of Yakopec, a member of the white extremist Secret Army Organization. Yakopec is charged with attempt to commit murder and possession of explosives based on information obtained by former Bureau informant Howard Barry Godfrey.

Mr. Lindenbaum instructed that Special Agent Earl M. Petersen under the instruction of the Attorney General was to decline to furnish the records in Superior Court, San Diego County, San Diego, California, which the subpoena duces tecum ordered produced.

Our San Diego Office has advised that Assistant United States Attorney Robert H. Filsinger on September 19, 1972, met in the chambers of Superior Court Judge Robert W. Conyers and advised him that the records requested by the subpoena duces tecum would not be produced in court. Judge Conyers indicated the court accepted the decision not to produce the records and that Special Agent Petersen's testimony in this regard would not be necessary.

- 1 - The Deputy Attorney General
 - 1 - Assistant Attorney General
- Internal Security Division

157-23577

WCP:aso

SEE NOTE PAGE TWO

MAIL ROOM TELETYPE UNIT

MAILED 2
SEP 21 1972
FBI

- Felt
- Baker
- Bates
- Bishop
- Callahan
- Cleveland
- Conrad
- Dalbey
- Jenkins
- Marshall
- Miller, E.S.
- Ponder
- Soyars
- Walters
- Tele. Room
- Mr. Kinley
- Mr. Armstrong
- Ms. Herwig
- Ms. Neenan

EX-116 REC-33 157-23577-54

15 SEP 22 1972

EM GCM

HEH DA
WCP

The Attorney General

NOTE:

William Francis Yakopec, a member of the paramilitary, ultraconservative, anticommunist Secret Army Organization, is currently undergoing trial in Superior Court, San Diego County, San Diego, California, on charges of attempt to commit murder and possession of explosives based on information furnished by former Bureau informant Howard Barry Godfrey. As indicated, SA Petersen was served with a subpoena duces tecum calling for production on 9/19/72 of "all records, notes, reports and other material" regarding Godfrey's serving as an informant for the FBI. This letter is to confirm that a conference was held on 9/19/72 and that Sol Lindenbaum, Executive Assistant to the Attorney General, instructed that the material requested in the subpoena duces tecum was not to be produced in court. This information was furnished the San Diego Office by telephone and by confirming teletype on 9/19/72. San Diego teletype 9/19/72 furnished information regarding SA Petersen's testimony not being required and that the material would not have to be produced in court.

FEDERAL BUREAU OF INVESTIGATION
COMMUNICATIONS SECTION

SEP 16 1972

TELETYPE NR 11 SD CODE

1116PM 9-15-72 URGENT KDV

TO: ACTING DIRECTOR, FBI (157-23577) (ATTN: DID)

FROM: SAC, SAN DIEGO (157-2815)

Mr. Felt	_____
Mr. Baker	_____
Mr. Bates	_____
Mr. Bishop	_____
Mr. Callahan	_____
Mr. Cleveland	_____
Mr. Conrad	_____
Mr. Dalbey	_____
Mr. Jenkins	_____
Mr. Marshall	_____
Mr. Miller, E.S.	_____
Mr. Ponder	_____
Mr. Soyars	_____
Mr. Walters	_____
Tele. Room	_____
Mr. Kinley	_____
Mr. Armstrong	_____
Ms. Herwig	_____
Mrs. Neenan	_____

*ESM
RIP*

J.C. [unclear]

MIN [unclear]

SECRET ARMY ORGANIZATION (SAO)

EXTREMIST MATTERS

RE BUREAU LETTER TO ASSISTANT ATTORNEY GENERAL, INTERNAL SECURITY DIVISION SEPTEMBER FIFTH LAST, COPY TO SAN DIEGO.

SA EARL M. PETERSEN WAS SCHEDULED TO TESTIFY DURING THE AFTERNOON OF SEPTEMBER FIFTEEN INSTANT IN THE TRIAL OF WILLIAM FRANCIS YAKOPEC. HE WAS ACCOMPANIED BY AUSA SHELDON DEUTCH.

PRIOR TO THE BEGINNING OF THE COURT SESSION, DEPUTY DISTRICT ATTORNEY RICHARD HUFFMAN STATED THAT HE WOULD HAVE LIKED TO ASK FURTHER QUESTIONS SUCH AS QUOTE DID THE INFORMANT CONTACT YOU ON JUNE TWENTY FIFTH NINETEEN SEVENTY TWO AND FURNISH YOU INFORMATION REGARDING THE LOCATION OF CERTAIN EXPLOSIVES? END QUOTE. HE ALSO ASKED SA PETERSEN IF HE COULD ANSWER A QUESTION SUCH AS QUOTE DID THE FBI EVER HAVE A WIRETAP ON THE TELEPHONE OF THE INFORMANT? END QUOTE.

REC-33

157-23577-53

AS A RESULT OF THIS DISCUSSION, AUSA DEUTCH TELEPHONICALLY CONTACTED KEVIN T. MARONEY, DEPUTY ASSISTANT ATTORNEY GENERAL IN WASHINGTON, D.C. ASKING FOR ADVICE AS TO WHETHER SA PETERSEN COULD ANSWER THESE AND SIMILAR QUESTIONS BEYOND THE SPECIFIC QUESTIONS AUTHORIZED PREVIOUSLY.

15 SEP 19 1972

EX-105

END PAGE ONE

5-W. [unclear]

58 SEP 22 1972

MR. MARONEY ADVISED THAT SA PETERSEN COULD ANSWER QUESTIONS RELATING TO THE SEARCH WARRENT AFFIDAVIT AND SUCH QUESTIONS AS TO WHETHER THE FBI HAD A WIRETAP ON THE INFORMANT'S TELEPHONE. QUESTIONS SHOULD BE LIMITED TO THE OFFENSE FOR WHICH YAKOPEC IS BEING TRIED AND SHOULD NOT INVOLVE OTHER PERSONS OR ADMINISTRATIVE PROCEDURES. UCAB SA PETERSEN WILL TESTIFY AS APPROVED BY MR. MARONEY. SA PETERSEN IS SCHEDULED TO TESTIFY AT TEN AM SEPTEMBER EIGHTEEN NEXT.

ON SEPTEMBER FIFTEEN INSTANT A CONFERENCE WAS HELD IN THE CHAMBERS OF SAN DIEGO COUNTY SUPERIOR COURT JUDGE ROBERT W. CONYERS. PRESENT WERE JUDGE CONYERS, FRED HETTER ATTORNEYFOR YAKOPEC, DEPUTY DISTRICT ATTORNEY RICHARD HUFFMAN AND AUSA SHELDON DEUTCH. WHEN THIS CONFERENCE ENDED, AUSA DEUTCH ADVISED SA PETERSEN THAT JUDGE CONYERS WAS CRITICAL OF THE FEDERAL GOVERNMENT TO THE POINT OF USING OBSCENITIES, STATING IN SUBSTANCE THAT THE ATTORNEY GENERAL HAD NO RIGHT TO INTERFERE WITH TESTIMONY IN HIS COURT BY PLACING ANY RESTRICTIONS ON TESTIMONY BY FBI EMPLOYEES. AUSA DEUTCH PRESENTED THE GOVERNMENT POSITION AND HAS ASKED FOR A TRANSCRIPT OF THE QUOTE ON THE RECORD UNQUOTE PORTION OF THE CONFERENCE. HE STATED THAT HE WILL MAKE AVAILABLE TO THE FBI A COPY OF THE TRANSCRIPT WHEN RECEIVED.

SAN DIEGO WILL KEEP THE BUREAU ADVISED OF ALL PERTINENT DEVELOPMENTS.

SA PETERSEN WAS NOT REQUIRED TO TESTIFY IN THE PRE TRIAL HEARING REGARDING THE SEARCH WARRENT AFFIDAVIT.

THE TRIAL OF GEORGE MITCHELL HOOVER HAS BEEN CONTINUED UNTIL OCTOBER TWENTY FIVE NEXT.

END PAGE TWO

~~MR. TRAINOR~~
~~ROOM 712A 9&D~~

PAGE THREE

SD 157-2815

THE TRIAL OF JERRY LYNN DAVIS HAS BEEN CONTINUED UNTIL
NOVEMBER THIRTEEN NEXT.

P.

END

LNG FBI WA CLR

ce —
MR. TRAINOR
ROOM 712-A 9&D

Handwritten initials/signature

CODE

TELETYPE

NITEL

ST
u

TO SAC SAN DIEGO (157-2815)

EX-104

9/1/72

FROM ACTING DIRECTOR FBI (157-23577) - 52

REC-42

1 - Mr. D. W. Dalbey

1 - Mr. Patterson

SECRET ARMY ORGANIZATION (SAO), EXTREMIST MATTERS.

RESDTL AUGUST TWENTY-NINE LAST.

KEVIN T. MARONEY, DEPUTY ASSISTANT ATTORNEY GENERAL, INTERNAL SECURITY DIVISION, DEPARTMENT OF JUSTICE, ON SEPTEMBER ONE INSTANT ADVISED AUTHORITY GRANTED FOR FORMER SA STEVEN L. CHRISTENSEN TO TESTIFY IN ANSWER TO THE PROSECUTION'S QUESTIONS DURING THE TRIAL OF GEORGE MITCHELL HOOVER, SUPERIOR COURT, SAN DIEGO COUNTY, SAN DIEGO, CALIFORNIA, AS WERE FURNISHED THE BUREAU BY TELECOPIER ON AUGUST

TWENTY-NINE LAST. ASSISTANT UNITED STATES ATTORNEY (AUSA) PHILLIP

H. FILSINGER, SAN DIEGO, WILL BE ADVISED SEPTEMBER SEVEN NEXT BY MR. MARONEY THAT TESTIMONY OF CHRISTENSEN IS TO BE LIMITED TO ANSWERING ABOVE-MENTIONED QUESTIONS OF WHICH AUSA IS AWARE. A CONFERENCE IS TO BE HELD BY AUSA FILSINGER WITH FORMER SA CHRISTENSEN PRIOR TO HIS APPEARANCE AS A WITNESS TO INSURE HE UNDERSTANDS LIMITATIONS OF HIS TESTIMONY AND THAT IN ACCORDANCE WITH CODE OF

RECEIVED
SEP 2 11 42 AM '72
COMMUNICATIONS SECTION

1 - Personnel File of SA Steven L. Christensen

- Felt _____
- Baker _____
- Bates _____
- Bishop _____
- Callahan _____
- Cleveland _____
- Conrad _____
- Dalbey _____
- Jenkins _____
- Marshall _____
- Miller, E.S. _____
- Ponder _____
- Soyars _____
- Walters _____
- Tele. Room _____
- Mr. Kinley _____
- Mr. Armstrong _____
- Ms. Herwig _____
- Mrs. Neenan _____

WCP:aso (5)

FEDERAL BUREAU OF INVESTIGATION
COMMUNICATIONS SECTION

SEE NOTE PAGE TWO

SEP 2 1972

TELETYPE

SEP 15 1972

MAIL ROOM TELETYPE UNIT

GCM

HEH

Handwritten initials/signature

TELETYPE TO SAN DIEGO
RE: SECRET ARMY ORGANIZATION (SAO)
157-23577

FEDERAL REGULATIONS, TITLE EIGHTEEN, SECTION SIXTEEN POINT TWELVE, DATA OBTAINED WHILE IN PERFORMANCE OF DUTIES AS SA CANNOT BE DISCLOSED UNLESS APPROVED BY THE ATTORNEY GENERAL. ADDITIONAL DATA REQUIRED IS TO BE FURNISHED THE DEPARTMENT IN ORDER THAT CONSIDERATION CAN BE GIVEN AS TO WHETHER SUCH IS TO BE DISCLOSED. AUSA IS TO BE PRESENT DURING TESTIMONY BY CHRISTENSEN IN ORDER TO PROTECT GOVERNMENT'S INTEREST.

MR. MARONEY REQUESTED AUSA BE ADVISED BY SAN DIEGO OFFICE OF THE ABOVE AND INDICATED IT WOULD BE DESIRABLE FOR KNOWLEDGEABLE SAS OF SAN DIEGO OFFICE TO BE PRESENT DURING CONFERENCE WITH CHRISTENSEN AND AUSA.

NOTE:

Former Bureau informant Howard Barry Godfrey in 1/72 furnished information to former SA Christensen that SAO member George Mitchell Hoover was responsible for wounding by shooting of Paula Tharp on 1/6/72. Godfrey after shooting turned gun used over to former SA Christensen who retained gun at his residence and indicated informant said gun had been disposed of. After Godfrey was turned over to SDPD to obtain prosecution of several SAO members existence of gun was revealed and it was recovered from Christensen's home on 7/5/72. On 7/6/72 after acknowledging receipt of the gun from Godfrey and admitting concealing it and placing false information in Bureau files, Christensen submitted his resignation effective 7/6/72. San Diego being advised by teletype in order to facilitate briefing of Christensen.

FEDERAL BUREAU OF INVESTIGATION
COMMUNICATIONS SECTION

AUG 30 1972

TELETYPE

Mr. Baker	_____
Mr. Bates	_____
Mr. Bishop	_____
Mr. Callahan	_____
Mr. Cleveland	_____
Mr. Conrad	_____
Mr. Dalbey	_____
Mr. Jenkins	_____
Mr. Marshall	_____
Mr. Miller, E.S.	_____
Mr. Ponder	_____
Mr. Soyars	_____
Mr. Walters	_____
Tele. Room	_____
Mr. Kinley	_____
Mr. Armstrong	_____
Ms. Herwig	_____
Mrs. Neenan	_____

EM/DM

Handwritten initials and scribbles

NR 07 SD FLAIN

9:27PM NITEL 8-29-72 .LC

TO ACTING DIRECTOR (157-23577)

FROM SAN DIEGO (157-2815) 6P

SECRET ARMY ORGANIZATION (SAO), EXTREMIST MATTER.

RESAN DIEGO AIRTELS TO THE BUREAU AUGUST TWENTYFOUR AND TWENTYEIGHT, LAST; AND SAN DIEGO TELEPHONE CALL TO BUREAU AUGUST TWENTYNINE, INSTANT.

ON AUGUST TWENTYEIGHT, LAST, JOHN A. HEWICKER, II, DEPUTY DISTRICT ATTORNEY, SAN DIEGO COUNTY, ADVISED THAT FORMER SA STEVEN L. CHRISTENSEN HAS BEEN REQUESTED TO TESTIFY FOR THE PROSECUTION IN THE LOCAL TRIAL OF GEORGE MITCHELL HOOVER ON SEPTEMBER SEVEN, NEXT, AT SAN DIEGO. HEWICKER FURNISHED A LIST OF QUESTIONS TO BE ASKED OF CHRISTENSEN BY THE PROSECUTION. THE LIST OF QUESTIONS WAS FURNISHED TO THE BUREAU BY TELECOPIER ON AUGUST TWENTYNINE, INSTANT.

END PAGE ONE

REC-42 157-23577-52
EX-104
1-cc Kevin [unclear]
ASST A [unclear]
Internal Security Division
8/30/72 WRP

5-WRP

22 SEP 12 1972

SD 157-2815

PAGE TWO

new cover
ON AUGUST TWENTYNINE, INSTANT, HEWICKER REITERATED THAT SPECIAL AGENTS EARL M. PETERSEN AND C. JORDAN NAYLOR, SAN DIEGO, WILL ALSO BE NECESSARY WITNESSES FOR THE PROSECUTION IN THE TRIAL OF HOOVER ON SEPTEMBER SEVEN, NEXT. HEWICKER HAS NOT AS YET PREPARED A LIST OF THE QUESTIONS TO BE ASKED OF SAS PETERSEN AND NAYLOR AT THE HOOVER TRIAL.

ON AUGUST TWENTYEIGHT, LAST, RICHARD HUFFMAN, DEPUTY DISTRICT ATTORNEY, SAN DIEGO COUNTY, FURNISHED A LIST OF THE QUESTIONS TO BE ASKED BY THE PROSECUTION OF SA PETERSEN AT THE YAKOPEC TRIAL ON SEPTEMBER SIX, NEXT. THE LIST AND PROPOSED ANSWERS ARE AS FOLLOWS:

ONE. QUESTION: HOW LONG HAVE YOU BEEN ASSIGNED AS A SPECIAL AGENT IN THE SAN DIEGO OFFICE OF THE FBI?

ANSWER: SINCE JULY, NINETEEN SIXTYSEVEN.

TWO. QUESTION: DO YOU KNOW A PERSON BY THE NAME OF HOWARD B. GODFREY?

ANSWER: YES.

END PAGE TWO

SD 157-2815

PAGE THREE

THREE. QUESTION: HOW LONG HAVE YOU ^NKNOW HIM?

ANSWER: ABOUT TWO AND ONE HALF YEARS.

FOUR. QUESTION: HAS HE EVER PERFORMED ANY SERVICES
FOR THE FBI?

ANSWER: YES.

FIVE. QUESTION: IN WHAT CAPACITY?

ANSWER: HE FURNISHED INFORMATION TO THE FBI CONCERNING
MATTERS OF INTEREST TO THE FBI.

SIX. QUESTION: FOR WHAT PERIOD OF TIME?

ANSWER: SINCE NINETEEN SIXTY SEVEN.

SEVEN. QUESTION: WAS HE A PAID INFORMANT?

ANSWER. YES HE WAS.

EIGHT. QUESTION: WAS HE ASSIGNED TO INFILTRATE ANY
PARTICULAR GROUP OR GROUPS?

ANSWER. YES HE WAS.

NINE. QUESTION: WHAT PARTICULAR GROUPS WAS HE ASSIGNED
TO INFILTRATE?

END PAGE THREE

PAGE FOUR

SD 157-2815

ANSWER: THE MINUTEMEN AND THE SECRET ARMY ORGANIZATION.

TEN. QUESTION: HOW LONG DID YOU WORK WITH MR. GODFREY IN HIS CAPACITY AS AN INFORMANT?

ANSWER: MR. GODFREY HAS CONTACTED ME ON OCCASION FOR ABOUT TWO YEARS.

ELEVEN. QUESTION: WERE YOU THE PRIMARY AGENT RESPONSIBLE FOR MR. GODFREY?

ANSWER: ONLY SINCE JULY TEN, NINETEEN SEVENTYTWO.

TWELVE. QUESTION: WHO WERE THE PRIMARY AGENTS?

ANSWER. SPECIAL AGENT JORDAN NAYLOR AND FORMER SPECIAL AGENT STEVEN CHRISTENSEN.

THIRTEEN. QUESTION: WHAT WAS YOUR RESPONSIBILITY FOR MR. GODFREY?

ANSWER: I MAINTAINED CONTACT WITH HIM WHEN CHRISTENSEN WAS NOT AVAILABLE.

FOURTEEN. QUESTION: DID MR. GODFREY REPORT REGULARLY TO THE FBI CONCERNING THE ACTIVITIES OF THE SECRET ARMY ORGANIZATION?

ANSWER: YES HE DID.

END PAGE FOUR

PAGE FIVE

SD 157-2815

FIFTEEN. QUESTION: HOW OFTEN DID HE REPORT?

ANSWER: ON PRACTICALLY A DAILY BASIS.

SIXTEEN. QUESTION: WERE YOU PRESENT WHEN MR. GODFREY WAS FIRST MADE AVAILABLE AS A WITNESS TO CALIFORNIA AUTHORITIES?

ANSWER: YES.

SEVENTEEN. QUESTION: WHEN DID THIS TAKE PLACE?

ANSWER: JUNE TWENTYSIX, NINETEEN SEVENTYTWO.

AS OF THE PRESENT, FORMER SA CHRISTENSEN WILL BE CALLED AS A WITNESS FOR THE PROSECUTION ONLY AT THE TRIAL OF HOOVER.

CLOSE CONTACT IS BEING MAINTAINED WITH HEWICKER AND HUFFMAN TO OBTAIN THE PROPOSED QUESTIONS TO BE PUT TO SAS NAYLOR AND PETERSEN AT THE TRIAL OF HOOVER ON SEPTEMBER SEVEN, NEXT, AND OF SA PETERSEN AT THE TRIAL OF HOOVER ON SEPTEMBER SEVEN, NEXT, AND OF SA PETERSEN AT THE TRIAL OF DAVIS ON SEPTEMBER THIRTEEN, NEXT. THE LISTS OF THESE QUESTIONS AND THE PROPOSED ANSWERS WILL BE FURNISHED TO THE BUREAU AS SOON AS RECEIVED BY SAN DIEGO.

END PAGE FIVE

SD 157-2815

PAGE SIX

THE BUREAU IS REQUESTED TO OBTAIN ATTORNEY GENERAL'S
APPROVAL FOR THE PROPOSED TESTIMONY OF FORMER SA CHRISTENSEN
AND OF SA PETERSEN. UPON RECEIPT OF ATTORNEY GENERAL'S
APPROVAL, SAN DIEGO WILL COORDINATE THIS MATTER WITH
AUSA ROBERT H. FILSINGER, SAN DIEGO.

END

HOLD

BJM FBI WASHDC

ACK FOR NR009 & 007

003 R RELAY

cc — MR. TRAINOR
ROOM Z12-A 9&D

1 - Mr. D. W. Dalbey
1 - Mr. W. C. Patterson

Assistant Attorney General
Internal Security Division

September 7, 1972

Acting Director, FBI

SECRET ARMY ORGANIZATION
EXTREMIST MATTERS

This is to confirm that on September 1, 1972, Kevin T. Maroney, Deputy Assistant Attorney General, Internal Security Division, advised Special Agent William C. Patterson that authority was granted for former Special Agent Steven L. Christensen to testify in Superior Court, San Diego County, San Diego, California, during the trial of George Mitchell Hoover.

George Mitchell Hoover, a member of the white extremist Secret Army Organization is charged with attempted murder based on information furnished by former Bureau informant, Howard Barry Godfrey, that Hoover was responsible for the shooting of Paula Tharp on January 6, 1972, in San Diego.

Mr. Maroney was made aware of the proposed questions to be asked former Special Agent Christensen by the prosecution which concern his relationship with former Bureau informant Godfrey, his receipt from Godfrey of the gun used in the shooting and its retention by him.

Mr. Maroney authorized testimony of former SA Christensen in answering the proposed questions. If questioned concerning other than as discussed, former SA Christensen is to advise that in accordance with Code of Federal Regulations, Title 28, Section 16.12, such information acquired while in performance of his official duties as a Special Agent of the FBI cannot be disclosed unless approved by the Attorney General. Additional

REC-65

EX-114 157-23577

MAILED 8
SEP 7 - 1972

SEE NOTE FOR SAC, SAN DIEGO, CALIF.
PAGE TWO

- Felt _____
- Baker _____
- Bates _____
- Bishop _____
- Callahan _____
- Cleveland _____
- Conrad _____
- Dalbey _____
- Jenkins _____
- Marshall _____
- Miller, E.S. _____
- Ponder _____
- Soyars _____
- Walters _____
- Tele. Room _____
- Mr. Kinley _____
- Mr. Armstrong _____
- Ms. Herwig _____
- Mrs. Neenan _____

WCP:was
(8)

SEE NOTE PAGE TWO

58 SEP 12 1972

MAIL ROOM TELETYPE UNIT

Assistant Attorney General
Internal Security Division

information required during the trial is to be identified and furnished the Department in order that consideration can be given as to whether such information is to be disclosed.

NOTE FOR SAC, SAN DIEGO:

ReDStel 8/29/72 and Butel 9/1/72.

This will confirm that authority has been obtained for the appearance of former SA Steven L. Christensen in Superior Court, San Diego County, San Diego, California, as outlined in this letter.

NOTE:

See memorandum G. C. Moore to E. S. Miller dated 8/31/72, that authorized contact with the Department.

UNITED STATES GOVERNMENT

Memorandum

TO : Mr. E. S. Miller

FROM : G. C. Moore *GCM*

SUBJECT: SECRET ARMY ORGANIZATION
EXTREMIST MATTERS

1 - Inspector Trimbach

1 - Mr. D. W. Dalbey

DATE: 8/31/72

1 - Mr. H. N. Bassett *EM*

1 - Mr. E. S. Miller

1 - Mr. G. C. Moore

1 - Mr. W. C. Patterson

7

- Felt _____
- Baker _____
- Bates _____
- Bishop _____
- Callahan _____
- Cleveland _____
- Conrad _____
- Dalbey _____
- Jenkins _____
- Marshall _____
- Miller, E.S.
- Ponder _____
- Soyars _____
- Walters _____
- Tele. Room _____
- Mr. Kinley _____
- Mr. Armstrong _____
- Ms. Herwig _____
- Mrs. Neenan _____

gcm, Moore

Purpose of this memorandum is to obtain authority to contact Internal Security Division, Department of Justice, concerning testimony of former Special Agent (SA) Steven L. Christensen, who is to appear as witness for the prosecution on 9/7/72 in Superior Court, San Diego County, San Diego, California, in trial of George Mitchell Hoover, a member of the white extremist Secret Army Organization (SAO).

Former SA Christensen was assigned to the San Diego Office and was handling former extremist informant Howard Barry Godfrey, a member of the Minutemen and an officer in the SAO. In January, 1972, Godfrey reported that on 1/6/72 SAO member Hoover fired a shot into the residence of New Left activist Peter Bohmer which wounded Paula Tharp. Christensen received this information from Godfrey and subsequently furnished the information to the San Diego Police Department (SDPD). Godfrey's identity as the source of the information was not furnished the SDPD at that time.

EX-114 REC-65 157-23577-51

In June, 1972, Godfrey reported that SAO member William Francis Yakopec was responsible for bombing a San Diego movie theater on 6/19/72 and was in possession of explosives. Based on information furnished by the informant Godfrey the SDPD arrested Yakopec, Hoover and four other SAO members. Yakopec and Hoover were charged with attempted murder and possession of explosives. In order to obtain successful local prosecution of Hoover, Yakopec and the other SAO members, the informant Godfrey was turned over to the SDPD. Subsequently, it was learned the gun used in the shooting of Tharp had been stolen by Godfrey and that the gun was given to former SA Christensen after the shooting. The gun was retained in Christensen's home until turned over to the SDPD on 7/5/72.

Enclosure
157-23577

1 - Personnel File of SA Steven L. Christensen
WCP:aso (8)

CONTINUED - OVER 8 1972

5 - [Signature]

150

Memorandum to Mr. E. S. Miller
Re: Secret Army Organization
157-23577

Christensen on 7/6/72, after admitting to the Special Agent in Charge, San Diego, that he had made false entries in the Bureau records regarding the gun, submitted his resignation. Christensen indicated he had retained the gun as Godfrey had indicated he did not desire to testify and therefore was attempting to protect the informant Godfrey. Although not subject to subpoena as he is residing outside California, Christensen has tentatively indicated a willingness to testify in the trial of Hoover. A list of the prosecution's questions to be asked Christensen was furnished (see attached questions) since information obtained by Christensen while he was an FBI Agent cannot be revealed in state court without prior authority from the Department.

This matter has been coordinated with SA James L. Williamson, Office of Legal Counsel. Questions to be asked by the prosecution appear to involve no objectionable area. Testimony of Christensen could possibly cause adverse comments in the news media regarding his concealment of the gun which had been used in the commission of a felony. The alternative is not to authorize his appearance which would have an adverse effect on the prosecution of Hoover. In view of the above, it is recommended no objection be made to the testimony of Christensen.

ACTION:

If you approve, Kevin T. Maroney, Deputy Assistant Attorney General, Internal Security Division of the Department, will be contacted to obtain authority for the testimony of former SA Steven L. Christensen on 9/7/72 in Superior Court, San Diego County, San Diego, California, in line with the above.

wcp

HEA

DEMO

WGC

AS

Received 8/29/72
from San Diego office
by telephone, WCP

On August 28, 1972, JOHN A. HEWICKER, II, Deputy District Attorney, San Diego County, made available to the FBI the following list of questions to be asked of former SA STEVEN L. CHRISTENSEN on direct examination by the prosecution during the trial of GEORGE MITCHELL HOOVER beginning September 7, 1972:

1. Name?
2. Formerly employed as a Special Agent for the Federal Bureau of Investigation?
3. For how many years?
4. Where was your last duty station?
5. How long were you assigned to the San Diego Office?
6. During the time that you were assigned to the San Diego Office did you become acquainted with an individual known as HOWARD BARRY GODFREY?
7. When approximately did you meet GODFREY?
8. What were the nature of your duties as an FBI Agent at the time you met HOWARD GODFREY?
9. How did you become acquainted with GODFREY?
10. Was there a particular purpose in your becoming acquainted with HOWARD GODFREY?
11. What purpose --?
12. Was there an alternate agent designated as a contact for HOWARD GODFREY?
13. Who?
14. Was GODFREY a paid informant of the FBI?
15. Did the FBI in any way finance the operations of the SAO?
16. How often did GODFREY contact you as an informant?

157-23577-51 File 157-23577
5-WCP

17. How were these contacts made?

18. During what period of time to your knowledge, did Mr. GODFREY act as an informant for the FBI?

19. What type of information did GODFREY furnish you during the period that he was assigned to you as an informant?

20. Do you recall the reported occurrence of the shooting of PAULA THARP in San Diego in January, 1972, at the home of PETER BOHMER?

21. Did Mr. GODFREY make any contact with you regarding the alleged identity of the person who shot PAULA THARP?

22. When?

23. How was contact made?

24. Did Mr. GODFREY at any time furnish you with a weapon which was allegedly the weapon used in the shooting of PAULA THARP?

25. When?

26. Who present?

27. Where were you when the weapon was presented to you by Mr. GODFREY?

28. What type of weapon was it?

29. What did you do with the weapon at the time it was presented to you by Godfrey?

30. Did you notify any local investigative agency of the information furnished to you by GODFREY, relative to the identity of the person who reportedly shot PAULA THARP?

31. What agency?

32. Who did you confide in at that agency?

33. Did you furnish the San Diego Police Department with the weapon at the time you furnished this information regarding the shooting?

34. Why not?

35. Did you tell anyone at the San Diego Police Department that you had possession of the suspect weapon?

36. How long did you have possession of the suspect weapon?

37. Was the weapon ultimately removed from your possession and turned over to local authorities?

38. Approximately when--?

39. Identify if possible this weapon.

FEDERAL BUREAU OF INVESTIGATION
COMMUNICATIONS SECTION

NR 08 SD PLAIN

7:14PM NITEL 8-31-72 LLC

TO ACTING DIRECTOR (157-23577)

FROM SAN DIEGO (157-2815)

AUG 31 1972

TELETYPE

B. Hancock

Mr. Felt	_____
Mr. Baker	_____
Mr. Bates	_____
Mr. Bishop	_____
Mr. Callahan	_____
Mr. Cleveland	_____
Mr. Conrad	_____
Mr. Dalbey	_____
Mr. Jenkins	_____
Mr. Marshall	_____
Mr. Miller, E.S.	_____
Mr. Ponder	_____
Mr. Soyars	_____
Mr. Walters	_____
Tele. Room	_____
Mr. Kinley	_____
Mr. Armstrong	_____
Ms. Herwig	_____
Mrs. Neenan	_____

SECRET ARMY ORGANIZATION (SAO). EXTREMIST MATTERS.

RE SAN DIEGO TEL JULY EIGHTEEN LAST AND JULY NINETEEN LAST.

SA EARL M. PETERSEN HAS RECEIVED SUBPOENA TO APPEAR AS WITNESS FOR PROSECUTION IN TRIAL OF JERRY LYNN DAVIS ON SEPTEMBER THIRTEEN NEXT.

Huffes

SA PETERSEN WAS AUTHORIZED TO TESTIFY BEFORE SAN DIEGO COUNTY GRAND JURY ON JULY NINETEEN LAST. QUESTIONS AND ANSWERS SET FORTH IN SAN DIEGO TELETYPE JULY EIGHTEEN LAST.

E
W.C. Patterson

DEPUTY DISTRICT ATTORNEY FRANK SEXTON, SAN DIEGO COUNTY HAS ADVISED THAT THE QUESTIONS TO BE ASKED OF SA PETERSEN ON SEPTEMBER THIRTEENTH BY THE PROSECUTION WILL BE IDENTICAL WITH THOSE ASKED DURING SA PETERSEN'S APPEARANCE BEFORE THE GRAND JURY. THE ANSWER GIVEN WILL BE THE SAME.

INASMUCH AS SA PETERSEN HAS PREVIOUSLY BEEN AUTHORIZED TO ANSWER THESE QUESTIONS, UACB SA PETERSEN WILL TESTIFY AT THE TRIAL OF DAVIS ON SEPTEMBER THIRTEEN NEXT.

AUSA PHILLIP H. FILSINGER OR ANOTHER AUSA DESIGNATED BY HIM WILL BE PRESENT DURING THIS TESTIMONY. P.

END
LRS FBIHQs ACK FOR THREE CLR

58 SEP 14 1972

MR. TRAINOR
ROOM 712 A 9&S

REC 44 / 157-23577-50

5-WP

1-CC - Neven Marone
9/1/72 WP 17 SEP 7 1972

PERS. REC. UNIT

Assistant Attorney General
Internal Security Division

September 5, 1972

Acting Director, FBI

- 1 - Mr. D. W. Dalbey
- 1 - Mr. W. C. Patterson

SECRET ARMY ORGANIZATION
EXTREMIST MATTERS

This is to confirm that on September 1, 1972, Kevin T. Maroney, Deputy Assistant Attorney General, Internal Security Division, advised Special Agent William C. Patterson that authority was granted for Special Agent Earl M. Petersen to appear as a witness for the prosecution in Superior Court, San Diego County, San Diego, California, in the trial of George Mitchell Hoover, which begins September 7, 1972, and in the trial of Jerry Lynn Davis, which begins September 13, 1972. Authority was also granted for Special Agent C. Jordan Naylor to appear as a witness for the prosecution in the trial of George Mitchell Hoover.

Hoover and Davis are members of the white extremist Secret Army Organization. Hoover is charged with attempted murder based on information developed by former Bureau informant Howard Barry Godfrey that Hoover was responsible for the shooting of Paula Tharp on January 6, 1972, in San Diego, California. Based on information Godfrey furnished, Jerry Lynn Davis is charged with possession of explosives and receiving stolen property.

Mr. Maroney was made aware of the proposed questions to be asked by the prosecution and the answers of Special Agents Petersen and Naylor. In connection with the trial of George Mitchell Hoover, Special Agent Petersen's testimony will concern his relationship with former Bureau informant Godfrey and the recovery of the gun used in the shooting. Special Agent Naylor's testimony will concern his relationship

- 157-23577 - 49 REC 44
- 2 - San Diego (157-2815) ST-111
- 1 - Personnel File of SA Earl M. Petersen
- 1 - Personnel File of SA C. Jordan Naylor

SEE NOTE FOR SAC, SAN DIEGO, PAGE TWO

SEE NOTE PAGE TWO

- Felt _____
- Baker _____
- Bates _____
- Bishop _____
- Callahan _____
- Cleveland _____
- Conrad _____
- Dalbey _____
- Jenkins _____
- Marshall _____
- Miller, E.S. _____
- Ponder _____
- Soyars _____
- Walters _____
- Tele. Room _____
- Mr. Kinley _____
- Mr. Armstrong _____
- Ms. Herwig _____
- Mrs. Neenan _____

MAIL ROOM TELETYPE UNIT

MAILED 5
SEP 5 - 1972

Ⓢ

W.C. EMM DEN GCM HEH WCP

Assistant Attorney General
Internal Security Division

with former Bureau informant Godfrey. In connection with the trial of Davis, Special Agent Petersen's testimony will concern his relationship with the former Bureau informant Godfrey and receipt of information from him regarding Davis' possession of explosives.

Mr. Maroney authorized testimony by Special Agents Petersen and Naylor in line with the above. If questioned concerning other than as discussed, they are to advise that in accordance with Code of Federal Regulations, Title 28, Section 16.12, such information acquired while in the performance of their official duties as Special Agents of the FBI cannot be disclosed unless approved by the Attorney General. Additional information required is to be identified and furnished the Department in order that consideration can be given as to whether such information is to be disclosed.

NOTE FOR SAC, SAN DIEGO:

ReSDtels 8/30 and 8/31/72.

This will confirm that authority has been obtained for the appearance of Special Agents Earl M. Petersen and C. Jordan Naylor in Superior Court, San Diego County, San Diego, California, as outlined in this letter.

NOTE:

Former Bureau informant Howard Barry Godfrey developed information that resulted in trials of George Mitchell-Hoover and Jerry Lynn Davis in Superior Court, San Diego County, San Diego, California. Concerning the trial of Hoover, the gun used in the shooting of Paula Tharp was furnished by Godfrey to former SA Steven L. Christensen who retained the gun at his residence without advising the Bureau of its existence. After Bureau informant Godfrey was turned over to the San Diego Police Department (SDPD) in order to obtain prosecution of several SAO members, it was learned of the existence of the gun. SA Petersen accompanied SDPD officers to the home of former SA Christensen on 7/5/72 and recovered the gun. SA Christensen on 7/6/72 after acknowledging receipt of the gun from Godfrey submitted his resignation

NOTE CONTINUED PAGE THREE

Assistant Attorney General
Internal Security Division

NOTE CONTINUED:

effective 7/6/72. SA Naylor originally developed Godfrey as a criminal informant and turned him over to former SA Christensen. This matter has been coordinated with Inspector John A. Mintz. Office of Legal Counsel.

Domestic Intelligence Division

INFORMATIVE NOTE

Date 8/31/72

Special Agents (SAs) C. Jordan Naylor and Earl M. Petersen of San Diego Office have been subpoenaed to appear in Superior Court, San Diego County, California, on 9/7/72 as witnesses for prosecution during trial of George Mitchell Hoover, a member of the white extremist, paramilitary Secret Army Organization (SAO). Charges against Hoover on shooting of Paula Tharp 1/6/72 were based on information developed by former Bureau extremist informant Howard Barry Godfrey who has been turned over to the San Diego Police Department and will testify.

Attached contains questions to be asked by prosecution and proposed answers regarding above SAs' relationship with former informant Godfrey and SA Petersen's recovery of the gun used in the shooting. Assistant U. S. Attorney, San Diego, to accompany SAs in court. Domestic Intelligence Division will obtain authority from Department of Justice and will coordinate with our Office of Legal Counsel.

WCP:aso
WCP

GCM/JGD

DJD
JAM

FEDERAL BUREAU OF INVESTIGATION
COMMUNICATIONS SECTION

AUG 31 1972

TELETYPE

Mr. Baker	_____
Mr. Bates	_____
Mr. Bishop	_____
Mr. Callahan	_____
Mr. Cleveland	_____
Mr. Conrad	_____
Mr. Dalbey	_____
Mr. Jenkins	_____
Mr. Marshall	_____
Mr. Miller, E.S.	_____
Mr. Ponder	_____
Mr. Soyars	_____
Mr. Walters	_____
Tele. Room	_____
Mr. Kinley	_____
Mr. Armstrong	_____
Ms. Herwig	_____
Mrs. Neenan	_____

LEM

NR 09 SD PLAIN

9:21PM NITEL 8-30-72 LLC

TO ACTING DIRECTOR (157-23577)

FROM SAN DIEGO (157-2815) 7P

Geo. Hoover

SECRET ARMY ORGANIZATION (SAO), EXTREMIST MATTERS.

RE SAN DIEGO AIRTEL AUGUST TWENTYEIGHT, LAST; AND
SAN DIEGO NITEL AUGUST TWENTYNINE, LAST.

ON AUGUST THIRTY, INSTANT, JOHN A HEWICKER, II,
DEPUTY DISTRICT ATTORNEY, SAN DIEGO COUNTY, MADE
AVAILABLE THE FOLLOWING QUESTIONS TO BE ASKED OF SA
C. JORDAN NAYLOR AND SA EARL M. PETERSEN DURING THE
TRIAL OF GEORGE MITCHELL HOOVER BEGINNING SEPTEMBER SEVEN,
NEXT:

PROSPECTIVE DIRECT EXAMINATION QUESTIONS FOR SA
EARL M. PETERSEN:

QUESTION ONE : NAME?

ANSWER: EARL M. PETERSEN.

QUESTION TWO: OCCUPATION?

ANSWER: SPECIAL AGENT OF THE FBI.

END PAGE ONE

REC-44

5-1 P. Miller

57-23577-49

17 SEP 7 1972

PERS. REC. UNIT

SD 157-2815

PAGE TWO

QUESTION THREE: HOW LONG EMPLOYED AS SPECIAL AGENT?

ANSWER: TWENTYONE YEARS.

QUESTIONS FOUR: ASSIGNED TO WHAT OFFICE?

ANSWER: SAN DIEGO.

QUESTION FIVE: HOW LONG ASSIGNED TO THE SAN DIEGO OFFICE?

ANSWER: FIVE YEARS.

QUESTION SIX: WHAT IS YOUR PARTICULAR AREA OF INVESTIGATION WITHIN THE OFFICE?

ANSWER: I INVESTIGATE VIOLATIONS OF THE LAWS OF THE UNITED STATES WHICH INCLUDES INVESTIGATIONS IN CONNECTION WITH THE INTERNAL SECURITY OF THE UNITED STATES AS DIRECTED.

QUESTION SEVEN: ARE YOU ACQUAINTED WITH AN INDIVIDUAL IDENTIFIED AS HOWARD GODFREY?

ANSWER: YES.

QUESTION EIGHT: HOW DID YOU BECOME ACQUAINTED WITH HIM?

ANSWER: I ACCOMPANIED FORMER SPECIAL AGENT STEVEN CHRISTENSEN WHEN HE MADE CONTACT WITH HIM ON ONE OCCASION ABOUT TWO AND ONE HALF YEARS AGO.

END PAGE TWO

SD 157-2815

PAGE THREE

QUESTION NINE: DID YOU EVER MAKE CONTACT WITH MR. GODFREY IN HIS CAPACITY AS AN INFORMANT?

ANSWER: YES, WHEN CHRISTENSEN WAS NOT AVAILABLE.

QUESTION TEN: ON JULY FIFTH OF THIS YEAR DID YOU ASSIST IN RECOVERING POSSESSION OF A WEAPON ALLEGEDLY USED IN THE SHOOTING OF PAULA THARP?

ANSWER: YES.

QUESTION ELEVEN: DESCRIBE THE CIRCUMSTANCES OF YOUR PARTICIPATION IN THIS RECOVERY.

ANSWER: ON OR ABOUT JULY FIFTH DURING A PRETRIAL CONFERENCE IN THIS MATTER IT BECAME APPARENT THAT POSSIBLY STEVEN CHRISTENSEN MIGHT HAVE POSSESSION OF THIS WEAPON. I MADE A TELEPHONE CALL TO CHRISTENSEN IN LOS ANGELES AND ASKED HIM IF HE HAD THE WEAPON. HE STATED THAT HE DID. I THEN ASKED HIM IF HE WISHED TO TURN THE WEAPON OVER TO THE SAN DIEGO POLICE DEPARTMENT FOR EVIDENCE IN A TRIAL INVOLVING THE SHOOTING OF PAULA THARP. HE ANSWERED THE HE DID. HE ADVISED ME THAT THE WEAPON WAS UNDER A COUCH IN HIS HOME AND ADVISED ME WHERE I COULD OBTAIN A KEY WITH WHICH TO ENTER THE HOUSE. HE AUTHORIZED ME TO GO TO THE HOUSE,
END PAGE THREE

PAGE FOUR

SD 157-2815

ENTER, AND ALLOW DETECTIVE RUBIEN BRANDON TO TAKE POSSESSION OF THE GUN AS EVIDENCE. AFTER THE TELEPHONE CONVERSATION, DETECTIVE BRANDON ACCOMPANIED ME TO CHRISTENSEN'S HOME WHERE WE FOUND THE WEAPON AS DESCRIBED BY CHRISTENSEN. AT THAT TIME DETECTIVE BRANDON TOOK POSSESSION OF THE WEAPON.

QUESTION TWELVE: WHAT, IF ANYTHING, WAS DONE WITH THIS WEAPON ON JULY FIFTH?

ANSWER: DETECTIVE BRANDON TOOK THE WEAPON WITH HIM.

PROSPECTIVE REBUTAL EXAMINATION QUESTIONS FOR

SA C. JORDAN NAYLOR:

QUESTION ONE: NAME?

ANSWER: C. JORDAN NAYLOR.

QUESTION TWO: OCCUPATION?

ANSWER: SPECIAL AGENT - FBI.

QUESTION THREE: HOW LONG EMPLOYED AS SPECIAL AGENT?

ANSWER: EIGHTEEN YEARS.

END PAGE FOUR

PAGE FIVE

SD 157-1815

QUESTION FOUR: ASSIGNED TO WHAT OFFICE?

ANSWER: SAN DIEGO.

QUESTION FIVE HOW LONG BEEN ASSIGNED TO THE SAN DIEGO
OFFICE?

ANSWER: NINE YEARS.

QUESTION SIX: AS PART OF YOUR DUTIES AN AN FBI AGENT
DID YOU DEVELOP HOWARD GODFREY INTO AN INFORMANT FOR THE FBI?

ANSWER: YES.

QUESTION SEVEN: HOW WERE YOU FIRST INTRODUCED TO MR.
GODFREY?

ANSWER: THROUGH A MUTUAL FRIEND.

QUESTION EIGHT: WHEN?

ANSWER: FEBRUARY, NINETEEN SIXTY SEVEN.

QUESTION NINE: WHAT WAS YOUR DUTY ASSIGNMENT AT THAT
TIME?

ANSWER: GENERAL CRIMINAL MATTERS INCLUDING THEFTS OF
GOVERNMENT PROPERTY AND ITSP.

END PAGE FIVE

PAGE SIX

SD 157-2815

QUESTION TEN: HOW OFTEN DID YOU HAVE CONTACT WITH MR. GODFREY?

ANSWER: ON AVERAGE OF ONCE A WEEK.

QUESTION ELEVEN: HOW DID YOU AND HE CONTACT ONE ANOTHER?

ANSWER: IN PERSON AND BY TELEPHONE.

QUESTION TWELVE: WAS GODFREY A PAID INFORMANT?

ANSWER: YES.

QUESTION THIRTEEN: WHAT WAS THE BASIS FOR HIS PAYMENT?

ANSWER: TO REIMBURSE FOR HIS EXPENDITURES *and services.*

QUESTION FOURTEEN: HOW FREQUENTLY AND IN WHAT AMOUNT WAS HE PAID DURING THE TIME HE WAS AN INFORMANT FOR YOU?

ANSWER: DURING THE PERIOD MARCH, NINETEEN SIXTY SEVEN THROUGH DECEMBER, NINETEEN SIXTY EIGHT, I PAID MR. GODFREY A TOTAL OF FOUR HUNDRED DOLLARS FOR SERVICES AND EXPENSES.

QUESTION FIFTEEN: DID YOU AT SOME TIME TURN MR. GODFREY OVER TO SOME OTHER AGENT AS AN INFORMANT?

ANSWER: YES.

END PAGE SIX

PAGE SEVEN

SD 157-2815

QUESTION SIXTEEN: WHEN AND WHY?

ANSWER: IN NINETEEN SIXTYEIGHT, INFORMATION HE WAS ABLE TO REPORT ON WAS NOT OF A COMPATIBLE NATURE WITH MY ASSIGNMENT.

AUSA ROBERT H. FILSINGER OR ANOTHER AUSA DESIGNATED BY HIM WILL BE IN COURT DURING THE TESTIMONY OF SPECIAL AGENTS NAYLOR AND PETERSEN AND FORMER SA STEVEN L. CHRISTENSEN TO PROTECT THE INTEREST OF THE GOVERNMENT.

THE BUREAU IS REQUESTED TO OBTAIN AUTHORITY OF THE ATTORNEY GENERAL FOR TESTIMONY OF SAS NAYLOR AND PETERSEN TO THE QUESTIONS AND ANSWER AS STATED ABOVE.

-P-

END

ACK FOR SIX TEL LNG FBI WA CLR

6 P — MR. TRAINOR
ROOM 712-A 9&D

FBI

Date: 8/18/72

Transmit the following in _____
(Type in plaintext or code)

Via AIRTEL AIRMAIL - REGISTERED
(Priority)

TO: ACTING DIRECTOR, FBI (157-23577)

FROM: SAC, SAN DIEGO (157-2815) (P)

SECRET ARMY ORGANIZATION (SAO)
EXTREMIST MATTERS

ReBulet to San Diego dated 8/7/72.

Enclosed for the Bureau are eight (8) copies of an LHM regarding captioned subject matter.

A copy of this LHM has been disseminated to Secret Service, San Diego, because the SAO presents a potential for violence.

Detective RUBEN BRANDON, Intelligence Division, San Diego Police Department, made available the information from the San Diego Police Department contained in the enclosed LHM.

The records of NCIC were negative on the Thompson Submachine Gun, serial number 20180132, mentioned in enclosed LHM, and separate inquiry is being conducted to determine if this weapon was stolen, and NCIC has been checked with negative results to date regarding other weapons mentioned in this communication.

The San Diego Office will follow local prosecutive action regarding the SAO and its members and keep the Bureau apprised of any developments.

- ② Bureau (Encs. 8) (M-RM)
- 3- San Diego
 - (2 - 157-2815)
 - (1 - 170-286)

ENCLOSURE
REC-38

157-23577-48

EX-116 AUG 24 1972

58 SEP 27 1972
(5)

Deleted Copy Sent Douglas Porter
by Letter 7-175 en. 1, 5, 29, 32, 34, 36, 37
Per FOIA Request 41, 42, 51, 52, 54, 57, 59, 81-83

EXT. INT. SEC.

Approved: _____ Sent _____ M Per _____
Special Agent in Charge

100 1062
100 ATFD
100 ISD
100 CRD
8/25/72
WCP/mgr

gc
FIR
FRANZ
SUGGESTION

100-23577-48

SD 157-2815

Primary portions of the evidence in the cases in this LHM are currently being used for presentation of the cases at the San Diego County Grand Jury, and San Diego will remain in contact with the police department for additional detailed information regarding their investigations, arrests, and information regarding the evidence obtained.

The San Diego Office has pending investigations on the following individuals mentioned in the enclosed LHM.

WILLIAM FRANCIS YAKOPEC
SD 157-1820

GEORGE MITCHELL HOOVER
SD 157-3017

RICHARD FLEURY
SD 157-3290

GENEVIEVE FLEURY
SD 157-3289

JERRY LYNN DAVIS
SD 157-3001

ROBERT MAYER, JR.
SD 157-2931

HOWARD FRANCIS CLARK
SD 157-2546

VAHL BOYLE
SD 157-3388

THOMAS LEE FORREST
SD 157-2177



UNITED STATES DEPARTMENT OF JUSTICE

FEDERAL BUREAU OF INVESTIGATION

In Reply, Please Refer to
File No.

San Diego, California

August 18, 1972

SECRET ARMY ORGANIZATION (SAO)

The Secret Army Organization (SAO) is an anti-communist, paramilitary organization formed in 1971 in San Diego, California. It intends to conduct intelligence-type operations and to offer training in urban guerrilla warfare to be used against "Left-Wing groups" and suspected enemies of the United States.

The above description of the SAO was furnished by Howard Barry Godfrey, a San Diego City fireman, who during June and July, 1972, testified before the San Diego County Grand Jury regarding his knowledge of the activities and members of the SAO. Godfrey testified that over the past year, he has served as an officer and was a member of the SAO in San Diego. He also testified that for the last five years he has acted as an informant for the Federal Bureau of Investigation (FBI).

It is noted that Howard Barry Godfrey, for a number of years, voluntarily furnished the FBI information regarding the identities and activities of extremist groups in the San Diego area. His information has been reliable and as an interested citizen he volunteered his knowledge and services to

This document contains neither recommendations nor conclusions of the FBI. It is the property of the FBI and is loaned to your agency; it and its contents are not to be distributed outside your agency.

ENCLOSURE

157-23577-48

SECRET ARMY ORGANIZATION (SAO)

local law enforcement agencies which culminated in his appearance and testimony before the San Diego County Grand Jury in June and July, 1972.

Information furnished by Godfrey to the FBI, San Diego Police Department, and the San Diego Grand Jury resulted in the search warrants, arrests, and confiscation of weapons and SAO literature described in this communication. The information regarding the warrants, arrests and evidence obtained was furnished by the San Diego Police Department.

SECRET ARMY ORGANIZATION (SAO)

WILLIAM FRANCIS YAKOPEC

On June 19, 1972, an unidentified individual planted a bomb in the Guild Movie Theater, an adult movie theater specializing in "X" rated films, located at 3827 Fifth Avenue, San Diego, California. The bomb exploded causing extensive damage. Flying debris narrowly missed hurting and/or killing patrons.

On June 20, 1972, Godfrey identified William Francis Yakopec, a member of the SAO, as the person who did the bombing. Godfrey said this was an individual act on Yakopec's part caused by his dislike for pornography. Yakopec told Godfrey the bomb was fashioned from one-third pound of HPD primer with a blasting cap, fuse, and a pull-type igniter. As a result of this information, the San Diego Police Department secured a search warrant for the residence of Yakopec. After the search was executed on June 26, 1972, Yakopec was arrested for violation of the California Penal Code dealing with possession and improper storage of gunpowder in excess of twenty pounds without a license and for attempted murder in connection with the bombing of the Guild Movie Theater.

Yakopec was indicted on July 12, 1972, after a true bill was returned by the San Diego County Grand Jury and is presently incarcerated in the San Diego County Jail. No trial date has yet been set.

The following is a summary of the evidence seized at the home of William Francis Yakopec, 722 Graves Avenue, El Cajon, California, on June 26, 1972, by the San Diego Police Department:

One (1) fully loaded Winchester model 12 gauge shotgun, serial number C 65537. This weapon was found in the living room on top of a coffee table.

Fuse igniters found underneath the floor where loose boards were secured by the weight of the bed in the east bedroom.

One (1) loaded military .30 caliber carbine located adjacent to the rear door in kitchen area.

SECRET ARMY ORGANIZATION (SAO)

One (1) unloaded 30.06 model 1903 Springfield rifle, serial number 1375179, located in gun rack mounted on wall in the east bedroom.

One (1) military field manual titled, "Explosives FM #5-25," found in closet of east bedroom.

One (1) cardboard box containing assorted ammunition and black powder found within a trailer adjacent to the residence.

Assorted SAO and Minutemen literature and papers located in various parts of the residence and adjacent trailer.

The Minutemen (MM), referred to above, is a paramilitary group organized in June, 1960, by Robert D. De Pugh in Norborne, Missouri, as a resistance to the spread of communism in the United States by use of guerrilla tactics. De Pugh is currently incarcerated in a Federal penitentiary for violation of the Federal Firearms Act.

The Patriotic Party has been the political arm of the Minutemen.

SECRET ARMY ORGANIZATION (SAO)

GEORGE MITCHELL HOOVER

On January 6, 1972, a bullet struck the residence of Peter Bohmer, 5155 Muir, San Diego, California. The bullet penetrated the house and according to the San Diego Police Department, a guest in the house, Paula Tharp, was struck in the elbow by the bullet.

The "San Diego Union," a daily San Diego, California, newspaper, issue of August 6, 1972, contains an article describing Peter Bohmer as a former California State University, San Diego, economics professor known for his liberal views and activities.

Godfrey advised in January, 1972, that he and George Mitchell Hoover, a member of the SAO, on January 6, 1972, were conducting a surveillance of the Peter Bohmer residence at the request of Jerry Lynn Davis, leader of the SAO, for the purpose of obtaining intelligence information. Prior to leaving the area in Godfrey's car, Hoover pointed a pistol out the window and fired two shots at the house.

Godfrey testified before the San Diego County Grand Jury that he witnessed Hoover fire two shots at the house at 5155 Muir Street on the night of January 6, 1972. He said the nine millimeter Polish Radom pistol jammed before Hoover could fire a third shot.

The San Diego Police Department, on the basis of Godfrey's information, filed and executed a search warrant for Hoover's residence, 8721½ Magnolia Street, Santee, California, on June 26, 1972. Hoover was arrested and charged with attempted murder and possession of a "Billy" club.

Hoover was indicted after a true bill was returned by the San Diego County Grand Jury and is presently incarcerated in the San Diego County Jail, with trial set for September 7, 1972.

The following is a summary of the evidence seized at the home of Hoover, 8721½ Magnolia Street, Santee, California:

SECRET ARMY ORGANIZATION (SAO)

One (1) Hi-Standard .22 caliber Derringer loaded with two rounds of .22 caliber ammunition, found in pants' pocket of blue levis next to bed.

Chrome firing mechanism, appearing to be the type used to discharge shotgun shells by hand, found on shelf.

Pistol Pyrotechnic black flare gun loaded with one flare, on top of bookcase in main room.

One (1) black 16-inch "Billy" club found on shelf in bedroom.

Miscellaneous rounds of ammunition in various calibers, magazines for automatic weapons, and material for reloading ammunition, found on shelves in bedroom and in back room.

SAO literature and manuals on military equipment found in various locations in the house.

Seven (7) blue plastic bottles marked with the brand name "Xerox Toner" containing a black powder substance believed to be black gunpowder.

One (1) one-pound coffee can marked 45 ACP containing a black powder substance believed to be gunpowder.

SECRET ARMY ORGANIZATION (SAO)

RICHARD FLEURY;
GENEVIEVE FLEURY

MR. & MRS. - Based on information from Godfrey in June, 1972, that Richard Fleury was a member of the SAO and that he and his wife, Genevieve Fleury, are both personal associates of William Francis Yakopec, the San Diego Police Department obtained search warrants for residence at 1544 Harbinson Canyon Road, El Cajon, California, which were executed on June 26, 1972.

As a result of the search, both Richard and Genevieve Fleury were arrested and charged with unlawful possession of explosives.

Richard and Genevieve Fleury were both indicted on the above charges after a true bill was returned on each of them on July 12, 1972, by the San Diego County Grand Jury. The trial date for the Fleurys has not been set.

The following is a summary of the evidence seized by the San Diego Police Department at the Fleury residence, 1544 Harbinson Canyon Road, El Cajon, California:

One (1) nine millimeter Luger, serial number 4243 found inside third drawer, right side of bedroom dresser in southwest corner of bedroom.

One (1) .22 Liberty Revolver, serial number IC81001, found inside fourth drawer, right side of bedroom dresser in southwest corner of bedroom.

One (1) 12 gauge Savage over and under, serial number LPP18, found inside gun cabinet on north wall of den.

One (1) .22 Shippert Rifle, no serial number, found inside gun cabinet on north wall of den.

SECRET ARMY ORGANIZATION (SAO)

One (1) .410 Newhaven Shotgun, serial number 410245 found inside gun cabinet on north wall of den.

One (1) .410 Newhaven Shotgun, serial number 414947 found inside gun cabinet on north wall of den.

One (1) 7.62 Japanese Rifle, serial number 94528 found inside gun cabinet on north wall of den.

One (1) .22 Winchester Rifle, no serial number, found on gun rack on south wall of living room.

One (1) .22 Savage Rifle, serial number 126049 found on gun rack on south wall of living room.

The following items of evidence, because of their dangerous capabilities, were separated from the main body of evidence and transported and impounded at the Police Pistol Range:

One (1) fourteen inch by twenty-four inch by ten inch cardboard box containing the following:

One (1) pink 12 pound can labeled "Hercules Red Dot Smokeless Shotgun Powder"

One (1) pink 3 pound can labeled "Hercules Red Dot Smokeless Shotgun Powder"

Twenty-two (22) blue plastic bottles marked with brand name "Xerox Toner" containing a black powder substance believed to be black gunpowder.

Three (3) cans labeled "Hercules Smokeless 2400 Rifle Powder"

Two (2) cans labeled "Hercules Smokeless Bullseye Pistol Powder"

SECRET ARMY ORGANIZATION (SAO)

One (1) can labeled "Hercules
Smokeless Unique Rifle, Pistol,
and Shotgun Powder"

One (1) can labeled "AL-7 Smoke-
less Shotgun Powder"

One (1) can labeled "Hercules
Smokeless Powder 2400 Rifle Powder"

One (1) can labeled "Dupont IMR-4350
Improved Military Rifle Powder".

One (1) six inch cylindrical cardboard canister,
11½ inches long, labeled "Hercules Green Dot
Smokeless Shotgun Powder," approximately half
full.

Other items located were:

Numerous SAO stickers found in a brown
wallet in the southwest bedroom.

White plastic containing numerous .22
caliber rounds found on the bedroom
dresser in southwest bedroom.

One paper bag containing ammunition
found on the top closet shelf of the
southeast bedroom.

Three (3) bayonets and one Luger pistol
holder found in a bottom drawer inside
closet in the southwest bedroom.

Fourteen (14) boxes of various caliber
ammunition, three bayonets, two German
medals, one Nazi flag, all found inside
a cabinet on the west wall of the den.

Eight (8) cloth ammunition bandoliers
containing approximately one thousand
rounds of .30 caliber ammunition found
inside a wooden box inside a cabinet on
the west wall of den.

SECRET ARMY ORGANIZATION (SAO)

JERRY LYNN DAVIS

In April and May, 1972, Godfrey advised that Jerry Lynn Davis, 2393 Washington, Spring Valley, California, is the leader of the SAO in San Diego and has been in possession of explosives in the past.

On July 2, 1972, based on information from Godfrey, the San Diego Police Department arrested Jerry Lynn Davis and charged him with possession of explosives and receiving stolen property.

On July 18, 1972, the San Diego Grand Jury returned a true bill on Davis and he was indicted on above charges. No trial date has been set.

SECRET ARMY ORGANIZATION (SAO)

ROBERT MAYER, JR.

On January 14, 1972, Godfrey identified Robert Mayer, Jr., 2204 Montclair Street, San Diego, California, as a member of the SAO. During June, 1972, he furnished this information to the San Diego Police Department.

On July 12, 1972, Mayer appeared before the San Diego County Grand Jury and denied membership in the SAO.

The San Diego Police Department advised that Mayer was subsequently arrested on July 24, 1972, at his residence, 2204 Montclair, San Diego, California, in execution of a Superior Court warrant at San Diego, California, charging him with perjury before the San Diego County Grand Jury. A leaflet entitled "Formulas for Ammonium Nitrate" was found in his garage by the arresting officers.

SECRET ARMY ORGANIZATION (SAO)

HOWARD FRANCIS CLARK

~~Francis~~ Godfrey advised on April 11, 1971, that Howard Francis Clark had been accepted as a member of the SAO.

On April 20, 1972, Godfrey received information that Clark was in possession of numerous weapons and that in January, 1972, had stated that he was in a position to acquire all the TNT and C-4 plastic explosives he wanted.

Based on additional investigation and the information from Godfrey, the San Diego Police Department, accompanied by officers from the San Diego County Sheriff's Office on July 23, 1972, executed a search warrant on the residence of Howard Francis Clark, 1080 Sixth Street, Ramona, California.

Clark was arrested by the San Diego Police Department and charged with possession of explosives, possession of an illegal tear gas gun, and receiving stolen property after a search of his residence produced thousands of rounds of military ammunition, detonated land mines, assorted mortar rounds, numerous rifles and handguns, and SAO literature. Clark admitted belonging to the SAO.

On August 9, 1972, the San Diego County Grand Jury returned a true bill against Clark and he was indicted on the above charges. A trial date has not been set.

SECRET ARMY ORGANIZATION (SAO)

VAHL BOYLE

Calif
Godfrey advised on ^{MRS} March 13, 1972, that on March 12, 1972, Bettie Haughton, wife of Troy Haughton, former local leader of the MM who disappeared in 1967, said that a large quantity of explosives are supposed to be buried under the house of Vahl Boyle, Troy Haughton's mother.

On July 21, 1972, based on the above information from Godfrey, the San Diego Police Department obtained and executed a search warrant on the residence of Vahl Boyle, 4443 Upland Street, La Mesa, California. A quantity of military drugs and medical supplies, explosive paraphernalia, and MM literature was located buried under the residence. The material was seized but Boyle was not arrested.

SECRET ARMY ORGANIZATION (SAO)

THOMAS LEE FORREST

Godfrey advised on March 5, 1971, that Thomas Lee Forrest associates with known members of the MM organization and is involved in purchasing and selling automatic weapons and possibly in the manufacture of these weapons.

On January 20, 1972, Godfrey advised he had observed a number of boxes containing M-14 rifle actions at Forrest's place of business. *Not if*

Based on Godfrey's information and investigation by the San Diego Police Department, Forrest was arrested by agents of the United States Alcohol, Tobacco, and Firearms Division on July 24, 1972, and charged with the sale of several illegal automatic weapon conversion kits. Forrest faces Federal charges as a result of this arrest.

SECRET ARMY ORGANIZATION (SAO)

THOMPSON SUBMACHINE GUN

On July 18, 1972, the San Diego Police Department advised that a confidential source told them that approximately six years ago he found a Thompson Submachine Gun, caliber .45, on the front porch of his residence. He admitted that Troy Haughton, former leader of the MM, presumably left it for him on his front porch to keep.

On July 24, 1972, the same source escorted by officers of the San Diego Police Department took them to an unmarked hiding place near Alpine, California, which is located in the mountains east of San Diego. Using a metal detector, they located and unearthed one Thompson Submachine Gun, caliber .45, and which bore serial number A0180132, which was wrapped and sealed in heavy paper and encased in grease.

The following page shows a photograph of the submachine gun, and a second photograph of the wrapper that encased the machine gun:

SECRET ARMY ORGANIZATION (SAO)

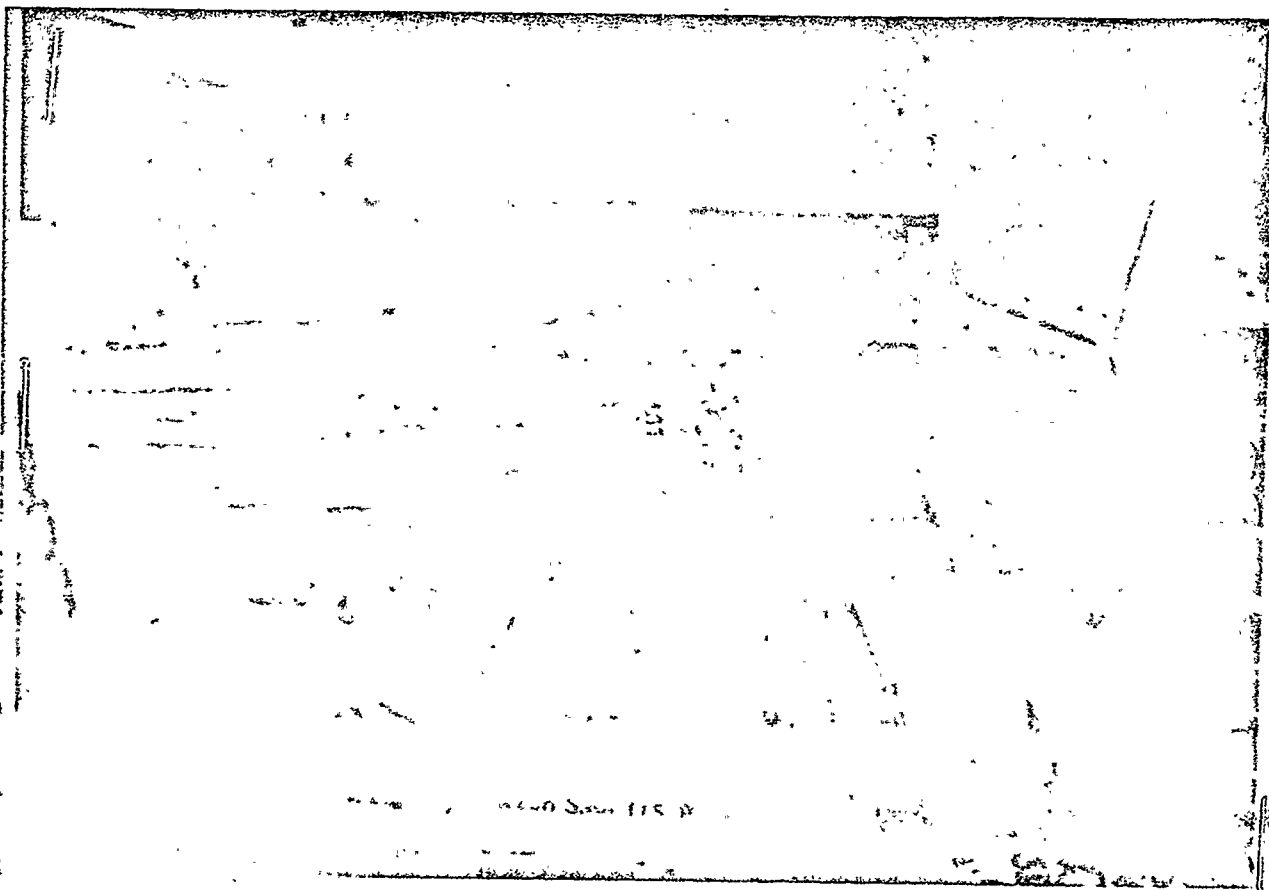

SECRET ARMY ORGANIZATION (SAO)



SECRET ARMY ORGANIZATION (SAO)

ARMS CACHE - CUYAMACA PARK

Godfrey advised the FBI on several occasions during 1972 and the San Diego Police Department during June, 1972, that the SAO has in the past made several cache of weapons and explosives in the San Diego area, exact locations unknown.

The San Diego Police Department has advised that a private citizen, in July, 1972, by accident, located a cache of weapons in Cuyamaca State Park which is located in San Diego County in the mountains east of San Diego proper. On July 24, 1972, the San Diego County Sheriff's Office seized and recovered this cache which included a flame thrower, weapons and explosives. (Photographs of this cache are shown on pages 19 through 27.)

Godfrey has advised the San Diego Police Department that members of the SAO are previously known to be in possession of the same type of explosives as found in above cache and that the primer fuses in the cache are of the type used in the bombing of the Guild Movie Theater in San Diego, but he cannot pinpoint any of the cache seized as identical with that previously in possession of SAO members.

SECRET ARMY ORGANIZATION (SAO)

ARMS CACHE - CUYMACA PARK

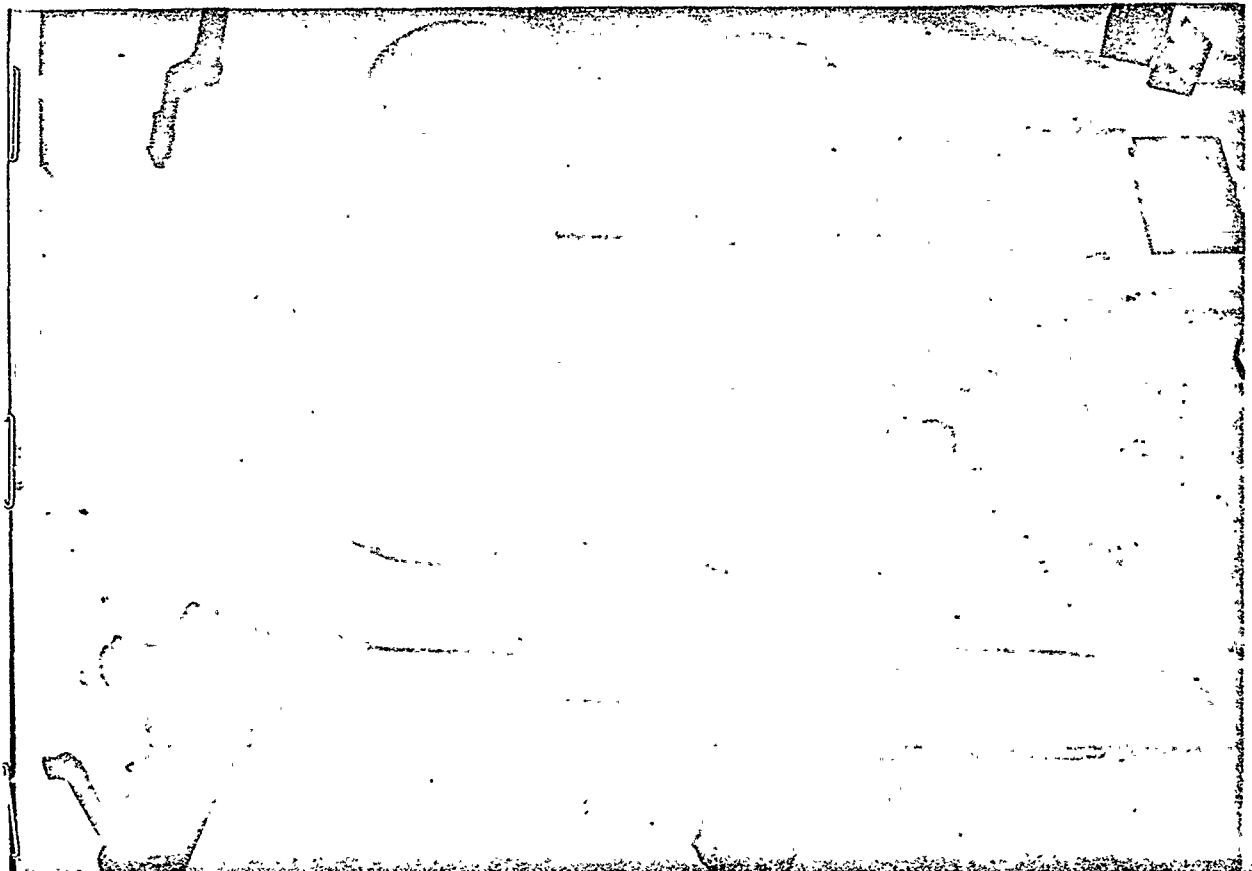

ABOVE PHOTOGRAPH SHOWS TWO FLAME THROWER TANKS
AND A FLAME THROWER GUN.

SECRET ARMY ORGANIZATION (SAO)

ARMS CACHE - CUYAMACA PARK

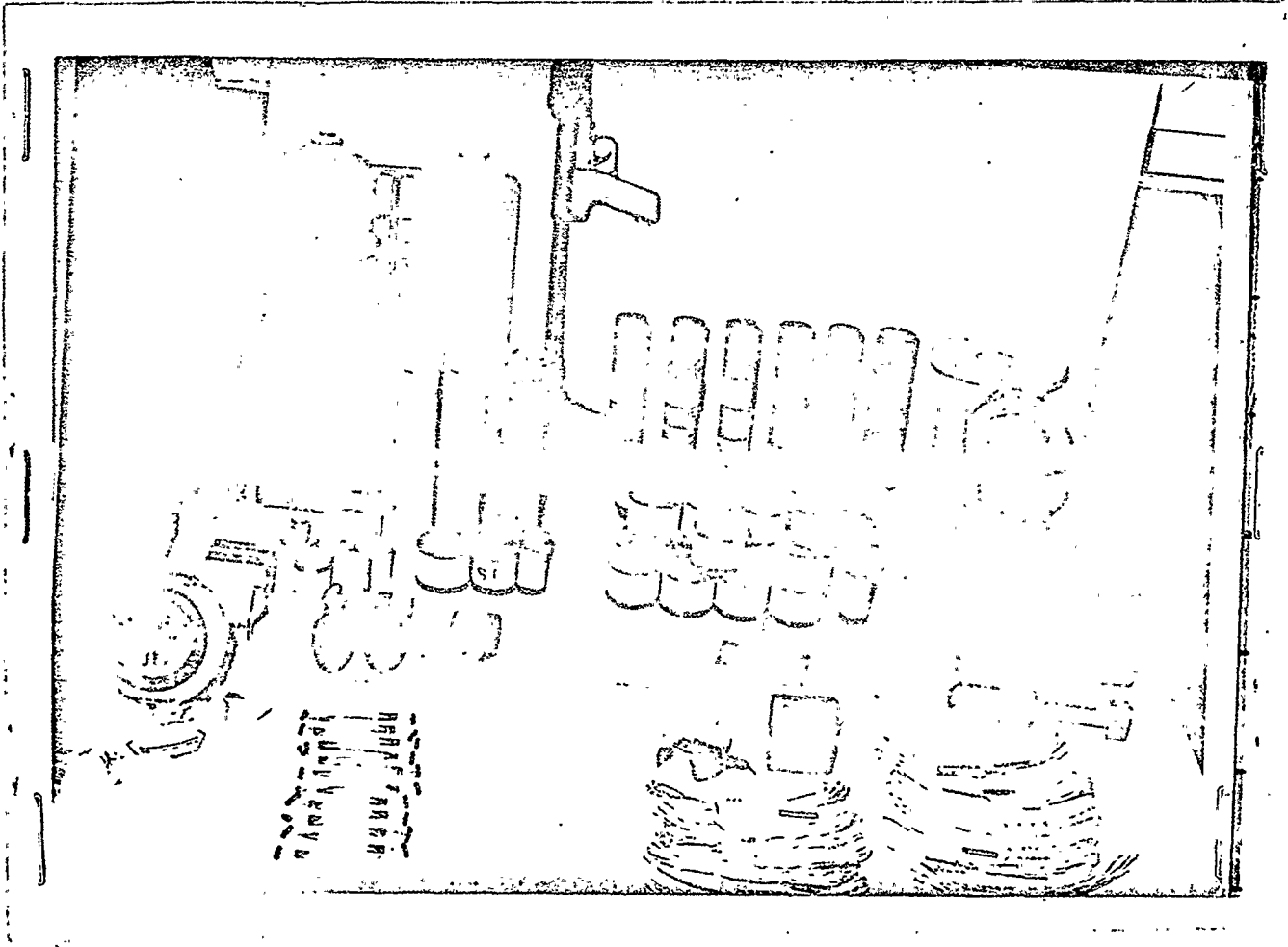

COMPOSIT PHOTOGRAPH SHOWING VARIOUS TYPES OF EXPLOSIVES LOCATED IN THE CACHE, INCLUDING A FLAME THROWER, HAND GRENADES, SAFETY FUSE, AND HDP-1 PRIMER.

SECRET ARMY ORGANIZATION (SAO)

ARMS CACHE - CUYAMACA PARK

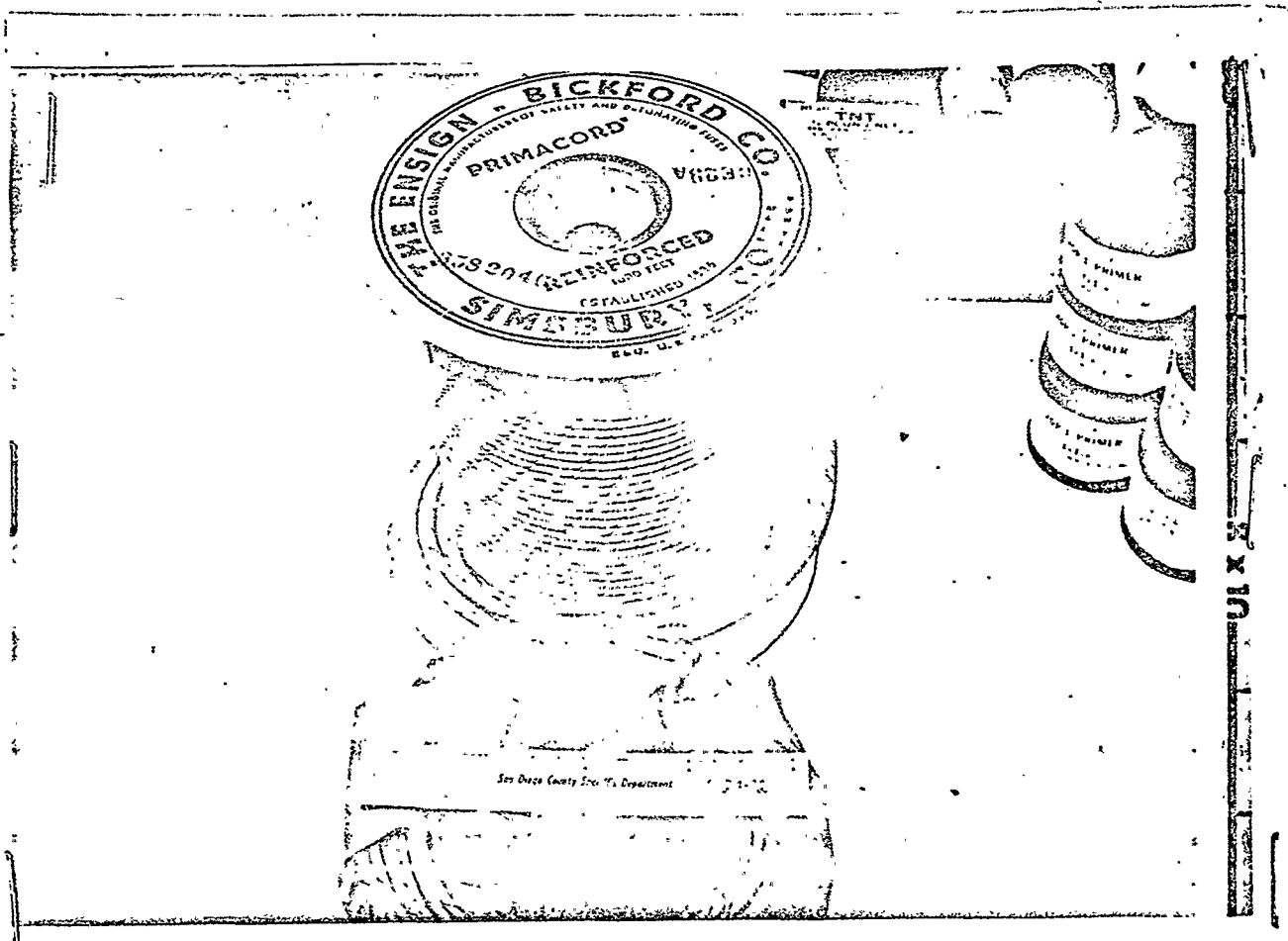

IN THE FOREGROUND, A PARTIAL ROLL OF PRIMACORD
USED IN DETONATING EXPLOSIVES.

SECRET ARMY ORGANIZATION (SAO)

ARMS CACHE - CUYAMACA PARK

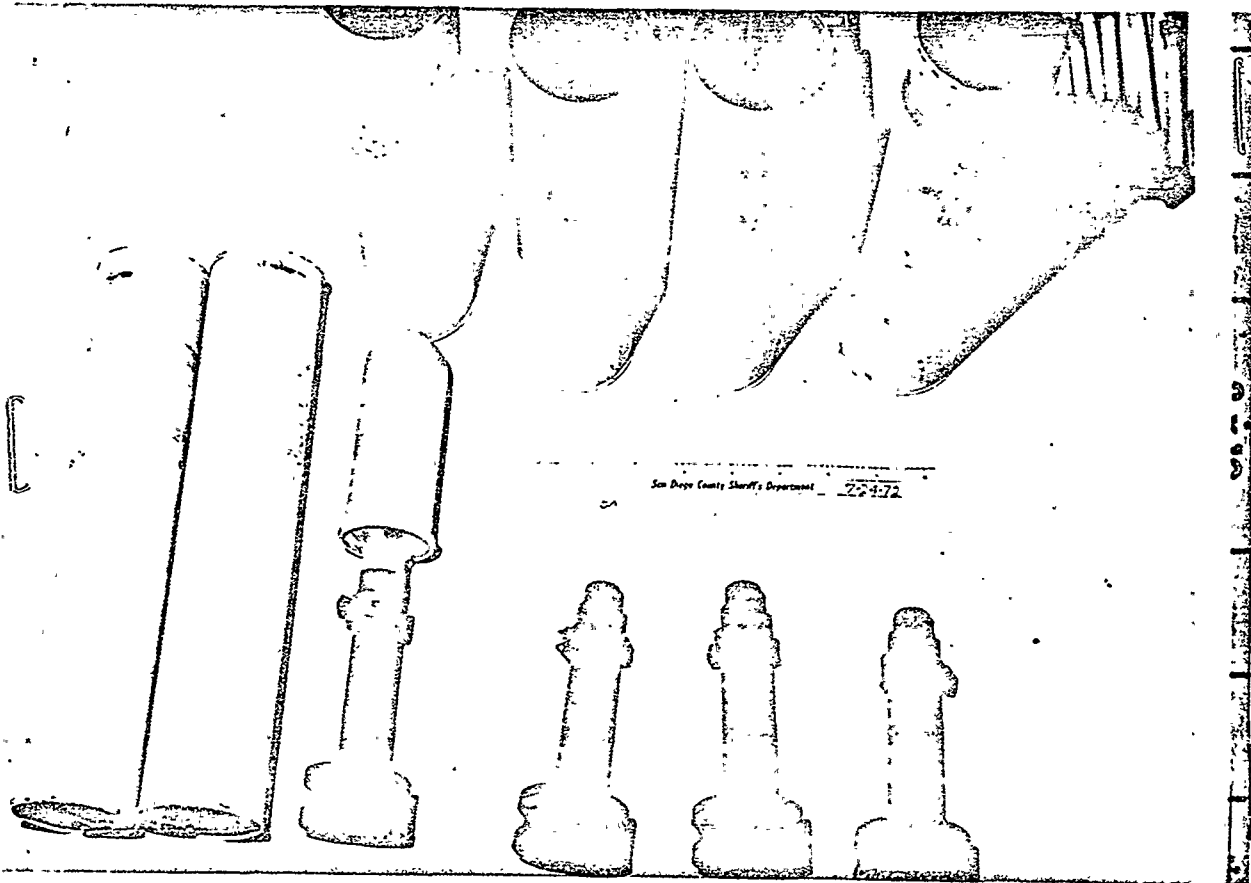

MILITARY-TYPE SMOKE GRENADES TO BE PROPELLED
FROM A RIFLE.

ARMS CACHE - CUYAMACA PARK

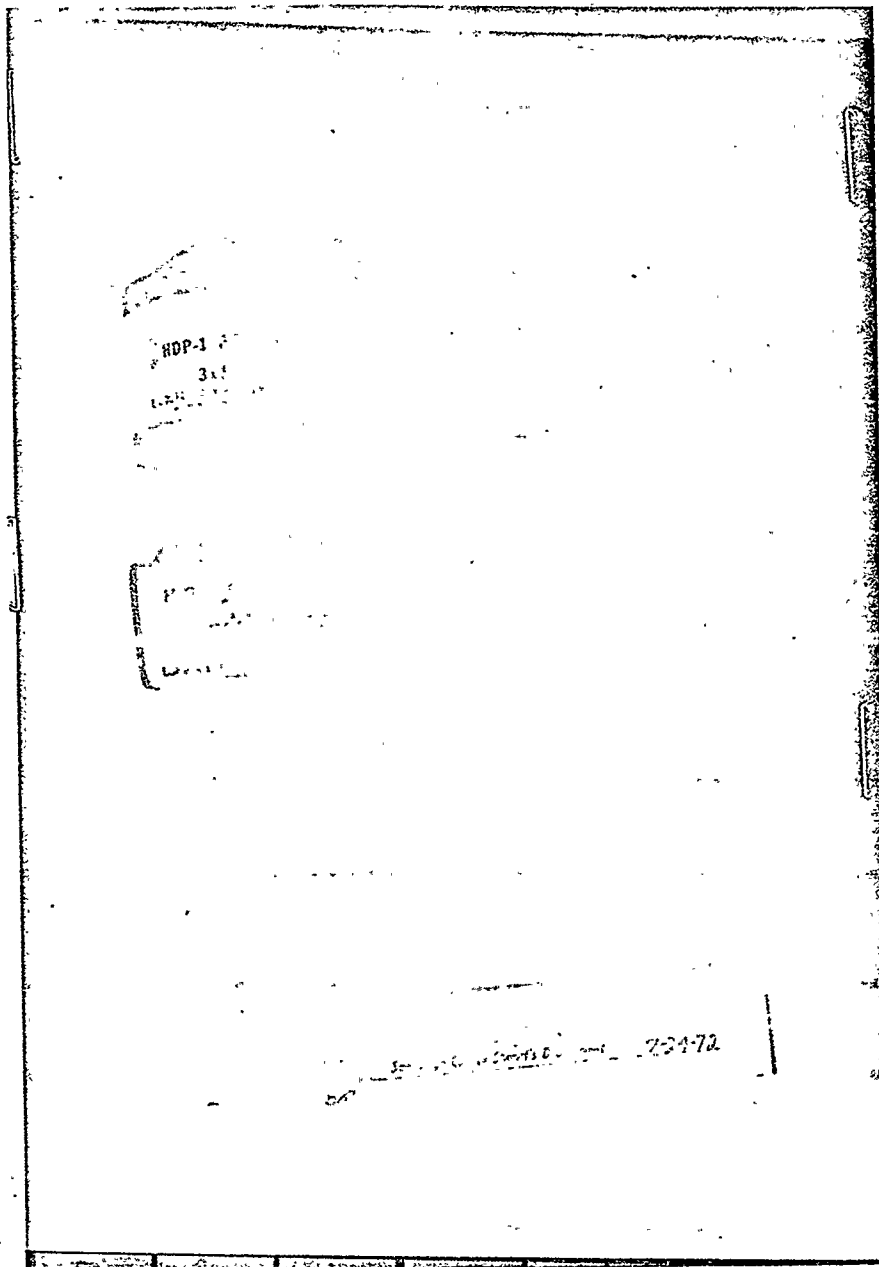

TOP OF PHOTOGRAPH SHOWS PRIMER. IN THE CENTER OF PHOTOGRAPH IS ONE-HALF POUND OF TNT AND OTHER EXPLOSIVES.

SECRET ARMY ORGANIZATION (SAO)

ARMS CACHE - CUYAMACA PARK

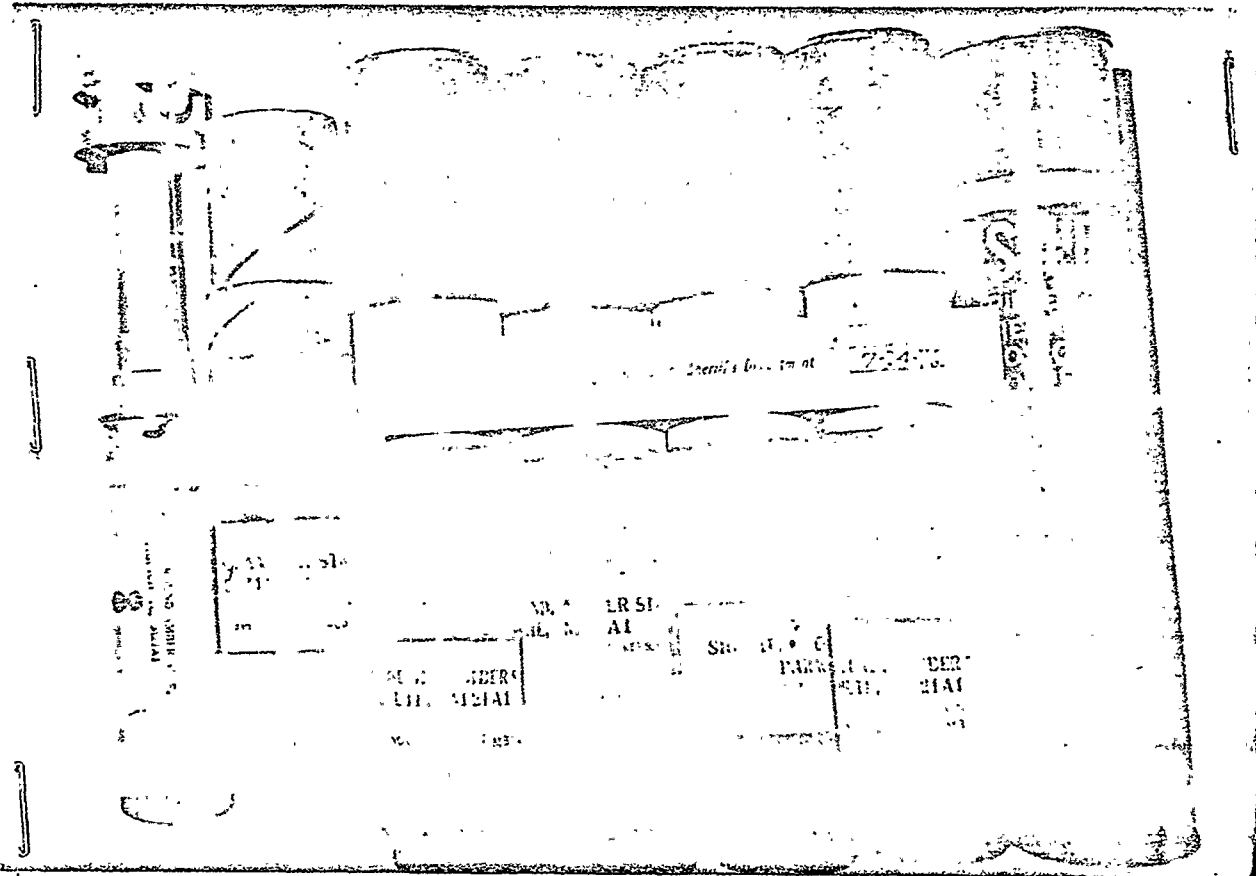

PROJECTILE MILITARY-TYPE FLARES.

SECRET ARMY ORGANIZATION (SAO)

ARMS CACHE - CUYAMACA PARK

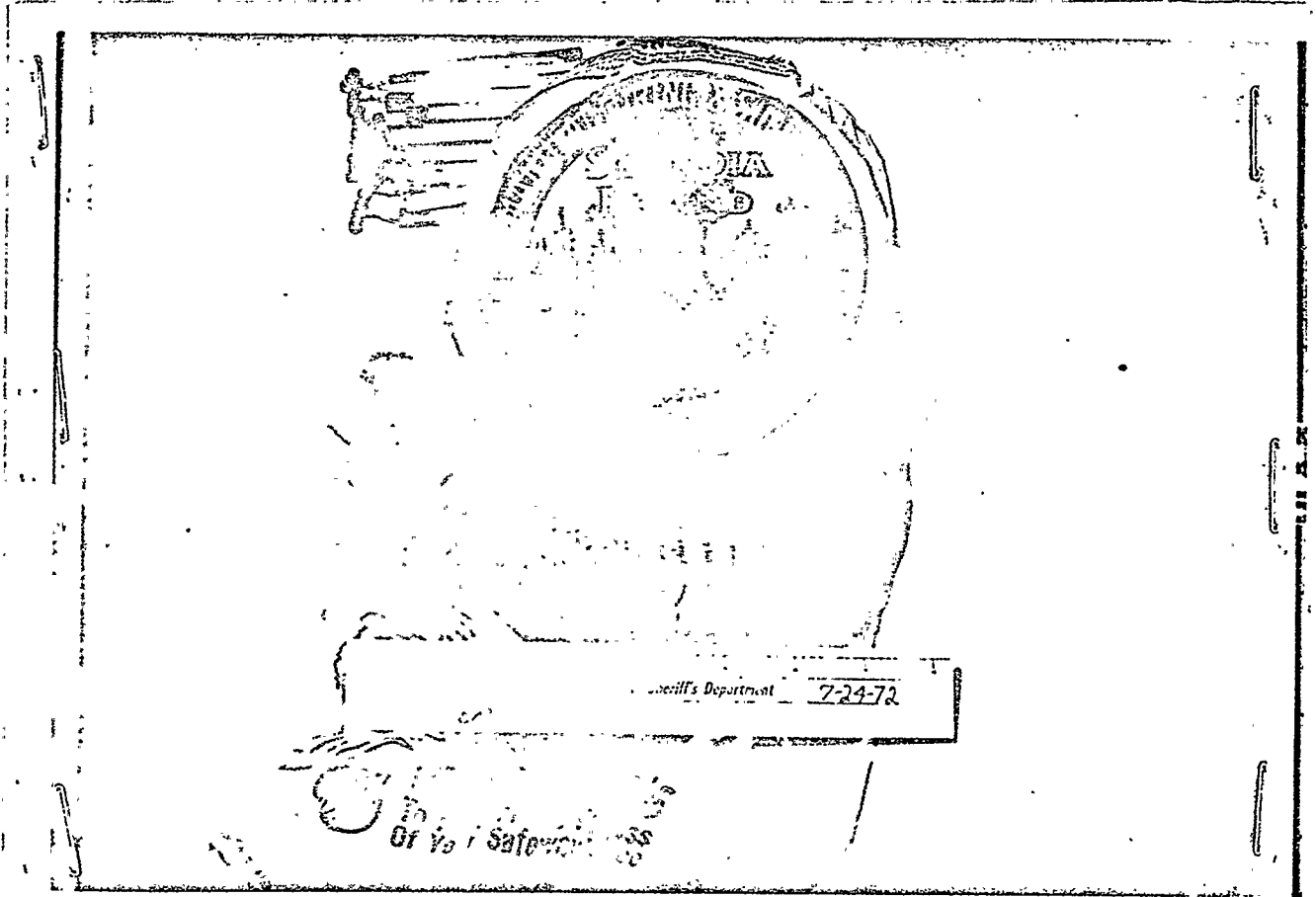

IN THE FOREGROUND, WATERPROOF SAFETY FUSE,
AND IN THE BACKGROUND, A NUMBER OF FUSE
IGNITERS.

SECRET ARMY ORGANIZATION (SAO)

ARMS CACHE - CUYAMACA PARK

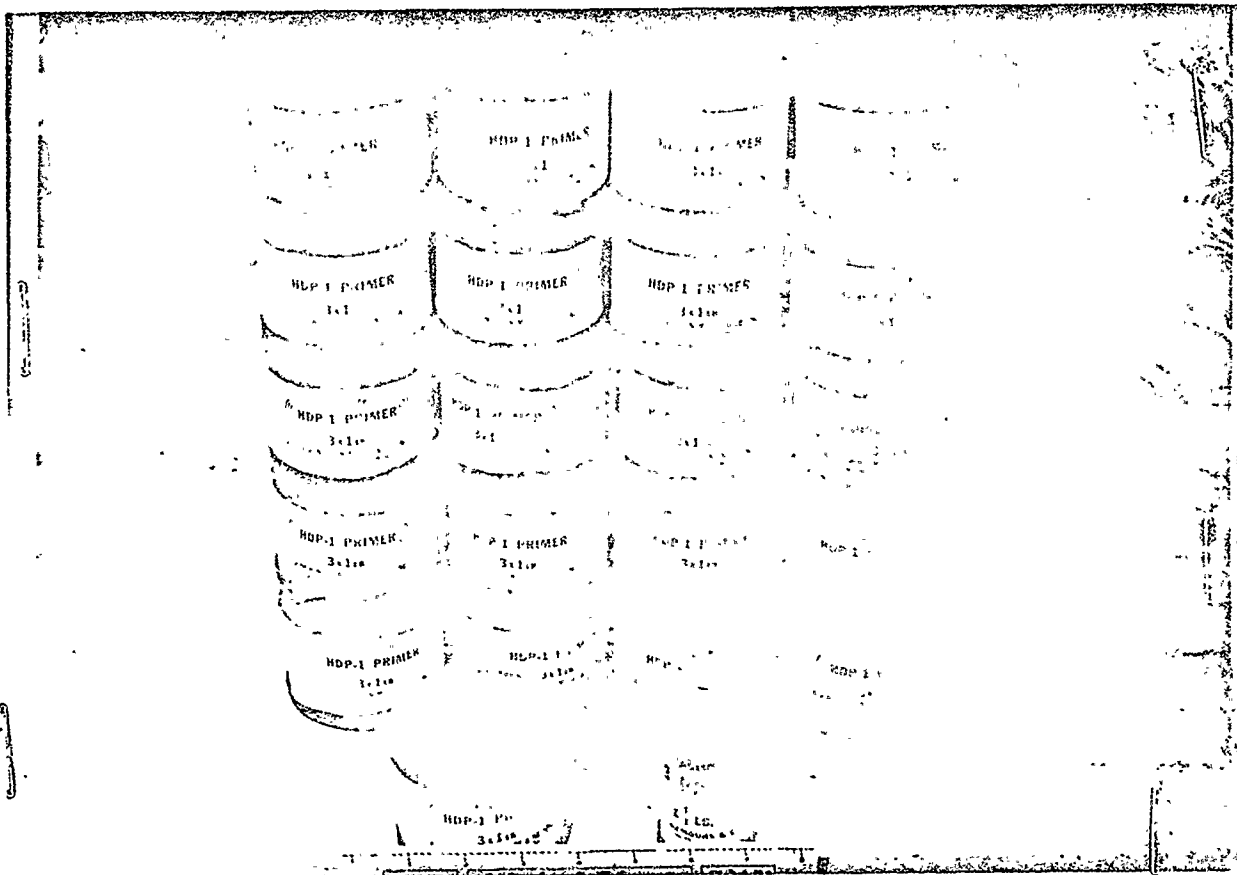

TWENTY CARDBOARD CONTAINERS CONTAINING
HDP-1 PRIMER.

SECRET ARMY ORGANIZATION (SAO)

ARMS CACHE - CUYAMACA PARK

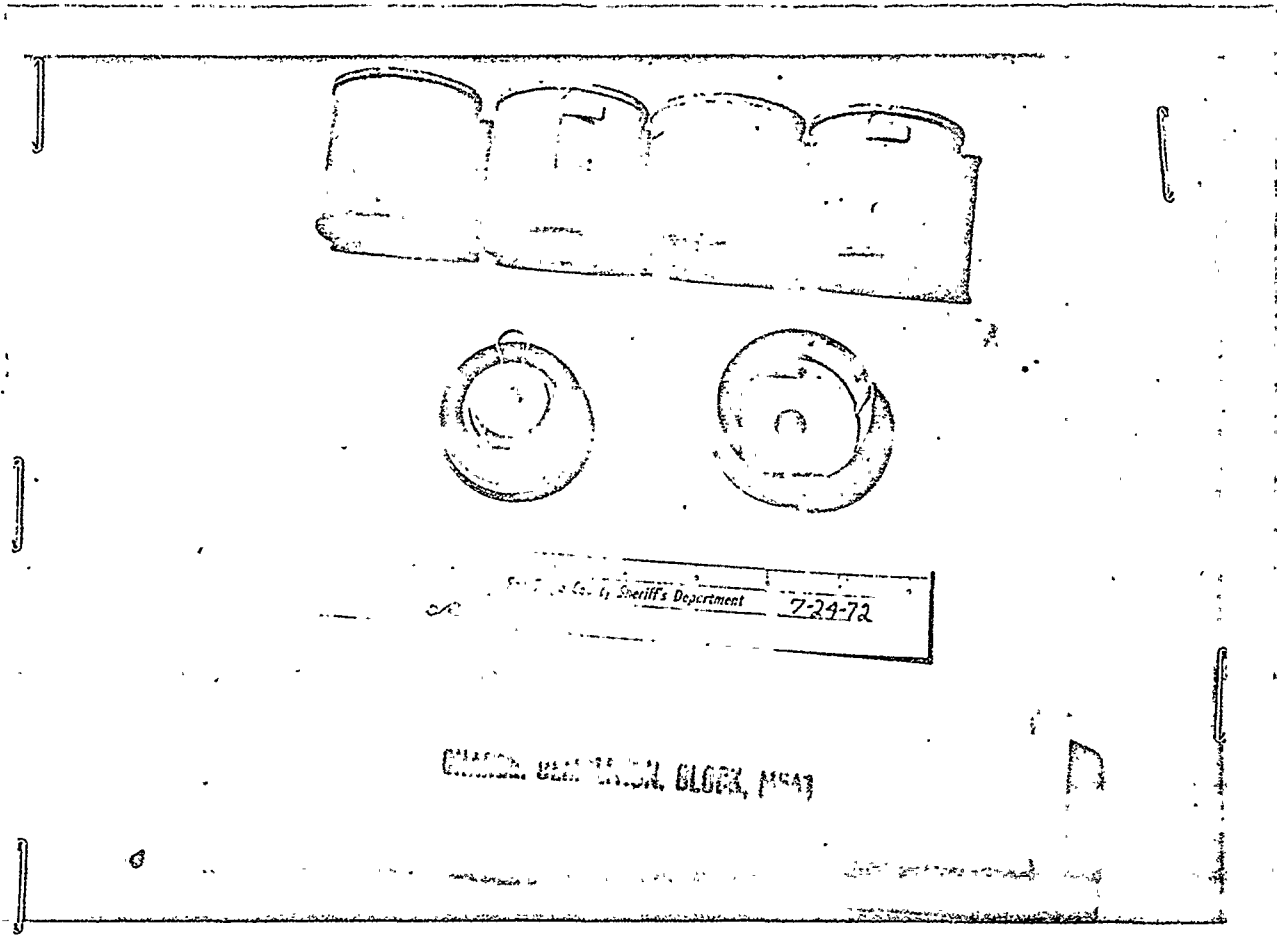

AT THE TOP OF PHOTOGRAPH, FOUR MINE FUSE CONTAINERS, AND AT THE BOTTOM, A DEMOLITION CHARGE.

SECRET ARMY ORGANIZATION (SAO)

SECRET ARMY ORGANIZATION IN-
STRUCTIONS AND MATERIAL

The following samples of SAO literature propaganda and instructions are identical with SAO material seized in the course of searches and arrests referred to previously in this communication. The majority of the individuals arrested had identical packets of this SAO material:

The material hereinafter is as follows:

SECRET ARMY ORGANIZATION (SAO)

(1) APPLICATION TO JOIN THE SAO

(PAGE 30)



SECRET ARMY ORGANIZATION

GENERAL HEADQUARTERS



FROM: S. A. O. HEADQUARTERS

TO: FELLOW PATRIOTS

Greetings:

You may or may not have heard of the Secret Army Organization. In the past many patriotically oriented para-military groups have come and gone. Today the leadership of the S. A. O. is made up of those men who have weathered the storm of opposition and are more dedicated than ever to fighting the socialist parasites that are trying to enslave America.

If you care to join us we would welcome your application. However, we solicit your aid in any way that you can help. Your name has been coded so that you may contact us in a secure manner. Just use the coupon below or use the code number on it.

Sincerely yours,

Captain Jordan Wells
S. A. O. Headquarters Staff

Mail To: S. A. O.

P. O. Box 5791

San Diego, California 92105

Code Number _____

- Please send membership information and application form.
- I wish to contribute \$_____ to help with the fight.
- I will help distribute literature, posters, leaflets, etc.
- I wish to be removed from your mailing list.

SECRET ARMY ORGANIZATION (SAO)

(2) HISTORY OF THE SAO
(PAGE 32)

History of the Secret Army Organization

One early morning in February, 1970, a group of six Minutemen leaders from four states met secretly in Northern Arizona to discuss the crisis that the arrest and imprisonment of two top Minutemen leaders and the assassination of a third had brought on the organization. Although some of these men had met before in their roles as Minutemen group leaders, others were meeting for the first time.

After much discussion, two principal points were agreed upon. First, that the Minutemen as a national coordination organization of militant right-wing groups had effectively been destroyed by the pro-communist elements inside the Justice Department. While individual units still existed throughout the country, few had the financial support or leadership to be really effective. Second, that the need for such a coordinating organization was greater than ever in view of the increased revolutionary activity by communists in the United States.

With these two points in mind, suggestions were put forward on a course of action to be followed. After a meeting that lasted all that day and far into the next morning, an overall plan of action was finally agreed upon. All present agreed to merge their individual units together and form a new organization under the command of one leader elected from among themselves, with the other five to be members of a General Staff that would advise and assist the new leader.

While retaining the basic programs and policies of the Minutemen, it was decided that not only should this new organization have a different name, but also a completely new chain of command and organizational structure. If the new organization was going to survive the attacks that befell the old one, a whole new approach would be needed. Never again could the arrest or death of a few leaders be allowed to cripple the entire organization.

For this reason it was decided that only a highly disciplined military type organization with a definite chain of command would have any chance of success. This then, was the beginning of the Secret Army Organization. Beginning with an original force of hard core patriots that numbered fewer than two hundred, the Secret Army Organization began the job of picking up the pieces and continuing to fight for national and individual freedom. Using this cadre of dedicated personnel as a nucleus, the S. A. O. has been recruiting and training new members in the skills they will need as the freedom fighters of tomorrow.

The leaders of the S. A. O. have no idea of fighting a last ditch stand. We have no desire to commit suicide ourselves or to let our members do so. We have a strategy which we believe will ultimately lead to victory. Only one thing is essential. We must start preparing and training NOW! We of the S. A. O. believe that our country is worthy of any sacrifice. If you feel the same way, we invite you to join us.

SECRET ARMY ORGANIZATION (SAO)

(3) APPLICATION FOR MEMBERSHIP
IN THE SAO

(PAGE 34)

APPLICATION FOR MEMBERSHIP

NOTICE TO APPLICANT: All information on this form will be kept confidential. All records of members of the Secret Army Organization are stored in a way that they can be swiftly destroyed to keep them from falling into unauthorized hands.

Name _____ Sex _____ Age _____

Address _____ Marital Status _____
(Street)

State _____ Wife's Name _____

Zip Code _____ Telephone _____

Date of Birth _____
(Month) (Day) (Year)

Occupation _____ Education _____

Special Subjects Studied _____

Do You Speak or Read Any Foreign Language? _____

Veteran _____ Branch _____ Highest Rank _____

What Service Training Have You Had That You Feel Would Be Beneficial To This Organization? _____

Physical Description: Height _____ Weight _____ Color Eyes _____

Color Hair _____ Health: Good _____ Fair _____ Poor _____

Any Physical Disabilities or Limitations? _____

Any Public Speaking or Organizing Experience? _____ If Yes, Please Explain: _____

How Many Hours A Week Could You Devote To Working And Training With the S. A. O. ?

Hours _____ Best Time: AM _____ PM _____ Weekdays _____ Weekends _____

CERTIFICATION

I am a loyal American Citizen dedicated to the defense and survival of the United States as a Constitutional Republic, free from all socialist and communist policies. Enclosed is my \$5.00 membership fee. I agree to pay \$3.00 each month to the Secret Army Organization as membership dues.

34

Signature of Applicant _____ Date _____

SECRET ARMY ORGANIZATION (SAO)

(4) LETTER FROM SAO DESIGNATING CODE
NUMBER TO BE USED BY NEW MEMBERS

(PAGE 36)



SECRET ARMY ORGANIZATION

GENERAL HEADQUARTERS

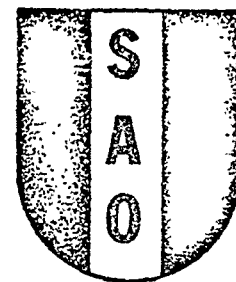

Dear Fellow American,

Your application for membership in the Secret Army Organization has been processed and approved. It is our profound hope that your membership in the S. A. O. will prove to be a benefit to the organization and yourself as well. A dedicated member will find that his association with our organization is a way of life that is far more rewarding than the ordinary mediocre existence of his fellow enlightened citizens.

For security purposes all records regarding individual members are listed by numbers only. Your number will be _____. Please sign all future correspondence addressed to the organization with this number. You need not list your address unless it is different from the one in our records.

Another security measure employed by our organization is the use of mail drops. The mail drop is an address listed in a fictitious name of a person or company not connected with the organization. Each member is assigned one that he will use in sending all reports, correspondence, materials, etc., to the organization. Your assigned mail drop is:

We have a tremendous job ahead of us. Certainly, none of us pretend to know what the future holds for ourselves or for our native land. We do feel, however, that our freedom is gravely threatened. It is not always possible to know the best thing to do. But we do know this - our forefathers have given us a life of freedom and opportunity such as never existed before in all history. We must strive to pass this heritage on to future generations intact.

Our organization is not suggesting or doing anything more than Americans have always done - starting in 1776.

Enclosed is some further information about our organization, its history, objectives, and programs. Your record has been turned over to our training section and you should receive your first training program within two weeks.

Sincerely yours,

30

Captain Patrick McDonald
S. A. O. Headquarters Staff

SECRET ARMY ORGANIZATION (SAO)

(5) INFORMATION TO PROSPECTIVE
MEMBERS OF THE SAO

(PAGES 38 - 39)

To Prospective Members Of The
SECRET ARMY ORGANIZATION

The Secret Army Organization is the most active, most completely dedicated and most selective in its membership of all the many patriotic organizations in America. We are willing to make any sacrifice for our country and we fully expect that some of us will have to make the ultimate sacrifice before victory is achieved. Our very lives depend on each other. There is no place in this organization for bunglers, playboys or lukewarm conservatives. If you join the Secret Army Organization, there might easily come a time that your life would depend on how competently some other member had learned his job.

Unless you are especially well informed on the domestic and world political situation, it is probable that you have a lot to learn about the present threat our nation faces. Unless you have had many years experience in actual underground warfare, there is undoubtedly a lot you can learn from the experts in our organization who have developed and supervised our training program.

OUR NATION IS IN IMMEDIATE DANGER

It is possible that within a very few years, perhaps even within months, our nation could be conquered and enslaved by the communists. To prevent this we must know as much as possible about our enemies. Unless we know who they are and what they are doing we will not succeed in our efforts to maintain a free America.

THE RESISTANCE MOVEMENT

In driving an invader from your land the resistance involved goes through three stages of development.

- 1) The Underground Network
- 2) Active Guerrilla Warfare
- 3) Open or Conventional Warfare

The conventional warfare stage uses everything in the way of weapons that the enemy does but must also have active guerrillas and underground agents working against the enemy, too. In the present state of military tactics conventional warfare cannot succeed unless these other two ingredients are used simultaneously.

The first step is to form an underground network. An active guerrilla system must have the support of an underground network of approximately three times its own size. This underground must supply the active guerrilla fighter with supplies, concealment, information, etc. An underground network starts with departments of intelligence, security and propaganda in that order.

Sabotage, espionage, subversion, infiltration, escape and evasion, training, clandestine fabrication of supplies, counterfeiting enemy documents, recruiting, communications and propaganda are other phases of underground activity. Each member of the Secret Army Organization, to be effective, must have a working knowledge of all these tactics as well as the military tactics more commonly associated with guerrilla activities.

38

ASSIGNMENT TO UNITS

Many people that inquire about membership in the Secret Army Organization seem to have an idea that they will be immediately accepted into an active unit. Look at it this way. Suppose you had spent a year or more carefully recruiting and training until you had a hard hitting team where every individual was reliable, dedicated, and had confidence in his fellow unit members. Wouldn't it make you mad to have the national or regional organization assign some rank amateur to your unit that you you knew little or nothing about?

Before any new member is assigned to an active unit or to an important underground project, he must undergo a period of training. During this training he will be directed through the mails by an experienced member and some of his activities may be observed by other members without his knowledge. Only when a new member proves himself to be conscientious, trustworthy, self-disciplined and able to operate effectively alone will he be accepted as a "secure member" and invited to participate with other unit members in a teamwork operation.

EXPENSES

Unfortunately, most good things don't come cheap. Although we make every effort to keep down the expense of membership in the Secret Army Organization, you must expect to pay your own way.

Dues to the Secret Army Organization are \$3.00 per month. This money is absolutely necessary for use to maintain our central files and headquarters, for postage and printing, to finance our extensive intelligence network, and to maintain training areas.

Each member will have other expenses depending on the type of activity he is engaged in. Every member will be expected to buy his own gun, ammunition and other basic combat equipment. During training the new member may be expected to buy certain books or subscribe to certain magazines that his work requires. During this time the new member will also be supplied with reading material on the strategy and tactics of guerrilla warfare. This home work will make it possible for him to fit in quickly to an active unit and participate effectively in actual maneuvers, marksmanship training, etc.

Following this preliminary training a member may be either assigned to an existing unit, assisted in organizing his own unit if he has shown sufficient leadership qualities or become part of an underground network.

Upon your acceptance into the Secret Army Organization you will be given a definite series of projects described in writing so you will know exactly what will be expected of you.

We hope that you can succeed in this effort because your country desperately needs patriots at this time.

39

Secret Army Organization

SECRET ARMY ORGANIZATION (SAO)

- (6) SAO UNDERGROUND BULLETIN - JANUARY, 1972.
THIS ISSUE DISCUSSES THE ORGANIZATION OF
"DISPERSED TEAMS" AND THE MAKING AND USE
OF BOOBY TRAPS

(PAGES 41 - 51)

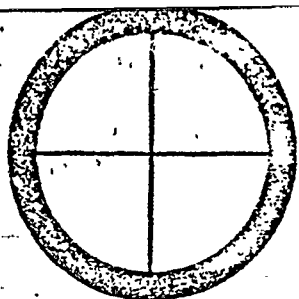

SECRET ARMY ORGANIZATION

UNDERGROUND BULLETIN

GENERAL HEADQUARTERS — JANUARY 1972

"God grants liberty only to those who love it and are always willing to guard and defend it". Daniel Webster

Fellow members,

This month's bulletin will deal mostly with "Booby Traps". Because of the length of this article we are only sending out the first half this month. The second half will be published in next month's bulletin. Future bulletins this coming year will contain material on psychological warfare, urban warfare tactics, communications, survival equipment, first aid, explosives, weapons, codes, and other related warfare subjects.

Those members who have not yet completed or started on the organization's basic training programs are hereby urged to do so. We cannot, in most cases, assign any member to an important underground project or to an organized team or group until they have completed this training program.

While headquarters cannot assign a member in the above classification to an established unit, any member can (and is encouraged to) recruit and form their own combat team (see December 1971 Bulletin). In many cases this may be the best policy in regards to personal security as the member would be working with the people he personally knows and trusts. If any member would like to form their own unit they should write to their assigned mail drop and the organization will send them further instructions along with a Team Recruiting Packet. The article on "The Dispersed Team" in this month's bulletin should help those members who wish to form their own Combat Team.

We are enclosing a small number of S. A. O. stickers with this month's bulletin. Please put them in your shirt pocket or billfold and as soon as possible stick them up in phone booths, at bus stops, or other public places that you visit. The stickers are already gummed and when wet will adhere firmly to glass, metal, or any other smooth surface. If our members would use these stickers along with the leaflets that are available, it would have a real psychological impact on the rest of the American people and give them evidence that there are still those among them who are willing to fight for the re-establishment of a Constitutional Republic. These first stickers are being sent to each member free, additional stickers and leaflets can be ordered on the monthly report form.

THE DISPERSED TEAM

When discussing a Secret Army Organization "Combat Team", we usually think of a small group of people who live very close to one another. Such an arrangement has certain advantages, such as ease of communication and travel for collective training and team operations, but there are also several disadvantages.

Among the disadvantages are these: Team members may be well acquainted with only a small geographical area. If forced to leave this area the team may be placed at a serious disadvantage. It is harder for a team of SAO members who live closely together to keep from attracting attention, thus unit security may be poor. If one member of the team is ever discovered and arrested by the enemy, chances are that all members of the team will be rounded up together.

These considerations have caused us to experiment with a new arrangement that we refer to as a "Dispersed Team". Such a team has the same number of members (usually six) as a regular Combat Team. Each team is split into two sections as is the old team. The members have the same type of individual specialties and duties.

The big difference lies in the fact that the team members may be located over a comparatively larger area - perhaps as much as 25 to 50 miles in diameter. In urban areas one team member may live in each of six different cities. Thus the team may range over a fairly large geographical area with at least one team member being familiar with the immediate territory through which they are traveling.

When active as part of an underground movement (as opposed to the classical forms of guerrilla warfare) the Dispersed Team has several other advantages. For example, if one member of the team gets too "hot" in his area, he automatically has five other hide-outs to which he can go for assistance or to which he can send his family for temporary safety. The Dispersed Team can conveniently cover a larger area in the fields of recruiting, psychological warfare, and propaganda. Operations of sabotage, surveillance and harassment of communist personnel, raids, and other combat type operations can be successfully conducted while moving a minimum of people over a minimum distance.

During the present period of deliberate delay the activities of the team will naturally be different from some future period in which all out warfare between our organization and our country's communist enemies develops.

If the team is to achieve its ultimate objectives the following activities must be provided for: (1) organization of and within the team, (2) communications between the team and higher command, (3) maintaining secrecy of team members, (4) maintaining a continuous and effective propaganda effort, (5) obtaining the necessary supplies and equipment for present and future needs, (6) training of the team in general, and of individual members in their own specialties.

When the required personnel are not available to form a full team, a three man section should be formed. When additional people are recruited the unit can then be expanded in an orderly fashion.

BOOBY TRAPS

Broadly defined a booby trap can be any kind of apparatus in which a reaction unfavorable to the enemy is brought about when he unintentionally makes some act which triggers the reaction. The most common types of booby traps used in warfare involve an explosive charge which is set off by movement of a trip wire or the moving of some object which is connected to the trigger mechanism.

On occasion the explosive charge may be replaced by signal flares, gas, smoke or other chemical agents. The trigger mechanism may be either electric, mechanical, thermal or chemical.

ELECTRICALLY OPERATED TRIGGERS. Such trigger mechanisms are very easily arranged wherever a supply of electric blasting caps are available and also a suitable source of electricity. One of the most common electric type booby traps is to simply interrupt the electrical circuit in some building so that when the lights are turned on the explosive is detonated. This simple procedure applied to an automobile with a few sticks of dynamite has marked the end of more than one gangland hoodlum. To booby trap a car in this manner one side of the electric blasting cap can be attached to any metal part of the car while the other side is attached to a spark plug or the "cold side" of the ignition switch. In the first case the cap detonates the dynamite when the starter motor is turned over or if attached to the key switch detonating occurs when the ignition is turned on.

See PG 132
EXPLOSIVES
DISPOSAL
GUIDE

Any movable object can be booby trapped so that when it is moved some simple type electrical switch contact is closed to complete a circuit between a dry cell battery and the detonator. A very simple example would be to have one wire tacked along the edge of a door and the other wire tacked to the frame and extending out far enough that contact is made between the two when the door is opened. A slightly more refined trigger involves two small springs separated by some thin piece of insulation at one end as shown in Figure No. 1. When pressure is applied, the springs are held apart and when the pressure is released, the springs come together to make electrical contact. This may be placed in a door which is then closed to open the switch while the explosive is wired into the circuit. When the door is opened pressure is released and the charge explodes.

This simple trigger can be placed under the leg of a chair, a wooden box or any other movable object of sufficient weight. If the chair is moved or the box lifted the release of pressure will close the electrical circuit.

A person skilled in the placement of booby traps will not leave any part of the switch, wires or charge visible. Instead of

connecting the wires to the door itself he will take off the door frame, place the trigger mechanism at the edge of the door and then replace the frame so that the entire mechanism is hidden when the door is closed.

By taking off the frame of a window and drilling a hole out through the window casing the trigger mechanism can be placed so that the charge will be detonated by either raising or lowering a half open window.

A simple time delay mechanism can be arranged by placing one of these triggers under a glass jar filled with water. When enough of the water evaporates, the weight of the jar will no longer be sufficient to hold the contacts open.

Figure No. 2 shows another simple electrical trigger made from a spring clothes pin. The improvised contacts are held apart by a small wooden wedge in the jaws of the clothes pin. This wedge can be attached to a trip wire or other movable object. When it is withdrawn the clothes pin shuts and the electric circuit is completed.

A trigger of this type can be used to make a time delay mechanism in many different ways. The wedge may be connected by a loose cord to the end of a spring which is also attached to a tin can. Above this a second tin can full of sand or water is placed with a hole in the bottom so that the contents gradually fall through into the second can. When the weight of the lower can becomes enough to stretch the spring sufficiently the wedge will be pulled from the clothes pin. As an alternate method the spring may be already stretched out and held there by a second cord attached to some other solid object. The cord holding the spring could be placed through a candle so that it will be burned in two when the candle burned down a certain distance. An active imagination can devise countless ways for activating this type of trigger either by instant action or delayed action.

A clever derivative of this simple trigger is used in the "British book trap". In this case a book is hollowed out to contain a small battery and a quarter pound block of TNT which is detonated by an electrical blasting cap. The circuit passes through two contacts attached to opposite pages of the book but are held apart by some insulating material which is attached to the back of the bookcase. If the book is withdrawn from the case the contacts come together and the TNT is detonated.

A British ball bearing contact switch is shown in Figure No. 3. This type of contact is very useful in placing charges entirely within a movable object. For example, a suitcase could be laid on its side with the contact positioned inside in such a way that when the suitcase was picked up the ball bearing would roll forward and complete the contact. Similar electrically activated booby

traps could be placed in closed gasoline cans, canisters, ammunition boxes or drawers of other objects which an enemy would place right side up before opening. A plastic or glass test tube could be used instead of a metal case by sticking two wires through the cork in such a manner that the ball bearing would come in contact with both of them.

A surprisingly accurate timing device can be made with a tube of this type. Holding the tube with the open end up, first pour in a quantity of dried peas, then a measured amount of water, drop in the ball bearing (in this case a wad of tin foil could be used as well), finally put the cork in the top with the wire sticking down through. The water will cause the dried peas to swell which will push the ball bearing (or wad of tin foil) up until it makes contact with the two wires to complete the circuit. The time can be regulated from a few minutes to several hours depending on the length of the tube, the amount of water, and the quantity of peas used.

Far more sophisticated types of electrical triggers are manufactured some of which operate by photoelectric cell or even more difficult to recognize mechanisms. These may be used to safeguard record centers, important military or missile bases, etc. but are seldom encountered under battlefield conditions.

MECHANICAL TRIGGERS. These may be operated either by impact or by friction. The ordinary hand grenade employs an impact trigger. When the handle is released a spring operated lever snaps against a cap (similar to the priming cap in a shotgun shell) which in turn starts a short fuse to burn. This fuse leads to a blasting cap centered in an explosive charge.

The trigger mechanism of a "potato masher" hand grenade operates much like the firing pin of a bolt action rifle. In this case a spring activated plunger strikes a detonator. The plunger may be released by pulling out a pin as shown in Figure No. 4, by cutting a wire as shown in Figure No. 5 or by applying pressure to a slotted key as shown in Figure No. 6.

Explosion of the primer cap alone is not sufficient to detonate most military explosives. Generally a booster charge of a fairly sensitive explosive is detonated by the primer and this in turn detonates the main charge. In military use TNT is by far the most common explosive used in the main charge of booby traps.

So called "plastic explosive" or "Composition C-3" contains 78 percent RDX and 22% plasticizer made up of mixture of dinitrotolune, TNT, nitrocellulose and dimethylformamide. RDX is cyclotrimethylenetrinitramine which is manufactured by nitrating hexamethylenetetramine (which is obtained by the reaction of formaldehyde and ammonia).

Booster charges where necessary are usually tetryl or PETN. Common explosives used in primers are lead azide, lead styphnate

*Greek to
all but
PHD's
in
Chemistry*

or the now largely discontinued mercury fulminate. Characteristics, uses and manufacture of explosives will be dealt with in another chapter.

A very simple device can be made from a screen door spring that will explode an ordinary rifle cartridge when activated by a trip wire. Although the "explosion" is almost harmless it can be very nerve racking to an approaching enemy.

A more deadly booby trap consists of a short piece of pipe which is driven into the ground. A plunger type trigger mechanism is dropped into the pipe and an ordinary rifle cartridge placed point up in the pipe so that perhaps one-half inch is exposed above the ground. The weight of a man stepping on the bullet releases the trigger and fires the cartridge which will penetrate well up into the leg or the body.

Some mechanical triggers are activated by friction just like striking a match on the rough material of the match cover. Figure No. 7 shows a cut-away drawing of the U.S. Army firing device, pull friction type M-2. The coated wire is covered with a gritty substance much like the strip on a book of matches. When this is pulled out through a container of flash compound (chemically similar to the match heads) the friction ignites the flash compound which may be used either to light a fuse or fire a blasting cap.

A crude but effective friction device can be prepared by sticking the end of a fuse in some small cylinder filled with match heads through which is placed a small strip of tin or heavy cardboard with a friction strip from match books glued to both sides.

In field use the friction type ignitor can be hidden in many ways connected with trip wires or attached to movable objects to set off either instant or delayed charges.

THERMAL IGNITORS. In some cases the ignitor, (fuse or primer) can be used as a trigger mechanism. For example in World War II the Germans were known to tear down fireplaces and cement them back together with hidden charges that would ignite when a fire was built. A simple hand grenade or mortar shell hidden in a hollow log by a burned out fire would, of course, explode if the log were used as fuel without being inspected.

A common trick is for a retreating army to leave behind coal oil lamps or lanterns filled with gasoline. An unthinking person who touches a match to such a lantern will nearly always be burned to death.

CHEMICAL TRIGGERS. These are more frequently used in the construction of time bombs than in booby traps. Figure No. 8

shows an Italian chemical delay igniter. The upper chamber contains acetone. When the piercing pin is pushed downward it penetrates the lead disc and allows the acetone to flow into the lower chamber. The acetone gradually dissolves the celluloid washer which holds back the striker. The time delay can be varied by placing different numbers of cellophane washers on the striker rod.

In several similar types of delayed mechanisms the striker is held back by a thin metal wire which is gradually dissolved when a solution of acid is allowed to surround it.

Other types of delay mechanisms may be constructed where a liquid is allowed to drop through a small hole into a lower container having a reactive substance attached part way up one wall. The liquid level in the chamber gradually raises until it comes in contact with the reactive substance which is the igniter. One suitable combination is sulfuric acid for the liquid and a mixture of potassium chlorate and sugar for the solid. Another suitable combination is plain water for the liquid and metallic sodium for the solid. There are many other combinations which a chemist might improvise from materials at hand.

There are some explosives so sensitive that they can be used as trigger mechanisms. Ammonium tri-iodide can be made from ordinary household ammonia and iodine crystals. If the iodine crystals are not available they can be obtained by evaporating sufficient volume of tincture of iodine in a flat glass dish.

Place two or three teaspoons of iodine crystals in a piece of kleenex and wet thoroughly with strong ammonia solution. A small amount of ammonia may be added from time to time making certain that it does not have the chance to dry out. After three or four tablespoons of ammonia solution have been absorbed and partly evaporated from the iodine it can be left to dry out. While wet ammonium tri-iodide is reasonably safe to handle. When dry, it is so sensitive that it detonates at the slightest touch. It may be exploded by a person walking on a wooden floor several feet away or a door being closed in the same building. The amount described above will produce a violent explosion and should be treated with extreme caution. Several similar compounds will be mentioned in the chapter on explosives.

How
MUCH IS
LEFT OUT
???

One or two teaspoonsful of mercury fulminate of silver fulminate mixed (very gently) with ten percent coarse sand can be placed in a small packet of paper and attached to the upper side of an automobile tire with adhesive tape. When the tire rolls over it the fulminate will explode with sufficient power to destroy even a husky truck tire. These combinations also are very dangerous to handle.

READY MADE BOOBY TRAPS

All national armies are supplied with a variety of manufactured trigger devices, charges, etc. to be used specifically as booby trap material. Most firing devices are threaded on one end with a standing size that allows them to be used either with prepared charges or with improvised charges made from mortar or artillery shells. Figure No. 9 shows a simple firing device attached to a hand grenade.

An antipersonnel mine of French manufacture is shown in Figure No. 10. The apparatus at the left side is a trigger mechanism that can be operated by a trip wire. When it is fired the flash passes through the "U" tube which propels a 60mm grenade into the air and at the same time ignites a 1/5 second delay pellet. The grenade explodes a few feet off the ground to shower metal fragments over a wide area. Total weight of mine is 5-1/2 pounds.

Guerrilla bands have sometimes used artillery shells or mortar shells in demolition work by placing them in a large pile of wood or other combustible material and building a bond fire around them until they exploded. For booby traps use, however, the projectile of an artillery shell is the only part of any value. Useful sizes include 75mm, 90mm, 105mm, and 155mm. In those artillery shells where the projectile is attached to the case, it is generally best to remove the projectile and discard the case. Artillery shell projectiles may be fused either in the nose or in the base. For most efficient use, the regular fuse must be unscrewed and a standard firing device (M10 Universal destructor) put in its place.

IMPROVISED BOOBY TRAPS

Standard hand grenades can be used alone in booby traps in a number of methods. The simplest is to carefully remove the handle and wedge the grenade between two heavy objects strong enough to hold the spring in the cocked position.

Another trick is to cover a hand grenade with wet mud with just the safety pin ring sticking out. After the mud has hardened, it will hold the handle in place and the safety pin ring can be withdrawn. These harmless looking clumps of mud scattered along a dirt road will, of course, break open when hit by an automobile tire which will release the handle and fire the grenade. A similar trick is to place grenades in glass jars tight enough to hold the handle in place when the safety pins are withdrawn. At night these may be strung on a wire across a road and may not be seen by a car traveling at night with its lights off. When the bottles break the grenade handles are released and they soon explode.

It seems doubtful that man's ingenuity will ever be exhausted when it comes to improvising traps of various types. A rusty nail stuck to a board left where it will be stepped on by a running enemy may be just as deadly to that one individual as an atomic bomb. Open pits (sometimes with sharp stakes at the bottom) covered with flimsy camouflage is much older than the bow and arrow, but were still used by the Japanese in World War II.

"Dead falls" made from heavy tree limbs that fall when a victim releases them by tripping over a jungle vine can still be useful in guerrilla warfare.

Leaving behind poisoned food or bottled drinks is common. Alcoholic drinks are easily diluted with wood alcohol (temporary type antifreeze) equal to 1/4 their content of ethyl alcohol without detection. A total intake of 2 or 3 ounces will cause blindness or death in a few hours. Soft drinks can be easily poisoned with ethylene glycol (permanent type antifreeze) at the rate of 2 ounces per bottle. This dose is usually fatal and once symptoms develop there is no known antidote.

When five parts of potassium permanganate is mixed with one part of powdered sugar it forms a combination that will either explode (if confined) or burn with a flash if ignited in the open. A new idea might be to put three or four tablespoonsful of this material in an ash tray covered with a thin dust of cigarette ashes. The first person to put his cigarette out in that particular ash tray would be burned bad enough to be out of commission for quite some time. Black powder, if available, would actually explode if used in this way.

USE OF BOOBY TRAPS

It is obvious that the use of booby traps favors an army in retreat, and one of their greatest uses is to slow down pursuit. For most efficient use the laying of booby traps must be done in a planned and coordinated method. When time permits the entire area to be booby trapped should be reconnoitered and the placement of available material planned in such a way as to confuse the enemy, impede his progress and cause maximum number of casualties.

Generally speaking a large number of small booby traps are preferred to a few large ones. Two or more triggers may be attached to a single charge. Variety of types and settings is essential to effective use of booby traps in large numbers.

In the event that friendly troops or your own personnel may re-enter such an area later on, it is desirable that a written record and detailed maps be kept as to where booby traps are placed. When U.S. Army troops discover a place that is booby trapped they mark it with a sign which consists of a red triangle

pointed downward with a white circle in the middle and the word booby traps painted in white across the top.

When anti-vehicle mines are placed by regular army forces it is common practice to booby trap the mines so they will explode when being removed by personnel attempting to clear the area.

The use of booby traps is very adaptable to both guerrilla and counter-guerrilla activity. Guerrilla warfare involves two basic types of action: ambushes and raids. When the guerrillas ambush regular army forces, they are the ones that will make use of the booby traps. In raiding an enemy garrison or supply depot they must beware of booby traps that the regular forces have placed to protect their fixed positions.

The ambush may start when the leading vehicle of an enemy column strikes a mine or drives on to a bridge which is dynamited. Perhaps time delay booby traps activated by the first vehicle in the column may be used to destroy other vehicles several positions behind. Troops riding in a truck convoy may be expected to seek cover in ditches beside the road or other points of natural protection. If these ditches have been booby trapped beforehand, they will be killed in the very process of seeking shelter.

Before making any raid on a fixed enemy position, guerrilla forces should carefully consider the potential danger of booby traps. When regular army forces are being harassed by guerrillas they may be expected to leave supplies badly needed by the guerrillas in slightly protected warehouses as traps. These supplies may be heavily booby trapped and counter guerrilla forces may be waiting a short distance away to take pursuit. To guard against these things, the guerrilla should attempt to keep their target under surveillance for several hours or days before making the raid. They should observe the coming and going of enemy personnel. If the enemy is very careful to always come and go by the same route it may mean that other routes are booby trapped. If the supplies are not added to or taken from regularly, this may indicate that they are being used to bait a trap. By scouting the general area guerrilla forces should guard against surprise by other enemy forces waiting within danger distance.

After making either a raid or an ambush, guerrilla forces should place booby traps behind them to slow up pursuit. Real booby traps can be interspersed with imitation traps. To be safe the enemy will have to go around or de-activate the imitations and take just as much time doing so as if they were real. If the enemy becomes careless in handling your imitation traps, he will run the danger of getting killed by a live one. In planning the path of their retreat guerrilla forces should booby trap alternate routes which enemy forces might use to cut them off.

MEMBERS REPORT FORM

Please fill out and return to your assigned mail drop as quickly as possible. If you have not yet been assigned a regular mail drop, Mail to: P. O. Box 5791, San Diego, California 92105.

CODE NAME OR IDENTIFICATION NUMBER: _____

ADDRESS: _____ ZIP CODE: _____
(Only if changed from last month)

BASIC CORRESPONDENCE TRAINING PROGRAM: (Enclose \$3.00 for each program)

- Intelligence
- Security
- Propaganda
- Recruiting

Special Note: Each program must be ordered only upon completion of the prior program. Enclose payment when ordering each program.

SECRET ARMY ORGANIZATION MATERIALS:

- S. A. O. Stickers (50 for \$1.00)
- S. A. O. Leaflets (50 for \$1.00)

Other Materials Needed: _____
(Recruiting forms, Histories, Etc.)

S. A. O. DUES FOR _____ CONTRIBUTION TO S. A. O. _____

S. A. O. DUES FOR _____ MATERIALS _____

TOTAL ENCLOSED _____

DESCRIBE BRIEFLY YOUR ACTIVITIES PERTAINING TO THE ORGANIZATION DURING THE PAST MONTH.

FIGHT COMMUNISM

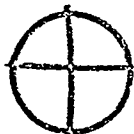

join the
SECRET ARMY ORGANIZATION

write
SAO Box 5791, San Diego, Calif. 92105

s.a.o. sticker

51

SECRET ARMY ORGANIZATION (SAO)

- (7) SAO UNDERGROUND BULLETIN - MARCH, 1972,
WHICH DISCUSSES THE ORGANIZATION OF AN
UNDERGROUND GROUP

(PAGES 53 - 64)

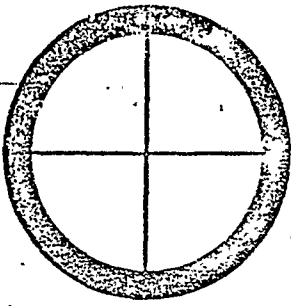

SECRET ARMY ORGANIZATION

UNDERGROUND BULLETIN

GENERAL HEADQUARTERS

MARCH 1972

"He who accepts evil without protesting it is really cooperating with it."
— Thoreau

organizing your underground group

The most effective underground movements are built step-by-step. They begin with intelligence networks and the dissemination of propaganda. Gradually the movement includes passive, then active sabotage. Finally it develops into full time underground warfare. There may be times when surprise attack or special circumstances may require immediate armed resistance but such resistance cannot be fully effective until the intelligence and propaganda services can be developed to an equal extent. If proper sources of information are developed prior to military action many possible traps and expensive mistakes can be avoided.

Once a country is at war or occupied by an enemy, recruiting new underground members is a very hazardous occupation. Suspicion and fear lie like a blanket over the people. Neighbors are afraid to be seen talking together. Even friends become guarded in their talk.

These are the reasons why we advocate forming your group now - while you can still do so in comparative safety. It is like insurance purchased in hopes that you will never collect. If the need for active combat never comes this will still not be time wasted. You will surely gain true friends. You will surely profit by a better understanding of your neighbor's point of view. You will certainly add to your appreciation of the courage and dignity of your fellow Americans.

It is best if your group can be made up of people who have known each other previously and who already respect one another's ability and loyalty. Unfortunately this is not always possible. So long as personal existence is possible most people will try to "exist" under the yoke of slavery. Only here and there will you find a person with the courage and conviction to join in active resistance against the enemy.

The communists are well aware of these facts. They are constantly trying to ferment distrust among the peoples of the free world. Even here in the United States many intelligent and responsible people are losing their confidence in one another, in their

law enforcement agencies and in their government itself. This is not said with the intention of being hypercritical. It is merely a statement of fact.

During the past thirty years our nations "foreign policy" has repeatedly played right into the communist's hands. As a result one free nation after another has been handed to the reds on a silver platter. Time and time again these "mistakes" have been concealed from the people or have been white-washed by persons in high government office. How can anyone blame the American public for beginning to wonder?

All too often people who have tried to call attention to these facts have themselves been smeared as "fascists", "extremists", and worse. The following is quoted from the American Legion Magazine, November 1961:

"Although Americans generally have no use for communism, many protest vigorously whenever an attempt is made to expose or discredit communists....No sooner is an anti-communist organization launched than it is attacked, hissed at and spat upon. The same is true of INDIVIDUALS from the moment they assail the twin evils of communism and communists.

Why do so many Americans join the never ending campaign to discredit and destroy those who are fighting their battles against communism for them and in the process, risking their reputations, their livelihood, their health, and even their LIVES. How is the phenomenon of perversity to be explained?!"

How indeed? Yet this situation does exist and added to the suspicion that has developed among our countrymen, it makes people reluctant - even afraid - to exercise their rights of free speech and peaceable assembly.

During the past few years thousands of "study groups" and similar anti-communist organizations have come into existence. As those who belong to them know, many people are "too busy" even to inform themselves as to the true nature of the communist-socialist menace. With this in mind you might imagine it would be very difficult to get people to spend their own money for arms and then get them out in the open where they can train in the use of such arms.

Strangely enough, we have found it much easier than you might think. It may be that people have developed a sense of futility about writing their congressmen or working for political candidates (presidents come and presidents go but the old bureaucracy just keeps rolling along).

Since World War II billions of words have been spoken by the negotiators and the propagandizers in the "cold war". Still the free world is losing steadily. The people have lost faith in words. Few believe in the power of words anymore.

If you approach them in such a way as to prove that you are yourself sincere, you will

find among your own acquaintances many who are tired of talk and who will be glad to find some constructive action which they can enter into.

AS YOU FORM YOUR OWN GROUP KEEP THESE FACTS IN MIND:

(1) The underground needs all kinds of people, young and old, men and women. Those who the enemy "would never suspect" can act as spies and messengers. The underground needs many different things in addition to fighters : sources of supply, lines of communications, a multitude of skills that can be supplied by many different kinds of people.

(2) To voluntarily start training in the use of arms, especially in the absence of a declared state of war, requires a deep personal conviction that this must be done now for the salvation of ourselves and our country. If you do not believe this yourself you will never be able to pass the necessary conviction to other members of your group.

(3) A small group that is resolute and dedicated will be more effective than a large group containing people that my doubt the importance of their cause.

For a batallion of men to attack the enemy in the face of gunfire requires courage. For one or two men to fight alone in the dark requires bravery. For the wives of such men to spend the night waiting and wondering requires even greater bravery. These are the type of people you MUST collect about you.

It is natural for living things to want to keep on living. The kind of bravery we are talking about is not something people are born with. It is something that a person must develop within himself. It comes only from the absolute belief that our cause for freedom is more important that anything else in this world.

Where can you find such people? You find them among your neighbors, among the people you work with, among your friends and your relatives. You might never guess it as you move among these people in their daily lives but there are countless numbers of Americans who share this belief with you.

This does not mean that such people are going to be immediately enthusiastic about forming an underground. Some may, but others may never have had an opportunity to learn the true facts about our national and international situation. That's where you come in. You must be able to convince such people that they cannot afford to wait until the last minute before the get prepared.

To convince others you must first be sure of your own facts. The organization has several pieces of literature available which exposes the communist threat inside America as well as books on guerrilla warfare.

Remember, the formation of a group should first start with intelligence and propaganda. Don't mistake what we mean by "propaganda". Some people have the idea that this re-

55

fers only to informati this is false and misleading. Propaganda refers only to the use of information to attract people to your way of thinking. Truth is the best possible kind of propaganda.

Here then are the step-by-step suggestions on how to go about forming your own group:

1. Know the truth. Be able to back up your view of the current situation with facts and references.
2. Make a list of everyone you know even casually: friends, fellow workers, neighbors, lodge or church members and relatives.
3. Renew old acquaintances. Get to really know these 'people. Feel them out on current events, politics, and world affairs. Let them know where you stand.
4. Do not choose people just because you think they would be willing to join your group. Choose instead those that you want in your group. Remember that if fighting actually starts these people will be closely associated with you and themselves for long periods of time. Eliminate the braggarts. Pick the quiet confident people that won't get on each others nerves when the going gets tough.
5. After you have decided on a list of five to twelve people you are ready to give them your "sales talk". You can do this with each one individually or you can get them together as a group for this purpose. If you talk to them singly you can maintain a greater degree of secrecy about other members of the group.

Group discussion has the advantages that each prospect is more likely to take your viewpoint seriously if he is sitting down among other people who seem to be taking it seriously also. Since you won't be taking up anything too secret during your first two or three meetings, there will be plenty of time to eliminate any doubtfuls, or more likely, they will eliminate themselves.

6. Whether you talk to your prospective group members singly or as a group, your first discussion should convince them of these things:
 - a. That the free world is losing the cold war against communism.
 - b. That as things are now going we will keep right on losing and that sooner or later Americans may be forced to defend their own property and their own families by whatever means are still available to them.
 - c. That your small group may not be able to do anything to change this situation but in any event you should get together regularly for at least a few meetings to examine any possibilities that may exist.
 - d. Be willing to admit that things may not actually be as bad as you believe but get your prospective group members to at least admit that they owe it to themselves to discover the facts.

- e. Get your prospects to do some reading. Loan them books and pamphlets. Use anti-communist and U.S. Government literature to back up your own arguments.
- f. By all means set up a definite place and schedule for future meetings.

7. If you decide to begin the organization of your group by having them all meet together for your "sales talk", here are some additional points that have proven effective many times in the past for other members.

- a. Hold the meeting in your own home if possible. Otherwise, reserve a room in one of the downtown hotels or motels well ahead of time.
- b. Give your prospects an invitation at least two weeks ahead of time and ask them to confirm at least a week before the meeting that they will be there.
- c. Do not tell them exactly what the meeting is about except that it is a matter of "mutual importance". They should be told that if they come it must be with the understanding that they will arrive on time and will not leave before the meeting is over.
- d. Where a married person is invited the invitation may include both husband and wife and they should both be urged to attend if at all possible. If one is absent he or she will not understand the importance of the project and may object to the time or money which the other will spend on future activities.

8. - When you get your group together, start the meeting off promptly and in a business like manner.

It is certain that there will be a lot of questions about your plans and objectives. If you are organizing as an affiliate of the organization, they will want to know more about the parent organization: how and why it was formed, and they will need to be convinced that they are not going to be considered radicals for entering into this preparation.

Here is where your own knowledge and skill is all important. You must assure them there is nothing illegal about this activity. We are urging them to act only as individuals under their own constitutional right of free speech, peaceable assembly and the right to own and bear arms.

If you feel that your group is not completely sold on your presentation, it may be best to postpone much discussion of the organization until a second meeting.

After your first small group is formed further members should be recruited on a selective basis. In this way you may include the many different skills needed without the size of the group getting too large. By each member having a special task to do their interest and enthusiasm will be maintained at a high level.

Remember that an underground needs many things in addition to fighters. Your fighters alone without proper spy networks, supply lines, and community support would soon be surrounded, starved out, or betrayed. In addition to your fighting group members who

all know each other, you should enlist the assistance of many other people who are sympathetic to your cause and willing to help in their own way although they should know no more about your members or operations than necessary to gain their cooperation. They will form an auxiliary force to work with the individual group member who is responsible for their special activity.

The group leader, if he is to successfully maintain his position must by one means or another make certain that all six of these activities are provided for.

ORGANIZATION:

The organization of the group is primarily the responsibility of the group leader. He must interview personally each new prospective member and make certain that they are suitable material. This means more than simply being loyal to the United States. The prospective member must be impressed with the fact that he is undertaking a grave responsibility. He must be made to understand that even though he has joined the group on "faith" rather than from complete knowledge of its overall activity, that withdrawing from the group will not be easy and that if he should in the future withdraw from the group that he will ever after be considered as suspect by the other group members. The prospective group member must be a type that will get along well with other people. He must not be a braggart or a show-off. Under no circumstances must he become intoxicated or loose-mouthed. He must be a willing worker and ready to assume his share of the load.

The group leader should determine the skills and interest of his members. He should talk over with them the various tasks that need to be performed and ask for volunteers until each member has a responsibility that they are interested in and that they are capable of fulfilling. Since membership in the organization is essentially voluntary the group leader cannot force any member to perform any activity against his will and should not attempt to do so. When a member assumes responsibility for a certain field of activity he must realize that he will be expected to fulfill that task successfully regardless of any other conditions that may arise. If a member is unwilling to assume responsibility on this basis, he should be given another responsibility that better fits his capabilities or should be gracefully eased out of the organization.

INTELLIGENCE:

Intelligence includes all types of information that may be of value at either the national or local level. Scraps and bits of information that may seem of little value alone may eventually fit into a pattern that will someday provide important information for either defensive or offensive action, either propaganda or open warfare.

The group member in charge of intelligence should enlist the assistance of several non-combatants to help gather this information. One or two of these should read all the local and regional papers carefully every day. It's surprising how much information can be picked up from these sources concerning individuals that may be active in communist front activity. If one or more members of the group are union members, they should provide the union papers for examination.

Other auxillary member should take part in church and PTA activities to guard against communist infiltration in these areas. A reading and study group should be set up to study school textbooks and teaching methods in your area for collectivist-socialist-communist slanting.

An auxillary member should carefully evaluate all of the "Letters to the Editor" that appear in various papers in the area. Those who express especially patriotic sentiments and those who are outspoken in their defense of the American constitution and way of life should be turned over to the recruiting officer who can contact them as potential members or auxillary members. Those who advocate collectivism in any form should be turned over to the security officer who can look up their full names, addresses, etc., and file them away among the potential turncoats.

The intelligence officer should evaluate all the information sent to him by his auxillary members to determine the sentiments of people in his area especially those in politics or in a position to influence other people. He should pass on to the regional headquarters any information that involves national or international figures or organizations where in turn it will be compiled with other information and sent on to the national headquarters.

SECURITY:

The security officer must be responsible for secrecy within the group and about the group. We have learned that those members whose membership or identity becomes known will in all probability be subject to abuse and harrassment from the liberals and communists. Therefore, one major duty of the security officer is to prevent the identity of the group's actual members from becoming known.

He should also review from time to time the methods of communications between members of the group. He should insure the secrecy of the meeting places and the training sites. He should arrange for at least two or more secret addresses for receipt and delivery of mail between groups and particularly the regional coordinator. He should be careful that the amount of mail, frequency of meetings, number of parked cars and similar circumstances do not draw attention to the group or its activities.

One of the security officers most important projects is to arrange for a number of "safe houses". These are people both in city and rural areas who have no contact with group members at all and who are quite ordinary in their daily life and yet have a strong sympathy for the organization. They must be willing to care for wounded members or provide hiding places for group members that have been discovered by the enemy. If the communists take over this country from within it is quite possible that the underground and its members will be declared outlawed and it is also possible that individual members may be "framed" with false charges. To hide out a fugitive under these conditions would require a great deal of faith as well as courage. Unfortunately a great percentage of the great American public has neither. Even so, the obtaining of such refuge houses may be essential to the groups ultimate survival and must be arranged for at all costs. Only the group leader, the intelligence officer and the security officer should know the location of these "safe houses" except for the individual member who may put the group in touch with individual locations.

PROPAGANDA:

Until such time as fighting might actually break out we must expect to engage in a continuous propaganda warfare against the communists, communist sympathizers and dupes within our borders. Our ultimate victory or defeat may depend on the outcome of the propaganda battles that we are fighting right now.

By planted newspaper articles and by slanted programs over radio and TV the enemy is even now trying to "smear" us out of existence. They are also starting an all-out campaign to outlaw the use and ownership of firearms by civilians.

During the cold war period the propaganda officer should act as a public relations man for the organization in his locality. It is important that this individual make a good personal appearance and be able to speak and write well. Without actually admitting that he is a member of the organization, he can still contact various news media, television, etc. and ask them to find out the true facts about the organization before blindly repeating half truths and insinuations that come over the wire services or that they read in other papers and magazines.

Whenever local papers carry articles detrimental to the organization, he should have all members, auxiliary members, their friends, relatives, and associated groups flood that paper, radio or TV station as the case may be with both signed and unsigned letters demanding a retraction.

In cases where some particular news media makes a habit of slandering the organization or when some particular news commentator or TV personality does so repeatedly, then the organization should write repeatedly to the companies that place advertising with them to demand a retraction.

Articles or comments which are actually libelous should be forwarded to the regional headquarters for investigation and the possibility of law suits against the offending persons.

The propaganda officer should prepare himself to speak publicly and should arrange to give talks to various civic organizations on the importance of the citizen's right to self defense.

RECRUITING:

The recruiting officer should discuss with other members of the group what additional skills are needed and with their help should attempt to enlist the assistance of people who have such skills. He should cooperate with the security officer to determine whether or not prospective members are loyal to their country and have ideals in keeping with our organization. He should receive from the intelligence officer names of prospective members or associates and contact them to evaluate their possible usefulness to the group. If new groups or new group members are recruited through advertising, he should work with the propaganda officer to prepare effective material. A recruiting officer should make a special effort to enlist the cooperation of a reputable attorney to advise the group as to its legal rights and defend these rights in court if necessary. With other members in the group the cooperation of a doctor should also be arranged for.

Together with the security officer he should attempt to find a printer locally who will supply the group with literature on an absolutely confidential basis. All of the other members of the group should be contacted by the recruiting officer and passed on by the security officer after checking any information known about the prospective member with the intelligence officer.

MEDICAL:

This man may be a doctor or one skilled in first aid. In the latter case, he should make contact with a physician who will work with the group to provide necessary drugs, medical supplies and confidential assistance in time of need.

This member will also be responsible for obtaining medical supplies and keeping adequate reserves on hand. He should give consideration to the general health of all group members and should encourage each member to maintain a maximum degree of physical fitness for their age and circumstances. A medical officer should make all group members keep on hand a large amount of special drugs or medicine each member must for his health.

COMMUNICATIONS:

This member of the group should have or obtain a working knowledge of all radio equipment, field telephone, codes and signals. If he is not an amateur radio operator himself, he should work with the recruiting officer to enlist the aid of one or more amateur radio operators either as group members or as associates. He should be responsible for passwords and other words of identifying friendly supporters. He should arrange suitable code phrases by which essential information can be given over the telephone between group members without giving it away in case the phone is tapped.

ARMAMENT AND DEMOLITION:

The armament officer, with the assistance of other group members should see that all of the groups equipment is safe to use and kept in good repair. He should have sufficient knowledge of firearms and weapons to instruct other members in their use and maintenance. He may designate other members to become specialists in certain types of weapons and so forth.

At least one group member should make himself an expert in the use of all types of explosives, booby traps, time fuses, and similar material. In cooperation with the armament officer and other group members he should determine both immediate and future needs and sources of such materials along with means to obtain such items and also the raw materials from which these items can be quickly manufactured.

SUPPLIES:

The supply officer should keep in mind that the organization has no legal status except their rights as individuals. Group ownership of firearms or supplies could be con-

601

strued as raising an army which would be a violation of the law. Although he may coordinate the stock piling or obtaining of material, it must be clearly understood by all that each individual item is owned by some individual member. The supply officer is primarily responsible for the storage of reserve materials.

Each group should prepare a number of escape and evasion kits. These should be of three types:

1. A very small kit which each member can carry on his person.
2. A suitcase size kit that can be kept in the car or home at all times.
3. An inexpensive kit that can be buried at strategic places or hidden in other strategic localities.

TRAINING:

The training schedule may be arranged for by the group leader or he may elect to assign this responsibility to a training specialist. In either case an inventory should be made of the various skills, talents, and knowledge of each member. All members should discuss together the thirty different parts of the initial training program. They should divide these sections up among themselves so that some member can read and study each subject prior to the training session and be prepared to instruct the other members in his own speciality.

FINANCES:

Although the individual group members must be self sustaining as far as their individual equipment is concerned, there will be many expenses that must be met collectively. To fight the propaganda war requires printing, postage, travel, and so forth. Although the individual group members may be able to meet this expense to a minimum degree they will not in most cases be able to finance the maximum effort that is required. The finance officer should therefore consult with the other group members as to means of raising additional money. One possible source will be from people who will agree with the aims of the organization in theory but who are unwilling or unable to take an active part in the program. Such people may be willing to set up a series of regular monthly contributions to help finance our fight against communism.

In small groups one member may have to double up on two of these duties. In larger groups, the division of responsibility may be spread among a greater number of individuals and still other duties may be assigned to individual members.

The important thing is to meet regularly and discuss your mutual problems. If each member has a job he is interested in and keeps busy at, morale will stay high and you will really get things done. Without such team work the group members will soon lose interest and become discouraged.

There are a great many ways in which women can be a valuable aid to the group either

as members or associates. Each group should obtain by all means the part time service of one or more secretaries who can type up literature to be printed, articles to the newspapers, communications between groups and so on. Much of the intelligence work can be handled by women. They can assist the propaganda effort by handing out literature, giving talks to women's clubs, PTA associations and so forth.

It is felt that it would be a mistake to set down hard and fast rules for the group's conduct and activities. To do so would run the risk of making each group a carbon copy of every other group and possibly of stifling individual ingenuity. One of the greatest advantages that an underground has is the simple fact that the enemy never knows what he is up against.

The group leader must continually merit the respect and confidence of his members. This respect is the only means he has of maintaining discipline. Before taking any action, all members of the group should have an opportunity to voice their opinions. But it must be mutually understood that when the discussion is over, the group leader must make the final decision. His decision must be complied with and in return for the compliance, he must bear responsibility for the groups ultimate failure or success.

Past experience has shown that the successful underground leader must possess certain minimal qualifications:

1. He must have a strong personal conviction as to the righteousness of the cause for which he is fighting.
2. He must have the ability to infuse other members of his group with this same conviction.
3. He must be able to exercise effective command over his group through personal loyalty and political enthusiasm when no other means of discipline are available.
4. He must be able to keep secrets and organize even quite important actions so that as few people as possible know his plans.
5. He should be a born conspirator, capable of deceiving not only the enemy but even his members of his own group if this is necessary to insure absolute security.
6. He must be able to act inventively and imaginatively so as to constantly seize the initiative away from the enemy.
7. He should have risen to his position of leadership through his own abilities and execution.
8. He should be physically vigorous and self-denying so that he can accommodate himself to primitive surroundings.
9. He should have no addictions or strong habits that might distract him at some crucial moment.

10. He must have the bulldog tenacity to see that important tasks are completed no matter what difficulties or obstacles may be placed in his path.

11. He must have the patience to remain inactive when such is the best course and to wait for exactly the right time to strike.

12. He must have the moral courage to accept full responsibility for his own actions and those of his group.

You should think these requirements over carefully. How do you measure up? It's best if we admit our weak spots to ourselves and start now to strengthen ourselves for the trials ahead. With advance preparation, self-discipline and a firm resolve we can meet the test.

The human race is much inclined to wishful thinking. Even though the communists have told us that they will never rest until they have conquered the whole world, most people will not allow themselves to even consider this possibility. As war clouds gather on the horizon, most people focus their attention all the more on other things and hope that if they just ignore the threat of war it will somehow disappear.

When the time for underground warfare suddenly comes there will be a hundred civilians wanting to fight for every one that is trained or equipped to do so. Under these conditions each member of our organization and similar groups that are making ready for this emergency will surely find himself acting as leader of an underground group. As a part of your self-training it is thus necessary to give some thought as to how you can quickly train new recruits, how you can maintain discipline and security. In short, you must give some serious advance thought as to your own abilities and possible shortcomings as an underground leader.

64

SECRET ARMY ORGANIZATION (SAO)

- (8) SAO UNDERGROUND BULLETIN FOR APRIL, 1972,
WHICH DISCUSSES FORCED ENTRY INTO BUILDINGS
AND USE OF AMMONIUM NITRATE AS AN EXPLOSIVE.

(PAGES 66 - 75)

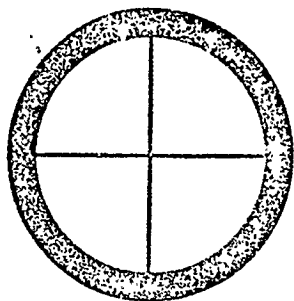

SECRET ARMY ORGANIZATION

UNDERGROUND BULLETIN

GENERAL HEADQUARTERS

APRIL 1972

"A tyrant would not come to the United States from across the sea. If he comes, he'll ride down Pennsylvania Avenue from his inauguration and take up "legal" residence of the White House." Abraham Lincoln

Fellow members,

The main subject that will be covered in this month's bulletin will be the forced entry into buildings, as it applies to underground warfare. A two page article on the use of ammonium nitrate as an explosive is also covered in this bulletin.

We have several points that need to be covered in this bulletin and not much space if we are to keep our postage bill within reason. On the surface, the lives of the American people seem to be going on about the same as usual. So long as most of them have enough to eat and a few luxuries of life, they continue to ignore the undercurrent of treason within our own borders which is rapidly washing away the foundations of our American Heritage.

Those who have taken the time to inform themselves as to the true conditions realize that our country is rapidly reaching a point of no return in its downhill fight against the forces of freedom.

The time is past when the SAO can consider any but a military answer to the problems that face our country. We must act as quickly as we can to develop internal discipline and definite chains of command. If we are going to be a fighting unit, then we must be ready to fight when the time arises.

If we loss those among our organization who are unable to face reality or unwilling to make the sacrifice necessary to add to our strength rather than to detract from it, then the organization as a whole will be better off for it.

New combat teams, groups, and networks will be forming within the next 90 days. Assignment of new members to these new units will be made as soon as they have finished their basic training programs. All teams and groups are urged to expand their local units and keep them active on constructive local projects.

66'

THE USE OF AMMONIUM NITRATE IN HIGH EXPLOSIVES

Ammonium nitrate is a common fertilizer used on farms throughout the United States and most foreign countries. It is readily available from farm agencies, general stores, fertilizer companies, etc. in most farming communities.

Most people know that ammonium nitrate can be used as the basis for various high explosive mixtures. Little information has been available as to the best proportion, uses and means of detonating these mixtures.

Depending on the method of manufacture ammonium nitrate may occur as irregular grains, flakes, small crystals or small round "prills". Any of these types can be used but prilled ammonium nitrate is most efficient. Fortunately, the prilled type is also the most common.

Explosive mixtures may be made by mixing ammonium nitrate with such organic compounds as fuel oil, powdered coal, lamp black, etc. It is quite possible that powdered sugar, starch, and many similar compounds could also be used but further experimentation is needed. Ammonium nitrate itself is extremely difficult to detonate.

The most common and probably the best all round mixture consists of 94% prilled ammonium nitrate and 6% fuel oil. In this case the term fuel oil can include No. 2 diesel fuel, kerosene, light lubricating oil, etc. The only requirements are that it be thin enough to be readily absorbed by the rather porous prills of ammonium nitrate and on the other hand it must not be so volatile as to evaporate easily.

The amount of fuel oil can vary from 2% to 13% and the mixture will still explode provided that a strong detonator is used. Maximum explosive force is achieved between 5% and 6%. These percentages are figured by weight. Presumably the best percentage of lamp black or finely powdered coal would be approximately the same.

Because these mixtures are comparatively insensitive they all require a rather strong explosive to start the detonation. In nearly all cases a one pound stick (2x8 inches) of 60% dynamite will suffice. The dynamite itself must, of course be detonated by a suitable blasting cap. One stick of 40% dynamite does not have enough power to detonate an ammonium nitrate-fuel oil mixture reliably. If this is all that is available, three sticks tied together should be used.

The shape as well as the size of the detonator has an effect. For example, if an eight inch stick of dynamite is cut into four inch pieces and these are tied together it effectively decreases the length and increases the diameter of the detonating charge. This will increase its reliability over that achieved by a single eight inch stick.

67

Several other factors effect the efficiency of AN-FO (ammonium nitrate-fuel oil) mixtures. Among these are the amount of explosive used in a single charge, degree of confinement, moisture content, particle size temperature, etc.

AN-FO mixtures are commonly used in mining rock or ore from large open pits. In this application, holes are drilled back into the rock and the AN-FO mixture is poured into the holes. Normally, the ammonium nitrate and the fuel oil are carried separately to the mine and are mixed together just before they are used. The holes into which the AN-FO mixture is poured are usually several feet long. In this case the diameter of the hole has considerable effect on the explosive force generated. A hole diameter less than three inches will not explode with sufficient force to carry itself along the bore hole. The maximum detonation velocity requires that the bore hole be at least six inches diameter.

In using smaller amounts of AN-FO mixtures the charge should be kept approximately equal in its length, width and depth. In practical application a container about the size of a five gallon gas can is as small as can be used. Charges the size of a 55 gallon drum can provide much more explosive force in proportion to their weight. A small amount of AN-FO requires just as strong a primer to detonate as does a larger amount.

Close confinement is required to achieve maximum explosive force from AN-FO mixtures. In mining operations the rock surrounding the charge provides this confinement. To be exploded above ground the AN-FO mixture should be confined in an iron pipe not less than three inches in diameter and preferably larger. Since these mixtures are "pushing" type explosives rather than "shattering" types they must be properly placed to achieve useful results.

Suppose the objective was to destroy a large bridge. A dozen five gallon cans of AN-FO mixture are available to do the job. If these are set in the middle of the bridge or between the girders and "exploded" little if any real damage will result. In this case, a tunnel should be dug through the dirt behind the concrete abutment at one end of the bridge. Depending on the width of the bridge all twelve cans of explosive could be packed tightly together or they could be spaced three to four feet apart. In either case each can should be provided with its own primer and all the primers should be tied together with two lengths of prima cord.

Moisture content of the ammonium nitrate is very important. This chemical absorbs moisture from the air quite easily. After being mixed with the fuel oil it is protected from this to a considerable extent. For maximum explosive effect the AN-FO mixture should contain no more than 4% water and if the moisture content exceeds 7% it may not explode at all. If it is suspected that the AN-FO mixture may be damp, double the size of the detonater.

For military use, suitable charges could be made from dry ammonium nitrate mixed with the proper amount of fuel oil and then placed in water tight containers. These containers should provide some means of quickly placing the detonater into the approximate center of the charge just before it is to be used. The usual cost of ammonium nitrate is about \$6.00 per 100 pounds.

68

5. If the bolt is exposed and isn't the "deadlocking" type it can be easily worked back into the door with nothing more than a knife blade. Just push or pull the door in the direction of opening thus putting a small amount of force on the bolt. Now insert your knife blade as close to the striker plate as possible. After cutting ever so slightly into the metal latch twist the knife toward the edge of the door, forcing the bolt back into the door. You may have to repeat this procedure several times depending on how far the latch extends into the striker plate.
6. Check the hinge pins. Many doors are installed with cheap hardware. The hinges on outward swinging doors will have easy to remove pins exposed to the outside. All you need here is a pair of good vise grip pliers.
7. Safety chain latches on doors can be undone with a tool shown in fig. 1.
8. Sliding arcadia doors are especially vulnerable to being lifted out of their track at the bottom with a tire tool or large screwdriver.
9. The latch of most key-in-knob door locks extends into the striker plate only about 1/8 in. These doors are easily opened by use of a jimmy bar, tire tool, or by using a small outo jack and a piece of 2x4. There is enough give in the door frames that you can force or jack them apart enough for the latch to clear the striker plate.
10. A lot of doors are constructed with 2 pieces of masonite with random spaced blocks separating them. It is quite easy to cut, saw, or knock a hole in a door like this. Once done you can reach in and have access to the locking mechanism.
11. Window glass is especially vulnerable to being cut or broken. To cut a small opening in a window proceed as follows: Using a glass cutter or a carbide scribe tool scratch a groove around the perimeter of the opening you desire. Completely cover the opening area and beyond the scratch lines by about 2 in. with masking tape. Carefully tap the opening area and along the scratch lines. The glass will probably break into several small pieces all held together by the masking tape. Now carefully peel the tape and broken glass away exposing the opening. With some practice this can be done neatly with little noise. Get an old window frame and practice on it. After cutting the opening you may wish to cover the exposed edges with some more masking tape before reaching through.

69

FORCED ENTRY OF BUILDINGS

In this bulletin we shall study this subject as applicable to underground warfare. In our advanced training lessons we will deal with more specific subjects such as picking, pick guns, key impressioning, etc.

We feel that every guerrilla fighter and every underground member for that matter should at least be familiar with the fundamentals of quickly gaining entry to buildings occupied by the enemy.

Our attention is directed toward the speed and noise of the entry with little regard to the damage done. In later lessons we will deal with the more discreet methods of entry. The 007 type movies and TV have glamorized and distorted the entry of locked buildings the same way they have done weapons and ballistics. It is no more unreal to quickly dial your way through a 4 tumbler combination lock in 30 seconds than it is to fire 250 rds from a BAR after you have loaded it with an 8rd Garand clip. They have done both on TV !

Basically a lock does 2 things. It makes the intruder make noise and expend time. There is no such thing as a buglar proof locking devise or building. Some are just more difficult than others.

LOOK FIRST FOR EASY AND OBVIOUS WAYS OF GAINING ENTRY.

Some examples are given:

1. It is surprising how many people hang an expensive pad lock on either a cheap hasp or a hasp that has been installed with the screws exposed. Only a screwdriver is needed to get through this set-up.
2. First make sure that the lock is actually locked! Don't waste your time forcing an unlocked door! Don't laugh it has been done. Many times people will set the lock but not shut the door hard enough for the latch to drop into the striker plate.
3. One of the quickest ways past a pad lock is with a good pair of bolt cutters. Usually the hasp is the weakest part so cut it instead of the lock. Some locksmiths use a "lock popper" as shown in fig. 4. Such a tool isn't hard to make.
4. Look for unlocked windows - burglars do. As a matter of fact most illegal intry is through an unlocked window.

12. Most notch cylinders are attached to the lock mechanism by 2 screws. By wrenching the cylinder these screws are either bent or broken and the entire body of the cylinder is turned to actuate the mechanism or the cylinder is removed and the lock mechanism is actuated by a screwdriver inserted into the slot where the tail piece of the cylinder was. A large pair of water pump pliers work nicely in most cases. Most cylinders have a stamped sheet metal bezel which can be crushed with the pliers while grabbing the cylinder rim. Sometimes you will find that an attempt has been made to burglar proof a cylinder by replacing the sheet metal bezel with a harden steel one. Of course this will not crush and will also turn without the cylinder. A tool as described in fig. 5 can be employed in such cases.

Use the 2 holes as a drill jig to drill 2 - 3/16 dia holes into the face of the cylinder. Insert the pins in the other end of the tool into the holes in the cylinder and using the tool as a spanner wrench the cylinder can now be turned.

13. Drilling the pins of a cylinder lock is illustrated in fig. 3. Use a 1/8 in. high speed drill bit and drill through the pins at the shear line. After drilling through all the pins (most locks have 5) remove the drill and drive a flat screwdriver into the keyway and turn the cylinder. Sometimes a drilled pin will drop down and block the turning. If this happens just redrill and try again.

We have now covered the more basic and most common ways of forcing entry. All are somewhat crude and make noise to some degree. If your objective is in an isolated area then noise may be of little or no concern. However, most objectives will be in an urban area and noise can be of vital importance. Here is three way to improve the situation somewhat.

1. Develop your techniques and skills. Confidence in yourself will allow you to proceed more surely and consequently more quite.
2. Muffle sounds by various methods. When cutting something with wire cutters or bolt cutters wrap the object being cut with cloth (your handkerchief) or a piece of self sticking foam rubber weather stripping works nicely. If drilling with an electric drill wrap it with foam plastic like used for upholstery. The air cooling is now blocked but for short durations it won't get too hot. Secure the foam with masking tape. This same technique could be applied to any noise emitting tool.

3. Create diversionary noise. An example could be as follows: An automobile has a simulated flat tire or other trouble. The clanging of tools, radio playing, people talking, etc. would create an excellent cover while an accomplice enters an adjacent building. In making diversionary noise don't do any thing that would appear out of the ordinary and attract undue attention.

There are several obstacles that we have purposely omitted up till now. This was done so as to not confuse the actual entry method. These are important and must be considered. There is many but the most common are the following:

1. Dogs - both the noisy kind and the biting kind.
2. Guards
3. Alarm systems.

These all deserve special attention and we mention them here only to bring to light an important point and that is the importance of intelligence or if you will "casing the joint" before hand. If at all possible know as much about your objective as possible. Use any excuse to observe as much of your objective as possible. Door to door canvassing or selling, even go trick or treating with some kids to the front door of your objectives house. You'll get a good look at the front door lock plus a piece of candy.

An old Air Force slogan comes to mind - WHAT YOU DON'T KNOW WON'T HURT YOU - - - IT WILL KILL YOU !

Practice some of the opening techniques (at least the non-destructive ones) on your own home. While visiting friends observe their doors, windows, and locks. For practice try to figure out the best and quickest way to enter it.

The purpose of this bulletin has been to present to every member of the SAC with basic information. Advanced training will be made available to those who have the skill and desire to advance into more sophisticated methods of entry.

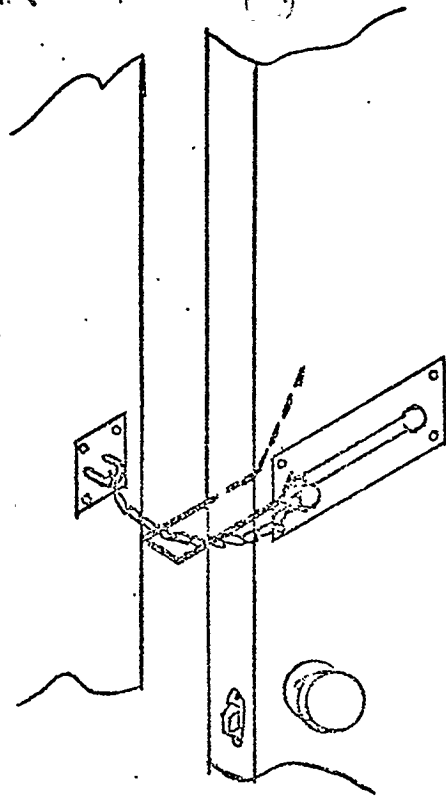

COAT HANGER WIRE

FIG 1

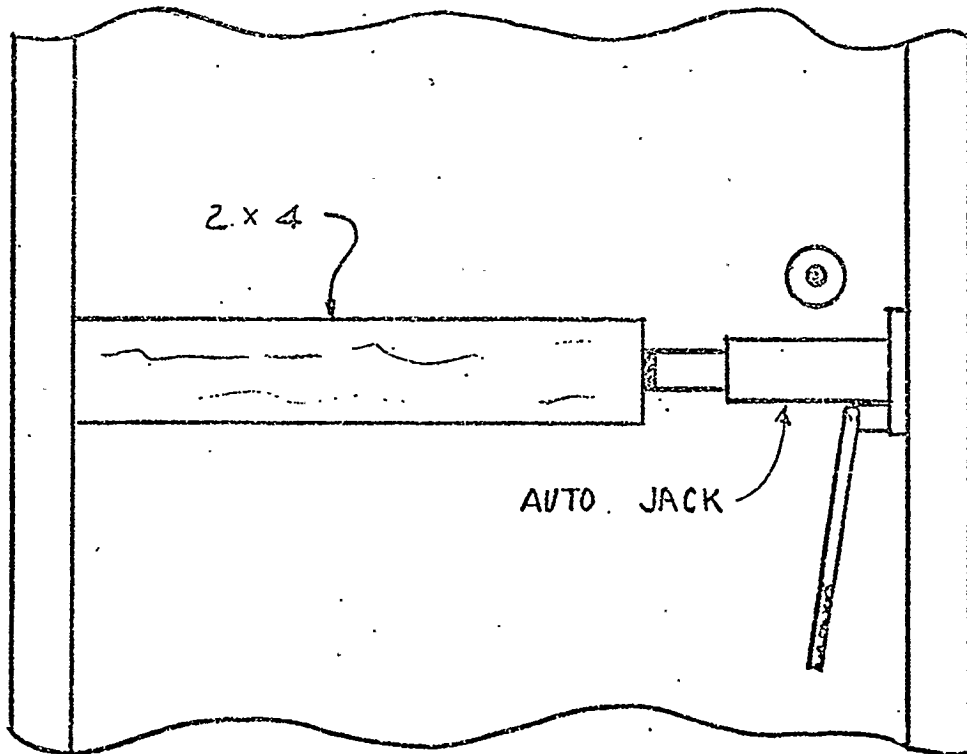

FIG 2

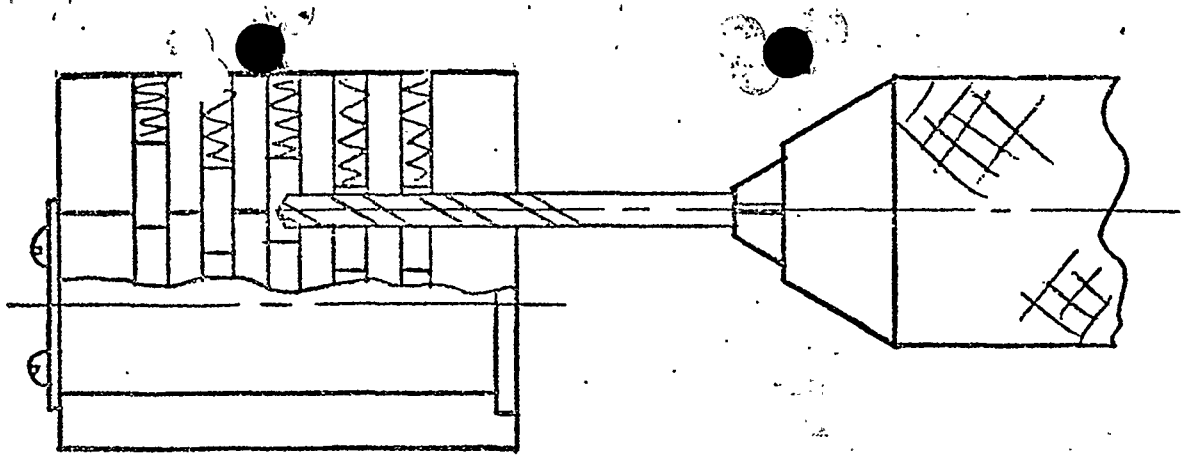

FIG 3

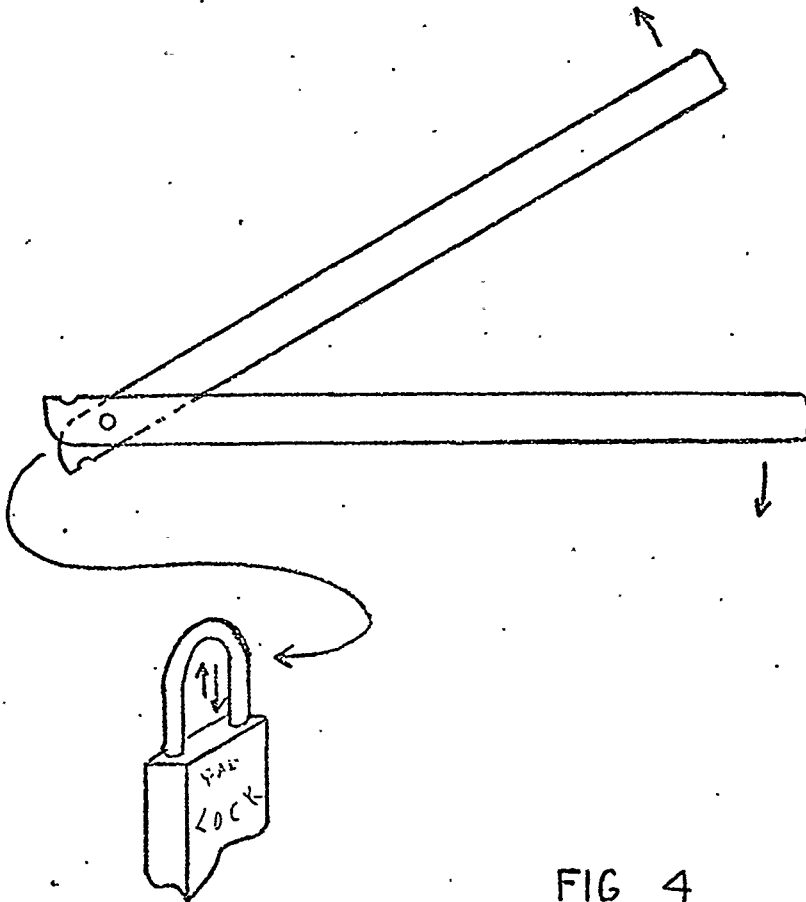

FIG 4

74

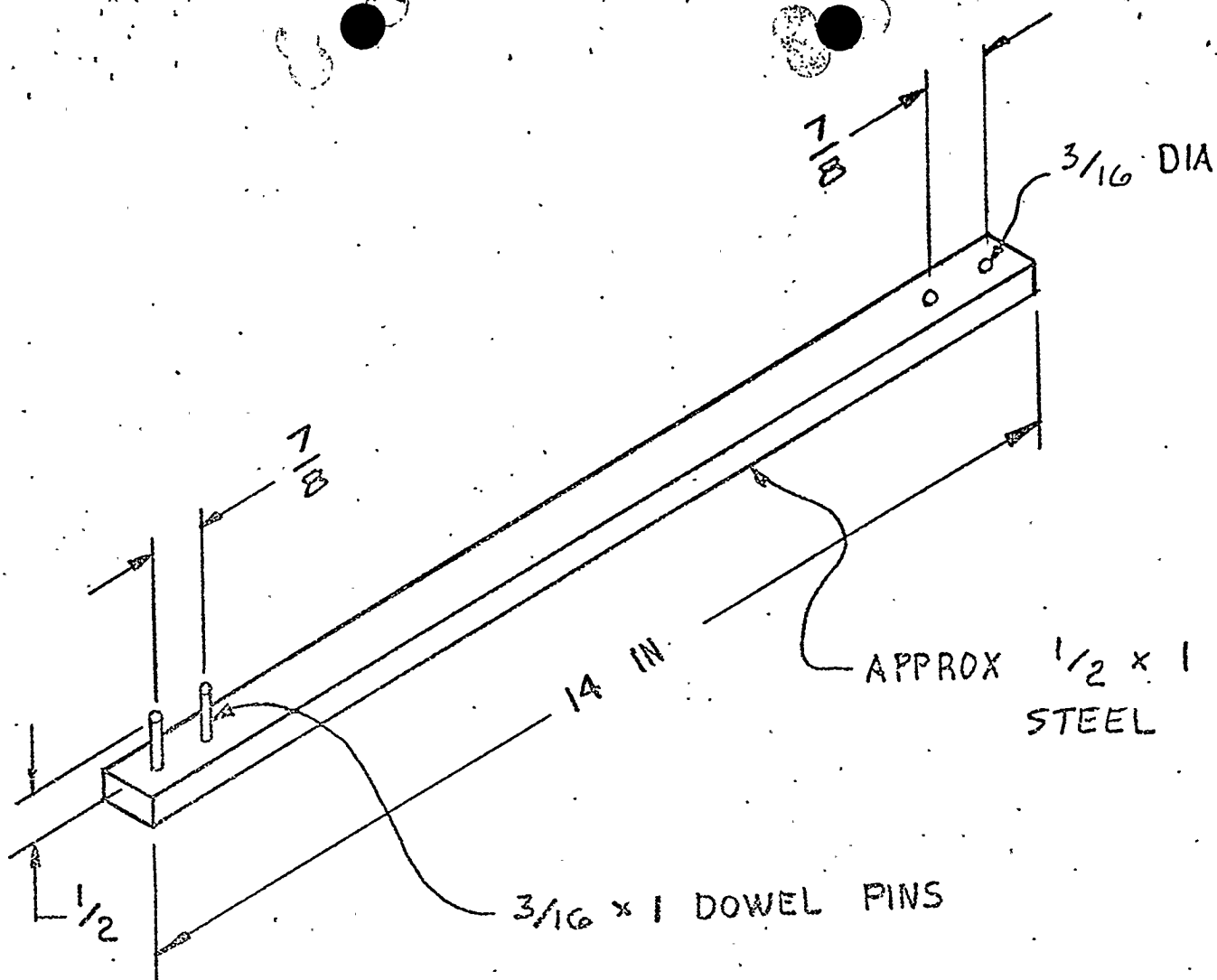

FIG 5

75-

SECRET ARMY ORGANIZATION (SAO)

- (9) SAO UNDERGROUND BULLETIN - JUNE, 1972,
WHICH DISCUSSES HOW TO PREPARE GUNS FOR
STORAGE AND BURYING, AND PRACTICAL
SECURITY MEASURES

(PAGES 77 - 80)

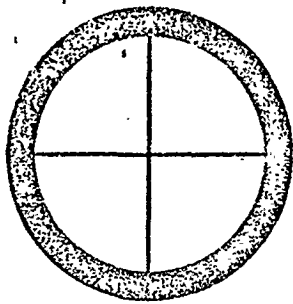

SECRET ARMY ORGANIZATION

UNDERGROUND BULLETIN

GENERAL HEADQUARTERS

JUNE 1972

"The people never give up their liberties but under some delusion". Edmund Burke

Fellow members,

At a recent meeting of the SAO General Staff a very important problem was discussed and the decision to issue a new Organizational Directive made. The problem is that of new members who join our organization and then immediately become totally inactive.

Typically these new members submit a well qualified application form together with their membership fee. Unfortunately, after being accepted as provisional members they never pay a month's dues or send in any report forms. It would really help us to know why some of these people have acted in this way. Did our organization turn out to be something different than they expected? Did they expect a fancy uniform and rifle to be handed to them on a silver platter? Or did they suddenly become afraid to stick their neck out?

Whatever the reasons, it isn't fair to our good members to waste time and money on those who do nothing to help or support the organization. Therefore, effective immediately, the following rules shall apply to such cases as mentioned above.

1. If, three months after submitting an application to the SAO and being accepted as a provisional member, the new member has not begun the basic correspondence training, submitted monthly report forms, paid monthly dues, or provided a reasonable excuse for not having done the above, their file shall be turned over to our Intelligence Section for special attention.
2. If, after six months, the member in question doesn't respond they shall be dropped from our rolls and their names shall be circulated to all members as a potential security risk.

We don't mean to imply that a member can't resign from the Secret Army Organization. However, we do require that a member notify us of their intent and reasons for doing so. If this new Organizational Directive applies to any member in particular let him take notice and govern himself accordingly. GENERAL STAFF - SECRET ARMY ORGANIZATION

Although cosmoline can be purchased in many surplus stores, it may be more practical to make your own from the following directions. One advantage to making your own preparation is that it is much easier to apply while it is in a warm state.

Heat non-bleached petroleum jelly (ember-vaseline) in a small pan or can. Add 30 or 40 weight motor oil to obtain the proper consistency. Using an inexpensive throw-away paint brush as an applicator, brush the warm solution over the weapon. While the solution is still warm it can also be poured into those hard-to-get-at-areas.

One large jar of petroleum jelly and approximately one-half quart of motor oil is sufficient to prepare several weapons.

When the solution has cooled it will set and form a protective coating over the weapon which should then be wrapped in sheet plastic (available in most hardware or paint stores) or in a G. I. plastic gun case (available in most surplus stores). Wrap well and seal with black electrical or plastic tape. It is also wise to enclose a small sack of silicagel crystals to keep the moisture out. These crystals can be purchased at any industrial chemical house or most appliance stores will give them away as they come with cartons of appliances when shipped and they usually have an abundance on supply.

Long guns which cannot be easily torn down can be stored in surplus rocket type boxes readily available in most surplus stores. Try to obtain aluminum or stainless steel containers since they will not tend to rust when buried. 20mm ammunition cans are adequate and a convenient size container for burying smaller weapons and other items. They should be well sealed. The cans should be wrapped in plastic to prevent rust.

Buried containers should have at least one and a half feet of earth over them. One should be careful also in selecting an area to bury material. Areas that could be flooded during even the most unusual weather conditions should be avoided.

Buried containers should be in such a position that they can be found easily and quickly without the use of maps. This can be done by correlation between two or more specific points that will remain in tact, such as trees, large rocks, etc. To assist your memory, paces should be marked off by using the day, month, and year of your birth or that of some family member which you can easily remember.

Another suggestion would be for burying containers along or near roadways which are marked with numbered signs indicating the footage of road per county. These signs are permanent, but it must be remembered that the state has a 500 foot right away on most roads which means the brush may be cleared or the existing road might be widened.

All material which is buried should be checked within three to six weeks for settling or sinking of the ground.

PRACTICAL SECURITY MEASURES

1. Use deceptive measures. Subscribe to one or more left-wing periodicals or get on the mailing list of some "peace movement". This will keep the postal inspectors guessing as to which side you are really on. While doing this our members can be of great assistance in searching this left-wing literature for names and addresses of fellow travelers and forwarding this information for our Central Intelligence files. We desperately need people to assist in this work. Please inquire as to detailed instructions for such activity.

2. Always use two envelopes in sending mail to any patriotic organizations or to any other member of our own organization. Do not put a return address on the outer envelope. Put your return address on the inside envelope with the words, "return postage guaranteed".

3. Place some opaque material such as tin foil, carbon paper, etc. between the inner and outer envelopes to prevent your mail from being read by infra-red cameras.

4. Send all letters from corner mail boxes or from post offices where you are not known.

5. Be careful in the use of the telephone. Avoid telephone calls to known members of the organization as much as possible.

6. Prepare telephone codes ahead of time for future protection.

7. In recruiting new members always learn as much as you can about the prospective recruit and make sure he is not an infiltrator before you identify yourself as a member of the organization.

8. Members of the organization in each area should be divided into four groups:

- A. Those who have been identified publicly or by law enforcement agencies as members of the Secret Army Organization.
- B. Those persons not known as members of this organization but who are generally known as being patriots.
- C. Those persons who have kept their political beliefs hidden.
- D. Members who profess to be liberal for the purpose of infiltrating enemy organizations.

All members should be very careful in making contact with persons in a different category than themselves. For example, people in Class D should be very secret in their contacts and communications with persons of Class A or Class

B. Each member must respect the security of every other member. Do not, under any circumstances, identify one member of the organization to other members without his expressed permission on each and every occasion.

9. Avoid loose talk. Do not discuss organizational plans in public places where you could be overheard. Do not even hint at such a discussion in the presence of non-members.

10. Do not write patriotic letters to newspapers or magazines under your own name. To do so achieves very little except to identify you to the enemy.

11. If you are already known as a patriot, or as a member of this organization you may find it advisable to spread the rumor that you have become disillusioned with the right-wing or for you to pretend a gradual loss of interest.

12. Classify your various members addresses, your communications and your other activities as "top secret", "secret" or "restricted". Use your most secret lines of communication only for the most important messages rather than flooding them with unimportant material.

13. Demand obedience to all security measures from all members. Persistent disregard for security measures should be cause for disciplinary action.

14. Check your lines of communication from time to time by sending phoney messages to make certain they are not intercepted.

15. Change mail drops, meeting places, etc. frequently.

16. Prepare secret rendezvous points, mail drops, etc. now that may be used in time of some future emergency.

17. Each unit should assign some member the rank of Security Officer and should set up a system of fines or other penalties for failure to comply with security precautions.

18. Observe the "need to know" rule. Each member should be given only that information which is needed by him in the performance of his duty or which he will need in cooperating with other members of the unit. No member should feel "left out" because he is denied such information. Instead every member should willingly avoid information which he does not need.

19. Be careful that you are not followed in going to and from meeting places or in making contact with other members of the organization.

20. Keep all records and correspondence carefully hidden and in a manner that they can be easily destroyed. Records should be kept in code whenever possible.

SECRET ARMY ORGANIZATION (SAO)

(10) THE COMBAT TEAM - GENERAL OUTLINE

(PAGES 81 - 83)

THE COMBAT TEAM

General Outline

The "Combat Team" is the smallest organizational unit used by the Secret Army Organization. When organized in the proper manner it is capable of operational initiative when detached from the parent organization. When developed to its highest degree of efficiency the Combat Team is almost totally self-sufficient and able to perform any one of several missions. To attain these aims the following elements are essential:

- a. Equipment should be well-chosen and standardized as much as possible.
- b. Communications, internal and external, must be capable of rapid transmission, be varied in nature, and be exercised with prime emphasis on security.
- c. Internal coordination should be automatic in response. Confidence among members of the team must be developed.
- d. Selection of each position on the team should be based on psychological aspects as well as technical competence.
- e. Training of the men in each function should be at regular intervals and continuous. Field problems should be given dry runs in detail.
- f. The logistics problem should be studied with care, and made simple and direct.
- g. Each team will have a "leader" (Lieutenant) and an "assistant leader" (Sergeant). These men shall be given special training by the Secret Army Organization at "leadership seminars".
- h. Team "marshalling points" should be selected in advance and be well defined. Practice "alerts" will determine the team's efficiency in response and security.
- i. Terrain familiarity within the expected operational radius of the team must be developed.
- j. Weapons familiarity must be obtained through live firings at various targets. Team action must be stressed as well as individual competence.
- k. The team leader should see that a constant flow of information is provided to team members on the ideological struggle. This will help induce the proper frame of mind in each member.
- l. Team missions and targets must be identified and the proper training equipment made available for each assignment.

- m. The team leaders will be responsible for maintaining the overall security of the unit. Personal feelings should not affect decisions involving reprimand or dismissal of men from the team for reasons that endanger its operation or security.
- n. Intelligence gathering as an important part of each team member's duties should be stressed. Information on the location and movements of local communist and left-wing enemies of the organization should be sent to either Regional or General Headquarters.
- o. The team leaders will be responsible for maintaining contact with higher command and for the transmission of orders from same.

ORGANIZATION

The "Combat Team" will consist of six men. These six men will be divided into two sub-teams (Sections). Number One Section will consist of the Team Lieutenant and two other team members. Number Two Section will consist of the Team Sergeant and the two remaining team members. When completely assembled the unit will act directly under the command of the Team Lieutenant. When split into sections the Team Sergeant will carry out the orders of the Team Lieutenant during missions but will be in immediate command of the Number Two Section. In the absence of the Team Lieutenant the Sergeant will take command of the Unit.

TRANSPORTATION

Transportation of the Combat Team will be effected by the use of two carriers. Interception and/or destruction of one carrier will not, then, immobilize the team. In addition, each carrier can serve as a scouting element for the other. Motorized carriers should be as inconspicuous as possible and still serve their purpose. Jeeps and pickup trucks should be used only where such vehicles are owned and used commonly by the general population or where the terrain makes their use necessary. Most often an ordinary passenger car will suffice. The model selected should have a good road clearance so it can be used on dirt roads. Tire chains (if needed), hydraulic jacks, extra gas, water, and suitable tools should be stored in the vehicle.

TRAVEL PROCEDURES

Underway, Carrier #1 will lead and Carrier #2 will trail. The "interval" will vary with conditions. In cities close-aboard trailing will be used. Open road, by day, will require an interval of approximately 300 yards. At night this will be reduced to approximately 100 yards. During travel, all equipment (especially arms and ammunition) should be kept out of sight. Special team equipment and weapons should be locked in the trunk of the vehicle until needed. The trunk key should be carefully hidden so as to make it difficult to search the trunk in case law enforcement agents should stop the car on some pretext with the intention of searching it illegally.

82

WEAPONS AND EQUIPMENT

Selection of weapons and supplies should give the Combat Team maximum flexibility to meet any condition that may be encountered in either rural or urban warfare. Consideration should be given to all possible situations that may develop relating to both traditional guerrilla warfare and modern underground warfare techniques. It should be kept in mind that the Combat Team is a functional part of a resistance network. Its activities should be coordinated with other teams to take maximum advantage of its striking powers.

Disregarding the inclusion of weapons peculiar to a given mission, the standard distribution of men and weapons could be as follows:

- #1 (Team Lieutenant) AR-180 Assault Rifle, automatic pistol, sheath knife, flare gun, and binoculars. 300 rounds of ammunition loaded in clips should be carried for the rifle, plus 50 extra rounds of ammunition for the pistol.
- #2 (Team Member) Riot Shotgun, automatic pistol, sheath knife, and wire cutters (with insulated handles). 100 rounds of No. 4 Buckshot in pouches for the shotgun, and 50 rounds of pistol ammunition.
- #3 (Team Member) AR-180 Assault Rifle, automatic pistol, sheath knife, and smoke grenades or flares. 300 rounds of ammunition in clips for the rifle, and 50 rounds of pistol ammunition.
- #4 (Team Sergeant) AR-180 Assault Rifle, automatic pistol, sheath knife, flare gun, and binoculars. Ammunition requirement is the same as #1 man.
- #5 (Team Member) M1903 Springfield Rifle with sniper scope, automatic pistol, sheath knife, and entrenching shovel. 100 rounds of AP ammunition in bandoleers for the rifle, and 50 rounds of pistol ammunition.
- #6 (Team Member) AR-180 Assault Rifle, automatic pistol, sheath knife, and 30 feet of climbing rope with grappling hook. Ammunition requirement is the same as #1 man.

ADDITIONAL MATERIAL

In addition to the weapons and supplies already listed each team member should have the following basic equipment:

- a. Sleeping bag and waterproof ground cloth
- b. Canteen (1 quart army type)
- c. Survival rations for three days
- d. First aid kit
- e. Gas mask with extra filter
- f. Flashlight with extra batteries
- g. Fatigue or camouflage clothing
- h. Combat or paratrooper boots

SECRET ARMY ORGANIZATION

SECRET ARMY ORGANIZATION (SAO)

(11) SECRET RECIPES - BOMBS

(PAGE 85)
& 85a

SECRET RECIPES

HOME-MADE EXPEDIENTS

CHERRY BOMB

12 powders from cherry bombs
1 fuse from cherry bomb
one snuff can 2" high and 1" across
about 50 bebes

After powder and bebes are in can, put lid on. Take ice pick, punch hole in top of lid. Slip fuse in. Then cover can completely with airplane glue around the base of the fuse to hold in place better when thrown.

PLASTIC

Potassium Chlorate
Petroleum Jelly (Vaseline)
A round wooden stick or rolling pin

Spread the Potassium Chlorate thinly on a hard surface. Roll the round stick (rolling pin) over the crystals to crush them into a very fine powder (until it looks like face powder). Take 9 parts of the powdered Potassium Chlorate and one part of vaseline, and knead them together until a uniform paste is obtained. Detonate with a blasting cap or with a .30 caliber fused blank.

BLACK POWDER

Potassium Nitrate - 25 parts
Charcoal - 3 parts
Sulphur - 2 parts

Dissolve the Potassium Nitrate in an equal amount of water. Pulverize the charcoal and sulphur, and add the Potassium Nitrate solution to obtain a thoroughly wet paste. Allow to dry.

FAST BURNING FUSE

Twist soft cotten string into three strands. Moisten black powder to form a paste and rub the paste into the twisted string. Burns 30 to 40 inches per minute.

SLOW BURNING FUSE

Dissolve one part of Potassium Nitrate or Potassium Chlorate and one part of sugar (granulated) in two parts of hot water. Soak the string in this solution. Twist the string into three strands and allow to dry. Burns about 2 inches per minute.

FUSES

Fuses can be made by soaking course paper in a solution of gun powder and acetone (nail polish remover) overnight, then drying. Cut strips and twist together. Also, by coating a cotton string with a sticky substance, then dipping into gunpowder, coating all surfaces. A time delay fuse that can be used without a match is made as follows: Make a small pile of potassium permanganate and make a small pile of it on the ground, making a hole in the center of it. Next pour in the hole about an equal amount of straight glycerine. A flash will occur in about one minute. This method is best used when gun powder has to be used as a fuse... or for starting fires.

PACKAGE BOMB

mouse trap
electrical wire
box or package

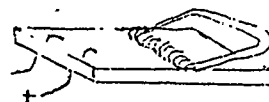
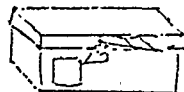

The mouse trap is the trigger. When the box is opened, the trap will close and contact on two electrical wires.

85

JELLIED GASOLINE

Pour the contents of one bottle (1 pint 3 oz.) of Dynamo concentrated liquid laundry detergent into a bucket or large mouthed can of about two to five gallon size. Fill the detergent bottle twice, shaking well to rinse it out with gasoline (any grade) and add it to the detergent. You will now have about 3 1/2 pints (57 oz) of material in the bucket. The detergent will be at the bottom and the gasoline on the top. Stir this rapidly with a wooden or wire paddle so as to mix in as much air as possible. Soon the mixture will take on the appearance of soft vasoline.

Now add in a gallon of gasoline and stir again until the mixture thickens. At this point, transfer the mixture to clean containers. No return type beer and soda bottles are ideal. For chemical land mines, use two gallon oil cans. The container should be filled approximately one third full of the mixture. Finish filling the container with gasoline leaving a little air space at the top. Place your finger or hand over the opening and shake well until the gasoline and mixture amalgamate. You can verify this by looking at the finger or hand occasionally to see if a film of jellied gasoline about an eighth of an inch thick clings to it. When proper consistency is reached, the bottles may be capped or corked. Cans should have tight fitting lids screwed on. This may be stored up to two weeks. Tie a rag around the neck of each bottle being careful not to leave the ends of the rag too long or too loose.

If necessary, this mixture can be "cut" 50% with gasoline or other petroleum product. The tendency to "cling" will suffer slightly, but consistency can be maintained by pouring off the excess gasoline whenever the detergent refuses to "take" any more.

To use, saturate the rag with gasoline or the mixture from the bottle. Keep the flammable material off of your person and clothing. Light the rag with match or cigarette lighter and immediately serve. Throw hard against a solid object such as masonry, concrete, or metal. In using the mixture in a chemical land mine, wrap three or four wraps of primacord around a two gallon can and tie the primacord under the can around a pound of explosive. This may be exploded either electrically or by a percussion such as a booby trap device or anti-personnel fuse. Do not contact wires to the blasting machine until after you have carefully removed all traces of your work and camouflaged the position. Never use any plastic article in contact with the above mixture.

ARMOUR PIERCING BULLETS

Reloaders can drop a 25 caliber steel ball bearing into a .30 caliber bullet mould and thus have an armour piercing bullet. It is also a duplex bullet as the ball bearing will keep going after the lead has stopped.

SHRAPNEL MINE

Length of stove pipe
nuts, bolts, buck shot, etc.
wood
dynamite
fuse

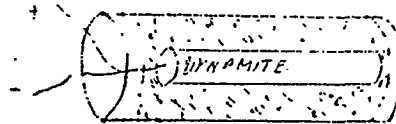

Block both ends of the stove pipe with wood after the stick of dynamite has been placed in the center and the nuts, bolts, and other shrapnel material has been placed around the dynamite. Hang from a tree.

NOTES:

85a

SECRET ARMY ORGANIZATION (SAO)

BECAUSE OF THEIR PROPENSITY FOR COLLECTING FIRE-
ARMS AND HAZARDOUS EXPLOSIVES, ALL MEMBERS OF THE SECRET
ARMY ORGANIZATION SHOULD BE CONSIDERED ARMED AND DANGEROUS.

This document contains neither recommendations nor conclusions of the FBI. It is the property of the FBI and is loaned to your agency; it and its contents are not to be distributed outside your agency.

Mr. Tolson	_____
Mr. Baker	_____
Mr. Bates	_____
Mr. Bishop	_____
Mr. Callahan	_____
Mr. Conrad	_____
Mr. Dalbey	_____
Mr. Jenkins	_____
Mr. Marshall	_____
Mr. Miller	_____
Mr. Ponder	_____
Mr. Soyars	_____
Mr. Walters	_____
Tele. Room	_____
Mr. Kinley	_____
Mr. Armstrong	_____
Ms. Herwig	_____
Mrs. Neenan	_____

1030PM NITEL 9-1-72

SEP 2 1972

TO: ACTING DIRECTOR (157-23577) (ATTENTION D I D)

TELETYPE

FROM: SAN DIEGO (157-2815)

SECRET ARMY ORGANIZATION (SAO); EXTREMIST MATTERS.

RE SAN DIEGO NITEL AUGUST TWENTYONE LAST.

Handwritten initials and scribbles

THE HEARING IN SAN DIEGO COUNTY SUPERIOR COURT, BEFORE

HONORABLE GILBERT HARELSON IN THE CASES INVOLVING YAKOPEC, HOOVER AND MR. AND MRS. FLEURY IN CONNECTION WITH THE SEARCH WARRANT AFFIDAVIT IS NOW UNDER WAY. SA EARL M. PETERSEN DID NOT TESTIFY ON THIS DATE AND IS ON STANDBY FOR POSSIBLE TESTIMONY ON SEPTEMBER FIFTH NEXT. DEPUTY DISTRICT ATTORNEY BRIAN MICHAELS, FORMERLY AUSA SAN DIEGO, HAS ADVISED THAT SA PETERSEN WILL PROBABLY NOT TESTIFY UNLESS JUDGE HARELSON CHANGES HIS MIND FROM PRESENT ATTITUDE.

9

TODAY DURING THE HEARING A MOTION WAS MADE TO CONTINUE THE TRAIL OF GEORGE MITCHELL ^{CALIF} HOOVER FROM SEPTEMBER SEVENTH NEXT TO OCTOBER TWENTYFIFTH NEXT. AT THE REQUEST OF DEPUTY DISTRICT ATTORNEY JOHN A. HEWICKER, II, SAN DIEGO COUNTY, THE TRIAL WAS LEFT ON THE CALENDER FOR SEPTEMBER SEVENTH IN ORDER THAT WITNESSES CAN APPEAR ON THAT DATE AND CAN BE INSTRUCTED TO APPEAR ON OCTOBER TWENTYFIFTH NEXT. THIS BEING DONE TO AVOID SERVING OF NEW SUBPOENAS.

Handwritten letter 'A'

EX-116

REC-33

157-23577-47

MICHAELS HAS ADVISED THAT FORMER SA STEVEN L. CHRISTENSEN WILL NOT APPEAR UNTIL OCTOBER TWENTYFIVE AND THAT HE HAS BEEN SO ADVISED THROUGH HIS ATTORNEY KEVIN MCINERNEY OF SAN DIEGO.

SEP 6 1972

PENDING

1- ISD, Kevin T. McInerney carried By WCP 9/5/72 Admin del. lat.

Handwritten signature: 5- Patton

END

Assistant Attorney General
Internal Security Division

September 5, 1972

Acting Director, FBI

- 1 - Mr. D. W. Dalbey
- 1 - Mr. W. C. Patterson

SECRET ARMY ORGANIZATION
EXTREMIST MATTERS

This is to confirm that on August 30, 1972, Kevin T. Maroney, Deputy Assistant Attorney General, Internal Security Division, advised Special Agents William C. Patterson and James L. Williamson of this Bureau that authority was granted for Special Agent Earl M. Petersen to testify in Superior Court, San Diego County, San Diego, California, as a witness in the trial of William Francis Yakopec, which begins September 6, 1972.

Mr. Maroney was made aware of the proposed questions to be asked by the prosecution and the answers of Special Agent Petersen. These concern Special Agent Petersen's relationship with former Bureau informant Howard Barry Godfrey. Mr. Maroney authorized Special Agent Petersen's testimony in line with the above. If Special Agent Petersen is questioned concerning other than as discussed, he is to advise that in accordance with Code of Federal Regulations, Title 28, Section 16.12, such information acquired while in the performance of official duties as a Special Agent of the FBI cannot be disclosed unless approved by the Attorney General. Additional information required is to be identified and furnished the Department in order that consideration can be given as to whether such information is to be disclosed.

157-23577

SEP 5 - 1972
(157-2815)

2 - San Diego

NOTE FOR SAC, SAN DIEGO:

ReSDtef 8/29/72.

This will confirm that authority has been obtained for the appearance of SA Earl M. Petersen in Superior Court, San Diego County, San Diego, California, as outlined in this letter.

1 - Personnel File of SA Earl M. Petersen

WCP:aso (8)

SEE NOTE PAGE TWO

MAIL ROOM TELETYPE UNIT

- elt _____
- taker _____
- lates _____
- fishop _____
- allaham _____
- leveland _____
- onrad _____
- albey _____
- enkins _____
- farshall _____
- filler, E.S. _____
- onder _____
- oyars _____
- alters _____
- fele. Room _____
- tr. Kinley _____
- fr. Armstrong _____
- Horwitz _____
- Neehan _____

SEP 11 1972

EX-103
REC-71 157-23577-46
SEP 1 10 52 AM '72
19 SEP 6 1972
GCM

Assistant Attorney General
Internal Security Division

NOTE:

William Francis Yakopec, a member of the paramilitary, ultraconservative, anticommunist Secret Army Organization (SAO), was identified by former Bureau informant Howard Barry Godfrey as the individual responsible for the bombing of a San Diego, California, movie theater on 6/19/72. This information was furnished the San Diego Police Department (SDPD). On the basis of information furnished, Yakopec was arrested on 6/26/72 and charged with attempted murder and possession and improper storage of gunpowder in excess of 20 pounds without a license. The informant Godfrey was turned over to the SDPD in order that prosecution could be undertaken of Yakopec and other SAO members who have been arrested on the basis of information furnished by Godfrey. SA Petersen was the alternate Agent contacting Godfrey for the past two and one-half years and was assigned this informant since 7/6/72. This matter has been coordinated with SA James L. Williamson, Office of Legal Counsel.

FBI

Date: 8/28/72

Transmit the following in _____
(Type in plaintext or code)

Via AIRTEL _____
(Priority)

TO: ACTING DIRECTOR, FBI (157-23577)

FROM: SAC, SAN DIEGO (157-2815) (P)

SECRET ARMY ORGANIZATION (SAO)
EXTREMIST MATTERS

Handwritten: ycm / 14

Re San Diego teletypes 8/21 and 23/72; and San Diego airtel 8/24/72.

The hearing for 8/25/72, for which SA EARL M. PETERSEN was subpoenaed has been continued to 2:00 PM, 9/1/72. Deputy District Attorney JOHN A. HEWICKER, II, San Diego County, advised on 8/25/72, that Defense Attorneys for WILLIAM FRANCIS YAKOPEC and JERRY LYNN DAVIS have now joined with the defense for GEORGE MITCHELL HOOVER in this hearing. Deputy District Attorney BRIAN EDWARD MICHAELS, formerly AUSA, San Diego, advised SA PETERSEN on 8/25/72, that he will attempt to confine testimony at the hearing to the search warrant affiant, Detective RUBEN BRANDON, San Diego Police Department. He stated that the judge hearing the case might order SA PETERSEN to testify over the DA's objections. SA PETERSEN will be available for testimony during the hearing, UACB, as previously advised.

The following additional subpoenas have been received by Agents of the San Diego Office:

- 2 - Bureau
- 5 - San Diego (2 - 157-2815) (SAO)
 - (1 - 157-3017 HOOVER)
 - (1 - 157-1820 YAKOPEC)
 - (1 - 157-3001 DAVIS)

REC-23
EX-114

AUG 31 1972

EMP:ejt
(7)

Handwritten: P...
EXT. INT. SEC.

80 SEP 11 1972

Approved: _____ Sent _____ M Per _____

Special Agent in Charge

SD 157-2815

SA EARL M. PETERSEN for testimony for the prosecution on 9/6/72 in the trial of WILLIAM FRANCIS YAKOPEC.

SA JORDAN C. NAYLOR and SA PETERSEN for testimony for the prosecution in the trial of GEORGE MITCHELL HOOVER on 9/7/72. It is noted that former SA STEVEN L. CHRISTENSEN has been requested to appear for the prosecution on 9/7/72.

SA PETERSEN for testimony for the prosecution at the trial of JERRY LYNN DAVIS on 9/13/72.

San Diego will forward to the Bureau a list of questions to be asked by the prosecution in each of the trials named above. These questions and the answers to be given by the Agents subpoenaed will be forwarded to the Bureau as soon as available in order that approval of the Justice Department can be obtained.

San Diego will maintain contact with the United States Attorney's Office in San Diego regarding the above described testimony.

Superior Court of the State of California
FOR THE COUNTY OF SAN DIEGO

No. 26844

The People of the State of California,
Plaintiff

vs.

WILLIAM FRANCIS YAROPEC

Defendant

(SPACE BELOW FOR FILE STAMP)

SUBPENA DUCES TECUM
(Criminal)

THE PEOPLE OF THE STATE OF CALIFORNIA TO: EARL PETERSEN

You are commanded to appear before the Honorable ROBERT W. CONVERS
a Judge of the Superior Court of the State of California, in the County of San Diego, in Department
12, of said Court, at the County Courthouse, 220 West Broadway, San Diego,
California, on _____, at 10:00 AM., as a witness in a criminal action
prosecuted by the People of the State of California against the above named defendant.

YOU ARE FURTHER REQUIRED to bring with you and produce, at said time and place, the
books, papers and documents or other things in your possession or under your control, described _____

== see declaration ==

(In the attached declaration/affidavit in support of subpoena duces tecum, reference to which is made in exhibit "A"
attached hereto/as follows: (describe books, etc., intelligibly)).

Disobedience to this subpoena, or a refusal to be sworn or to testify as a witness, may be pun-
ished as a contempt by the above entitled Court. A witness disobeying a subpoena issued on the part
of the defendant, unless he show good cause for his nonattendance, is liable to the defendant in the
sum of one hundred dollars.

By Order of the Court:

(SEAL)
SUPERIOR COURT

September 14, 1972

Jesse Osuna (DATE)
XBARBIANES, Clerk

By: Clarinda Benson Deputy Clerk

*Received
9/18/72 from
S. W. Diego
by telecopy
WJP*

SUBPENA DUCES TECUM (Criminal)

(Penal Code Sec. 1327, 1328)

157-23577
file
5-WJP

157-23577-

Superior Court of the State of California
FOR THE COUNTY OF SAN DIEGO

No. 26844

THE PEOPLE OF THE STATE OF
CALIFORNIA

Plaintiff...

vs.

WILLIAM FRANCIS YAKOPEC

Defendant...

DECLARATION FOR SUBPENA DUCES TECUM

FREDERICK HETTER

declares:

That he is attorney of record for ~~plaintiff~~ defendant in the above entitled action; that said cause has been duly set down for trial on September, 1972 at 10:00am, in Department 12 of the above entitled court.

Affiant alleges that EARL PETERSEN, Special Agent, F.B.I., 3211 Fifth Avenue

has in his possession or under his control the following documents, matters, or things:
(Designate and specify the exact matters or things to be produced)

All records, notes, reports, and other material regarding HOWARD BERRY GODFREY'S employment as an F.B.I. informant, including, but not limited to, his initial application and letter of resignation.

Affiant states that the above documents, matters, and things are material to the proper presentation of his case and that good cause exists for the production of the above-described matters and things for the following reasons:
(State in full detail the materiality to the issues involved)

Said document will be used to prove certain allegations of defendant, and disprove certain expected allegations of plaintiff.

WHEREFORE affiant prays that Subpena Duces Tecum issue.
I declare under penalty of perjury that the foregoing is true and correct.

Executed on September 14, 1972 at San Diego, California, California.

(Sign here)
FREDERICK HETTER

DECLARATION FOR SUBPENA DUCES TECUM

FBI

Date: 8/24/72

Transmit the following in _____
(Type in plaintext or code)

Via AIRTEL _____
(Priority)

TO: ACTING DIRECTOR, FBI (157-23577)
FROM: SAC, SAN DIEGO (157-2815)(P)
RE: ⁰SECRET ARMY ORGANIZATION (SAO)
EXTREMIST MATTERS

9/24/72
5/49

JWS
M

GEORGE MITCHELL HOOVER has been scheduled for trial in the Superior Court of the State of California in and for the County of San Diego, on 9/7/72, on charges of Attempted Murder. This charge involves the shooting of PAULA THARP who was a guest in the home of radical Professor PETER BOHMER.

Assistant District Attorney JOHN A. HEWICKER, II, San Diego County, advised on 8/24/72, that he has directed a "Memorandum Subpoena" to former SA STEVEN L. CHRISTENSEN at Post Office Box 2, Kanosh, Utah, requesting that he appear in San Diego on 9/7/72, at 9:00 a.m., as a witness for the prosecution in this trial. Mr. HEWICKER explained that CHRISTENSEN could not be subpoenaed by the court to appear inasmuch as he is living outside the State of California.

Mr. HEWICKER advised that he has received the following letter from CHRISTENSEN:

NOT

- ② - Bureau (RM)
- 3 - San Diego
- (1 - 157-3017)

DAW 3

EMP/gar
(5)

REC-471 157-23577-44

4 AUG 28 1972

56 SEP 8 1972

Approved: _____

Sent _____ Per _____

Special Agent in Charge

U.S. Government Printing Office: 1972-455-574

SD 157-2815

"Kanosh, Utah
August 15, 1972

"John A. Hewicker II
"Deputy District Attorney
"County of San Diego

"Dear Sir:

"I have received your letter of August 10, 1972. As regarded in your letter, I will testify. However, I do so reluctantly for several reasons. First, I am in an extremely critical financial situation and my time and presence in this area are of utmost importance to me in getting re-established. Furthermore, I am not happy about the prospect of having my identity and location generally known. As you are probably well aware, several close associates of members of the Secret Army Organization live within a few miles of me. This situation has caused my wife to become extremely distraught, and she refuses to remain here alone with the children without adequate protection. Needless to say, I am not presently financially able to take my family on a lengthy or time consuming trip. Another thing to be considered is that school begins here on August 23rd and my children would need to be here to enroll and attend classes.

"It has also occurred to me that, as in the Grand Jury proceedings, it will be unlawful for me to testify without prior clearance from the U. S. Attorney General's Office. Your letter did not indicate whether this had already been taken care of.

"And then there is the problem of my testimony itself. It would possibly implicate me in violation of the law, and I do not wish to spend even a part of my life being concerned with such a prospect.

"There are also other questions, such as anticipated date of testimony, length of stay, and whether my return would be required for subsequent trials.

SD 157-2315

"My telephone number is 759-2401.

"Respectfully,

"S/STEVEN L. CHRISTENSEN
P.O. Box 2
Kanosh, Utah

With regard to questions asked by CHRISTENSEN in his letter, HEWICKER stated that he has conferred with CHRISTENSEN's attorney KEVIN MC INERNEY regarding the question of possibly furnishing immunity to CHRISTENSEN for his testimony. He advised that CHRISTENSEN will not be granted immunity and he has advised MC INERNEY that he and former SA CHRISTENSEN will have to rely on his word that no action will be taken to charge CHRISTENSEN as a result of any testimony that he might give. CHRISTENSEN's expenses including his transportation to San Diego and his expenses while in San Diego will be paid by the County. No action will be taken by the County to transport Mrs. CHRISTENSEN or their children to San Diego or to provide protection for them in Utah during the course of the trial.

CHRISTENSEN will probably be needed for approximately one week, beginning 9/7/72, inasmuch as HEWICKER feels that CHRISTENSEN will be needed for rebuttal testimony.

Mr. HEWICKER is preparing a set of questions which the prosecution will ask CHRISTENSEN during direct testimony during this trial. These questions will be furnished to the San Diego Office, possibly on 8/25/72, for transmittal to the Bureau and to the Justice Department.

Assistant United States Attorney (AUSA) ROBERT H. FILSINGER will be furnished a set of the questions which will be asked former SA CHRISTENSEN and the Bureau will be advised of any comments he might have concerning CHRISTENSEN's testimony in this case.

FEDERAL BUREAU OF INVESTIGATION
COMMUNICATIONS SECTION

AUG 23 1972

NR 09 SD PLAIN

8:35 PM URGENT 8-23-72 LLC

TELETYPE

TO ACTING DIRECTOR (157-23577) (ATTN: D I D)
FROM SAN DIEGO (157-2815) 2P

G.C. Anderson

Mr. Felt	_____
Mr. Baker	_____
Mr. Bates	_____
Mr. Elshoff	_____
Mr. Callahan	_____
Mr. Cleveland	_____
Mr. Conrad	_____
Mr. Dalbey	_____
Mr. Jenkins	_____
Mr. Marshall	_____
Mr. Miller, E.S.	_____
Mr. Ponder	_____
Mr. Soyars	_____
Mr. Walters	_____
Tele. Room	_____
Mr. Kinley	_____
Mr. Armstrong	_____
Ms. Herwig	_____
Mrs. Neenan	_____

CRW

SECRET ARMY ORGANIZATION (SAO), EXTREMIST MATTERS.

RESDTL AUGUST TWENTYONE LAST.

AUSA ROBERT FILSINGER HAS ADVISED SA EARL M. PETERSEN THAT LEIF TESSEM, ESQUIRE, DEFENDER'S INCORPORATED WHO HAS BEEN APPOINTED TO REPRESENT DEFENDANT HOOVER HAS INDICATED THAT QUESTIONS DIRECTED TO SA PETERSEN ON AUGUST TWENTYFIVE NEXT WILL BE IN CONNECTION WITH THE CREDIBILITY OF THE INFORMANT AND AS TO THE ACCURACY OF THE FACTS CONTAINED IN AN AFFIDAVIT FOR SEARCH WARRANT FILED ON JUNE TWENTYSIX, NINETEEN SEVENTYTWO, BY OFFICER RUBIEN BRANDON OF THE SAN DIEGO POLICE DEPARTMENT (SDPD).

Hulgan

S.W. Peterson

3

AUSA FILSINGER IS AGREEABLE TO TESTIMONY BY SA PETERSEN AS TO FACT THAT INFORMANT HAS FURNISHED RELIABLE INFORMATION IN THE PAST AND THAT FACTS CONTAINED IN THE AFFIDAVIT ARE ACCURATE. THE AFFIDAVIT IS LARGELY BASED UPON INFORMATION FURNISHED BY HOWARD BARRY GODFREY RELAYED TO OFFICE BRANDON BY SA PETERSEN.

REC-65

157-23577 43

EO AUG 30 1972

END PAGE ONE

103
58 SEP 1 1972

PAGE TWO

SD 157-2815

AUSA FILSINGER OR OTHER AUSA WILL ACCOMPANY SA PETERSEN TO THE HEARING ON AUGUST TWENTY FIVE.

SHOULD SA PETERSEN BE ASKED QUESTIONS OTHER THAN THOSE AS STATED ABOVE, HE WILL ADVISED THAT IN ACCORDANCE WITH THE CODE OF FEDERAL REGULATIONS, TITLE TWENTYEIGHT, SECTION ONE SIX ONE TWO, SUCH INFORMATION ACQUIRED WHILE IN THE PERFORMANCE OF HIS OFFICIAL DUTIES AS A SPECIAL AGENT OF THE FBI CANNOT BE DISCLOSED UNLESS APPROVED BY THE ATTORNEY GENERAL.

HACB SA PETERSEN WILL APPEAR AND TESTIFY AS DESCRIBED ABOVE.

P

END

ICC - ISD
ATTN: Dept AAS Kevin Mahoney

cc - MR. TRAINOR
ROOM 712-A 9&D

EX-104

Assistant Attorney General
Internal Security Division ^{REC-65}

August 28, 1972

Acting Director, FBI 157-23577-42

SECRET ARMY ORGANIZATION
EXTREMIST MATTERS

- 1 - Mr. D. W. Dalbey
- 1 - Mr. H. N. Bassett
- 1 - Mr. W. C. Patterson

This is to confirm that on August 24, 1972, Kevin T. Maroney, Deputy Assistant Attorney General, Internal Security Division, advised Special Agent William C. Patterson of this Bureau that authority was granted for Special Agents Earl M. Petersen and C. Jordan Naylor to testify in Superior Court, San Diego County, San Diego, California, as witnesses in a criminal action against George M. Hoover.

Testimony is to be restricted to answering questions regarding the credibility of former Bureau informant Howard Barry Godfrey and the accuracy of information supplied the San Diego Police Department by Special Agent Petersen, that he received from the informant Godfrey, and which was contained in an affidavit for a search warrant filed on June 26, 1972, by an officer of the San Diego Police Department. If the above Agents are questioned concerning other than the above, they will advise that in accordance with Code of Federal Regulations, Title 28, Section 16.12, such information acquired while in the performance of official duties as Special Agents of the FBI cannot be disclosed unless approved by the Attorney General. Additional information required is to be identified and furnished the Department in order that consideration can be given as to whether such information is to be disclosed.

MAILED 5
AUG 28 1972

157-23577
2 - San Diego (157-2815)

SEE NOTE FOR SAC, SAN DIEGO
PAGE TWO

- Felt _____
- Baker _____
- Bates _____
- Bishop _____
- Callahan _____
- Cleveland _____
- Conrad _____
- Dalbey _____
- Jenkins _____
- Marshall _____
- Miller, E.S. _____
- Ponder _____
- Soyars _____
- Walters _____
- Tele. Room _____
- Mr. Kinley _____
- Mr. Armstrong _____
- Ms. Herwig _____
- Mrs. Neenan _____

- 1 - Personnel File of SA Earl M. Petersen
- 1 - Personnel File of SA C. Jordan Naylor

WCP:aso (10)

SEE NOTE PAGE TWO

58 SEP 1 1972

MAIL ROOM TELETYPE UNIT

ms
cas
mk
WGC
GCM
HHH
DJD
WCP

Assistant Attorney General
Internal Security Division

NOTE FOR SAC, SAN DIEGO:

ReSDtels 8/21 and 8/23/72.

This will confirm that authority has been obtained for the appearance of Special Agents C. Jordan Naylor and Earl M. Petersen in Superior Court, San Diego County, San Diego, California. Bureau is to be kept advised regarding progress of prosecutive action in this matter.

NOTE:

George M. Hoover, a member of the paramilitary, ultra-conservative, anticommunist Secret Army Organization (SAO), was identified by former Bureau informant Howard Barry Godfrey as the individual responsible for the wounding by shooting of Paula Tharp on 1/6/72 in San Diego, California. This information was furnished the San Diego Police Department (SDPD). On the basis of information furnished by the informant, Hoover was arrested on 6/26/72 by the SDPD and charged with attempted murder and improper storage of gunpowder in excess of 20 pounds without a license. The San Diego Division has advised that a search warrant was obtained by the SDPD based on information furnished by the informant. Special Agents C. Jordan Naylor and Earl M. Petersen have been subpoenaed to appear as indicated above as witnesses. Special Agent Naylor originally opened an informant case regarding the informant Godfrey but has not contacted Godfrey in past five years. Special Agent Petersen has been the alternate Agent contacting Godfrey for the past two and one half years and was assigned this informant since 7/6/72. This matter has been coordinated with Inspector John A. Mintz, Office of Legal Counsel.

Domestic Intelligence Division

INFORMATIVE NOTE

Date 8/22/72

Special Agents C. Jordan Naylor and Earl M. Peterson of San Diego FBI Office have been subpoenaed to appear in Superior Court, San Diego County, California, on 8/25/72, as witnesses in a pending criminal action against George Hoover, a member of the extremist, paramilitary Secret Army Organization (SAO).

The defense has subpoenaed Special Agents indicating intention to attack credibility of former Bureau informant who furnished information incriminating defendant Hoover. Hoover being tried for shooting of Paula Tharp on 1/6/72.

Assistant U.S. Attorney, San Diego, plans to accompany Special Agents to courtroom. Domestic Intelligence Division will obtain authority from Department of Justice and will coordinate with our Office of Legal Counsel.

RPF:ekw

GCM DLM/GCM
ESM/ALS

FEDERAL BUREAU OF INVESTIGATION
COMMUNICATIONS SECTION

AUG 22 1972

TELETYPE

File

Mr. Felt	_____
Mr. Bates	_____
Mr. Bishop	_____
Mr. Callahan	_____
Mr. Campbell	_____
Mr. Cleveland	_____
Mr. Conrad	_____
Mr. Dalbey	_____
Mr. Jenkins	_____
Mr. Marshall	_____
Mr. Miller, E.S.	_____
Mr. Ponder	_____
Mr. Soyars	_____
Mr. Walters	_____
Tele. Room	_____
Mr. Kinley	_____
Mr. Armstrong	_____
Ms. Herwig	_____
Mrs. Neenan	_____

NR 23 SD PLAIN
11:20 PM NITEL 8-21-72 LLC
TO ACTING DIRECTOR (157-23577) (ATTN: D I D)
FROM SAN DIEGO (157-2815) P

SECRET ARMY ORGANIZATION (SAO), EXTREMIST MATTERS.

*wcp:ag
HDF/12*

Boydson

Agent
SPECIAL AGENT JORDAN NAYLOR AND SPECIAL AGENT
EARL M. PETERSEN HAVE BEEN SUBPOENAED TO APPEAR IN SUPERIOR
COURT, SAN DIEGO COUNTY, SAN DIEGO, CALIFORNIA, AT TWO P.M.
ON AUGUST TWENTY FIVE, NEXT, BEFORE HONORABLE GILBERT
HARELSON, AS WITNESSES IN A CRIMINAL ACTION AGAINST
GEORGE M. HOOVER. SUBPOENAS ARE ISSUED AT THE REQUEST OF
LEIF TESSEM, ESQUIRE, DEFENDER S INCORPORATED, WHO HAS BEEN
APPOINTED TO REPRESENT DEFENDANT HOOVER.

*5-7-72 info
H. H. H.*

THIS MATTER HAS BEEN DISCUSSED WITH AUSA ROBERT
FILSINGER, AND FILSINGER HAS CONTACTED ATTORNEY TESSEM
REGARDING PURPOSE OF SUBPOENAS. TESSEM
HAS INDICATED HIS INTENTION TO DISQUALIFY THE CREDIBILITY
OF FORMER BUREAU INFORMANT, HOWARD BARRY GODFREY, ON GROUNDS

REC-65

157-23577-42

10 AUG 30 1972

END PAGE ONE

PAGE TWO

THAT GODFREY SWORE IN AN AFFIDAVIT THAT HE HAS BEEN IN CONTINUOUS CONTACT WITH SPECIAL AGENTS PETERSEN AND NAYLOR AND FORMER AGENT STEVEN L. CHRISTENSEN.

FILSINGER INDICATED ON AFTERNOON OF AUGUST TWENTY ONE, INSTANT, THAT RECONTACT WITH TESSEM DETERMINED THAT SA NAYLOR WILL PROBABLY NOT BE CALLED TO TESTIFY DUE TO THE EXTENDED PERIOD WHICH HAS ELAPSED SINCE SA NAYLOR WAS LAST CONTACTED BY GODFREY.

IN EVENT SPECIAL AGENTS PETERSEN AND NAYLOR ARE CALLED TO TESTIFY, THEY WILL BE ACCOMPANIED IN THE COURT ROOM BY AUSA FILSINGER AND ANY TESTIMONY WILL BE GIVEN IN ACCODANCE WITH CURRENT INSTRUCTIONS . UNDER CURRENT EXECUTIVE ORDERS AND FOLLOWING THE ADVICE OF AUSA FILSINGER, UACB.

PENDING.

~~MR. HORN~~
~~10/11/34~~

HEB 17

FBI

Date: 8/18/72

Mr. Felt	_____
Mr. Bates	_____
Mr. Bishop	_____
Mr. Callahan	_____
Mr. Campbell	_____
Mr. Cleveland	_____
Mr. Conrad	_____
Mr. Dalbey	_____
Mr. Jenkins	_____
Mr. Marshall	_____
Mr. Miller, E.S.	_____
Mr. Ponder	_____
Mr. Soyars	_____
Mr. Walters	_____
Tele. Room	_____
Mr. Kinley	_____
Mr. Armstrong	_____
Ms. Herwig	_____
Mrs. Neenan	_____

Transmit the following in _____
(Type in plaintext or code)

Via AIRTEL AIRMAIL - REGISTERED
(Priority)

TO: ACTING DIRECTOR, FBI (157-23577)

FROM: SAC, SAN DIEGO (157-2815) (P)

SECRET ARMY ORGANIZATION (SAO)
EXTREMIST MATTERS

Re San Diego letter to Bureau 8/15/72.

Enclosed for the Bureau is one copy of "Door" issue of 8/17 - 9/17/72.

The Secret Army Organization (SAO) is an anti-communist, paramilitary organization formed in 1971 in San Diego, California. It intends to conduct intelligence-type operations and to offer training in urban guerrilla warfare to be used against "Left-Wing Groups" and suspected enemies of the United States.

Enclosed copy of "Door", a local radical and New Left publication, carries a lead article on Page 1 captioned, "FBI Linked to SAO Terror", concerning the recent arrest of SAO members and alleging activities of the FBI in support of harassment against "left wing subversives".

Page 1 and 4 - 9 contained related articles alleging that the SAO was manipulated and guided by the FBI and police and informants of both of these agencies.

The enclosed newspaper is for the Bureau's information inasmuch as inquiry may be received from other news media regarding the articles in this publication.

- ENCLOSURE**
- 2 - Bureau (Enc. 1) (AM-RM)
 - 2 - San Diego

LFW:ejt
(4)

Approved: _____ Sent _____ M Per _____

UNITED STATES GOVERNMENT

Memorandum

TO : ACTING DIRECTOR, FBI

DATE: 8/16/72

FROM : SAC, LOS ANGELES (157-7318) (RUC)

SUBJECT: SECRET ARMY ORGANIZATION (SAO)
EM

JLB

Re Los Angeles letter to Bureau dated 5/18/72.

Enclosed for the Bureau are 8 copies of a letterhead memorandum concerning captioned organization.

One copy of this letterhead memorandum is being disseminated to the U. S. Secret Service, Los Angeles, due to the propensity for violence displayed by the Secret Army Organization, a group which reportedly advocates arming against a communist conspiracy.

Sources utilized in this letterhead memorandum are as follows:

Source One

Source Two

Source Three

INFORMANTS

According to sources that have been contacted, there is no Secret Army Organization in the Los Angeles area. Investigation has failed to show that SAM NAPIER has been connected with the Secret Army Organization and, through interview, he has denied any connection with or affiliation with the Secret Army Organization. NAPIER is still under-going investigation for his possible activities in the National Socialist American Workers Party (NSAWP).

In view of the absence of the Secret Army Organization in the Los Angeles area, this case is being RUC'd.

CLOSURE

REC-65

EX-117

157-23577-40

- 2 - Bureau (Enc. 8) (RM)
- 2 - San Diego (Enc. 2) (RM)
- 1 - Los Angeles

HLG/met
(5)

*1 cc ISB
1 cc CRD
1 cc SS*

*1 cc 8069-D
3 cc Destroyed*

4 AUG 23 1972



57 AUG 28 1972

*R/S
8/28/72*

wcp/mfm

*806
INT. SEC.*

Buy U.S. Savings Bonds Regularly on the Payroll Savings Plan



UNITED STATES DEPARTMENT OF JUSTICE

FEDERAL BUREAU OF INVESTIGATION

Los Angeles, California

August 16, 1972

In Reply, Please Refer to
File No.

SECRET ARMY ORGANIZATION
EXTREMIST MATTERS

Source One and Source Two, both of whom have furnished reliable information in the past, advised on August 3, 1972 that no such organization as the Secret Army Organization exists in the Los Angeles area, as far as they are able to determine. All of their information concerning such a group comes from newspaper articles, which reflect San Diego has such an organization. Sources added there is no past information concerning such a group. Both sources advised they could furnish no information that one Sam Napier might be connected with the Secret Army Organization.

Source Three, who has furnished reliable information in the past, has previously advised that Sam Napier had joined the Secret Army Organization and was reportedly one of the assistants in helping Jerry Lynn Davis organize the Secret Army Organization in the Los Angeles area.

CALIF.

On June 19, 1972, Sam Napier, Jr., was interviewed at his residence, 4806 West 137th Street, Hawthorne, California by Special Agents of the Federal Bureau of Investigation.

Napier advised that in the past he had belonged to a group called the American Nazi Party and that they had changed their name to the National Socialist White People's Party (NSWPP) and that he had resigned from this party in 1968. At his resignation, he directed a letter to the NSWPP local chapter, a copy to the National Headquarters of the NSWPP, and a copy to the Los Angeles Federal Bureau of Investigation.

157-235 17-40

SECRET ARMY ORGANIZATION

The National Socialist White People's Party, also known as the American Nazi Party, American Nazis, and the George Lincoln Rockwell Party, was organized on February 26, 1956 at Arlington, Virginia, based upon the concept of an international "National Socialist" movement as espoused by the German Nazi Party headed by Adolf Hitler. The organization supports and follows the line of hatred against Negroes, Jews, and communists through various pro-paganda media seeking a legitimate dominant political party in the United States and foreign countries.

Napier said he wanted out of the National Socialist White People's Party because of the Party breaking into splinter groups. He also objected to the leadership of the National Socialist White People's Party.

Napier was questioned about any information he might have concerning possible secret groups being formed in the Los Angeles area and he stated he had heard about a group called the Secret Army Organization that was in San Diego, but this group had not come to Los Angeles. Napier claimed the only contact he had with the Secret Army Organization was from a pamphlet he had received from this group, setting forth the aims and ideas of the organization. He said they are strictly anti-communistic and Pro-American in their approach. Napier denied that he had any affiliation whatsoever with the Secret Army Organization.

This document contains neither recommendations nor conclusions of the FBI. It is the property of the FBI and is loaned to your agency. It and its contents are not to be distributed outside your agency.

Memorandum

TO : ACTING DIRECTOR, FBI (157-23577) DATE: 8/15/72

FROM : SAC, SAN DIEGO (157-2815)

SUBJECT: SECRET ARMY ORGANIZATION
EXTREMIST MATTERS

On 8/14/72, Deputy JIM MURMACK, San Diego County Sheriff's Office, advised Agents of the FBI in San Diego that he had just surfaced from a six month undercover assignment, with his department. During this assignment he was closely associated with "The Door", a local radical and New Left publication.

MURMACK advised that an issue of "The Door" in the near future is to deal with the FBI's involvement with the SAO. He advised that "The Door" staff believes the FBI is working with the SAO against the New Left.

MURMACK said that in order to obtain background for the proposed article, "The Door" staff is conducting interviews at Godfrey's informant previous place of employment and is also going to attempt to interview STEVEN L. CHRISTENSEN, who they learned terminated his employment as a Special Agent of the FBI. MURMACK does not know where "The Door" staff obtained this information.

A separate letter has been forwarded to former SA CHRISTENSEN requesting that he advise the San Diego Office of the FBI if and when he is contacted by any individual regarding the above.

The above is being furnished for the Bureau's information and San Diego will follow any action taken by local dissident groups regarding above matter.

- 2 - Bureau (AM) (RM)
- 3 - San Diego (2 - 157-2815)
(1 - 170-286)

AJM:ejt
(5)

EX 101
REC-58

157-23577-39

AUG 18 1972

PERS. REC. UNIT

EXT. INT. SEC.



SEP 1 1972

U.S. Savings Bonds Regularly on the Payroll Savings Plan

COPY RETAINED IN PERSONNEL RECORDS UNIT

Domestic Intelligence Division

INFORMATIVE NOTE

Date 7/26/72

Summary

Previous data has been furnished regarding arrest of four white extremist Secret Army Organization (SAO) members being arrested by San Diego Police Department (SDPD) based on information furnished by San Diego Division extremist informant. Charges range from attempted murder to illegal possession of explosives.

Attached indicates additional arrests based on information from the San Diego Division extremist informant of two members of the SAO by the SDPD on charges of possession of explosives, receiving stolen property and possession of illegal tear gas gun. In addition a San Diego gun dealer was arrested by the Alcohol Tax and Firearms Division for selling illegal automatic weapon-conversion kits. Weapons, explosives and ammunition were confiscated during the arrest and searches of residences. Investigation continuing regarding possible stolen weapons recovered.

Copy of attached sent to Internal Security Division of the Department. Pertinent parts included in summary teletype to White House, Vice President, Attorney General, Secret Service and Defense Intelligence Agency.

WCP:aeh

*Gen
7-26
9:37*

EMD GCM/SUD UGC

FEDERAL BUREAU OF INVESTIGATION
COMMUNICATIONS SECTION

JUL 26 1972

TELETYPE

Mr. Bates	_____
Mr. Bishop	_____
Mr. Callahan	_____
Mr. Campbell	_____
Mr. Cleveland	_____
Mr. Conrad	_____
Mr. Dalbey	_____
Mr. Jenkins	_____
Mr. Marshall	_____
Mr. Miller, C.S.	_____
Mr. Pender	_____
Mr. Soyars	_____
Mr. Walters	_____
Tele. Room	_____
Mr. Kinley	_____
Mr. Armstrong	_____
Mr. Horvitz	_____
Mrs. Neenan	_____

NR 11 SD CODE

11:37 PM NITEL 7-25-72 GKF

TO ACTING DIRECTOR

FROM SAN DIEGO (157-2815) 7P

SECRET ARMY ORGANIZATION (SAO), EXTREMIST MATTERS.

January 6
ON JUNE TWENTY ONE, NINETEEN SEVENTY TWO, AN UN-IDENTIFIED ASSAILANT FIRED TWO SHOTS INTO THE RESIDENCE OF PETER BOHMER, A RADICAL PROFESSOR AT SAN DIEGO, ONE BULLET STRIKING PAULA THARP, AN ASSOCIATE OF BOHMER, IN THE RIGHT ELBOW. *CALIF.*

ON JUNE NINETEEN, NINETEEN SEVENTY TWO, AN UNIDENTIFIED SUBJECT PLANTED A BOMB IN THE GUILD MOVIE THEATRE, THREE EIGHT TWO SEVEN FIFTH AVENUE, SAN DIEGO, CALIFORNIA, CAUSING EXTENSIVE DAMAGE. *ST 111 157-2815-38*

ON JUNE TWENTY ONE, NINETEEN SEVENTY TWO, INFORMATION PROVIDED THE SAN DIEGO POLICE DEPARTMENT (SDPD) FROM SAO MEMBER HOWARD GODFREY, A LONG TIME INFORMANT FOR THE

END PAGE ONE MEMBER OF SUBJECT ORGANIZATION

AUG 3 1972

LET 002110E
FEDERAL BUREAU OF INVESTIGATION

8199
62 AUG 10 1972

PAGE TWO

SD 157-2815

FEDERAL BUREAU OF INVESTIGATION (FBI) REGARDING THE ABOVE TWO CASES AND OTHER PERSONS INVOLVED WITH THE SAO RESULTED IN SEARCH WARRANTS BEING SECURED AND EXECUTED FOR THE RESIDENCES OF WILLIAM FRANCIS YAKOPEC, GEORGE MITCHELL HOOVER AND RICHARD AND GENEVIEVE FLEURY. AS A RESULT, THESE FOUR INDIVIDUALS WERE ARRESTED AND CHARGED AS FOLLOWS:

Calif.

MEMBER OF SUBJECT ORGANIZATION

YAKOPEC WAS CHARGED WITH ATTEMPTED MURDER, BOMBING AND POSSESSION OF EXPLOSIVES. HOOVER WAS CHARGED WITH ATTEMPTED MURDER AND POSSESSION OF BILLY CLUB. RICHARD AND GENEVIEVE FLEURY WERE CHARGED WITH POSSESSION OF EXPLOSIVES.

THE SECRET ARMY ORGANIZATION (SAO) IS A PARA - MILITARY ORGANIZATION FORMED DURING THE EARLY PART OF OCTOBER, NINETEEN SEVENTY ONE, BY FORMER MEMBERS AND SUPPORTERS OF THE

END PAGE TWO

2

PAGE THREE

SD 157-2815

MINUTEMEN ORGANIZATION, FOR THE PURPOSE OF REPLACING THAT ORGANIZATION, NOW CONSIDERED DEFUNCT. WITH ITS HEADQUARTERS LOCATED AT SAN DIEGO, CALIFORNIA, THE SAO INTENDS TO WORK TOWARDS BECOMING A NATIONWIDE ORGANIZATION.

AS A RESULT OF INFORMATION FURNISHED BY GODFREY, THE FOLLOWING ACTION WAS TAKEN BY LAW ENFORCEMENT AGENCIES IN SAN DIEGO: MEMBER OF SUBJECT ORGANIZATION

ON JULY SEVEN, NINETEEN SEVENTY TWO, JERRY LYNN DAVIS, A CALIFORNIA SAO COORDINATOR WITH THE RANK OF CAPTAIN WITHIN THAT ORGANIZATION, WAS ARRESTED BY THE SAN DIEGO POLICE DEPARTMENT FOR POSSESSION OF EXPLOSIVES AND RECEIVING STOLEN PROPERTY.

ON JULY TWELVE, NINETEEN SEVENTY TWO, THE SAN DIEGO COUNTY GRAND JURY RETURNED TRUE BILLS ON YAKOPEC, HOOVER, AND RICHARD AND GENEVIEVE FLEURY.

END PAGE THREE

PAGE FOUR

SD 157-2815

ON JULY EIGHTEEN, NINETEEN SEVENTY TWO, THE GRAND JURY RETURNED A TRUE BILL ON JERRY LYNN DAVIS. SECOND INDICTMENT WAS RETURNED ON ROBERT MEYERS, SAO MEMBER FOR PERJURING HIMSELF DURING THE GRAND JURY HEARING OF JULY TWELVE, NINETEEN SEVENTY TWO. *CALIF.* MEMBER OF SUBJECT ORGANIZATION

ON JULY TWENTY ONE, NINETEEN SEVENTY TWO, A SEARCH WARRANT WAS SERVED ON VAHL BOYLES, RESIDENCE FOUR FOUR FOUR THREE UPLAND STREET, LA MESA, CALIFORNIA, BY THE SAN DIEGO POLICE DEPARTMENT, FOR WEAPONS, EXPLOSIVES, AND MILITARY DRUGS. MRS. BOYLES IS THE MOTHER OF TROY HAUGHTON, A LEADER OF THE SAN DIEGO MINUTEMEN ORGANIZATION, WHO MYSTERIOUSLY DISAPPEARED IN NINETEEN SIXTY SEVEN. *SAN DIEGO CALIF.*

A SUBSTANTIAL QUANTITY OF MILITARY DRUGS AND MEDICAL SUPPLIES WAS FOUND BURIED BENEATH THE BOYLES' RESIDENCE. EXPLOSIVE PARAPHERNALIA AND MINUTEMEN LITERATURE WAS ALSO DISCOVERED.

THE MINUTEMEN IS A PARAMILITARY GROUP ORGANIZED IN JUNE, NINETEEN SIXTY, BY ROBER B. DE PUGH IN NORBORNE,

END PAGE FOUR

4

SD 157-2815

PAGE FIVE

MISSOURI, AS A RESISTANCE TO THE
SPREAD OF COMMUNISM IN THE UNITED
STATES BY USE OF GUERRILLA TACTICS.
DE PUGH IS CURRENTLY INCARCERATED
IN A FEDERAL PENITENTIARY FOR VIOLATION
OF THE FEDERAL FIREARMS ACT.
THE PATRIOTIC PARTY HAS BEEN THE
POLITICAL ARM OF THE MINUTEMEN.

MEMBER OF SUBJECT ORGANIZATION

ON JULY TWENTYTHREE, NINETEEN SEVENTYTWO, A SEARCH
WARRANT WAS ISSUED ON THE RESIDENCE OF HOWARD FRANCIS
CLARK, ONE ZERO EIGHT ZERO SIXTH STREET, RAMONA, CALIFORNIA,
FOR EXPLOSIVES, AND ILLEGAL WEAPONS. CLARK WAS ARRESTED
BY THE SAN DIEGO POLICE DEPARTMENT FOR POSSESSION OF
EXPLOSIVES (TWO COUNTS), POSSESSION OF AN ILLEGAL TEAR
GAS GUN, AND RECEIVING STOLEN PROPERTY. THOUSANDS OF
ROUNDS OF MILITARY AMMUNITION WERE SEIZED ALONG WITH
DEACTIVATED LAND MINES, ASSORTED MORTAR ROUNDS, NUMEROUS
END PAGE FIVE

SD 157-2815

PAGE SIX

RIFLES AND HAND GUNS, AND SAO LITERTURE^K. CLARK ADMITS
BELONGING TO THE SAO.

ON JULY TWENTYFOUR, NINETEEN SEVENTYTWO, THOMAS^S
FORREST, A SAN DIEGO GUN DEALER, WAS ARRESTED FOR THE
SALE OF SEVERAL ILLEGAL^{CALIF.} AUTOMATIC WEAPON CONVERSION KITS,
TO UNDERCOVER SAN DIEGO POLICE DEPARTMENT OFFICER. HE
WAS ARRESTED BY THE ALCOHOL, TOBACCO AND FIREARMS DEPARTMENT
(ATFD).

ON JULY TWENTYFOUR, NINETEEN SEVENTYTWO, SAN DIEGO
COUNTY SHERIFF'S INVESTIGATORS SEIZED A CACHE OF
WEAPONS AND EXPLOSIVES IN THE CUYAMACA PARK AREA.
INCLUDED WAS A FLAME THROWER, LAND MINE FUSES, A QUANTITY
OF EXPLOSIVES, AND PRIMER FUSES OF THE TYPE USED IN THE
BOMBING OF THE GUILD MOVIE THEATRE IN SAN DIEGO.

ON JULY TWENTYFIVE, NINETEEN SEVENTYTWO, NEWS^L
MEDIA IN SAN DIEGO, INCLUDING KFMB, CHANNEL EIGHT
TELEVISION, AND KGTV, CHANNEL TEN TELEVISION CARRIED
A NEWS STORY REGARDING THE QUOTE PROBE OF SECRET
ARMY AND QUOTE, REVEALING THAT GODFREY, AN FBI INFORMANT,
END PAGE SIX

6

PAGE SEVEN

SD 157-2815

HAD TESTIFIED BEFORE THE GRAND JURY AND THAT A TWENTY
FOUR HOUR PROTECTIVE SURVEILLANCE HAD BEEN PLACED
AROUND HIS HOME BY THE SAN DIEGO POLICE DEPARTMENT.

ON JULY TWENTY FIVE, NINETEEN SEVENTYTWO, DETECTIVE
REUBEN BRANDON, SAN DIEGO POLICE DEPARTMENT, ADVISED
THAT HE DOES NOT BELIEVE FURTHER ARRESTS WILL RESULT
FROM THE CURRENT INVESTIGATION OF THE SAO.

ADMINISTRATIVE:

SAN DIEGO HAS CLOSELY FOLLOWED ACTIVITIES INVOLVED
IN THE SAO PROBE BY THE SAN DIEGO POLICE DEPARTMENT AND
OTHER LAW ENFORCEMENT AGENCIES FOR POSSIBLE PROSECUTIONS
FOR VIOLATIONS OF FEDERAL LAW BY THE FBI. ANY WEAPONS
RECOVERED WHICH ARE POSSIBLY STOLEN MILITARY WEAPONS
ARE BEING MADE THE SUBJECT OF CURRENT INVESTIGATION
BY THE SAN DIEGO OFFICE.

END

BJM FBI WASHDC

ACK FOR NR019 & 011

CLR

cc MR. TRAINOR
ROOM 712-A 92D

7

San Diego, California
August 10, 1972

San Diego File: 157-2815
Bufile: 157-23577

APPENDIX

SECRET ARMY ORGANIZATION (SAO)

The Secret Army Organization (SAO) is an anti-communist, paramilitary organization formed during the early part of October, 1971 in San Diego, California, by former members and supporters of the Minutemen Organization and for the purpose of replacing that organization, which was considered defunct in the San Diego area.

On January 7, 1972, according to a source, the SAO intended to conduct intelligence-type operations and offer training in urban guerrilla warfare to be used against "Left-Wing Groups" and suspected enemies of the United States.

The SAO is headquartered in San Diego, California, and intends to become a nationwide organization.

APPENDIX

Source: INFORMANT

*not of
preclude
in informant
DPA*

157-23577-

NOT RECORDED

3 AUG 17 1972

APPROVED

Date 67 AUG 29 1972

INT. SEC.

Ext. [Signature]

San Diego, California
August 10, 1972

San Diego File: 157-2815
Bufile: 157-23577

BRIEF DESCRIPTIVE CHARACTERIZATION

SECRET ARMY ORGANIZATION (SAO)

The Secret Army Organization (SAO) is an anti-communist, paramilitary organization formed in 1971 in San Diego, California. It intends to conduct intelligence-type operations and to offer training in urban guerrilla warfare to be used against "Left-Wing Groups" and suspected enemies of the United States.

BRIEF DESCRIPTIVE CHARACTERIZATION

Source: INFORMANT

*not to be used
without
approval*

157-23577-

NOT RECORDED

3 AUG 17 1972

APPROVED
Date

8/30/72

61 AUG 29 1972

6540

*INT. SEC.
Ext. Sec*

SAC, San Diego (157-2815)

8/7/72

Acting Director, FBI (157-23577)

1 - Mr. W. C. Patterson

**SECRET ARMY ORGANIZATION (SAO)
EXTREMIST MATTERS**

ReSDtel 7/25/72 that furnished a summary regarding the arrest of SAO members in the San Diego area by the San Diego Police Department and Alcohol, Tobacco and Firearms Division.

In connection with these arrests, it was noted that rifles, handguns and various other weapons and explosives were confiscated. It was mentioned that searches incidental to the arrests located SAO and Minutemen literature. San Diego obtain from San Diego Police Department copies of this literature, lists of weapons confiscated, and copies of any photographs taken of weapons confiscated. Submit this material as attachments to an LHM which should explain the circumstances and location where found. Such information will be of pertinence to our investigation of the SAO and will be of assistance in the Bureau's training program.

Follow local prosecutive action regarding the SAO members and insure the Bureau is kept fully apprised of developments. Remain alert for possible violations coming within the jurisdiction of this Bureau and insure appropriate action is taken.

WCP:aso (4) 650
NOTE:

REC 44
EX-114 157-23577-37

SAO is an anticommunist, ultraconservative, paramilitary organization which was formed in San Diego in 1971. Referenced teletype furnished a summary of information regarding arrest of six SAO members by the San Diego Police Department and the Alcohol, Tobacco and Firearms Division. The charges against those arrested ranged from attempted murder to possession of explosives. San Diego has not furnished copies of literature confiscated during arrests or submitted a listing of weapons confiscated. This literature and photographs of weapons confiscated should be of interest in our training program.

6 AUG 7 1972

- Felt _____
- Bates _____
- Bishop _____
- Callahan _____
- Campbell _____
- Cleveland _____
- Conrad _____
- Dalbey _____
- Jenkins _____
- Marshall _____
- Miller, E.S. _____
- Ponder _____
- Soyars _____
- Walters _____
- Tele. Room _____
- Mr. Kinley _____
- Mr. Armstrong _____
- Ms. Herwig _____
- Neenan _____

MAILED 21
AUG 4 - 1972
FBI

SSC Request 1/20/76
Item 2 (Re: Howard Berry Godfrey)
Volume IV

Retain

Date prepared

2/24/71

Date received

2/9/71

Received from (name or symbol number)

Informant
SD 1155-R

Received by

SA Steven L. Christensen

Method of delivery (check appropriate blocks)

in person by telephone by mail orally recording device written by Informant

If orally furnished and reduced to writing by Agent:
Date

Date of Report

Dictated 2/19/71 to G. Ramsey

2/9/71

Transcribed 2/23/71

Date(s) of activity

Authenticated by Informant 2/24/71

2/8/71

Brief description of activity or material

Contact w/ Isaac Cantrell

File where original is located if not attached

* INDIVIDUALS DESIGNATED BY AN ASTERISK (*) ONLY ATTENDED A MEETING AND DID NOT ACTIVELY PARTICIPATE. VIOLENCE OR REVOLUTIONARY ACTIVITIES WERE NOT DISCUSSED.

Information recorded on a card index by _____ on date _____

Remarks:

157-1998 (MM)

170-286A-76

157-2224 (Cantrell)

~~157-91-3149~~ (De Pugh)

~~157-91-3149~~ (Walker Patrick Peyson) (or index)

91-3149*
91-3149*

170-286A-76
Block Stamp

SEARCHED <input checked="" type="checkbox"/>	INDEXED <input checked="" type="checkbox"/>
SERIALIZED <input checked="" type="checkbox"/>	FILED <input checked="" type="checkbox"/>
FEB 26 1971	
FBI - SAN DIEGO	

On February 9, 1971
By JEROME

I contacted the mystery man last night at Denny's Restaurant and it turned out to be ISAAC CANTRELL. He told me that he previously lived in Arizona and because of some trouble or difficulty there, moved to Los Angeles, California.

He said he believed he had been followed to Los Angeles. He subsequently moved to the San Diego area and is now living in Alpine.

We talked about his recent arrest on charges of violating firearms laws and he said the charges against him have been dismissed. He said he thinks the local authorities are still watching him, and that they may try to arrest him again if they get the chance.

He said he still has most of his stuff for working on firearms but indicated that the articles which were confiscated at the time of his arrest had not been returned to him.

As an additional note of interest, he told me he had been in contact with BOB DE PUGH and WALTER PEYSON at Phoenix, Arizona, approximately three months before they were arrested.

I plan to proceed slowly in my contacts with CANTRELL as he may be a set-up for the local or state authorities.

Jerome

Date prepared

2/24/71

Date received

2/11/71

Received from (name or symbol number)

Received by

[Signature]

Method of delivery (check appropriate blocks)

in person by telephone by mail orally recording device written by Informant

If orally furnished and reduced to writing by Agent:

Date

Dictated

2/19/71 to G. Kammery

Transcribed

2/23/71

Authenticated by Informant

2/24/71

Date of Report

2/11/71

Date(s) of activity

2/10/71

Brief description of activity or material

Info re Domenico, Davis, Cantrell, NCEAP

File where original is located if not attached

100-15462

* INDIVIDUALS DESIGNATED BY AN ASTERISK (*) ONLY ATTENDED A MEETING AND DID NOT ACTIVELY PARTICIPATE. VIOLENCE OR REVOLUTIONARY ACTIVITIES WERE NOT DISCUSSED.

Information recorded on a card index by _____ on date _____.

Remarks:

157-2178 (Domenick)
170-286A-77
100-14297 (Davis)
100-15356 (Hoover)
100-15462 (NCEAP)
100-14427 (MIC)

Block Stamp

170-286A-77

SEARCHED	INDEXED
SERIALIZED	FILED
FEB 26 1971	
FBI - SAN DIEGO	

[Signature]

EXPERIENCING

On February 11, 1971
By JEROME

The photograph of RONALD TIMOTHY DOMENICK is not familiar to me. However, I will scout around and see if I can find out something about him.

I was talking to SAM DAVIS yesterday. He told me he recently came close to killing a police officer and explained that he and GEORGE HOOVER were hauling a trunk full of machine guns in one of their cars when they were stopped because they had a bad headlight.

DAVIS said he got out to mee the officer and had a .45 caliber pistol under his belt on his back and a hand grenade in each pocket of his jacket. He said HOOVER, who stayed in the car, was covering him with a Thompson sub-machine gun. He said if the officer had tried to look in the car they probably would have had to kill him.

CANTRELL and I have set up a method whereby there will be a five minute period of time each week during which I can contact him at a specified telephone number.

Attached are some printed materials from the National Center for the Exploration of Human Potential. These items were obtained a while ago by the Minutement from the files of the Message Information Center.

Jerome

Registration Form

Fee is tax deductible

- \$31 Per Person
- \$55 Per Couple
- \$20 For Full Time Students

Meals included.

Name _____

Address _____

City _____

State _____ Zip _____

20% reduction in program cost for Center Members

National Center for the Exploration of Human Potential
1080 El Paseo Grande, La Jolla, California 92037

NON-PROFIT ORGANIZATION
U.S. POSTAGE
PAID
SAN DIEGO, CALIFORNIA
PERMIT NUMBER 747

EXPERIENCING

THE FREEDOM, INTIMACY AND

ZEST OF A

MODEL COMMUNITY

November 20, 21, 22

TORREY PINES INN

La Jolla, California

National Center for the Exploration of
Human Potential

EXPERIENCING COMMUNITY THE TORI EXPERIENCE

The TORI community starts with several experiences designed to build a sense of community, and to deepen personal growth.

Stemming from these experiences, the community unfolds and emerges. Each member has an opportunity to participate in this process and to influence the unfolding in significant ways. The community becomes a powerful medium for personal change. Members have an opportunity to relate intensely and openly to many others in a variety of situations. They are free to try out new ways of being and doing. Each participant is responsible for his own learning, and has a variety of options and choices during the weekend. Each person, in a significant sense, creates his own experience and his own community environment.

The TORI experiences (trust, openness, realization, and interdependence) emerge from the community interaction. They are seen as central to the growth of the person as well as to the development of community. The basic TORI theory will be presented by Dr. Jack R. Gibb as it is applied to the building of a sense of community in classrooms, neighborhoods, congregations, families, and the total school or business system.

Sandra La Boon, who will be conducting the workshop, has worked with Dr. Gibb over the past two years in a wide variety of group

experiences. She has conducted groups with the Center, Y.M.C.A.'s of Los Angeles and San Diego and with the Methodist Church. She is currently conducting research with Dr. Gibb on the TORI theory.

DESIGN

The community is built upon 24 hours of experiences over a three-day period. Participants should plan to attend for all 24 hours. No observers will be admitted although participants will have freedom to participate in an experience or not. We start after dinner, 7:30 PM on Friday. The Experience ends 5:00 PM on Sunday. It is not necessary to stay over night at the Inn.

CLOTHING

The dress should be comfortable and informal, so you can sit on the floor and go barefooted or wear socks.

SCHEDULE

Friday night from 7:30 p.m. - 11:00 p.m.

Saturday from 9:00 a.m. - 11:00 p.m.

Sunday from 9:00 a.m. - 5:00 p.m.

MEALS

Meals are an integral part of the experience and participants should plan to have all meals with the group. There is no additional charge for meals.

AN UNUSUAL OPPORTUNITY FOR GROUP LEADERS

For the first time we will be providing a program to train leaders in conducting the TORI Community Experience.

In order to be eligible to take the leader training it will have been necessary for each potential leader to have experienced a complete TORI weekend.

The training will be in the evening November 22, 23, and 24th, 7:30 to 10:00 P.M. at the National Center 8080 El Paseo Grande, La Jolla, California.

Cost of the training is \$25.00.

Center news



OCTOBER, 1970

Mari Murdock, Editor
Bonnie Weber, Artist

TORI WEEKEND WITH SANDRA LA BOON
by Ann Sturgis

November 20, 21, and 22
Friday evening, Sat. & Sun.

This is an adventure in a community of high trust living. The experiences of the weekend are based on the theory formulated by Dr. Jack R. Gibb, his wife Lorraine, and associates. The program has been given for national conferences, staff and management of companies, college faculties, congregations, freshman orientation programs, high school student bodies, and other groups. Sandra La Boon has been working with Dr. Gibb for the past two years and does research upon the effects of the TORI experience upon participants and their organizations. She is warm, charming, and competent as a leader.

WHAT CAN HAPPEN IN A TORI WEEKEND? Trust can emerge, chasing away a lot of vague anxieties and insecurities. You can get in touch with your freedom and self-determination. Experience an openness and sense your flow in life. You can explore your own feelings about touching and being touched. Become more aware of your own initiative. Shed the bondage of a role, become spontaneous. You may experience, as some participants have, transcendental or mystical experiences. Take part in a celebration. Recapture the pleasure of being alive and human.

For reservations or further information, contact the Center.

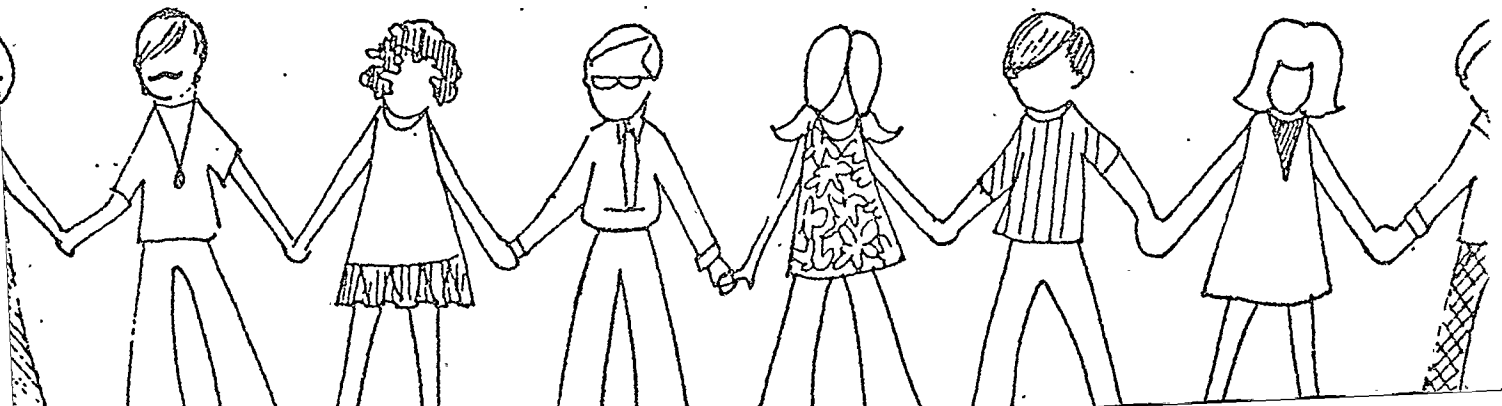

MODEL PROJECTS REPORT

Parent and Early Childhood--Three meetings have already been held with future meetings scheduled weekly. The last meeting was ecstatic and productive, breaking up after midnight. Contact Jan Hickman (454-5915) for information.

Senior Citizens--One meeting has already been held. Winnie Yee (273-4838) is coordinating temporarily, but we need a permanent coordinator.

Teen Program--Dee Thieda is coordinating. The first meeting was held October For further information, contact the Center.

Parent-Teen Committee--No meetings have yet been held. A coordinator is need If interested, please call Al Lewis at the Center.

Business and Industry--Dave Perlis and Jay Singh are coordinating. One meeti has been held and Dave and Jay are eager to involve more people. Contact the Center, or try Jay at home, 488-4128.

Churches--A committee is being formed to work with the churches. Several ministers have indicated interest. Please contact Al Lewis for further infor mation.

Women's Program--Mari Murdock--I am interested in contacting anyone who is interested in working on the development of a pilot program aimed at helping women move away from the sex-role stereoetype and into a greater realization o our own identity, strength and creativity as human beings. I have contacts with the Women's Studies Program at San Diego State College and a rather com- prehensive bibliography of the literature in this field which may be of some I'd like to begin meeting with a group of female members and friends of the Center as a first step in the effort to identify what points we'd like to cover with the pilot program. While the initial rap sessions may be limited to women only, men are welcome at the committee meetings. If interested, please give me a call at home (583-1563) or leave your name with someone at the Center.



If you are interested in any of these committees, please contact Al Lewis or the respective coordinators.

Dear Fellow Member:

As your new membership director I would like to tell you how excited am about the exciting things that are happening at the National Center. But, before I go into that, let me tell you how I became associated with it. A DPP on September 26 and 27, led by Al Lewis and Winnie Yee, convinced me of what I had increasingly come to believe over the last two years--the ultimate beauty in the world is the human being--you and me--each of raw material for the most beautiful works that can possibly be created.

I came to the Harvard Business School from New Delhi, India, in May, with the intention of acquiring the skills to go and capture for myself treasures of the outside world. Oh! I was determined to be relentless in my seeking and if someone got hurt, or had to be hurt, it was going to be all in the line of business.

Now, having gotten my MBA and having started work on my Ph.D. in Leadership and Human Behavior at USIU, I'm realizing that there is something more important for me to do, and this is to strive to tap more of my own inner, infinite potentialities, to strive for growth as a person, to make myself a beautiful work of art. The real treasure lies within me, not outside of me. Well, I'm embarked on this journey--on this adventure it is becoming more of a person.

But I have realized too, that I can do this only with the help of other people. I can only actualize my infinite potentialities by helping other people actualize theirs. And so, I accepted the responsibility that Al Lewis requested me to take up--and I have launched the 1970 Fall Membership Drive. My goal is to double our present membership, i.e., to increase the number of Participating Members by at least 240 by December, 1970. That's the very least the Center must do. That's the smallest increase my conscience will allow me. Our long range goal is to reach out to the millions in San Diego, in the U.S.A., and elsewhere around the world.

And in this, I need your help. Will you join with me in this program to reach out to more people? I would like to suggest this to each member. Reach out to one person in each of the last three months of 1970 and ask him to become a Participating Member of the National Center. Also, please renew your own membership if it's about to expire. Al and I have developed a list of privileges for members (see articles on membership and Esalen tapes), but these are all insignificant relative to the inner joy of helping people to become everything they are meant to be.

Two other important programs, the Community Action Program and the Model Projects Program, have been launched. The National Center is going forward. This is due to you and other members like yourself. Now I'm asking more of you--to help us reach our objective of at least another 240 members by December, 1970.

Thanks, and Love to all of you.

Jay Singh
Membership Director

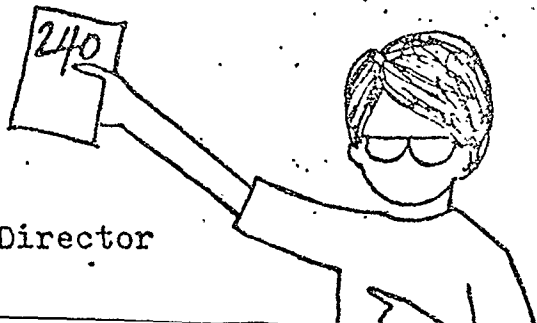

MEMBERSHIP INFORMATION

The National Center offers the following membership opportunities:

TYPE OF MEMBERSHIP	COST	ADVANTAGES
DONOR	\$1000 or more per year	<ol style="list-style-type: none"> 1. All advantages of Participating Member 2. 12 scholarships (to any \$33.00 program)
SPONSORING	\$500 or more per year	<ol style="list-style-type: none"> 1. All advantages of Participating Member 2. 6 scholarships
SUSTAINING	\$100 or more per year	<ol style="list-style-type: none"> 1. All advantages of Participating Member 2. 2 scholarships
PARTICIPATING	<ol style="list-style-type: none"> (a) FAMILY \$40.00/year (b) REGULAR \$25.00/year (c) FULL-TIME STUDENT \$15.00/year 	<ol style="list-style-type: none"> 1. All advantages of mailing list membership 2. Borrowing privileges from Center cassette tape library Human Potentialities book library 3. All Center programs available to you at 20% discount 4. Opportunity to participate in Center Model Projects Program 5. Opportunity to actualize your own potential and help other actualize theirs through other activities determined by you and the Center.
MAILING LIST	\$3.00 per year	<ol style="list-style-type: none"> 1. 2 page BULLETIN of behavioral science research findings to aid your personal growth 2. Newsletter 3. Schedule of programs 4. Information on all growth centers and human potentialities programs upon request

But, above all, the opportunity to work with us, to join us in reaching out to more people in San Diego, the United States, and beyond, is the MOST IMPORTANT ADVANTAGE.

TAPES FROM ESALEN

The following tapes have been ordered from Esalen. They should be available for use of members only by the middle of November, 1970. The tapes will be available on a library-loan basis, the details of which are being finalized

SURVEY AND BACKGROUND OF HUMAN POTENTIAL MOVEMENT

ABRAHAM MASLOW: Farther Reaches of Human Nature	2 hrs.
CARL ROGERS: Intensive Group Experience	1 hr.
RICHARD MARSH: Beyond Games	1 hr.
WILSON VAN DUSEN: Interview by Michael Murphy	2 hrs.
GEORGE LEONARD: Steps Toward Utopia	1 hr.
MICHAEL MURPHY: From Dream to Reality	1 hr.
WILLIAM SCHUTA: Theory for Esalen & Microlab Experience	2 hrs.
FREDERICK S. PERLS: Dream Theory & Demonstration	1 hr.
FREDERICK H. STOLLER: Interview by Connie Goldman	1 hr.
EDWARD MAUPIN: Guided Meditation in Body Awareness	2 hrs.
ALAN WATTS: Divine Madness	2 hrs.
JOSEPH CAMPBELL: Freud, Jung, & Kundalini Yoga	1 hr.
SIDNEY JOURARD: Human Uses of Behavioral Research	1 hr.
ROBERT GERARD: Psychosynthesis	2 hrs.
VIRGINIA SATIR: Family Communication & Growth	1 hr.
DONALD JACKSON: New Methods of Working with the Family	1 hr.
JACK & LORRANINE GIBB: The Emergent Group	2 hrs.
17 titles	24 hours

BROAD SCOPE OF THE FUTURE & CAPACITY FOR HUMAN GROWTH

USA 2000: THREE ALTERNATIVE VIEWS: Rogers, Watts, Kahn	2 hrs.
GEORGE LEONARD: Predictions for Education	1 hr.
MICHAEL MURPHY: A Survey of Current Programs	1 hr.
GEORGE STEINER: Critical Comment	2 hrs.
SUZUKI ROSHI: Teachings & Disciplines of Zen	2 hrs.
ALAN WATTS: The Diamond Way	1 hr.
JOSEPH CAMPBELL & HUSTON SMITH: Tibet	1 hr.
R. D. LAING: Introductory Tape on Sanity	2 hrs.
JOHN PERRY: Journey into Archetypal Myth	1 hr.
STANISLAV GROF: LSD Therapy	1 hr.
POETRY OF MADNESS: Perry, Watts, Naranjo, Ginsberg	2 hrs.
HARVEY COX: Religion in the 21st Century	2 hrs.
ABRAHAM MASLOW: Psychology of Religious Awareness	1 hr.
WILLIAM SCHUTZ: A Guided Fantasy Demonstration	1 hr.
DANE RUDHYAR & CLAUDIO NARANJO: Symbols of Unfoldment	2 hrs.
JOHN C. LILLY: Learning from the Dolphins	2 hrs.
16 titles	24 hours

NEEDS AND WANTS

Do you have any of the following lying around collecting dust, or do you know of anyone who might be persuaded to part with their treasure in the service of a good cause? We still need

filing cabinets (one legal size and one regular)
vertical and horizontal files
a small desk
sturdy table for typewriter
books for Human Potentialities Library
New Members

Anyone willing to donate 25 square yards of carpeting for the group room at the Center?

Face lifting at the Center offices is proceeding rapidly. Have you seen the new table and shelves built for us by Al Attig of San Diego Product Engineering? We've decided on a color scheme and are looking for people willing to make drapes and help with painting. If you have skills and/or enthusiasm, please contact Brax Millard (277-6442). Brax is our "artist", also a gardener and landscape designer by profession who is looking for additional free lance work. The Center's new bulletin board and the DPP posters are samples of his creativity and competence.

We still need a large house or equivalent, preferably in the San Diego area, which can be made available for Center residential programs. Suggestions, offers or questions should be directed to Audrey or Al at the Center.

REPORT ON FUNDING PROPOSAL -- Len Chase

An NCEHP preliminary resume was prepared. It contains a description of the Center's programs and plans, organization and cost projection for a three year period. Copies are being made available to certain agencies and foundations. By this means, funding for the support of current and on-going programs is being solicited. Efforts are now being turned toward the expansion of resume data and the start of special purpose funding proposals.

MESSAGE TO DPP LEADERS

Leaders who have been trained by Dr. Otto still need to lead several practicum before their training is considered complete. Any leader who wants additional practicum experiences, please contact Winnie Yee at home (273-4838) or at the Center.

REPORT ON PRACTICUM WEEKENDS -- Winnie Yee

Since July, a total of 50 leaders trained from the Summer Institute and previous training sessions have led practicum (training) weekends. Approximately 200 individuals from the San Diego community have participated in these weekends. They come from all walks of life with ages ranging from 15 to 60. Feedback indicates that these practicums have been growth experiences for both leaders and participants. It is anticipated that leaders undergoing training will have an opportunity to lead every 4-6 weeks with a greater number of the participants coming from the various colleges in the area.

Date prepared

2/24/71

Date received

2/12/71

Received from (name or symbol number)

~~Informant~~
SD/155-R

Received by

SA Steven L. Christense

Method of delivery (check appropriate blocks)

in person by telephone by mail orally recording device written by Informant

If orally furnished and reduced to writing by Agent:

Date

Dictated

2/23/71 to V. Wilson

Transcribed

2/23/71

Authenticated by Informant

2/24/71

Date of Report

2/12/71

Date(s) of activity

Week ending
2/12/71

Brief description of activity or material

Info re William Cantrell

File where original is located if not attached

* INDIVIDUALS DESIGNATED BY AN ASTERISK (*) ONLY ATTENDED A MEETING AND DID NOT ACTIVELY PARTICIPATE. VIOLENCE OR REVOLUTIONARY ACTIVITIES WERE NOT DISCUSSED.

Information recorded on a card index by _____ on date _____

Remarks

138-2224 (Isaac Cantrell)

170-286A-78

170-286A-78
Block Stamp

SEARCHED	INDEXED
SERIALIZED	FILED
FEB 26 1971	
FBI - SAN DIEGO	

February ¹² ~~11~~, 1971
BY JEROME

I have made arrangements whereby I can contact ISAAC CANTRELL at a pay telephone during a five minute period of time once a week. The next scheduled contact period is for the middle of next week. He wants to be contacted at that time as he wants to have some phony identification made up for him. He feels he needs this extra identification in order to hide out or conceal himself in the event it looks as though the authorities are going to try to bust him again.

He apparently is still capable of producing his homemade machine guns, and there is some indication he may be willing to trade a completed model of this machine gun for the phoney identification.

Jerome

Date prepared

2/24/71

Date received

2/18/71

Received from (Name or symbol number)

~~Informant~~
SD 1153-R

Received by

SA Steven L. Christensen

Method of delivery (check appropriate blocks)

in person by telephone by mail orally recording device written by Informant

If orally furnished and reduced to writing by Agent:

Date

Dictated

2/19/71 to G. Kasey

Transcribed

2/23/71

Authenticated by Informant

2/24/71

Date of Report

2/18/71

Date(s) of activity

2/17/71

Brief description of activity or material

SAC rally

File where original is located if not attached

100-13847

* INDIVIDUALS DESIGNATED BY AN ASTERISK (*) ONLY ATTENDED A MEETING AND DID NOT ACTIVELY PARTICIPATE. VIOLENCE OR REVOLUTIONARY ACTIVITIES WERE NOT DISCUSSED.

Information recorded on a card index by _____ on date _____

Remarks:

- 157-1798 (MAM)
- 170-286A-79
- 100-13847 (SAC)
- 100-14495 (Alan Stancliff)
- 100-14646 (Connie Stancliff)
- 100-14485 (Williams)
- 100-15507 (Nystrom)
- 100- (Dr. George Abbot #)
- 100-14297 (Davis)
- 100-14892 (MDM)
- 100-11836 (YSA)

Index: Peoples Peace Treaty (100-13847)

Open Deal

Block Stamp

SEARCHED INDEXED
 SERIALIZED FILED
 FEB 26 1971
 FBI - SAN DIEGO
 (Signature)

170-286A-79

On February 18, 1971
By JEROME

I was present at the SMC sponsored rally yesterday. It looked as though 250 persons were present. Most of the well known radical names were present such as ALAN STANCLIFF, CONNIE STANCLIFF, BILL WILLIAMS, B. J. MYSTROM, DR. GEORGE ABBOTT and others.

Nothing spectacular happened, and I was unable to listed to the speakers as I was forced to leave early. This was because B. J. BYSTROM, who knows me very well, was circulating around and I did not want to be recognized.

I was talking to SAM DAVIS last night and he told me an interesting thing. He said that some of the Minutement have discovered that their fingerprints can be temporarily disfigured or obliterated simply by spraying them with this new clear spray bandage or by rubbing white glue like Elmer's Glue on them.

Attached are the leaflets I obtained yesterday at the rally.

Jerome

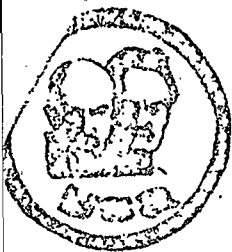

CLASSES IN REVOLUTIONARY SOCIALISM

IF YOU ARE CONCERNED ABOUT THE STRUGGLES GOING ON IN THE WORLD TODAY AND IN WAYS TO HELP THESE STRUGGLES CULMINATE IN A BETTER SOCIETY—COME TO THE INFORMAL CLASSES SPONSORED BY THE YOUNG SOCIALIST ALLIANCE. WE OFFER A MARXIST ANALYSIS OF WHAT'S HAPPENING TODAY AND A CONCRETE PROGRAM FOR CHANGING SOCIETY.

- Feb. 10 REVOLUTION IN THE UNITED STATES?
Reading: How to Make a Revolution in the U.S. by Peter Camejo
- Feb. 17 THE STATE AND REVOLUTION
Reading: The Marxist Theory of the State by Ernest Mandel.
- Feb. 24 THE STRUGGLE FOR BLACK LIBERATION
Reading: Transitional Program for Black Liberation
How a Minority Can Change Society by George Breitman
- Mar. 3 WHAT IS CAPITALISM?
Reading: The Teachings of Karl Marx by V.I. Lenin
- Mar. 10 THE REVOLUTIONARY POTENTIAL OF FEMINISM
Reading: Problems of Women's Liberation by Evelyn Reed
- Mar. 17 THE CHICANO LIBERATION STRUGGLE
Reading: La Raza! Why Chicano Party? Why Chicano Studies?
- Mar. 24 HOW TO DEFEND THE VIETNAMESE REVOLUTION
Reading: War and Revolution in Vietnam by Doug Jenness
Liberalism, Ultraleftism and Mass Action by Camejo
- Mar. 31 SOCIALISM AND THE POTENTIAL OF HUMAN BEINGS
Reading: Socialism and Man by Che Guevara

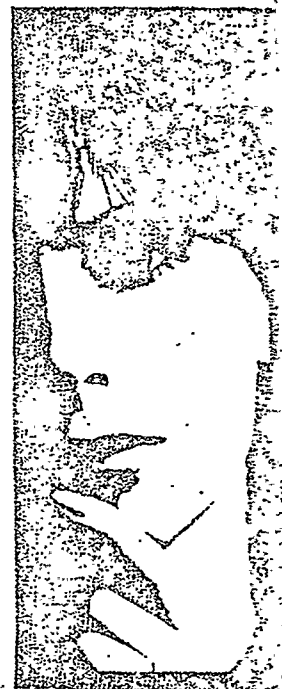

WEDNESDAYS at 7:30 p.m.
San Diego State College
Aztec Center, Room N
given by the



OZZIE NEVER HAS A NICE DAY...

Some judge in Oregon gave Ozzie Osborn a choice:

"DO YOUR TIME IN THE JOINT
OR DO 4 YEARS IN THE MILITARY"

Ozzie thought he might be getting a good deal...
A chance to make himself into something [a man]

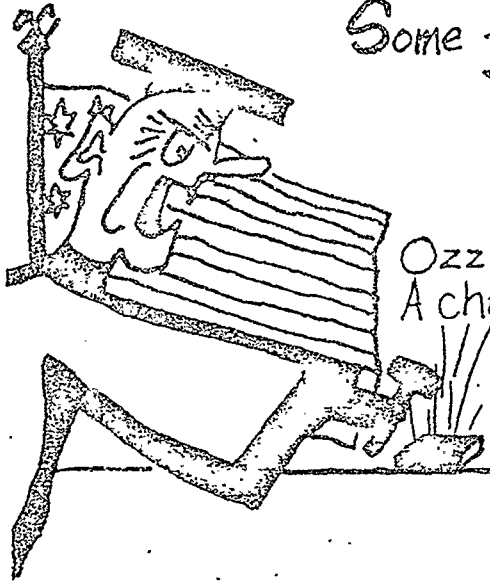

When Ozzie joined the Marine Corps, he looked around.
He saw that instead of becoming a man,
he was becoming a robot...
trained to kill poor people...
trained to be cannon fodder...

Ozzie hated the corps.
He and 15 other GI's
skipped out on their company
in a slave revolt. Ozzie was
a delinquent just like
back home.

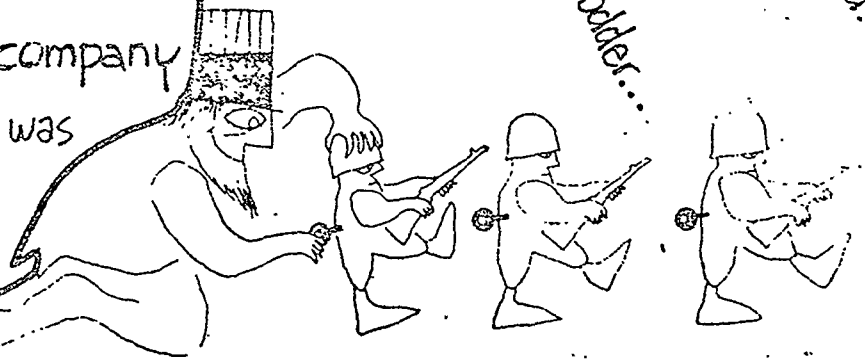

But this time he didn't feel like he was
all wrong and they were all right.
He felt strong and joined up with other GI's
who felt the way he did about the service.

Being inside the Corps is hard enough. Fighting it from the inside takes a super-together-head.

So Ozzie took a vacation in Kanada to get ready before

he came back again to join other GI's in resisting the military and the War in Asia.

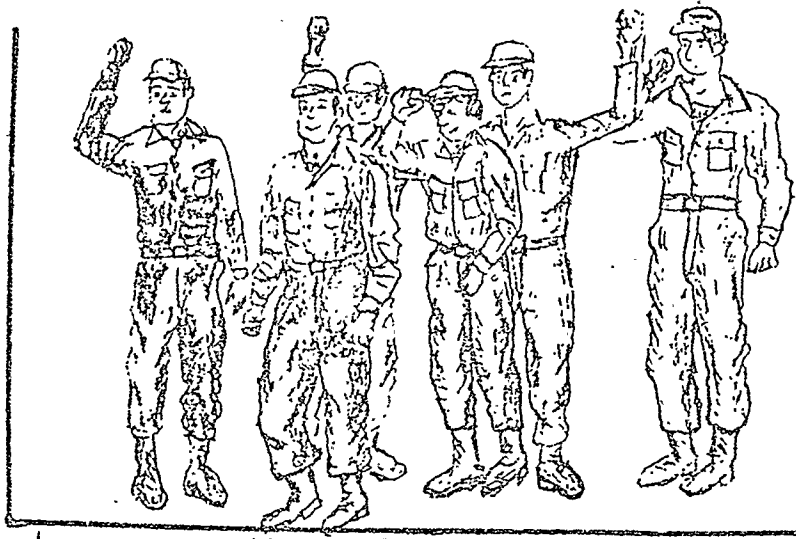

When he tried to return Ozzie was busted. But he was set

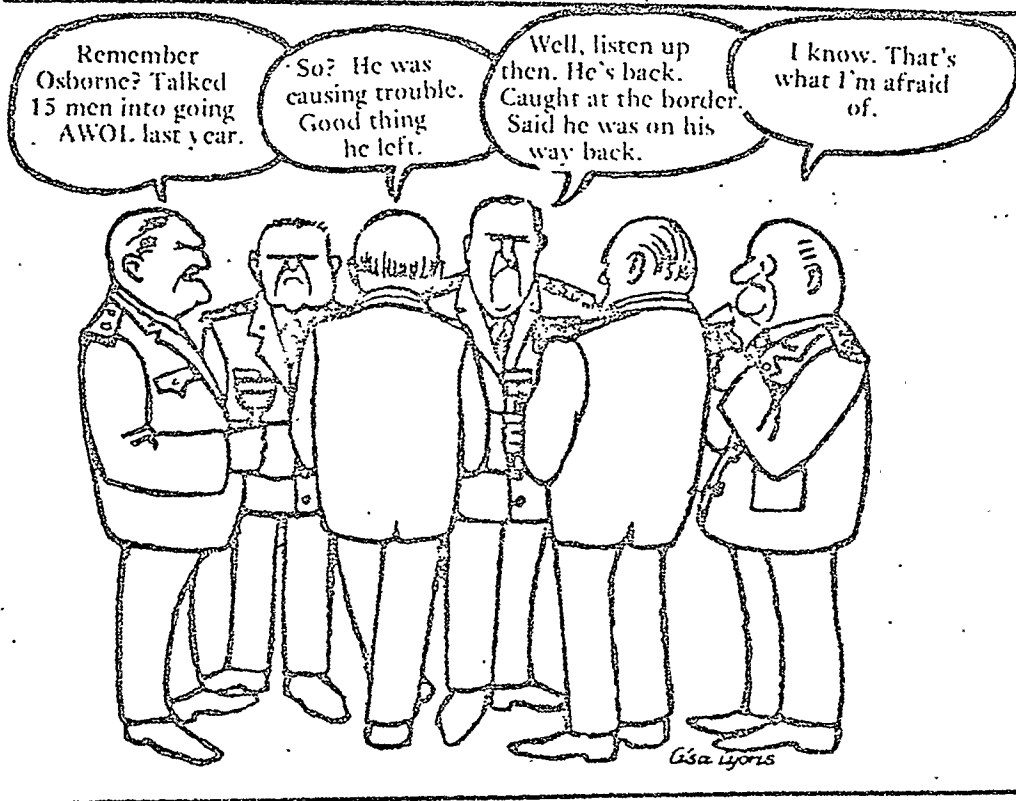

free to await his court-martial for Unauthorized Absence. You see, the lifers in charge had misplaced his records... When Ozzie's file caught up with him, they found out what

his political beliefs were; put him in the brig and charged him with desertion. Ozzie was shafted. He now faces a General Court

PEOPLE'S PEACE TREATY MEETING : FRIDAY AT 7:00 IN THE AZTEC CENTER
FIND OUT HOW YOU CAN HELP IMPLEMENT THIS TREATY AND BRING AN END TO THE WAR

For further information call: from 10 to 4 p.m. call 286-6460

from 5 to 7 p.m. call 291-9487

Substantive parts of the motion on the People's Peace Treaty

We move that this Association (organization, institution) endorse a people's treaty with the people of Viet Nam,

The President of the Association (organization, institution) shall appoint a commission with a mandate

(A) to communicate this motion to the Vietnamese people

(B) to engage in discussions with representatives of the Democratic Republic of Viet Nam, the Provisional Revolutionary Government, other popular forces, and academic colleagues seeking peace and independence in Viet Nam in order to engage in academic cooperation and exchange, and

(C) to study and recommend ways and means to withdraw the resources of this association (organization, institution) from further support from this war.

Prior to May 1, 1971 (a year and a day after the U.S. invasion of Cambodia) this commission shall report to the membership on the progress of its work and of proposals for further action implementing the motion.

Explanatory Material

In opinion polls and in direct tests on the ballot, most recently in Detroit, the American people have shown themselves to favor immediate and total withdrawal from Viet Nam,

Furthermore, the Nixon Administration, aware of this growing majority, has consistently claimed to be ending the war. But the facts are disheartening. Two years have passed. American bombing of Laos has sharply increased. American troops have invaded Cambodia and then left the ARVN to continue open warfare in that previously quiet country, with massive air support from U.S. forces. The devastation of South Viet Nam has continued. And playing upon the anxiety of Americans

At the prisoners held in the North, the U.S. Government has even increased the bombing of North Viet Nam, as well as initiating commando raids. Bombs with destructive power two and one-half times that of the Hiroshima atom bomb are dropped in Viet Nam every week. Apparently the Administration has defined "ending the war" as lowering the level of American battle casualties and the number of American ground troops in Viet Nam to a point that the American people will accept. But this definition permits the indefinite extension of suffering and destruction in Indochina brought by American aerial bombardment and other technology, and ground fighting by Asian mercenaries and conscripts.

At the same time the Nixon Administration has misrepresented the highly volatile political developments in the U.S. - held cities of South Viet Nam, where there has been rising and open opposition to the Thieu-Ky-Kiem regime and to the American presence, by students, war veterans, women, workers, intellectuals, journalists, Buddhists and others. These groups are openly willing to communicate with the NLF, and to enter into a coalition with the Provisional Revolutionary Govt. of South Viet Nam (PRG)

For that reason it is urgent that the PRG proposal (Paris. Sept. 17. 1970) receive fair consideration. It sets forth the following principles as the basis for a just and honorable peace: (1) the total withdrawal of all U.S. military forces from Viet Nam by a date to be specified by the U.S. - perhaps June 30, 1971, as in the Hatfield - McGovern amendment; (2) total withdrawal of all U.S. military and economic support of the Thieu-Ky-Kiem regime; (3) total non-intervention by the U.S. in the internal political affairs of Viet Nam. When these conditions are met the Vietnamese will (1) form a Provisional Coalition Government representing all independent and democratic forces and hold free general elections in all of S. Viet Nam; (2) release immediately all captured soldiers and political prisoners; and (3) refrain from attacking U.S. forces in the process of withdrawal.

The U.S. Government has not taken these steps, nor has it even taken the proposals seriously, so far as anyone knows. The people of Viet Nam and the people of the U.S. both want U.S. withdrawal; with the U.S. Government preventing it, it seems necessary for citizens and for groups to cease depending on the Government and to attempt direct contact with the Vietnamese. The endorsement of the People's Peace Treaty, as proposed in this motion, is the natural way to proceed toward that end.

Date prepared

2/24/71

Date received

2/18/71

Received from (name or symbol number)

SD 1155-R

Received by

SA Steven L. Christensen

Method of delivery (check appropriate blocks)

in person by telephone by mail orally recording device written by Informant

If orally furnished and reduced to writing by Agent:

Date

Dictated

2/19/71

to

G. Kemery

Transcribed

2/23/71

Authenticated by Informant

2/24/71

Date of Report

2/18/71

Date(s) of activity

2/17/71

Brief description of activity or material

Info re MM activities

File where original is located if not attached

* INDIVIDUALS DESIGNATED BY AN ASTERISK (*) ONLY ATTENDED A MEETING AND DID NOT ACTIVELY PARTICIPATE. VIOLENCE OR REVOLUTIONARY ACTIVITIES WERE NOT DISCUSSED.

Information recorded on a card index by _____ on date _____

Remarks:

- 157-1798 (MM)
- 170-286A-91
- 100-14297 (Davis)
- 100-14364 (James Poto)
- 100-91-3149 (De Pugh)
- 100-14015 (Houghton)
- 100-14293 (Clay)
- 157-2224 (Cantrell)
- 3- Phoenix
 - (1- Ev Moore)
 - (1- James Poto)

Index: Ev Moore

Thomas H. Demain
 1 copy of MM letter to
 go in 157-1798
 1 copy of MM letter to
 be kept in info
 want's file

Block Stamp

SEARCHED INDEXED
 SERIALIZED FILED
 FEB 26 1971
 FBI - SAN DIEGO
 170-286A-80

On February 18, 1971
By JEROME

Yesterday I checked the Minutemen Post Office Box in Spring Valley and found an answer to the letter we sent to the new Minutement group in Elgin, Illinois. The envelope was post marked February 8, 1971, and so has probably been in the Post Office Box for several days. The contents were wrapped in true Minutement fashion and copies are attached. I will have to have the original back for future business.

I showed the letter to SAM DAVIS last night. He was fascinated and excited by the letter and immediately called JIM POTO who is back in town from Phoenix, Arizona. POTO, in turn, is suppose to have tried to make arrangements for myself, POTO, and DAVIS to contact EV MOORE, Saturday, February 20, 1971, at the Gun Show in Yuma, Arizona.

MOORE, who resides in Phoenix, is suppose to be a big Minutemen leader who was close up under DE PUGH. He may possibly have been the counter part of TROY HOUGHTON which would have made him the regional coordinator of the Minutemen organization in Arizona. He is said to have some excellent contacts on the east coast.

If it is not possible for us to meet at Yuma, we will then call on MOORE at Phoenix some time in the next couple of weeks.

POTO, who I understand just barely returned from Arizona, has advised that MOORE has been wanting to make some contacts in the San Diego area. According to POTO, possible reasons for this would be that ~~POTO~~ MOORE is tied up with the new group at Elgin, Illinois, and does not want the DE PUGH family to regain control of the organization. Furthermore, it does not appear that the new Minutement group has a regional coordinator for the Southern California area at this time and MOORE may be wanting to find someone to nominate.

Jerome

On February 18, 1971
By JEROME

I understand from talking to SAM DAVIS that we will have access to a printing press large enough to print full size newspapers. This press apparently belongs to BILL CLAY and is the one which was stored in DAVIS' garage for a long time. I do not know where it is now, but POTO claims to know of a secure garage which we can rent for \$6 a month to set the press up in and begin printing. We will see what happens.

I will contact SAM DAVIS again to night before leaving for the Yuma Gun Show. I am suppose to see ISAAC CANTRELL at the Denny's Restaurant in El Cajon at 7:00 p.m., on February 22, 1971.

Jerome

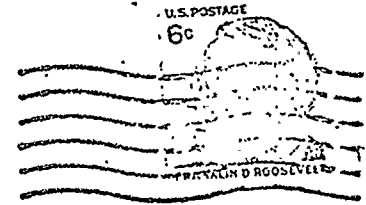

Occupant
P.O.Box 76
Spring Valley, Calif. 92077

National Leaders Praise V.F.W.'s Dedication To America



Vice President Agnew admires the V.F.W. Americanism Award presented to him by Commander-in-Chief Gallagher on behalf of the organization. (E-7)

A SERIES OF SPEAKERS representing the nation's top leadership appeared at the 71st National Convention of the V.F.W. at the Fontainebleau Hotel in Miami Beach, Fla., a reflection of the organization's stature.

Heading the list was Vice President Spiro T. Agnew who called for the V.F.W.'s assistance in defeating the McGovern-Hatfield Amendment that would hasten withdrawal of American troops from Indochina.

Sen. Alan Cranston (Calif.), Chairman of the Senate's Subcommittee on Veterans Affairs, explained the need for increased funds for the VA to operate its system of 166 hospitals.

Donald E. Johnson, Administrator of Veterans Affairs, praised the V.F.W. for its role in urging that veterans benefits be increased and related the strides being made by the VA in caring for the nation's war wounded. (See page 22 for additional details on speeches of Sen. Cranston and Johnson)

Neil Armstrong, recipient of the V.F.W. Space Award, said that "I am no gardener and placing the Flag on the moon was the first thing I have successfully planted."

Armstrong was the first human to walk on the moon.

Kansas City, Mo., Police Chief Clarence M. Kelley, who received the J. Edgar Hoover Gold Medal Award at the Distinguished Guests Banquet Aug. 17, pledged that police would stand at the side of the V.F.W. in protecting the United States.

"Thousands of officers sometimes face the withering fire of assassins," Kelley said. "Some are subjected to taunts and derision and are tested as few are. We accept a changing society, but our forbearance does not extend to treason or revolution.

"We won't stand by idly and let our society crumble from apathy and pernicious permissiveness. We are going to maintain a posture of dignity and protect this matchless land.

"We in law enforcement will be right beside you in the V.F.W. in protecting our beloved country."

Kelley said he accepted the award "not for myself but for the thousands of fine officers who dedicate their lives for peace and tranquility."

Peter J. Brennan, president of the New York Building and Construction Trades Council—one of the "hard hats"—was presented the Gold Medal of Merit.

In accepting the Award, Brennan said the march of the "hard hats" in New York last May "had the support of many other unions and just plain Americans.

"America will still be the greatest country in the world, despite our weaknesses."

Brennan said that the New York parade, which won worldwide attention, consisted of 240,000 persons in downtown Manhattan, while 500,000 watched.

Another New York labor leader who was honored with a Gold Medal Award was Charles Johnson, Jr., president emeritus of the

Carpenters District Council there.

"I cherish this honor above all the others I have received," he said. "When I read what was going on and the way some of our misguided youths had taken to the streets, I thought the average American was too complacent and we should do something.

"Those of us who were born under that Flag and will die under it bought every Flag in New York—50,000 of them—for our demonstration."

Johnson said the right of dissent "does not give anyone in this land the right to disgrace the national emblem, the American Flag."

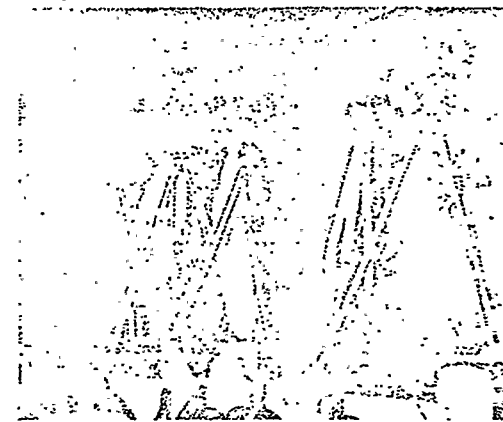

A battery of TV cameramen and newsmen were on hand for the Joint Opening Session. (JO-5)

When it was pointed out that Johnson had recently undergone heart surgery, he said "I would have walked here to receive this award."

Harold Russell, a disabled veteran of World War II and now chairman of the President's Committee on Employment of the Handicapped, presented Commander-in-Chief Raymond A. Gallagher with a citation from President Richard M. Nixon for the V.F.W.'s work on behalf of

(Continued on next page)

Mr. Jerry Moran
P.O.Box 76
Spring Valley, California.
92007



"MINUTEMEN"

P.O. BOX 896
ELGIN, ILLINOIS

February 8, 1971

Mr. Jerry Morgan
P.O. Box 76
Spring Valley, California.

Dear Mr Morgan;

We are most happy to hear from you and to find out that there are still some loyal members left in the San Diego area. We are the same organization minus the family of Bob Depugh and a few of the parasites who moved in on the old National headquarters at Norborne. So there is nothing to do really other than pick up where you left off and continue to work along our original goals.

We have had to increase security somewhat but not too much I hope to prevent us meeting some time in the future. I enclose a february bulletin for your files, Keep us informed as to the situation in your area.

Yours for America,

Tom DeMain

Thomas H. DeMain.
Secretary, National
Coordinating Center.

'MINUTEMEN'

P.O. BOX 896
ELGIN, ILLINOIS

JANUARY BULLETIN



A new year is upon us and there is much to report both good and bad concerning our struggle for a free America.

We will dwell shortly on the bad news first: Many of you have inquired about the fate of Thomas K. Stewart who has been indicted on several counts of Armed Robbery stemming from a series of very successful raids against the Socialist Worker's Party and The Young Socialist Alliance. The trials on all these charges are still pending and Mr. Stewart is out on \$30,000.00 bond at this time. The arrangements of legal council and tactics have kept a number of the staff here at the National Coordinating Center busy for quite some time. The cost of all this as you can well imagine has been very high, but it is our sworn duty to do all we can for Patriots such as Tom Stewart. As for more information about the case, the legal aspects are better if we make no public comment at this time.

Suffice it to say that the cases are heavy on our minds at this time.

The good news is somewhat more extensive, and is as follows:

1. The recruiting drive up and down the east coast is going very well and we will soon be over our goals there.
2. The reorganization of the regions is nearing completion with only several Regional directors left to be appointed.
3. The printing and reprinting of material is proceeding at a slow but steady pace.

As of this time the two most important considerations we have are security and recruiting. We urge all members to try and finish their training Phase as fast as possible, but for the interim we will enclose as part of this Bulletin a copy of Practical Security measures which we feel all members should read and put into practice as soon as possible.

The full report on the S.D.S. Convention which was held in Chicago on December 27th through December 30th. This extensive report will be available to all members for the cost of printing alone.

one who wishes to event identification as a member of this organization should use the use of checks or postal money orders. In modern banking practice all checks are filmed and such records are kept for years. Ordinary cash is the best thing to send because the risk of a small financial loss in the mail is much less than the possible loss of your life when the communists take complete control.

2. Use deceptive measures. Subscribe to one or more left-wing periodicals or get on the mailing list of some 'peace movement'. This will keep the postal inspectors guessing as to which side you are really on. See the December issue of On Target for names and addresses of many left-wing organizations or write to National Headquarters for this information. We are doing this our members can be of great assistance in searching this left-wing literature for names and addresses of fellow travelers and forwarding this information for our Central Intelligence files. We desperately need people to assist in this work. Please inquire as to detailed instructions for such activity.

3. Always use two envelopes in sending mail to any patriotic organization or to any other member of our organization. Do not put a return address on the outer envelope. Put your return address on the inside envelope with the words, "Return postage guaranteed".

4. Place some opaque material such as tin foil, carbon paper, etc. between the inner and outer envelopes to prevent your mail from being read by infra-red cameras.

5. Send all letters from corner mail boxes or from post offices where you are not known.

6. Be careful in the use of the telephone. Avoid telephone calls to National Headquarters or to known members of the organization as much as possible.

7. Prepare telephone codes ahead of time for future protection.

8. In recruiting new members always learn as much as you can about the prospective recruit and make sure he is not an infiltrator before you identify yourself as a member of the organization.

9. Members of the organization in each area should be divided into four groups.

A. Those who have been identified publicly or by law enforcement agencies as members of the Minutemen.

B. Those persons not known as members of this organization but who are generally known as being patriots.

C. Those persons who have kept their political beliefs hidden.

D. Members who profess to be liberal for the purpose of infiltrating enemy organizations.

All members should be very careful in making contact with persons in a different category than themselves. For example, people in Class D should be very secret in their contacts and communications with persons of Class A or Class B. Each member must respect the security of every other member. Do not, under any circumstances, identify one member of the organization even to other members without his expressed permission on each and every occasion.

10. Avoid loose talk. Do not discuss organizational plans in public places where you

Do not write patriotic letters to newspapers or magazines under your own name. To do so achieves very little except to identify you to the enemy.

12. If you are already known as a patriot, or as a member of this organization you may find it advisable to spread the rumor that you have become disillusioned with the right-wing or for you to pretend a gradual loss of interest.

13. Classify your various members addresses, your communications and your other activities as 'top secret', 'secret' or 'restricted'. Use your most secret lines of communication only for the most important messages rather than flooding them with unimportant material.

14. Demand obedience to all security measures from all members. Persistent disregard for security measures should be cause for disciplinary action.

15. Check your lines of communication from time to time by sending phoney messages to make certain they are not intercepted.

16. Change mail drops, meeting places, etc. frequently.

17. Prepare secret rendezvous points, mail drops, etc. now that may be used in time of some future emergency.

18. Each band should assign some member the rank of Security Officer and should set up a system of fines or other penalties for failure to comply with security precautions.

19. Observe the 'need to know' rule. Each member should be given only that information which is needed by him in the performance of his duty or which he will need in cooperating with other members of the band. No member should feel 'left out' because he is denied such information. Instead every member should willingly avoid information which he does not need.

20. Be careful that you are not followed in going to and from meeting places or in making contact with other members of the organization.

21. Keep all records and correspondence carefully hidden and in a manner that they can be easily destroyed. Records should be kept in code whenever possible.

22. Important as secrecy may be, it is not the only essential factor in a successful underground movement. Morale and efficiency are equally important. Elaborate security measures always reduce efficiency to a greater or lesser degree. Unnecessary security can create an atmosphere of suspicion that is devastating to the esprit de corps of any organization. Find a proper balance between security and efficiency.

Monthly Report Form:

I.D. No. if assigned by new coordinator.....

Name if not assigned I.D. No.....

Address if different than one used to mail this letter.....

.....

If you desire to join send name address and phone No.

1. Summarize your activities on behalf of the Minutemen during the last month:

.....

2. What are the needs and requirements of your group; that Headquarters might be able to assist you with.....

3. Do you have any remarks or suggestions.....

4. Have you any New prospective members for the Minutemen, if so give their names and addresses.....

.....

5. How can Headquarters assist you in becoming more active in the operations of the Minutemen? And to help you advance our objectives?.....

.....

6. Are your monthly dues current?.....

We have available at this time all of the training phases for \$2.00 per copy or \$8.00 for the set of five. Also all manuals and bulletins from Norborne since 1961. We are printing every day so if there is some special item you want let us know and we will do our very best.

.....Enclosed \$.....for.....

.....

Monthly dues.....

Legal defense.....

Postage.....

Other.....

TOTAL.....

SAC, SAN DIEGO (157-2177)(P)

3/15/71

SA JOHN O. TRETENEY, JR.

THOMAS LEE FORREST, aka
SM - MM

informant
On 3/5/71, SD 1155-R advised SA STEVEN L. CHRISTENSEN that subject definitely associates with known members of the Minutemen organization in the San Diego area, is ultra-right in his politics, is involved in purchasing and selling of automatic weapons and possibly in the manufacture of them and that he would be hostile to any attempts by FBI Agents to interview him.

- 2 - 157-2177
- 1 - 100-12461
- ① - 170-286-A

2-174
JOI/gar
(4) *gum*

new.

170-2862-81

SEARCHED	INDEXED
SERIALIZED	FILED
MAR 16 1971	
FBI - SAN DIEGO	

16

Date prepared

3/26/71

Date received

2/23/71

Received from (name or symbol number)

Informant
501155-R

Received by

SA Steven L. Christensen

Method of delivery (check appropriate blocks)

in person by telephone by mail orally recording device written by Informant

If orally furnished and reduced to writing by Agent:

Date

Dictated 3/16/71 to Linda Elejido

Transcribed 3/23/71

Authenticated by Informant _____

Date of Report

2/23/71

Date(s) of activity

week ending
2/23/71

Brief description of activity or material

Contacts with Isaac Cantrell & Dave Knorr, Yuma, Arizona Gun Show

File where original is located if not attached

* INDIVIDUALS DESIGNATED BY AN ASTERISK (*) ONLY ATTENDED A MEETING AND DID NOT ACTIVELY PARTICIPATE. VIOLENCE OR REVOLUTIONARY ACTIVITIES WERE NOT DISCUSSED.

Information recorded on a card index by _____ on date _____

Remarks:

157-2224 (Isaac Cantrell)
170-286A-82
157-1798 (AMM)
100-65400 (Jerry Geyer)

Index: Dave Knorr to 157-1798; Bob Kyle + Larry Stork to Geyer's file.

170-286A-82
Block Stamp

SEARCHED INDEXED
SERIALIZED FILED
MAR 2 1971
FBI - SAN DIEGO
[Signature]

ON FEBRUARY 23, 1971
BY JEROME

ISAAC CANTRELL was contacted last night. He said he would make available, 5 or 6 .45 caliber machine gun barrels. He said these can be picked up Friday, the 26th of February, from another person, not CANTRELL. He said he will also make contact with a person in Nevada who owns a mine and who can furnish large quantities of dynamite.

CANTRELL still appears to be paranoid and claims he is followed about three days a week by someone driving a red Datsun or Toyota automobile.

CANTRELL did considerable talking about police officer BUD BENNETT. This is apparently the officer responsible for CANTRELL's recent arrest and CANTRELL hates him intensely. He said he wants to acquire all available information regarding BENNETT such as his home address and telephone number and the license number and description of the automobile which he drives.

CANTRELL also claimed he has a case of dynamite buried in the vicinity of Indio, California.

A right wing individual named DAVE KNORR was contacted last week. He claimed to know of the existence of a group of Minutemen (MM) at Alpine, California. He said these persons are always interested in purchasing weapons.

While at the gun show at Yuma, Arizona, last weekend, he met an individual named BOB KYLE who is supposed to be JERRY GEYER's best friend. KYLE had several magazines for the Russian AK 47 automatic rifle which sold very fast. KYLE's wife is named GINGER. KYLE is about 5'7" tall, dark complexion, dark hair, 30-35 years old. He may work at some local military base as he seems to have excellent access to parts to military weapons. It was mentioned that he does some dealing with Marines at Camp Pendleton.

Another of GEYER's friends who was at the gun show was LARRY STORCH (PH) who had a fairly large number of weapons to sell. He was about 30 years old, 6'2" tall, or taller, dark brown hair. (Possibly identical with LARRY STORTS, a former San Diego police officer who left the department to go to law school.)

Date prepared

3/29/71

Date received

3/9/71

Received from (name or symbol number)

SD 1155-R

Received by

SA Steven L. Christensen

Method of delivery (check appropriate blocks)

in person by telephone by mail orally recording device written by Informant

If orally furnished and reduced to writing by Agent:

Date

Dictated

3/23/71 to Telegino

Transcribed

3/26/71

Authenticated by Informant

Date of Report

3/9/71

Date(s) of activity

3/1/71

Brief description of activity or material

Info re Tray Houghton

File where original is located if not attached

* INDIVIDUALS DESIGNATED BY AN ASTERISK (*) ONLY ATTENDED A MEETING AND DID NOT ACTIVELY PARTICIPATE. VIOLENCE OR REVOLUTIONARY ACTIVITIES WERE NOT DISCUSSED.

Information recorded on a card index by _____ on date _____

Remarks:

100-14015
170-286A-83
100-14297
100-14819

Block Stamp

170-286A-83

SEARCHED INDEXED
SERIALIZED FILED
MAR 10 1971
FBI - SAN DIEGO
Christensen

MARCH 9, 1971

BY JEROME

About 3/1/71, BARRY GODFREY was in contact with SAM DAVIS. Apparently, DAVIS and GODFREY were discussing the disappearance of TROY HOUGHTON. DAVIS mentioned that at some unspecified time, he had talked to a man who he did not identify. He claimed to have been present when HOUGHTON was killed. DAVIS said this man told him HOUGHTON was poisoned with cyanide somewhere in Louisiana and then his body was left in the swamps there.

Jerome

Date prepared

3/29/71

Date received

3/11/71

Received from (name or symbol number)

501155-R

Received by

SA Steven L. Christensen

Method of delivery (check appropriate blocks)

in person by telephone by mail orally recording device written by Informant

If orally furnished and reduced to writing by Agent:

Date

Dictated

3/23/71 to E. Legins

Transcribed

3/26/71

Authenticated by Informant

Date of Report

3/11/71

Date(s) of activity

3/10/71

Brief description of activity or material

info re SD PAC

File where original is located if not attached

* INDIVIDUALS DESIGNATED BY AN ASTERISK (*) ONLY ATTENDED A MEETING AND DID NOT ACTIVELY PARTICIPATE. VIOLENCE OR REVOLUTIONARY ACTIVITIES WERE NOT DISCUSSED.

Information recorded on a card index by _____ on date _____

Remarks:

100-129913 (San Diego Peace Action Coalition)
100-286A-84
100-14293
100-~~129~~14087 (John Somerville)

Block Stamp

170-286A-84
SEARCHED INDEXED
SERIALIZED FILED
APR 1 1971
FBI - SAN DIEGO
Christensen

MARCH 11, 1971

BY JEROME

I was in contact with BILL CLAY yesterday, who furnished me with copies of some literature of the San Diego Peace Action Coalition. All leaflets are signed by JOHN SOMERVILLE and had the address 1426 Merritt Drive, El Cajon, California, telephone 447-1641. The literature indicates this San Diego group is affiliated with the National PAC and furthermore, invites recipients of the literature to a meeting on 3/7/71.

Jerome

Date prepared

3/29/71

Date received

3/10/71

Received from (name or symbol number)

SA DISS-R

Received by

SA Steven L. Christensen

Method of delivery (check appropriate blocks)

in person by telephone by mail orally recording device written by Informant

If orally furnished and reduced to writing by Agent:

Date of Report

3/10/71

Dictated

3/28/71 to Etequino

Transcribed

3/26/71

Authenticated by Informant

Date(s) of activity

3/9/71

Brief description of activity or material

Info re Peter Ruppinger & MM activities

File where original is located if not attached

* INDIVIDUALS DESIGNATED BY AN ASTERISK (*) ONLY ATTENDED A MEETING AND DID NOT ACTIVELY PARTICIPATE. VIOLENCE OR REVOLUTIONARY ACTIVITIES WERE NOT DISCUSSED.

Information recorded on a card index by _____ on date _____

Remarks:

157-1798
170-286A-85
100-14301 (Peter Ruppinger)
100-15337
157-594

Block Stamp

170-286A-85
SEARCHED _____ INDEXED _____
SERIALIZED _____ FILED _____
FBI - SAN DIEGO
Christensen

MARCH 10, 1971
BY JEROME

PETER RUPLINGER was contacted yesterday and the photograph of MORRIS STARSKEY was shown to him. He said that for sometime now, he has been trying to find out who STARSKEY is and has even been following him from time to time looking for a chance to pick up his briefcase. RUPLINGER said he has also been following LEON NOWERS around the campus, the last time being the day before yesterday. He said on that day, NOWERS went to the Student Placement Office, where he reviewed the files maintained there on FBI and CIA employment. He said he believes possibly NOWERS was looking for names of students who are applying or have applied for work with these Government agencies.

There is a rumor going around that the Minutemen may try to stage some opposition to any San Diego area anti-war activities to be held on 4/15/71.

To the best of my knowledge, I have not heard of any MM or other right wingers being involved in a Confederate skirmish unit at Ramona, California, as reported in yesterday's Evening Tribune.

Jerome

Date prepared

3/29/71

Date received

3/9/71

Received from (name or symbol number)

SA 1155-R

Received by

SA Steven L. Christensen

Method of delivery (check appropriate blocks)

in person by telephone by mail orally recording device written by Informant

If orally furnished and reduced to writing by Agent:

Date

Dictated

3/23/71 to Elegino

Transcribed

3/26/71

Authenticated by Informant

Date of Report

3/9/71

Date(s) of activity

3/7-9/71

Brief description of activity or material

MM activities at Gunsnoke Ranch

File where original is located if not attached

* INDIVIDUALS DESIGNATED BY AN ASTERISK (*) ONLY ATTENDED A MEETING AND DID NOT ACTIVELY PARTICIPATE. VIOLENCE OR REVOLUTIONARY ACTIVITIES WERE NOT DISCUSSED.

Information recorded on a card index by _____ on date _____

Remarks:

~~157-1798 (MM)~~
170-286A-86

- 100-14297
- 100-15356
- 100-14610 (Stan Mc Wade)
- 100-14819
- 100-14015
- 100-14016
- 100-15666 (Roger Willis)

Block Stamp

170-286A-86

SEARCHED	INDEXED
SERIALIZED	FILED

FBI - SAN DIEGO
Christensen

MARCH 9, 1971

BY JEROME

It has been learned that last Friday, SAM DAVIS was doing a lot of talking about shooting people. He said even if he eventually leave this area, he will make some trips back for the purpose of eliminating some people. He then said that at one time, he almost killed a girlfriend of GEORGE HOOVER. She was then living at the ranch with HOOVER but returned to Germany, where she was born, when they broke up.

DAVIS said he was in favor of killing her because she apparently knew too much and wanted to set up a shooting accident at the ranch to get rid of her. GEORGE HOOVER vetoed the idea however, and they let her return to Germany.

Last Sunday, at the Gunsmoke Ranch, it was observed that a complex range system has been set up there. There are many people who come there frequently to practice and sometimes there are as many as 50 persons present. Last Sunday, STAN MC DADE and his son, BARRY GODFREY, ROGER WILLIS, a FRANK LNU and 4 other people were there practicing. It was observed that several of these people are quite proficient on the range and in the handling the use of their weapons. He observed that STAN MC DADE and BARRY GODFREY, while digging through a pile of junk on the range, came across a piece of a .50 caliber machine gun, which is interesting.

It is known that BETTIE HOUGHTON has always wanted to be interviewed by FBI about the disappearance of her husband, TROY and now might be even more willing to discuss matters relating to her husband and to DEFUGH.

Jerome

Date prepared

4/13/71

Date received

4/7/71

Received from (name or symbol number)

Informant
SD 1155-12

Received by

SA Steven L. Christensen

Method of delivery (check appropriate blocks)

in person

by telephone

by mail

orally

recording device

written by Informant

If orally furnished and reduced to writing by Agent:

Date

Dictated _____ to _____

Transcribed _____

Authenticated by Informant _____

Date of Report

4/7/71

Date(s) of activity

4/7/71

Brief description of activity or material

4/24/71 Demonst. San Francisco; Star
McDade; Peter Ruppinger

File where original is located if not attached

* INDIVIDUALS DESIGNATED BY AN ASTERISK (*) ONLY ATTENDED A MEETING AND DID NOT ACTIVELY PARTICIPATE. VIOLENCE OR REVOLUTIONARY ACTIVITIES WERE NOT DISCUSSED.

Information recorded on a card index by _____ on date _____

Remarks:

- 170-286A-87
- 100-14356 (Ruppinger)
- 100-15575 (Anti-war Demonstration, San Francisco, 4/24/71)
- 100-14610 (McDade)
- 100-14939 (John Bush)
- 100-14819 (Godfrey)

Index: Howard Cleveland
to 100-14610

Block Stamp

170-286A-87

SEARCHED <input checked="" type="checkbox"/>	INDEXED <input checked="" type="checkbox"/>
SERIALIZED <input checked="" type="checkbox"/>	FILED <input checked="" type="checkbox"/>
APR 11 1971	
FBI - SAN DIEGO	

[Signature]

April 7, 1971

Report of Jerome

PETER RUPLINGER was contacted this morning. He claims that there will be nine buses going from San Diego State to the anti-war demonstration at San Fransisco on the twentyfourth of this month. He said he will find out later from where and when they are leaving and how many people will be on the buses. He knows about the \$900 given the demonstrators by the school and will try to find out if they get any more money from other sources.

STAN MC DADE was also contacted this morning and was accompanied by HOWARD CLEVELAND. It was learned that MC DADE and HOWARD GODFREY were at Camp Pendleton yesterday looking at the scrap parts pile of the Ordnance Disposal unit there. They believe there may be several complete weapons of various kinds which could be made from the scrap parts. For this reason they are considering submitting a bid on the some forty tons of scrap which is to be sold. It was learned that JOHN BUSH is also going to enter a bid.

MC DADE and CLEVELAND indicated they are going to the dexeret in the morning to spend several days doing some shooting and exploring.

Jerome

Date prepared
5/3/71

Date received 4/27/71
Received from (name or symbol number)
Informant
SD 1155-R

Received by
SA Steven L. Christensen

Method of delivery (check appropriate blocks)
 in person by telephone by mail orally recording device written by Informant

If orally furnished and reduced to writing by Agent:
Date _____
Dictated _____ to _____
Transcribed _____
Authenticated by Informant _____

Date of Report
4/27/71

Date(s) of activity
4/26/71

Brief description of activity or material
Sam Davits; Bettie Haughton
Don Carey

File where original is located if not attached

* INDIVIDUALS DESIGNATED BY AN ASTERISK (*) ONLY ATTENDED A MEETING AND DID NOT ACTIVELY PARTICIPATE. VIOLENCE OR REVOLUTIONARY ACTIVITIES WERE NOT DISCUSSED.

Information recorded on a card index by _____ on date _____

Remarks:

- 170-286A-88
- 100-14297 (Davits)
- 100-1614 (Haughton)
- 100-1813 (Haughton)
- 157-1798 (ADM)

Index: Don Carey to
100-14297

Block Stamp

170-286A-88

SEARCHED INDEXED
SERIALIZED FILED

MAY 5 1971
FBI - SAN DIEGO

Christensen

April 27, 1971

BY JEROME

SAM DAVIS was contacted yesterday. He had been to BETTIE HAUGHTON's place and had received from her the complete list of former Minuteman members which was in her possession. She is also going to give him all the field manuals she has, several cases of them, and her medical supplies. SAM said he also believes he knows the identity of the man who helped TROY HAUGHTON bury his caches of weapons and supplies in the Sierras. Included in this stuff is supposed to be an entire packaged Army field hospital which was allegedly stolen from the military. SAM said he will try to get acquainted with this person.

A person named DON CAREY has come to my attention. He is also known as DON VON BECK and HENNING VON BECK. He claims to be the son of a World War II German general named VON BECK. He works as a blaster for Canyon Rock and Gravel Company and has told people he has a cabin near Campo and three rented garages in which he has stored a lot of weapons, parts, ammunition and explosives. He is believed to be a lot of talk. I will try to find out more about him.

Jerome

Date prepared

5/25/71

Date received

5/17/71

Received from (name or symbol number)

~~SA 1155-E~~

Received by

SA Steven L. Christensen

Method of delivery (check appropriate blocks)

in person by telephone by mail orally recording device written by Informant

If orally furnished and reduced to writing by Agent:

Date

Dictated _____ to _____

Transcribed _____

Authenticated by Informant _____

Date of Report

5/17/71

Date(s) of activity

5/17/71

Brief description of activity or material

Info re Ron Zarec & AR Sales

File where original is located if not attached

* INDIVIDUALS DESIGNATED BY AN ASTERISK (*) ONLY ATTENDED A MEETING AND DID NOT ACTIVELY PARTICIPATE. VIOLENCE OR REVOLUTIONARY ACTIVITIES WERE NOT DISCUSSED.

Information recorded on a card index by _____ on date _____

Remarks:

170-286A-89
100-14297 (Davis)
~~100~~-2177 (Tom Forrest)
100-14296 (Conde)

Index: Ron Zarec,
CAR Sales to 100-14297

Block Stamp

170-286A-89

SEARCHED	INDEXED
SERIALIZED	FILED
MAY 26 1971	
FBI - SAN DIEGO	

Christensen

May 17, 1971

Report of Jerome

SAM DAVIS was overheard to say that an individual named RON ZARICK is one of the biggest weapons suppliers in the San Diego area and can usually get anything that SAM asks him for. This is supposed to be one of SAM's contacts who is trying to get him a grease gun or a Sten gun.

It was also learned that a woman named LILLIAN (LNU) is coming down from Los Angeles next week. She is the wife of the owner of A R Sales and will be in town to take an order from SAM for some M-16 conversion kits. A R Sales allegedly has a huge inventory of weapons parts and is also supposed to be dealing in automatic weapons.

SAM claimed to have purchased \$500 worth of M-2 conversion parts from TOM FORREST last month. He indicated that most or all of these parts would go to the Cuban refugees through LOU CONDE.

Jerome

Date prepared

5/25/71

Date received

5/21/71

Received from (name of symbol number)

SD 1153-E

Received by

SA Steven L. Christensen

Method of delivery (check appropriate blocks)

in person by telephone by mail orally recording device written by Informant

If orally furnished and reduced to writing by Agent:

Date

Dictated _____ to _____

Transcribed _____

Authenticated by Informant _____

Date of Report

5/21/71

Date(s) of activity

5/20/71 &
5/21/71

Brief description of activity or material

Gerry Geyer; Joseph Lynn Davis
Lillian Kernes

File where original is located if not attached

* INDIVIDUALS DESIGNATED BY AN ASTERISK (*) ONLY ATTENDED A MEETING AND DID NOT ACTIVELY PARTICIPATE. VIOLENCE OR REVOLUTIONARY ACTIVITIES WERE NOT DISCUSSED.

Information recorded on a card index by _____ on date _____

Remarks:

170-286A - 90
100-15400 (Geyer)
~~100~~¹⁵⁷-2197 (Forrest)
100-14297 (Davis)
100-14819 (Godfrey)
100-14296 (Conde)

Gene Brown &
Index: Lillian Kernes to
100-14297; Bob Kile to
100-15400 (Geyer)

Block Stamp

170-256A-90

SEARCHED	INDEXED
SERIALIZED	FILED
MAY 26 1971	
FBI - SAN DIEGO	

Christensen, J. M.

May 21, 1971

Report of Jerome

It has been learned that HOWARD GODFREY was at Gerry Geyer's house yesterday. GEYER gave GODFREY six booby trap simulators. He hinted he has a contact who may have stolen 3000 Army manuals on booby trap devices being used in Viet Nam. GEYER seems to get most of his material from BOB KILE and TOM FORREST.

I am to contact SAM DAVIS tomorrow morning and then go with him to BETTIE FAUGHTON's house to pick up the field manuals and other supplies she has. We will sort through the manuals for those we want and then sell the rest. any money made from these sales will be given back to BETTIE.

An individual named GENE BROWN is supposed to come down from the Los Angeles area tomorrow afternoon. We will meet him at the Zoo entrance at about 2:00 pm. This is for the purpose of making contact with some of the Right Wing sympathizers at Los Angeles.

The woman from A R Sales is LILLIAN KARNES. A R Sales is making an alloy receiver for the .45 auto pistol, and there was a big write up on the company and the receiver in the last issue of "Guns and Ammo" magazine. It is rumored around that her husband was picked up at one time with 500 machineguns in his possession, so the business is now in the name of his wife and allegedly being run by her.

LILLIAN KARNES is supposed to be a Puerto Rican and SAM thinks she and her company are supplying weapons and other items to the Cuban refugees. This has made SAM interested in contacting the Alpha 66 group, and he wants to go talk to LOU CONDE to see if this can be arranged.

Jerome

Date prepared

6/15/71

Date received

6/8/71

Received from (name or symbol number)

Informant
SD 1155-E

Received by

SA Steven L. Christensen

Method of delivery (check appropriate blocks)

in person by telephone by mail orally recording device written by Informant

If orally furnished and reduced to writing by Agent:

Date

Dictated _____ to _____

Transcribed _____

Authenticated by Informant _____

Date of Report

6/8/71

Date(s) of activity

6/7 + 8/71

Brief description of activity or material

"Doc Roberts"; Barry Godfrey;
Al Delefield

File where original is located if not attached

* INDIVIDUALS DESIGNATED BY AN ASTERISK (*) ONLY ATTENDED A MEETING AND DID NOT ACTIVELY PARTICIPATE. VIOLENCE OR REVOLUTIONARY ACTIVITIES WERE NOT DISCUSSED.

Information recorded on a card index by _____ on date _____

Remarks:

170-286A-91
100-15400 (Geyer)
100-14819 (Godfrey)
100-15061 (YWLH)

Index: Doc Roberts to
100-15400 (Geyer); Al
Delefield to 100-15061

Block Stamp

170-286A-91

SEARCHED <input checked="" type="checkbox"/>	INDEXED <input checked="" type="checkbox"/>
SERIALIZED <input checked="" type="checkbox"/>	FILED <input checked="" type="checkbox"/>
JUN 16 1971	
FBI - SAN DIEGO	
Christensen	

Report by Jerome

June 8, 1971

A person I have heard about before named "Doc Roberts" was in town yesterday morning with 15 assorted military machine guns to deliver to an unknown person. JERRY GEYER was the middle man on this end of the transaction and the deal took place in Lakeside, California. It is not known where or to whom the machine guns went.

It was also learned that BARRY GODFREY will deliver some M-2 parts to JERRY GEYER's house this evening which will be turned over to ROBERTS.

It has also been learned that AL DELLEFIELD of Los Angeles, California, will be in town on June 11, 1971. He is described as the press secretary for the Southern California Young Workers Liberation League. He is to deliver a speech presented by the Peoples World and sponsored by a group known as Freedom of the Press Committee located in El Cajon, California, with telephone number 442-5843. DELLEFIELD will speak about the Peoples World and ways to increase the circulation of that paper.

A speech is scheduled for Room 11 of the Conference Hall, Balboa Park, at 8:00 p.m. on June 11, 1971.

Jerome

Date prepared

6/23/71

Date received

6/17/71

Received from (name or symbol number)

Informant
SD 1155-E

Received by

SA Steven L. Christensen

Method of delivery (check appropriate blocks)

in person by telephone by mail orally recording device written by Informant

If orally furnished and reduced to writing by Agent:
Date

Dictated _____ to _____

Transcribed _____

Authenticated by Informant _____

Date of Report

6/17/71

Date(s) of activity

6/17/71

Brief description of activity or material

Ron Zarec; Josephina Davis;
Bettie Haughton

File where original is located if not attached

* INDIVIDUALS DESIGNATED BY AN ASTERISK (*) ONLY ATTENDED A MEETING AND DID NOT ACTIVELY PARTICIPATE. VIOLENCE OR REVOLUTIONARY ACTIVITIES WERE NOT DISCUSSED.

Information recorded on a card index by _____ on date _____

Remarks:

170-286A-92
100-14297 (Davis)
100-14819 (Godfrey)
157-1614 (Haughton)
157-28 (ANP)
105-3220 (States Rights Party)
157-1813 (Haughton)

Index: Ron Zarec to
100-14297; Joseph
Cotton to ~~100~~ 157-1813
(Haughton).

Xerox copy made
for 157-2921

Block Stamp

170-286A-92

SEARCHED	INDEXED
SERIALIZED	FILED
JUN 25 1971	
FBI - SAN DIEGO	

Christensen

June 17, 1971

BY JEROME

met with ZAREC today. He is employed in the garden shop at the Sears store in El Cajon. His home phone number is 441-1111. He offered me an M-2 kit which I turned down. He indicated he is a big dealer in ammunition. SAM DAVIS has told me he is also a good contact for all types of weapons and related supplies. ZAREC doesn't know I am acquainted with Davis.

ZAREC appears to have considerable money. He talked about the upcoming gun show in Pasadena and warned that the ATF may attempt to make some arrests there. I am planning to go to the show as there are supposed to be some meetings of people associated with the NSWPP and the SRP afterwards.

SAM DAVIS mentioned the other day he had been talking to BETTIE HAWKINTON and JOSEPH COTTON who runs a Right Wing program in the Los Angeles area. BETTIE still believes ROBERT DE PUGH to have been responsible for the death of TROY HAUGHTON. She indicated she has some witnesses and allegedly has filled out an affidavit recently with everything but the witnesses' names. She wants to file charges DE PUGH and have him tried for TROY's death.

Jerome

SAC (174-428)(P)

7/6/71

SA EARL M. PETERSEN

JERRY LYNN DAVIS, aka;
EUGENE BROWN;
BOMBING MATTER

At 8:25 a.m. 7/5/71, the writer contacted ^{informant} SD 1155-R at which time he stated that he had just gotten off work at 8:00 a.m. after working an eight hour shift. He said he had read in the paper the article concerning the bombing of an IRS office at San Jose, California but that he has heard nothing from DAVIS or BROWN.

During the forenoon of 7/5/71, STEVE LOGAN of ATFD, IRS, telephoned and asked the writer to contact source and have him contact DAVIS to see what DAVIS had to say and to see if he was in San Diego. After clearing this with Supervisor #4, source was contacted and he said he would contact DAVIS on some pretext.

Informant drove to DAVIS's house and enroute he was stopped by the Highway Patrol who checked out his identification. They gave him no ticket. When source parked about a block from DAVIS's house, a San Diego County Sheriff car drove up and checked his license plate by stopping behind his car. This was observed by DAVIS and his mother who was ~~visiting~~ visiting him. When source entered the DAVIS residence, the mother stated that she had told her son that she figured source was a friend of his since he brought "the fuzz" with him.

DAVIS and source had a long conversation about whether BROWN had participated in the bombing of the IRS building in San Jose. They observed that he had said he only had black powder and fire-bombs but felt that plenty of ammonium nitrate was easily available and that he could possibly have used this explosive. Neither of them had any first hand information concerning the bombing.

DAVIS suggested that they lay low for a while because of the bombing in San Jose.

① - 170-286A
EMP:emp
(3)

93
170-286A-57

SEARCHED	INDEXED
SERIALIZED	FILED
FBI - SAN DIEGO	

Date prepared

7/16/71

Date received

7/14/71

Received from (name or symbol number)

SD 1155-E

Received by

SA Steven H. Christensen

Method of delivery (check appropriate blocks)

in person by telephone by mail orally recording device written by Informant

If orally furnished and reduced to writing by Agent:

Date

Date of Report

7/14/71

Date(s) of activity

7/14/71

File where original is located if not attached.

Brief description of activity or material

Sam Davis; ANP; Stan McDade
Troy Haughton; Bettie Haughton

* INDIVIDUALS DESIGNATED BY AN ASTERISK (*) ONLY ATTENDED A MEETING AND DID NOT ACTIVELY PARTICIPATE. VIOLENCE OR REVOLUTIONARY ACTIVITIES WERE NOT DISCUSSED.

Information recorded on a card index by _____ on date _____

Remarks:

170-286A-94
100-14297 (Davis)
157-28 (ANP)
100-14610 (McDade)
157
~~100~~-1614 (Haughton)
157
~~100~~-1813 "

Block Stamp

70-286A-94

SEARCHED	INDEXED
SERIALIZED <u>B</u>	FILED <u>B</u>
JUL 19 1971	
FBI - SAN DIEGO	

Christensen

July 14, 1971

REPORT BY JEROME

I was in telephone contact with SAM DAVIS today. He appears to be very hooked on joining the American Nazi Party. STAN MC DADE is the one who is pushing the hardest on joining the Nazis. I understand that DAVIS and MC DADE will get together to look for office space for the Nazi Party headquarters in the San Diego area.

DAVIS also said he is going out tomorrow to find some office equipment, for this purpose. He said there is a possibility that the local group may get some financial help from the Nazi Party at Los Angeles.

DAVIS also advised he knows of the whereabouts of one of TROY HAUGHTON's old hideouts. He said this hideout is still in tact and usable and that he, DAVIS, might have to make use of it himself if things get to hot for him in San Diego. He mentioned that HAUGHTON stayed in this hideout for a long period of time on one occasion when the police department was looking for him. It was thought that he was not in town because they had been unable to find him. DAVIS said, to the best of his knowledge, the location of the hideout is now known only to him and BETTIE HAUGHTON.

n

Jerome

Date prepared

7/16/71

Date received

7/1/71

Received from (name or symbol number)

~~Informant~~
SD 1153-E *

Received by

SA Steven L. Christensen

Method of delivery (check appropriate blocks)

in person by telephone by mail orally recording device written by Informant

If orally furnished and reduced to writing by Agent:
Date

Dictated _____ to _____

Transcribed _____

Authenticated by Informant _____

Date of Report

7/1/71

Date(s) of activity

7/1/71

Brief description of activity or material

Tom Forrest; Garry Geyer;
theft of (alleged) Navy knives

File where original is located if not attached

* INDIVIDUALS DESIGNATED BY AN ASTERISK (*) ONLY ATTENDED A MEETING AND DID NOT ACTIVELY PARTICIPATE. VIOLENCE OR REVOLUTIONARY ACTIVITIES WERE NOT DISCUSSED.

Information recorded on a card index by _____ on date _____

Remarks:

170-286A-96
~~157~~ -2177 (Forrest)
100-15400 (Geyer)

Index: Bob Kyle to
100-15400 (Geyer)

170-286A-96
Block Stamp

SEARCHED INDEXED
SERIALIZED FILED
JUL 19 1971
FBI - SAN DIEGO
Christensen Jll

July 1, 1971

REPORT BY JEROME

I learned today of the recent theft of a large number, more than 2,000, of U.S. Navy Mark I sheath knives. It was indicated to me that TOM FORREST has 300 of these knives, Ski's Swap Shop (owned by FNU SKIBOWSKI) near 40th and University, bought a large number of them and has a few personally and openly on display. BOB KYLE reportedly sold several 100 to the Patch and Ball Gun Shop. An individual known as "Little Joe" is said to have several 100 of these knives and JERRY GEYER says that he has a lot of several 100 of the knives staked out which he is attempting to acquire.

Jerome

UNITED STATES GOVERNMENT

Memorandum

TO : SAC, SAN DIEGO (174-4280)

DATE: 8/3/71

FROM : SA STEVEN L. CHRISTENSEN

SUBJECT: JERRY LYNN DAVIS, aka;
EUGENE BROWN
BOMBING MATTER

On the evening of 8/2/71 ^{informant} SD 1155-R was contacted at which time he advised that Subject DAVIS had told him that day he was temporarily unemployed and was in a desperate need of money. DAVIS indicated that he would be willing to sell most of the explosive materials given by him to the informant at the following prices:

Box of 50 electric blasting caps	\$20.00
Box of 100 fuse blasting caps (two)	10.00 (both)
1 pound max block of TNT	6.00
1/2 pound block of TNT	3.00
plastic bag of TNT prills	5.00
Hand grenade fuzes - 13 @ \$4.50	81.00
M2 trip levers - 35 @ \$2.50	87.50
Rifle grenade - empty	4.00
Rifle grenade - charged, yellow smoke	5.00
Ammunition cans - 4 @ 1.00	4.00
XXXXXX Total	\$216.50 225.50

Informant advised that DAVIS would want returned to him the camouflage uniform, the blasting cap crimpers, the three military electric blasting caps for detonating composition "C" explosives, the fifteen loose, time delay, electric blasting caps, and the remainder of the fix rifle parts.

On 8/3/71 Special Investigator STEVE LOGAN, ATFD, was contacted regarding this matter and whether ATFD would be willing to allow the return of the foregoing items to DAVIS through the informant, with the blasting caps being deactivated or inert caps substituted. LOGAN then telephonically contacted his supervisor, RICHARD JOHNSON, ATFD, Santa Ana. It was the concurrent opinion of both JOHNSON and LOGAN that the items which ~~max~~ DAVIS will want returned to him, with the exception of the blasting caps, do not represent any violation of law under the jurisdiction of ATFD, and, under normal circumstances would be returned to the owner anyway. With regard to the blasting caps, in view of remote possibility of prosecution

2 - SD 174-428
1 - SD 170-236A
1 - SD 100-14297
SLC/slc
(4)

- 170-236A-98

SEARCHED	INDEXED
SERIALIZED	FILED
AUG 10 1971	
FBI - SAN DIEGO	

Buy U.S. Savings Bonds Regularly on the Payroll Savings Plan

in this matter, they interposed no objection to returning to DAVIS deactivated or inert blasting caps, feeling that the record of their possession by the Government and disposition would serve as well for evidence purposes as having the caps themselves.

On 8/3/71 SGT. WILLIAM BIRCH, 70th Ordnance Detachment (EOD), Fort. Rosecrans, San Diego, California, advised that there is no effective way that the blasting caps in question could be deactivated without extreme danger to the attempting this action and without it being obvious that the caps had been tampered with. SGT. BIRCH advised that the manufacturers of all such blasting caps make inert caps ~~which~~ for training and identification purposes which are indistinguishable from the live ones. He said that in his opinion the best course of action would be to obtain such inert caps to substitute for the ones now in the possession of the Government. He said that the best source of information as to where to obtain these substitutes would be the Institute of Makers of Explosives, 420 Lexington Ave., New York City, 10017.

Memorandum

TO : SAC, SAN DIEGO (100-14297)

DATE: 9/20/71

FROM : SA STEVEN L. CHRISTENSEN

SUBJECT: JERRY LYNN DAVIS, aka
EX - MM

On this date ^{informant} SD(1155-E) advised he was at a meeting on the evening of 9/19/71 which was also attended by Subject, HOWARD CLARK and one ED ANDREWS.

Among other things discussed source learned that Subject apparently obtained from CLARK the residence address of SA ARNOLD W. O'BRIEN, which information DAVIS has long sought. Source is not aware how CLARK may have obtained this address or whether it is in fact SA O'BRIEN's correct address. He said the information was apparently over one year old. He said he believes he will be able to obtain this address from DAVIS within the next day or two.

- 1 - SD 100-14297 (JERRY LYNN DAVIS)
 - ① - SD 170-286 A
 - 1 - SD 157- (HOWARD CLARK)
 - 1 - SD 157- (ED ANDREWS)
- SLC/s lc
(4)

170-256A-99

SEARCHED	INDEXED
SERIALIZED	FILED
SEP 21 1971	
FBI - SAN DIEGO	

an



Buy U.S. Savings Bonds Regularly on the Payroll Savings Plan

UNITED STATES GOVERNMENT

Memorandum

TO : SAC, SAN DIEGO (157-2224)

DATE: 10/6/71

FROM : SA STEVEN L. CHRISTENSEN

SUBJECT: ISAAC WILLIAM CANTRELL
E - MM

On 10/5/71, ^{informant} SD 1155-E advised he has been attempting to contact the Subject, unsuccessfully, and has come to the conclusion CANTRELL has left the San Diego area.

On 10/6/71, ^{CONF SOURCE} Miss JEAN HARRISON, clerk, US Postal Inspector's Office, San Diego, advised her records contain a forwarding address for Subject dated 5/27/71, showing a change from Alpine, California, to P.O. Box 1104, Fabens, Texas 79338.

Foregoing submitted for information only.

① - SD 170-286 A
1 - SD 157-2224
SLC/slc
(2)

170-286-A-100

SEARCHED _____	INDEXED _____
SERIALIZED _____	FILED _____
OCT 27 1971	
FBI - SAN DIEGO	



Buy U.S. Savings Bonds Regularly on the Payroll Savings Plan

Date prepared

3/29/71

Date received

3/26/71

Received from (Name or symbol number)

~~SD 1155-E~~

Received by

SA STEVEN L. CHRISTENSEN

Method of delivery (check appropriate blocks)

in person by telephone by mail orally recording device written by Informant

If orally furnished and reduced to writing by Agent:

Date

Date of Report

3/26/71

Dictated

to

SA

Date(s) of activity

3/26 and 27/71

Transcribed

Authenticated
by Informant

Brief description of activity or material

Info regarding JERRY LYNN DAVIS,
MC DADE and PAUL RUPLINGER.

File where original is located if not attached

* INDIVIDUALS DESIGNATED BY AN ASTERISK (*) ONLY ATTENDED A MEETING AND DID NOT ACTIVELY PARTICIPATE. VIOLENCE OR REVOLUTIONARY ACTIVITIES WERE NOT DISCUSSED.

Information recorded on a card index by _____ on date _____

Remarks:

100-14297 DAVIS
100-14610 MC DADE
100-14301 RUPLINGER
~~170-286A - 101~~
100-14819 GODEREY

Block Stamp

170-286A-101

SEARCHED INDEXED
SERIALIZED FILED

MAR 31 1971
FBI - SAN DIEGO

[Handwritten signatures and initials]

JEROME
3/26/71

I was in contact with PAUL RUPLINGER. He continued to be interested in creating disturbances and offered to take Right Wing leaders for a drive along Interstate 8 to show them where they could use dynamite on underpasses and overpasses to create the most disruption. It has been learned that SAM DAVIS and BARRY GODFREY may drive up to Los Angeles tomorrow to contact the people who own and run AR Sales, for the purpose of finding out about the availability of military manuals and various weapons.

DAVIS, GODFREY and MC DADE continue to talk about setting up a new organization to handle Right Wing activities in the San Diego area. Arrangements have been made for them to meet soon at a drive-in restaurant to talk about ways and means of setting up such an organization with a legal defense fund, a newspaper or bulletin and harassment activities.

Date prepared

4/9/71

Date received

3/31/71

Received from (name or symbol number)

SD 1155-E

Received by

SA STEVEN L. CHRISTENSEN

Method of delivery (check appropriate blocks)

in person by telephone by mail orally recording device written by Informant

If orally furnished and reduced to writing by Agent:
Date

Date of Report

3/31/71

Dictated _____ to _____

Date(s) of activity

3/31 - 4/4/71

Transcribed _____

Authenticated by Informant _____

Brief description of activity or material

~~American Legion March in downtown San Diego on 4/4/71.~~

File where original is located if not attached

* INDIVIDUALS DESIGNATED BY AN ASTERISK (*) ONLY ATTENDED A MEETING AND DID NOT ACTIVELY PARTICIPATE. VIOLENCE OR REVOLUTIONARY ACTIVITIES WERE NOT DISCUSSED.

Information recorded on a card index by _____ on date _____

Remarks:

170-286a-102
157-1798 (Minutemen)

170-286A-102
Block Stamp

SEARCHED INDEXED
SERIALIZED FILED
MAY - 3 1971
FBI - SAN DIEGO
A. [Signature]

JEROME
3/31/71

I have heard there will be an American Legion march in downtown San Diego on Sunday, 4/4/71, to protest the court-martial of Lt. WILLIAM CALLEY. This march is being sponsored partially by Radio Station KSON and all Right Wing groups in the San Diego area are being urged to join in. A call has been put out for 50,000 participants and to the best of my knowledge, no parade permit has been obtained from the San Diego Police Department. I was in contact with one of the women who is pushing the march. She has telephone 276-6648. According to her, the march will start about 12 NOON from the Navy Recreation Field at Harbor Drive and Market Street, will proceed up Harbor Drive to 8th Avenue, from there to Broadway and then back to Harbor Drive and the Recreation Field for a rally. The woman told me they have received 3700 phone calls since last night. She said the march seems to be getting much support from the military, adding that two Generals and three Colonels have indicated they will participate in the march in full uniform.

Date prepared

4/9/71

Date received

4/2/71

Received from (name or symbol number)

SD 1155-E

Received by

SA STEVEN L. CHRISTENSEN

Method of delivery (check appropriate blocks)

in person by telephone by mail orally recording device written by Informant

If orally furnished and reduced to writing by Agent:

Date

Dictated

to

Handwritten initials

Transcribed

Authenticated
by Informant

Date of Report

4/2/71

Date(s) of activity

4/1 and 2/71

Brief description of activity or material

INFO re JERRY LYNN DAVIS

File where original is located if not attached

* INDIVIDUALS DESIGNATED BY AN ASTERISK (*) ONLY ATTENDED A MEETING AND DID NOT ACTIVELY PARTICIPATE. VIOLENCE OR REVOLUTIONARY ACTIVITIES WERE NOT DISCUSSED.

Information recorded on a card index by _____ on date _____

Remarks:

170-286A-103
100-14297 DAVIS

170-286A-103
Block Stamp

SEARCHED INDEXED
SERIALIZED FILED
MAY 1 1971
FBI - SAN DIEGO
Handwritten signature

Handwritten mark

JEROME
4/2/71

I was in contact with SAM DAVIS last night. He claimed to have received a call earlier in the evening from the Klu Klux Klan in Mississippi. The only explanation he would give is that something he was involved in there broke open and he is afraid he may be arrested soon. If so, he says he knows who is responsible and he will take care of them later. However, he is very shaken up and has been talking about going underground until the problem blows over. In the past he has claimed to have been involved in robberies, burglaries, and illegal weapons deals which may account for what he is afraid of now.

However, if he is still in town on Sunday, he will join in the march protesting the trial of Lt. CALLEY and may try to start a confrontation if people show up to demonstrate against the march.

Date prepared

4/9/71

Date received

4/4/71

Received from (name or symbol number)

Informant
SA 1155-E

Received by

SA STEVEN L. CHRISTENSEN

Method of delivery (check appropriate blocks)

in person by telephone by mail orally recording device written by Informant

If orally furnished and reduced to writing by Agent:
Date

Date of Report

4/4/71

Dictated _____ to *D*

Date(s) of activity

4/3 - 4/71

Transcribed _____

Authenticated by Informant _____

Brief description of activity or material

INFO re travel of JERRY LYNN DAVIS and GEORGE HOOVER to Arizona

File where original is located if not attached

* INDIVIDUALS DESIGNATED BY AN ASTERISK (*) ONLY ATTENDED A MEETING AND DID NOT ACTIVELY PARTICIPATE. VIOLENCE OR REVOLUTIONARY ACTIVITIES WERE NOT DISCUSSED.

Information recorded on a card index by _____ on date _____

Remarks:

170-286A-104

- 100-14297 DAVIS
- 100-15356 HOVER
- 100-14293 CLAY
- 100-14819 GODFREY

2-100-EV MOORE (O & A)

INDEX *D*
EV MOORE to ~~DAVIS file~~

Block Stamp

170-286A-104

SEARCHED INDEXED

SERIALIZED FILED

APR 10 1971

FBI - SAN ANTONIO

[Handwritten signature]

[Handwritten mark]

JEROME
4/4/71

It has been learned that SAM DAVIS and GEORGE HOOVER left yesterday morning to go to a construction project in Arizona. They intend to make use of this trip to make contacts with people they know or have heard of in Las Vegas, Phoenix, and El Paso. They are supposed to call back after making these contacts. DAVIS left his brief-case with BARRY GODFREY and because of what happened in Mississippi, was talking about the possibility of going underground but sneaking back to the San Diego area later on.

The person to be contacted in Phoenix is EV MOORE.

DAVIS claims that of the Right Wing groups that are still intact, the one at Las Vegas is the best run and is already functioning. He said it is supposed to have Mafia connections and is also the best source of many kinds of supplies.

DAVIS wants the San Diego area Post Office Box which was rented in BILL CLAY's name dropped and a new Post Office Box rented so that CLAY cannot get at the mail.

Date prepared

5/11/71

Date received

5/5/71

Received from (name or symbol number)

~~SD 1155-E~~

Received by

SA CHRISTENSEN (STEVEN)

Method of delivery (check appropriate blocks)

in person by telephone by mail orally recording device written by Informant

If orally furnished and reduced to writing by Agent:

Date

Date of Report

5/5/71

Dictated

to

o.w.

Transcribed

Authenticated by Informant

Date(s) of activity

5/4 and 5/71

Brief description of activity or material

Info re firearms activities
of JERRY LYNN DAVIS and BARRY GODFREY

File where original is located if not attached

* INDIVIDUALS DESIGNATED BY AN ASTERISK (*) ONLY ATTENDED A MEETING AND DID NOT ACTIVELY PARTICIPATE. VIOLENCE OR REVOLUTIONARY ACTIVITIES WERE NOT DISCUSSED.

Information recorded on a card index by _____ on date _____

Remarks:

170-286A-105

100-14297 DAVIS ~~XXXXXXXXXX~~

157-~~157-1798~~ BETTIE HAUGHTON

157-1798 Minuteman

100-14819 GODFREY

157-2177 Tom Forrest

2-157-

DON CAREY, aka (O & A)

Index 0

DON CAREY, aka

Don Von Beck, Henning Von Beck
to 157-1798

157-1798-57

170-286A-105

Block Stamp

SEARCHED *[initials]*

SERIALIZED *[initials]*

MAY - 3 1971

FBI - SAN DIEGO

[Handwritten signature]

[Handwritten mark]

JEROME
5/5/71

I was in contact with SAM DAVIS yesterday. He had come from BETTIE HAUGHTON's place. She gave him the entire former Minuteman membership list which she had in her possession, along with cases of field manuals and other literature as well as a large quantity of medical supplies and items. DAVIS seems to think he knows the name of the person who helped TROY HAUGHTON bury many of his supplies in the Sierras, included among which is supposed to be a whole packaged Army field hospital which they stole somewhere.

I have come across an individual named DON CAREY. He is also known as DON VON BECK and to some people as HENNING VON BECK. He claims to be the son of the German World War II General named VON BECK. He is a blaster for Canyon Rock and Gravel Company. He impresses me as being a big talker but claims to have a cabin at Campo and three rented garages full of weapons, including machine guns, weapons parts, ammunition and explosives.

SAM claims that he can order me a Sten gun for \$100. He also says that TOM FORREST is one of his two San Diego suppliers but that he makes most of his purchases in Washington and Oregon. DAVIS claims he has been dealing with FORREST for about 6 - 8 months and claims to have recently purchased \$500 worth of M-2 carbine parts from FORREST for the purpose of making short M-2 "enforcers".

According to what DAVIS has been saying, FORREST appears to have contacts with military personnel at Camp Pendleton through which he makes weekly raids on armories and the supplies there. DAVIS has apparently asked BARRY GODFREY to go with him to Camp Pendleton to show him the location of the scrap parts pile of the ordnance disposal unit on that base.

DAVIS continues to talk about and work on the Right Wing organization he wants to establish. His idea is to contact people he knows in Phoenix, Seattle, Portland, and Las Vegas and have individuals in all those cities give out a press release announcing the formation of the new organization.

In addition, leaflets and stickers will be put out the same day and post office boxes for the organization retred in all these cities on the same day so as to completely disguise the location of the national headquarters which will be in San Diego, with DAVIS and GODFREY running the thing. He wants to structure the organization along military lines with military ranks and training for the purpose of creating a Right wing organization to overthrow the government in this country.

Date prepared

11/10/71

Date received

11/4/71

Received from (name or symbol number)

SD 1155-E

Received by

SA Steven L. Christensen

Method of delivery (check appropriate blocks)

in person by telephone by mail orally recording device written by Informant

If orally furnished and reduced to writing by Agent:

Date

Dictated

to

Transcribed

Authenticated by Informant

Date of Report

11/4/71

Date(s) of activity

11/3-4/71

Brief description of activity or material

Info re Hoover, McWade, Nazi Party, Rev. Gale, Marge McNichols, Patriotic Party, Barry Goldwater

File where original is located if not attached

170-286A

* INDIVIDUALS DESIGNATED BY AN ASTERISK (*) ONLY ATTENDED A MEETING AND DID NOT ACTIVELY PARTICIPATE. VIOLENCE OR REVOLUTIONARY ACTIVITIES WERE NOT DISCUSSED.

Information recorded on a card index by _____ on date _____

Remarks:

170-286A-106

9-823

100-14819 (Goldwater)

157-1818 (McNichols)

100-14610 (McWade)

100-13832 (Patriotic Party)

157-1798 (MM)

157-28 (Nazi Party)

100-15356 (Hoover)

100-15355 (Busch)

157-201 (Smith)

2 - Los Angeles

Index: Reverend Gale &

9-349 - Marge McNichols to 157-1818

Block Stamp

170-286A-106

SEARCHED INDEXED SERIALIZED FILED
NOV 1 1971
FBI - SAN DIEGO
A. L. ...

m

November 4, 1971
By "Jerome"

I was told by Barry Godfrey that he and George Hoover went by Peace House #1 at 2143 Market Street last night. Godfrey said the place appeared to be unoccupied at the time and when he and Hoover looked inside, saw it to be full of books and other literature, and all kinds of materials. They also claimed to have driven by the house at 3121 Beech which Godfrey said is a big house at the corner of the street.

Godfrey also stated that Hoover, Stan McDade, and Jerry Lee Busch, went to a meeting of Gerald Lee Smith's Nazi Party group last night. Hoover was wearing the uniform of the new group he is trying to organize. This organization will be a branch of the Missionary Church of Jesus Christ headed by Reverend Gale at Los Angeles, California.

While at the meeting, because of some internal trouble, and because they liked Hoover's uniform better than the Nazi uniform, most of Smith's group decided to leave the Nazi Party organization and join Hoover's new group.

I don't know anything about a Reverend Pike or Peak, but the Reverend Gale may be the same one who is head of Missionary Church of Jesus Christ at Los Angeles. Gale comes to town about once a month to fulfill a speaking assignment here. He has Nazi and anti-Semitic tendencies although he is not known to me as being a member of the Nazi Party.

Also, I have heard nothing about threatening telephone calls being made by anyone locally to obtain the release of the Patriotic Party members in Michigan; however, Margaret L. McNichols, who lives at 2113 Whispering Pines Drive in Julian, is closely acquainted with the individuals in Michigan named Freed. At one time, she told me she and Freed both belonged to some German club and showed me a photograph of her and Freed together at a meeting in Santa Ana, California.

Page two

McNichols claimed to have been the Secretary-Treasurer of the Western Region of the Patriotic Party, covering 11 western states and is also a close associate of Robert Bolivar DePugh. McNichols is also acquainted with Reverend Gale, who has been connected with the Patriotic Party.

McNichols and her husband, Leo, own and operate a grocery store on Main Street in Julian named the Mountain Market. Leo McNichols is, or was employed by the FAA at Julian.

I believe that Margaret McNichols is the type of person who might make threatening telephone calls in behalf of members of the Patriotic Party, but do not know if she has actually done this.

Date prepared

1/6/72

Date received

6/14/71

Received from (name of symbol number)

Informant
SD 1153-E

Received by

SA Steven L. Christensen

Method of delivery (check appropriate blocks)

in person by telephone by mail orally recording device written by Informant

If orally furnished and reduced to writing by Agent:

Date

Dictated _____ to _____

Transcribed _____

Authenticated by Informant _____

Date of Report

6/14/71

Date(s) of activity

6/13/71

Brief description of activity or material

Info re conversation of Barry Godfrey & Sam Davis

File where original is located if not attached

* INDIVIDUALS DESIGNATED BY AN ASTERISK (*) ONLY ATTENDED A MEETING AND DID NOT ACTIVELY PARTICIPATE. VIOLENCE OR REVOLUTIONARY ACTIVITIES WERE NOT DISCUSSED.

Information recorded on a card index by _____ on date _____

Remarks:

- 100-14819 (Godfrey)
- 100-14297 (Davis)
- 157-1614 (Haughton)
- 160-15356 (Hoover)
- 157-1813 (Bettie Haughton)
- 157-1728 (MM)

Pertinent info previously disseminated.

Index: Paul Hunt, Dennis Mower, Mary Toller-ton to 157-1614

170-286A - 107

Of

Block Stamp

170-286A-107

SEARCHED INDEXED

SERIALIZED FILED

JAN 15 1972

FBI - OHIO

Christensen MP

June 14, 1971
BY JEROME

I was talking with BARRY GODFREY last night. He said he had just spent sometime with SAM DAVIS the same evening and that DAVIS admitted to being a total anarchist. He said that DAVIS thinks that the U.S. government is as much an enemy of the people, meaning right wing conservatives as the left wing movement is. He said DAVIS is still interested in attempting to formulate a new organization to take the place of the old Minuteman Group. BARRY said DAVIS wants to set up 2 right wing groups, one, an open group which would conduct intelligence type operations and the other a covert group which would conduct sabotage and harassment and obtain such things as explosives and machine guns.

GODFREY said the conversation with DAVIS got around to TROY HOUGHTON and DAVIS said he has known for two years what actually happened to HOUGHTON and added that BETTY HOUGHTON has also had the same information. According to DAVIS, a meeting was held at which BETTY HOUGHTON, DAVIS, PAUL HUNT, DENNIS MOWER, GEORGE HOOVER, and one other unidentified individual were present. The meeting was held for the purpose of hearing an oral report from MARY TOLLERTON as to what had happened to TROY HOUGHTON, that he had been held prisoner by ROBERT DE PUGH in the basement of DE PUGH's house with the help of WALTER PEYSON.

June 14, 1971
By JEROME

HOUGHTON was then poisoned to death and his body disposed of somewhere in the State of Missouri. After the meeting, BETTY HOUGHTON was in favor of making all this information public and requesting a grand jury investigation of DE PUGH and PEYSON for her husband's death. However, the other people present at the meeting talked her out of this close of action.

GODFREY then said DAVIS told him that he knows of a total of five people who were killed by DE PUGH, including TROY HOUGHTON. He said two of these were killed after HOUGHTON's death to keep his murder quiet. DAVIS said that MARY TOLLERTON was being hidden in the Los Angeles area for quite a while by DENNIS MOWER, PAUL HUNT and others as there was thought DE PUGH was looking for her to kill her. Some how, she got away from MOWER and HUNT for a period of about six months but then they got her back again. Allegedly, BETTY HOUGHTON told MOWER to keep track of MARY TOLLERTON at all cost even if he had to marry her.

According to DAVIS, it is his belief HOUGHTON was killed by DE PUGH as DE PUGH thought HOUGHTON had already contacted the FBI or was in the process of arranging such a contact for the purpose of informing on DE PUGH's activities.

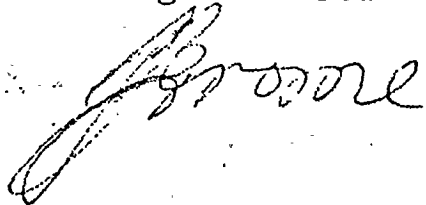

Date prepared

1/5/71

Date received

6/15/71

Received from (name of symbol number)

SD 1155-E

Received by

SA Steven L. Christensen

Method of delivery (check appropriate blocks)

in person by telephone by mail orally recording device written by Informant

If orally furnished and reduced to writing by Agent:

Date

Dictated _____ to _____

Transcribed _____

Authenticated by Informant _____

Date of Report

6/15/71

Date(s) of activity

6/15/71

Brief description of activity or material

Info re Ron Zarick; NSWPP
NSRP

File where original is located if not attached

* INDIVIDUALS DESIGNATED BY AN ASTERISK (*) ONLY ATTENDED A MEETING AND DID NOT ACTIVELY PARTICIPATE. VIOLENCE OR REVOLUTIONARY ACTIVITIES WERE NOT DISCUSSED.

Information recorded on a card index by _____ on date _____

Remarks:

52-5212
~~157~~ (Ron Zarick) (manipulative)
157-28 (NSWPP)
100-14297 (Sam Davis)
105-3220 (NSRP)
157-1728 (MM)
100-14819 (Godfrey) Erf

Relevant info previously disseminated

170-286A-108

Block Stamp

170-286A-108
SEARCHED _____ INDEXED _____
SERIALIZED _____ FILED _____
JAN 6 1971
FBI - OMAHA
Christensen ME

June 15, 1971
By JEROME

This morning, I met an individual named RON ZARICK who was attempting to sell military ammunitions of several calibers. I will try to find out more about him later.

I also learned that there were 12 members of the NSWPP at the anti-war demonstration at NEL Center yesterday. SAM DAVIS may also have been there as he appeared to know a lot about it. DAVIS has had a project going to get himself fired from his job and may already have been successful. If so, He will go on unemployment and then on welfare in order to be able to devote full time to his right wing activities. He has approached me about going to a meeting at Los Angeles in the next few days with representatives of the Minutemen organization, the States Right Party, and the NSWPP for the purpose of discussing the possibility of an alliance of these groups. He mentioned that the national leader of the States Rights Party may be at the meeting. I will try to find out more about this also.

I also learned that DAVIS wants to set up a course of instruction in the use of explosives which would start off with a group composed of BARRY GODFREY and two men selected by him and SAM DAVIS and two men selected by him .

Jerome

Date prepared

1/5/72

Date received

6/21/71

Received from (name or symbol number)

Informant
SD 1155-E

Received by

Steven L. Christensen

Method of delivery (check appropriate blocks)

in person by telephone by mail orally recording device written by Informant

If orally furnished and reduced to writing by Agent:
Date

Date of Report

6/21/71

Dictated _____ to _____

Date(s) of activity

6/21/71

Transcribed _____

Authenticated by Informant _____

Brief description of activity or material

Gen'l info re right wing activists.

File where original is located if not attached

* INDIVIDUALS DESIGNATED BY AN ASTERISK (*) ONLY ATTENDED A MEETING AND DID NOT ACTIVELY PARTICIPATE. VIOLENCE OR REVOLUTIONARY ACTIVITIES WERE NOT DISCUSSED.

Information recorded on a card index by _____ on date _____

Remarks:

- 100-14297 (Davis)
- 157-2832 (Don Carey)
- ~~100~~ 157-1820 (Frank Yacopac)
- 100-14292 (Brinker)
- 100-14610 (McDade)
- 100-14939 (John Bush)
- 170-286A-109

Pertinent info previous disseminated.

(Index:

Ron Hunicutt, Rick Lindsay, Bob Robinson
Alex Rapidprint to
100-14297

of

Block Stamp

170-286A-109

SEARCHED INDEXED
SERIALIZED FILED

JAN 6 1972
FBI - SAN DIEGO

Christensen

June 21, 1971
BY JEROME

The person I have recently come into contact with is RON HUNICUTT who lives on 37th Street in San Diego. He allegedly has some .45 caliber automatic pistol receivers with the serial numbers ground off. BOB ROBINSON, a telephone company employee, had one which he looked at not too long ago. Apparently, HUNICUTT is a big dealer in guns, ~~and is known to SAM DAVIS by a different name.~~

Another person who is ^{an} ~~a close~~ associate of SAM DAVIS is DON CAREY, ⁱⁿ ~~another~~ individual by the name of RICK LINDSAY, ^{a SD PD officer} ~~who has been acting as a go-between for~~ ROBINSON and CAREY, ^{is a friend of both} ~~who is known to Davis by another name.~~

I also understand that CAREY took an examination for employment with the U. S. Border Patrol not too long ago. He has been hinting of knowledge of the whereabouts of M-60 machine gun which he described as a good riot gun. He is also trying to become "friends" with DAN DWYER, who operates a gun smithing shop on Washington in San Diego and who is well known to SAM DAVIS.

ALEX RAPIDPRINT has been doing the plates for some of the new forms and other printed material for the local right wing group.

FRANK YACOPEC continues to do well after having been in the hospital for removal of kidney stones.

June 21, 1971
By JEROME

I was at STAN MC DADE's place on Saturday and
JOSEPH BRINKER showed up there.

I was also in touch with JOHN BUSH who offered
me an action for an anti-tank rifle for \$45.00.

Jerome

Date prepared

1/6/92

Date received

6/23/91

Received from (name or symbol number)

~~SD/155-E~~

Received by

Steven h. Christensen

Method of delivery (check appropriate blocks)

in person by telephone by mail orally recording device written by Informant

If orally furnished and reduced to writing by Agent:

Date

Dictated _____ to _____

Transcribed _____

Authenticated
by Informant _____

Date of Report

6/23/91

Date(s) of activity

6/22/91

Brief description of activity or material

Conversation with Paul

Ruplinger & General Leutney

File where original is located if not attached

* INDIVIDUALS DESIGNATED BY AN ASTERISK (*) ONLY ATTENDED A MEETING AND DID NOT ACTIVELY PARTICIPATE. VIOLENCE OR REVOLUTIONARY ACTIVITIES WERE NOT DISCUSSED.

Information recorded on a card index by _____ on date _____

Remarks:

- 100-14301 (Ruplinger)
- 100-14299 (Davis)
- ~~157-5212~~ (Ron Zarick)
- 100-14819 (Godfrey)
- 157-28 (NSW RP)
- 100-14303 (Watson)
- ~~100-105-348~~ (Bertram Comperet)

Pertinent info previously disseminated

Index: General Leutney to 100-14301.

Scott Winchester to 157-28 - also see Tomasi

170-286A-110

of

Block Stamp

170-286A-110

SEARCHED _____ INDEXED _____

SERIALIZED _____ FILED _____

JAN 1992

FBI - SAN DIEGO

Christensen - Me

JUNE 23, 1971
BY JEROME

I was in conversation with PAUL RUPLINGER and General LEMLEY yesterday. LEMLEY said he has some M-16 rifles and has been giving weapons to all of his neighbors for self defense.

LEMLEY is extremely militant and I understand that he, RUPLINGER, and perhaps SAM DAVIS refused to fill out the U.S. Census Forms which they received and expected to be arrested shortly and placed in jail.

LEMLEY says that lots of weapons and other items of military equipment are coming down to the U.S. out of Canada. LEMLEY was extremely upset at the arrests made by ATFD and local law enforcement officers at the Pasadena Gun Show on 6/19/71. He said he was going to contact the headquarters of the John Birch Society (which he is deeply involved in) at San Marino, and have that organization check into the arrests. PAUL RUPLINGER was also very upset about the situation.

It should be noted that in talking with RON ZARICK before the gun show took place, he warned me to be cautious at the gun show as he had received word that the ATFD and State officials were planning to make arrests at the show.

It has come to my attention that both SAM DAVIS and BARRY GODFREY are fairly well acquainted with SCOTT WINCHESTER, leader of the Nazi Party Group, Bishop Faction, at Los Angeles, California.

JUNE 23, 1971
BY JEROME

WINCHESTER appears to be a near kook. He was one of the more active participants in the anti-war demonstration sponsored by MDM at Oceanside, California, in May, 1970. He was running around like a roving idiot and screaming, "fascist pigs" at the police.

SAM DAVIS says he heard that the NSWPP at San Diego might favor a split from the NSWPP at Los Angeles which is headed by (FNU) TOMASCO and join up with WINCHESTER's group. If this happens, it will take place through the efforts of VIC WALTON or BERTRAM COMPARET.

Joe Tomasi
Jerome

Date prepared

1/6/72

Date received

9/12/71

Received from (name or symbol number)

informant
SD 1155-E

Received by

Steven L. Christensen

Method of delivery (check appropriate blocks)

in person by telephone by mail orally recording device written by Informant

If orally furnished and reduced to writing by Agent:

Date

Dictated _____ to _____

Transcribed _____

Authenticated by Informant _____

Date of Report

9/12/71

Date(s) of activity

9/12/71

Brief description of activity or material

Info re Sam Davis, NSWPP,
Harvey, Mc Dade, Poto, Godfrey
etc.

File where original is located if not attached

* INDIVIDUALS DESIGNATED BY AN ASTERISK (*) ONLY ATTENDED A MEETING AND DID NOT ACTIVELY PARTICIPATE. VIOLENCE OR REVOLUTIONARY ACTIVITIES WERE NOT DISCUSSED.

Information recorded on a card index by _____ on date _____

Remarks:

- 100-14297 (Davis)
- 157-28 (NSWPP)
- 100-14819 (Godfrey)
- 157-1816 (James Poto)
- ~~100-14610 (Roger Willis)~~
- 100-14610 (Mc Dade)
- 157-201 (Smith)

Relevant info previously disseminated.
Index Scott Winchester
American Socialist Workers Party to 157-28
Roger Willis to 100-14297

170-286A-111

of

Block Stamp

170-286A-111

SEARCHED	INDEXED
SERIALIZED	FILED

JAN 6 1972
FBI - SAN DIEGO
Christensen

July 12, 1971

REPORT BY JEROME

I was in contact with SAM DAVIS this morning. He finally got his wish and was fired from his job. He did not go to work as he was supposed to this morning and while I was at his house his boss called saying that he had some important jobs for DAVIS to take care of. He said if DAVIS could not be more reliable, he, the boss, would have to find someone else to do the job. DAVIS then told him to go ahead and find someone else whereupon his boss hung up. DAVIS said he has another job to go to in the middle of next week for one ROGER (LNU). This job will last approximately one month following which DAVIS will be laid off and then can claim unemployment and welfare while devoting full time to his activities. He believes he can draw unemployment for a period of approximately six months. He talked again about the explosives and other materials which he has and some of which he has given to me.

He said he has come across opportunities to buy other such materials at fairly low cost and, therefore, wants to sell some of the stuff he now has to get money to buy these other materials and also to help the Nazi Party out financially.

DAVIS stated that it is his intention to join the American Nazi Party and showed me his membership application form. It is my understanding that the local Nazi group which has, in the past, been part of the National Socialist White Peoples Party (NSWPP), will switch allegiance in the near future to the Bishop Faction of the American Nazi Party now headed up by SCOTT WINCHESTER at Los Angeles, California.

If and when this takes place, the name they apparently will use for the new group is American Socialist Workers Party.

DAVIS is all excited about buying uniforms and other things to get ready to go on "storm trooper" duty. He said he is going to try and get all of his associates, including GEORGE HOOVER, STAN MC DADE, JAMES POTO, BARRY GODFREY, ROGER WILLIS and "AL" (LNU) to join also.

According to DAVIS, the Nazi Party group which he has been hearing so much about lately is only a segment of the total Nazi group in the San Diego area. GERALD L. K. SMITH, the leader of this active group, is apparently only what is called a section leader. There are apparently several sections of the Nazi Party group in San Diego and overall leader for the whole group.

DAVIS said that he and three other people, one of whom will probably be STAN MC DADE and the other two members of the NSWPP in San Diego, will go to Los Angeles soon to see SCOTT WINCHESTER and make arrangements for merging with his group.

DAVIS says that the Nazi Party group is good on organizing but poor on weapons acquisition and intelligence work. He said he expects to be of considerable help to the Nazis in these two areas.

He said he has been in contact with BARRY GODFREY and had asked him to do some work on compiling a list of liberal members of the Jewish community in San Diego as a starting point for harassment and other tactics by the Nazis. He said that the Nazis have been using DON SISCO's Militants Formulary as a handbook for training in explosives etc. He said SISCO himself is reported to be a section leader for either the Bishop Faction of the Nazi Party or the NSWPP.

DAVIS' telephone number is listed in the directory under B. L. GIBSON at 2393 Washington, Lemon Grove, California. The telephone number is 465-9572.

DAVIS indicated that he has been offered 100 grenade bodies with the necessary parts to make live weapons from them for a sum of \$25.00.

This morning I observed all the parts of a disassembled .30 caliber Browning air-cooled machine gun in the back room of the Bullseye Gun Shop.

Jerome

Date prepared

1/6/72

Date received

7/20/71

Received from (name or symbol number)

~~Informant~~
SD-152-E

Received by

Steven H. Christensen

Method of delivery (check appropriate blocks)

in person by telephone by mail orally recording device written by Informant

If orally furnished and reduced to writing by Agent:

Date

Date of Report

7/20/71

Dictated

to

Date(s) of activity

7/18/71 - 7/21/71

Transcribed

Authenticated by Informant

Brief description of activity or material

Info re Sam Davis, Barry Godfrey, NSWPP

File where original is located if not attached

* INDIVIDUALS DESIGNATED BY AN ASTERISK (*) ONLY ATTENDED A MEETING AND DID NOT ACTIVELY PARTICIPATE. VIOLENCE OR REVOLUTIONARY ACTIVITIES WERE NOT DISCUSSED.

Information recorded on a card index by _____ on date _____

Remarks:

- 100-14297 (Davis)
- 100-14819 (Godfrey)
- 157-201 (Smith)
- 157-28 (NSWPP)
- 100-14610 (McDade)
- 170-286A-112

Relevant info previously disseminated.

Block Stamp

170-286A-112

SEARCHED _____ INDEXED _____

SERIALIZED _____ FILED _____

JAN 6 1972

FBI - OHIO DIVISION

Christensen

July 20, 1971

By JEROME

SAM DAVIS says he has an operation in mind for this weekend. He said he wants BARRY GODFREY to provide six men; DAVIS will provide another six and the NSWPP will furnish 12 men to conduct a raid on a faculty office at UCSD, where a Viet Cong Flag is supposed to be hanging. The purpose of the raid will be to seize the flag, take it out on the campus, and burn it in front of as large a crowd as they can get.

DAVIS said he is also trying to get ahold of a white phosphorous grenade for another project he has in mind for the weekend, but would not even hint as to what he is thinking of using it for.

I went to a recent meeting of the NSWPP with STAN MC DADE. GERALD L. SMITH was speaking. One of the other people at the meeting had a medal for what is referred to by the American Nazi Party as the "Virginia Campaign", which occurred in 1958. These medals were awarded by GEORGE LINCOLN ROCKWELL, which would indicate that the person I saw at the meeting must be a longtime Nazi Party member. This individual

Page Two

said he is going to Los Angeles soon with MC DADE and SMITH to meet with Nazi Party Officials there.

MC DADE has been gathering a big list of Jews for the NSWPP and was asking about the location of a good uniform shop as he wants to buy a Khaki Uniform to wear to meetings.

Jerome

Date prepared

1/6/72

Date received

7/21/71

Received from (name or symbol number)

Informant
SD 155-E

Received by

Steven L. Christensen

Method of delivery (check appropriate blocks)

in person by telephone by mail orally recording device written by Informant

If orally furnished and reduced to writing by Agent:

Date

Dictated _____ to _____

Transcribed _____

Authenticated by Informant _____

Date of Report

7/21/71

Date(s) of activity

7/20-21/71

Brief description of activity or material

Info re Peter Ruppinger &
Tom Forrest

File where original is located if not attached

* INDIVIDUALS DESIGNATED BY AN ASTERISK (*) ONLY ATTENDED A MEETING AND DID NOT ACTIVELY PARTICIPATE. VIOLENCE OR REVOLUTIONARY ACTIVITIES WERE NOT DISCUSSED.

Information recorded on a card index by _____ on date _____

Remarks:

100-14356 (Ruppinger)
100-14819 (Goatrey)
157-2177 (Tom Forrest)
~~157-52-5212 (Ron Zarick)~~

170-286A-113

Pertinent info previously disseminated
Index Dick Gould
Lewy Brown, Bill
Guelte, Chuck
Pierce to 157-

Block Stamp

170-286A-113

SEARCHED _____ INDEXED _____

SERIALIZED _____ FILED _____

JAN 6 1972

FBI - SAN DIEGO

[Handwritten signatures]

July 21, 1971

By JEROME

It appears that PETER RUPLINGER has a friend in a small arms arsenal or depot on one of the local Navy Bases. He has been offering the sale of four M-2 conversion kits, and says he thinks he will be able to furnish all the small arms including grenades and possibly a light .30 caliber machine gun that anyone would want. He was asking BARY GODFREY if GODFREY could obtain a tear gas grenade which RUPLINGER wants for the purpose of throwing into the "Bedroom", a local night club offering nude entertainment.

I saw TOM FORREST yesterday and while there observed a .45 caliber grease gun with two full magazines.

Some time ago I met a person named DICK GOULD. Yesterday I saw him again and he offered me a sawed off shotgun and another shotgun which had been made into a pistol. He wanted \$50 for both of the weapons but did not have them with him for me to look at. I will try to find out more about GOULD.

Page Two

Another person I have heard a lot about is one LARRY BROWN. He apparently used to live close to me and some friends were telling me at one time about what a nut and raving maniac he is. He apparently has moved to Poway. Yesterday while I was at Bulls Eye Gun Shop BILL GUIETTE was telling me about some work he was doing on a nine millimeter German Schmeitzer. Today I was in Bulls Eyes again and met this LARRY BROWN and talked to him for about one hour. He was telling me all about his nine millimeter German Schmeitzer and hinted that he may have some other automatic weapons. Very likely the Schmeitzer GUIETTE was working on belonged to BROWN. I will also try to find out more about BROWN.

CHUCK PIERCE, ~~the San Diego John Birch Society leader,~~ lives at 8527 Goldenridge Road, Lakeside, California, and has telephone number 449-4176. He and BILL GUIETTE have been talking about joining the U.S. Army, Special Forces, Reserve Unit in San Diego, purely for the purpose of seeing what items of equipment they can steal.

This reserve unit is already supposed to be very heavy with right wing nuts and there are rumors that a lot of weapons and other equipment are already coming out

Page Three

of that outfit. I was also in contact with RON ZARICK again. He offered to sell me 2000 rounds of .30-06 ammunition at 5¢ a round and told me that he also has 30,000 rounds of .30 carbine ammunition.

J. P. [unclear]

Date prepared

1/6/72

Date received

7/13/71

Received from (name or symbol number)

Informant
SD 1155-E

Received by

Steven L. Christensen

Method of delivery (check appropriate blocks)

in person by telephone by mail orally recording device written by Informant

If orally furnished and reduced to writing by Agent:

Date

Date of Report

7/13/71

Dictated _____ to _____

Date(s) of activity

7/13/71

Transcribed _____

Authenticated by Informant _____

Brief description of activity or material

Info re Rick Burns

File where original is located if not attached

* INDIVIDUALS DESIGNATED BY AN ASTERISK (*) ONLY ATTENDED A MEETING AND DID NOT ACTIVELY PARTICIPATE. VIOLENCE OR REVOLUTIONARY ACTIVITIES WERE NOT DISCUSSED.

Information recorded on a card index by _____ on date _____

Remarks:

100-

(Rick Burns) (new info file)

170-286A-114

g

Block Stamp

170-286A 114

SEARCHED	INDEXED
SERIALIZED	FILED
JAN 15 1972	
FBI - SAN DIEGO	

[Handwritten signatures and initials]

July 13, 1971
By JEROME

It has come to my attention that there is an individual who may be of interest who works for the San Diego Fire Department and is assigned to Station 13 in La Jolla. His name is RICK BURNS and he has been overheard to make statements which are highly pro-Russian and pro-Communist China. He saves up his money and vacation time and travels to Russia each summer.

BURNS apparently lives in the La Jolla area as he walks to work every morning. He is about 27, 5'11", 180 husky build. He has light brown hair, a ruddy complexion, wears reading glasses, is married and has a collie dog. He allegedly served in the U.S. Marine Corps and has been with the Fire Department for about four and one half years.

Jerome

Date prepared

1/6/72

Date received

7/13/71

Received from (name or symbol number)

Informant
SD 1155-E

Received by

Steven H. Christensen

Method of delivery (check appropriate blocks)

in person by telephone by mail orally recording device written by Informant

If orally furnished and reduced to writing by Agent:

Date

Date of Report

7/13/71

Date(s) of activity

Dictated _____ to _____

Transcribed _____

Authenticated by Informant _____

Brief description of activity or material

Info re Peter Reptinger

File where original is located if not attached

* INDIVIDUALS DESIGNATED BY AN ASTERISK (*) ONLY ATTENDED A MEETING AND DID NOT ACTIVELY PARTICIPATE. VIOLENCE OR REVOLUTIONARY ACTIVITIES WERE NOT DISCUSSED.

Information recorded on a card index by _____ on date _____

Remarks:

100 - 14356 (Reptinger)
170 - 286A - 115

Relevant info previously disseminated.
Index Phillip Saluato to 100 - 14356

af

Block Stamp

170 - 286A - 115
SEARCHED INDEXED
SERIALIZED FILED
JAN 6 1972
FBI - SAN DIEGO
[Signature]

July 13, 1971

REPORT BY JEROME

Yesterday I was in contact with PETER RUPLINGER. He is still self employed as a wholesale diamond dealer. He said one of his customers is allegedly an Italian who has connections with the local tuna fishing association and with the Mafia. He said he had acquired from this person a rifle with a silencer which he told RUPLINGER was a Mafia assassination weapon. He obtained this rifle from RUPLINGER yesterday evening for \$20.00. The rifle is a British Enfield bolt action rifle and a .303 caliber. It has been heavily modified with an extension having been added to the butt stock and the parts of the receiver assembly missing exposing the internal working mechanism. The rear sight is also missing.

The breech ends of the receiver and barrel on this rifle are usually threaded with a square cut thread. However on this rifle, these parts both have a regular toothed machine thread which was obviously done to allow the rifle to be disassembled into two pieces.

The forestock of the rifle is also missing and a device, reported to be a silencer, has been added to the breech end of the barrel. This device is approximately 2" in diameter and 5" long and cylindrical in shape. There is a $\frac{1}{2}$ " diameter aluminum tube extending from the forward bottom part of this device along the barrel almost to the muzzle. Attached to the muzzle is the regular issue British flash suppressor for use on the Enfield .303 caliber carbine. Most of the metal parts of the rifle have been coated with black lacquer.

When assembled, the rifle does not headspace properly which is apparently due to the threads being worn or a necessary shim missing.

I recontacted RUPLINGER this morning and learned that the individual he obtained the rifle from is one PHILLIP SALUATO, 6766 Rose Field Drive, San Diego, California. RUPLINGER said SALUATO allegedly has other weapons including Thompson submachine guns and M-2 carbines which he will sell. RUPLINGER also said that the silenced

rifle which he sold me was supposedly delivered to SALUATO by the Mafia for destruction or permanent disposal. He said SALUATO, who is apparently eager to make a fast buck, apparently decided to sell the weapon rather than destroy it.

From my knowledge of RUPLINGER, I suspect it is very likely he enlarged considerably on this story.

Jerome

Date prepared

8/6/72

Date received

7/28/71

Received from (name or symbol number)

SD/155-E

Received by

Steven L. Christensen

Method of delivery (check appropriate blocks)

in person

by telephone

by mail

orally

recording device

written by Informant

If orally furnished and reduced to writing by Agent:

Date

Dictated

to

Transcribed

Authenticated
by Informant

Date of Report

7/28/71

Date(s) of activity

7/28/71

Brief description of activity or material

Info re NSWPP

File where original is located if not attached

* INDIVIDUALS DESIGNATED BY AN ASTERISK (*) ONLY ATTENDED A MEETING AND DID NOT ACTIVELY PARTICIPATE. VIOLENCE OR REVOLUTIONARY ACTIVITIES WERE NOT DISCUSSED.

Information recorded on a card index by _____ on date _____

Remarks:

157-28 (NSWPP)
100-14297 (Davis)
157-1816 (Poto)
170-286A-116

Pertinent info previously disseminated.
Index (FAM) Roth to 157-28.

cf

Block Stamp

170-286A-116
SEARCHED INDEXED
SERIALIZED FILED
JAN 6 1972
FBI - SAN DIEGO
[Signature]

July 28, 1971

By JEROME

It has come to my attention that one of the ~~main~~ NSWPP organizers in San Diego County is a person named (FNU) ROTH. He has been described as a uniformed and card carrying member of the Nazi Party and has allegedly done much organizing for that group in the Oceanside, California, area.

I have also learned that SAM DAVIS and JIM POTO have been asked to go to Arizona within the next few weeks to meet with some unnamed person there.

Jerome

Date prepared

1/7/72

Date received

7/26/71

Received from (name or symbol number)

SA [unclear] 570/155-E

Received by

Steven L. Christensen

Method of delivery (check appropriate blocks)

in person by telephone by mail orally recording device written by Informant

If orally furnished and reduced to writing by Agent:

Date

Date of Report

7/26/71

Dictated _____ to _____

Date(s) of activity

7/25/71

Transcribed _____

Authenticated by Informant _____

Brief description of activity or material

Info re San Diego, NSWPP,
Frank Yakofec

File where original is located if not attached

* INDIVIDUALS DESIGNATED BY AN ASTERISK (*) ONLY ATTENDED A MEETING AND DID NOT ACTIVELY PARTICIPATE. VIOLENCE OR REVOLUTIONARY ACTIVITIES WERE NOT DISCUSSED.

Information recorded on a card index by _____ on date _____

Remarks:

170-286A-117

100-14297 (Davis)

157-28 (NSWPP)

100-14303 (Watson)

~~157-1820~~ (Yakofec)

157- (Robert S. Mayer) (new)

52-5212 (Ron Zarick)

100-14819 (Godfrey)

100-15356 (Hooder)

Pertinent info previously furnished & handled.
Index Bill Gullette to 52-5212. Dr. O'Dunkley to 100-15356
GKA

1/20/72
SA Christensen was instructed to expedite prep. of FD-306s and to see me if there are other problems. Christensen also advised to promptly disseminate all pertinent info to local offices or USSJ and to follow procedure set forth in 176-26-183.

Block Stamp

170-286A-117

SEARCHED [initials] INDEXED [initials]
SERIALIZED [initials] FILED [initials]
JAN 1 1972
FBI - SAN DIEGO
Christensen [signature]

July 26, 1971

By Jerome

I was in contact with SAM DAVIS again yesterday and he mentioned again his favorite project which is to fill some rifle grenades with thermite and explosives and to fire them onto the top of several gasoline and oil storage tanks, among those which are located in Mission Valley near the intersection of Murphy Canyon Road and Firars Road. He said he believes the results will be spectacular and that he will not permanently leave the San Diego area without completing this project.

DAVIS continues to be extremely interested in the local Nazi Party group and said he wants to work for a high position in this organization. He says that VIC WALTON is deeply involved in the NSWPP, but even though, he still does not trust WALTON. He said he is going ahead with plans to locate and rent office space for the NSWPP and also set up a printing press for that group.

DAVIS also talked about another plan which is being worked on to attempt to seize a Viet Cong flag which is hanging in an office at UCSD. He said at least he would like

to make an effort to put a smoke grenade through the window of this office. He said he has been talking with the NSWPP about taking 15 members of that group along to protect the person who would fire this rifle grenade through the window. He said the results would be better yet if a high explosive grenade was used. He advised that the NSWPP and others he is associated with are suppose to have some LAWs (Light Anti-tank Weapons) which they might use.

FRANK YACOPEC has been fired again. He now has a boarder living with him who was recently discharged from the Marine Corps. This individual is named ROBERT S. MAYER. He claims to be well acquainted with the firearm ranges at Camp Pendleton and knows of an ammo dump there which he says has only one guard who could easily be over-powered, and that, by using a two ton truck, it would be possible to take over a million rounds of ammo from this location. MAYER also claims to have a .45 caliber Thompson sub-machine gun, and M-16 and M-14 rifles which he would sell.

BILL GUIETTE, who runs the Bullseye Gun Store was set up in that business by his father who is a Sergeant with the San Diego Police Department. GUIETTE was telling me today that he was at RON ZARICK's house a few days ago and saw there many parts for various machine guns. Yesterday SAM DAVIS said he was at ZARICK's house some time ago

and while there, saw a M-14 rifle, a water-cooled .30 caliber machine gun and a BAR.

DAVIS claims that he is somewhat upset with BARRY GODFREY, as he gave GODFREY an assignment to watch the San Diego FBI Office to obtain information regarding the activities of the local FBI. DAVIS said he might use GEORGE HOOVER to stake out the FBI Office if he is presently out of work on a fake back injury. The disability chits and this fake injury were signed by Dr. DUNKLEY in El Cajon, who has agreed to take care of any MM or other right wing individual wounded in a confrontation the Left or with law enforcement agencies without filing the necessary reports and without charging a fee. HOOVER is suppose to go back to work Monday. DAVIS says he has another man (unidentified) who has a camera with a tele-photo lense, who will be assigned to take photographs of various places of interest to DAVIS.

DAVIS claims that the Nazis want to start conducting raids on local Jewish synagogues and want to start looking up information and planning tactics to taken against the JDL and the ADL.

Date prepared

1/24/72

Date received

9/9/71

Received from (name or symbol number)

SD 1155-E

Received by

SA Steven L. Christensen

Method of delivery (check appropriate blocks)

in person by telephone by mail orally recording device written by Informant

If orally furnished and reduced to writing by Agent:

Date

Date of Report

9/9/71

Dictated _____ to _____

Date(s) of activity

Transcribed _____

Authenticated by Informant _____

Current

Brief description of activity or material

Info re activities of Godfrey, Bill Clay, Davis, Hoover, McDade
NSWAP

File where original is located if not attached

170-286

* INDIVIDUALS DESIGNATED BY AN ASTERISK (*) ONLY ATTENDED A MEETING AND DID NOT ACTIVELY PARTICIPATE. VIOLENCE OR REVOLUTIONARY ACTIVITIES WERE NOT DISCUSSED.

Information recorded on a card index by _____ on date _____

Remarks:

170-286 A-118
157-28 (NSWAP)
100-14819 (Godfrey)
100-14297 (Davis)
100-15356 (Hoover)
~~100-2305~~ (Clay)
100-14610 (McDade)
100-16200 (Celrep)
2 - Los Angeles
2 - Sacramento

Index: National Justice Foundation to 100-14819.
~~National Justice Foundation to 100-14819.~~
~~100-14819 to 100-14819.~~

Block Stamp

170-286-A-118

SEARCHED	INDEXED
SERIALIZED	FILED
JAN 21 1972	
FBI - SAN DIEGO	

[Handwritten signatures and initials over stamp]

JEROME

September 9, 1971

In talking with BARRY GODFREY, I learned of the formation of a new organization known as the National Justice Foundation. This organization is supposed to be a group of lawyers from the Los Angeles and Sacramento areas whose purpose will be to counteract the work of the ACLU.

I also learned that the groups which are protesting the sailing of the USS Constellation are going to set up polling booths outside various city polling places and at other locations in an attempt to get people to vote on whether the USS Constellation should sail.

I also was told that the Bishop faction of the Nazi Party is now known as the National Socialist American Workers Party, and is putting out a new newspaper named "Attack". Apparently, this newspaper is being published and printed at Los Angeles, California.

GODFREY also told me he was recently interviewed by a San Diego County Deputy Sheriff named D. Q. MARTIN, regarding GODFREY's involvement in Minuteman and other right wing activities. MARTIN was apparently under the impression that GODFREY was one of the leaders of these activities and would be able to furnish much information as to names, addresses, and activities of other people who are involved. GODFREY denied any knowledge whatsoever of such activities which caused MARTIN to become extremely aggravated and to make some veiled threats against GODFREY. However, he eventually gave up and left. Afterward, GODFREY discussed this matter with SAM DAVIS, MICK HOOVER, and a few other people. It was their feeling that MARTIN's visit to GODFREY was probably caused by BILL CLAY. CLAY has suddenly been around contacting people, asking questions and trying to find out what is going on. CLAY even made a personal appearance at the Gunsmoke Ranch and, while there, apparently caused some friction as HOOVER has now been asked to leave the ranch. The questions in

these people's minds now is whether CLAY has turned informer for the Sheriff's Office and was the source of information for MARTIN regarding GODFREY's activities.

It seems that DAVIS, HOOVER, and STAN MC DADE are now not as interested in the Nazis as they formerly were. However, they will continue to cooperate with that group. DAVIS appears to be very enthusiastic about the coming Republican National Convention. He thinks that this will be his big chance to do something that will be remembered in the world. He said he is working on plans to organize a series of meetings of eight to twelve people to make plans for and obtain pledges of financial support for right wing harassment activities during the convention.

General

Date prepared

1/24/72

Date received

9/13/71

Received from (name or symbol number)

Wife informant
SD 1155-E

Received by

SA Steven L. Christensen

Method of delivery (check appropriate blocks)

in person by telephone by mail orally recording device written by Informant

If orally furnished and reduced to writing by Agent:

Date

Date of Report

9/13/71

Dictated _____ to _____

Date(s) of activity

Current

Transcribed _____

Authenticated by Informant _____

Brief description of activity or material

Right Wing activities in San Diego + Los Angeles

File where original is located if not attached

170-286

* INDIVIDUALS DESIGNATED BY AN ASTERISK (*) ONLY ATTENDED A MEETING AND DID NOT ACTIVELY PARTICIPATE. VIOLENCE OR REVOLUTIONARY ACTIVITIES WERE NOT DISCUSSED.

Information recorded on a card index by _____ on date _____

Remarks:

- ~~170-286A-119~~
- 157-28 (NSWPP)
- 100-14297 (Davis)
- 157-201 (Smith)
- 100-14303 (Walton)
- 100-14610 (McDade)
- 157-1813 (Haughton)
- 157-2305 (Clay)
- 2-157- (Whit Guire) (open news)
- 2-157- (Edith Guire) (open news)
- 100-14294 (Clark)
- 157-1614 (Haughton)
- 157-2388 (Winchester)
- 3 - Los Angeles
 - (1 - LA 157- NSWPP)
 - (1 - LA 157-5565 Scott Winchester)
 - (1 - LA 157- Joseph Tomasi)

Index: ~~Scott Winchester~~ to 157-28. Joseph Tomasi to 157-28. Ed Boyd to 157-1614.

44-12461-630

Block Stamp

170-286A-169

SEARCHED	INDEXED
SERIALIZED	FILED
JAN 24 1972	
FBI - SAN DIEGO	

JEROME

September 13, 1971

I was in contact with SAM DAVIS this morning. He told me that he has joined the Nazi Party and that today he rented Post Office Box 5791, San Diego, California, for the Nazis. He said he has been assigned to act as a Storm Trooper group leader in the San Diego area and has begun actively organizing for the Nazis.

He explained that he went to see SCOTT WINCHESTER at Torrance, California, yesterday. He said he met WINCHESTER at a place named The Bavarian Alpine Village where WINCHESTER's group has relocated. He said that the activities of WINCHESTER's group are very open and that there was a lot of Nazi literature and posters in plain view. He said he observed many people giving the Nazi salute and handing SCOTT WINCHESTER money.

DAVIS said there were several thousand people present at The Bavarian Alpine Village with hundreds of them dancing around outside the Nazi Party headquarters. He said the crowd included many Lithuanians, Estonians, and Arabs, as well as Germans, most of whom appears to be pro-Nazi. DAVIS said one Arab was introduced to him as the leader of the Al Satrah Group at Los Angeles. He said that another person who was introduced to him claimed to have worked for the HITLER Youth SS and was wearing a gold SS ring. DAVIS himself is now wearing a silver SS ring.

I also learned that GERALD L. SMITH and one of his Lieutenants went into the "Peace House" at 2143 Market Street, early last Friday afternoon to get some of their literature. They were dressed in full Nazi uniform and when they went into the house, they found a meeting of about fifty persons in progress.

Their appearance in Nazi uniforms caused a great deal of consternation among those people at the meeting.

Also, it has come to my attention that SAM and his associates have been asked to set up a printing press for the Nazis in Vic Walton's guest house and have taken this request under favorable consideration.

GERALD L. SMITH local Nazi Party Group, the National Socialist White People's Party, is affiliated with the same group at Los Angeles which is run by JOE TOMASSI. DAVIS, however, favors the Nazi Party Group run by SCOTT WINCHESTER at Los Angeles, and is working with STAN MC DADE to engineer a switch of SMITH's group from the TOMASSI group to the WINCHESTER group. DAVIS said that MC DADE and SMITH are on very friendly terms.

The Right Wing Activists in the San Diego area have three printing presses. One, which belongs to BETTIE HAUGHTON, is located at the residence of WALT and EDITH GEYER on Massachusetts Avenue in La Mesa. Another, which is owned by BILL CLAY, is located at the residence of HOWARD CLARK at Ramona, California, and the third, which belongs to ED BOYD, TROY HAUGHTON's step-father, is in the possession of STAN MC DADE.

Jerome

Date prepared

1/24/71

Date received

9/20/71

Received from (name or symbol number)

SD 155-E

Received by

SA Steven L. Christensen

Method of delivery (check appropriate blocks)

in person by telephone by mail orally recording device written by Informant

If orally furnished and reduced to writing by Agent:

Date

Dictated _____ to _____

Transcribed _____

Authenticated by Informant _____

Date of Report

9/20/71

Date(s) of activity

Current

Brief description of activity or material

Info re Right Wing activities in San Diego area.

File where original is located if not attached

170-286

* INDIVIDUALS DESIGNATED BY AN ASTERISK (*) ONLY ATTENDED A MEETING AND DID NOT ACTIVELY PARTICIPATE. VIOLENCE OR REVOLUTIONARY ACTIVITIES WERE NOT DISCUSSED.

Information recorded on a card index by _____ on date _____

Remarks:

- 170-286A-170
- 100-14297 (Dasis)
- 100-14294 (Clark)
- 100-15336 (Hoover)
- 100-15355 (Busch)
- 100-14610 (Mc Rade)

170-286A-170
Block Stamp

SEARCHED _____ INDEXED _____
SERIALIZED _____ FILED _____
JAN 25 1971
FBI - SAN DIEGO
[Signature]

JEROME

September 20, 1971

I was in contact with SAM DAVIS last night. I learned from him that HOWARD CLARK is driving a new light colored Pickup Truck with a camper shell on it. Furthermore, GEORGE HOOVER is now living with JERRY BUSCH. BUSCH lives with his mother in an apartment house at the corner of McLintock and El Cajon Boulevard. This apartment house is the first one on the right as you go north on McLintock. BUSCH's apartment is the upper rear.

I also learned that STAN MC DADE has leased a cabin somewhere on Mt. Palomar to be used as a hideout if necessary.

Jerome

Date prepared

1/24/72

Date received

9/16/71

Received from (name or symbol number)

W. W. W. W.
SD 1155-E

Received by

SA Steven H. Christensen

Method of delivery (check appropriate blocks)

in person by telephone by mail orally recording device written by Informant

If orally furnished and reduced to writing by Agent:
Date

Date of Report

9/16/71

Date(s) of activity

Current

File where original is located if not attached

170-286

Dictated _____ to _____

Transcribed _____

Authenticated by Informant _____

Brief description of activity or material

Info re Right Wing activities
in San Diego area

* INDIVIDUALS DESIGNATED BY AN ASTERISK (*) ONLY ATTENDED A MEETING AND DID NOT ACTIVELY PARTICIPATE. VIOLENCE OR REVOLUTIONARY ACTIVITIES WERE NOT DISCUSSED.

Information recorded on a card index by _____ on date _____

Remarks:

170-286A-121
100-14297 (Davis)
100-14819 (Godfrey)
157-1820 (Yakofee)
157-1813 (Haughton)
157-2815 (SAO)

Index O. R. Alexander
to 157-2815.

Block Stamp

170-286A-121
SEARCHED SERIALIZED
SERIALIZED FILED
JAN 24 1972
FBI - SAN DIEGO
W

JEROME
September 16, 1971

I was in contact with SAM DAVIS yesterday and he was explaining to me some of the plans he has for the new organization he is trying to establish. He said he wants to try and have the application forms and some of the training materials printed this weekend. He also said he will get a new San Diego post office box tomorrow. There will be two membership lists maintained which will be recorded on microfilm so they will be easy to hide. One of these lists will be kept by DAVIS and the other will be held by BARRY GODFREY. There will be monthly literature mailouts with DAVIS and GODFREY responsible for the mailouts on alternate months. However, the mailouts will be made from GODFREY's house. The supplies for the mailouts and other materials are to be kept in FRANK YACOPEC's attic.

SAM said that BETTIE HAUGHTON has a large quantity of training literature and other supplies in her possession which he will attempt to obtain from her. He said that ALEX (LNU) of Alex Rapid Print has agreed to donate a part of the printing costs for this literature.

In addition, DAVIS said that when the organization gets going specialized training tapes will be made up for advanced trainees. He said he thinks that when the organization is in full swing the literature mailouts and training aids will cost at least \$100 a month.

Jerome

Date prepared

1/24/72

Date received

9/28/71

Received from (name or symbol number)

Informant
SD 1155-E

Received by

SA Steven H. Christensen

Method of delivery (check appropriate blocks)

in person by telephone by mail orally recording device written by Informant

If orally furnished and reduced to writing by Agent:

Date

Dictated _____ to _____

Transcribed _____

Authenticated by Informant _____

Date of Report

9/28/71

Date(s) of activity

Current

Brief description of activity or material

Info re Right Wing activities
in San Diego Area

File where original is located if not attached

170-286

* INDIVIDUALS DESIGNATED BY AN ASTERISK (*) ONLY ATTENDED A MEETING AND DID NOT ACTIVELY PARTICIPATE. VIOLENCE OR REVOLUTIONARY ACTIVITIES WERE NOT DISCUSSED.

Information recorded on a card index by _____ on date _____

Remarks:

170-286A-122
100-14297 (Dane)
2-159- (Roger Drapeau) (open news)
100-14294 (Clark)

170-286A-122
Block Stamp

SEARCHED INDEXED
SERIALIZED FILED
JAN 24 1972
FBI - SAN DIEGO
Christensen

JEROME
September 28, 1971

Early this morning, I was contacted by SAM DAVIS who was looking for someone to help him with a project. I told him I had other commitments for the day and he said he would try to find someone else to help him. Later on, I talked to him again and he told me he had wanted someone to help him to move several hundred pounds of explosives from the residence of one ROGER (LNU) at 2003 Dartmoor in Spring Valley, California. DAVIS claimed that these explosives included TNT, C-4 Plastic Explosives, and rifle grenades. DAVIS would not even hint as to where these explosives had been moved but did make a statement to the effect "some day we'll have to move the master cache". I got the impression that HOWARD CLARK may have been involved in this project. I understand that the individual named ROGER lived with a Mexican woman and several children at that address. I have never heard of this ROGER before but will try to find out more.

Jerome

Date prepared

1/24/72

Date received

10/8/71

Received from (name and symbol number)

Informant
SD 155-E

Received by

SA Stewart, Chris Loren

Method of delivery (check appropriate blocks)

in person by telephone by mail orally recording device written by Informant

If orally furnished and reduced to writing by Agent:

Date

Dictated _____ to _____

Transcribed _____

Authenticated by Informant _____

Date of Report

10/8/71

Date(s) of activity

Current

Brief description of activity or material

Info re SAO & other Right Wing activities in San Diego area.

File where original is located if not attached

190-286

* INDIVIDUALS DESIGNATED BY AN ASTERISK (*) ONLY ATTENDED A MEETING AND DID NOT ACTIVELY PARTICIPATE. VIOLENCE OR REVOLUTIONARY ACTIVITIES WERE NOT DISCUSSED.

Information recorded on a card index by _____ on date _____

Remarks:

170-286A-123

100-16342 (Rick Buras)

100-14159 (Dr. George Abbott) ~~Under 100 Street Council~~ ~~re: file~~

100-15463 (Herbert Aaron Gindler)

100-14610 (McDade)

157-2815 (SAO)

100-15356 (Hoover)

100-15355 (Busch)

100-14297 (Davis)

100-14819 (Godfrey)

170-286A-123
Block Stamp

SEARCHED INDEXED
SERIALIZED FILED
JAN 24 1972
FBI - SAN DIEGO
[Signature]

JEROME
October 8, 1971

It has come to my attention that the individual I told you about previously named RICK BURNS, who is a fireman at San Diego Fire Department Station Number 13 in La Jolla, continues to make extremely sympathetic statements about communism in Russia and China. In addition, while at work, he always has a copy of the "Door" or the "Street Journal" with him. I was also told that he was observed writing the name of Dr. GEORGE ABBOTT and telephone number 488-4421 and the name HERBERT GINDLER on the wall at the fire station near the telephone.

I was in contact with STAN MC DADE earlier today. He said he has had one thousand copies of the new membership application form for the Secret Army Organization printed up as well as a large number of copies of letterhead stationery for the group. The membership initiation fees to join the organization will be \$5 and there will be a \$3 per month dues assessed for each member. MC DADE said he believes he will join the organization.

I learned that GEORGE HOOVER, who is out of work, is now receiving unemployment payments. He also allegedly been on some of the local reservations attempting to recruit Indians to help work in opposition to the Leftists.

I also found out that SAM DAVIS, HOOVER and JERRY BUSCH have been talking about committing robberies of houses of prostitution and similar establishments where there would be little likelihood of the theft being reported. The purpose of these robberies, of course, is to obtain money to finance right wing activities.

Lestly, I learned that BARRY GODFREY is supposed to see SAM DAVIS this afternoon and furnish him with 3,500 rounds of .45 and .223 caliber ammunition.

J. R. [unclear]

Date prepared

1/24/72

Date received

10/20/71

Received from (name or symbol number)

Informant
50155-E

Received by

SA Steven L. Christensen

Method of delivery (check appropriate blocks)

in person by telephone by mail orally recording device written by Informant

If orally furnished and reduced to writing by Agent:

Date

Dictated _____ to _____

Transcribed _____

Authenticated by Informant _____

Date of Report

10/20/71

Date(s) of activity

Current

Brief description of activity or material

Info re Right Wing activities at San Diego; Yuma, Arizona Gun Shows; SAO

File where original is located if not attached

170-286

INDIVIDUALS DESIGNATED BY AN ASTERISK () ONLY ATTENDED A MEETING AND DID NOT ACTIVELY PARTICIPATE. VIOLENCE OR REVOLUTIONARY ACTIVITIES WERE NOT DISCUSSED.

Information recorded on a card index by _____ on date _____

157-2877-1

Remarks:

- 70-286A-124
- 57-2815 (SAO)
- 57-1813 (Haughton)
- 57- (Walter A. Gaire)
- 00-14297 (Davis)
- 00-14819 (Godfrey)
- 57- (Robert S. Mayer)
- 00-14610 (Mc Dade)
- 00-14301 (Ruplinger)
- 07-1816 (Poto)
- 00-15356 (Hoover)
- 00-15355 (Busch)
- 57-28 (NSWPP)
- 57-201 (Smith)
- 57-2177 (Forrest)

Index: Bill Guette, Terry Brown, Charles Kinell, (FNU) McGill, Ralph Humphreys, Tom Webster, Lannie Reed, Dick Geise, Granny Martin, Cy Anderson to 157-2815.

Block Stamp

170-286A-124

SEARCHED INDEXED
 SERIALIZED FILED
 JAN 25 1972
 FBI - SAN DIEGO
 [Signature]

~~157-2832 (Carey)~~

100-14807 (Geyer)

157-2832 (Carey)

157-1820 (Yakobec)

2 - Las Vegas

2 - Los Angeles

2 - Seattle

2 - Phoenix

REPORT BY JEROME

October 20, 1971

Attached is a copy of the new letterhead stationery of the Secret Army Organization (SAO). This letterhead was printed approximately two weeks ago along with a large number of sheets which are information bulletins and a so-called history of the organization. Some stickers advertising for support of the SAO were printed about one week later. All of the printing has been done on BETTY HAUGHTON's offset press either by her or by WALT GUYER.

In line with the decision to go ahead and set up the SAO organization, SAM DAVIS and BARRY GODFREY have been out contacting people in an attempt to get new recruits. So far, FRANK YACOPEC, PAUL RUPLINGER, ROBERT MAYER, STAN MC DADE, and JAMES EVAN POTO have been approached and appear to be reasonably disposed to joining the new organization. Two other individuals, GEORGE HOOVER and JERRY LEE BUSCH, apparently are not to know about the organization for the time being. However, they have been asked to do some intelligence-type investigations and reports on some random Left Wing activities which are involved in the project to attempt to keep the USS Constellation from sailing on 11/1/71. So far, they have turned in one report, which I gather was beautifully done, typed and dealt with the layout of the building involved, its occupants, the police coverage, and other areas of interest. HOOVER and BUSCH are supposed to be busy at the present time on a similar report on another groups.

In addition to the individuals named above, there are probably several other people in the San Diego area who would be supporters of, or sympathetic, to the SAO who have not yet been officially contacted.

As previously reported, SAM DAVIS and GEORGE HOOVER and STAN MC DADE were very much interested in joining the local Nazi group, the National Socialist White Peoples Party (NSWPP). However, they recently discovered that the official Nazi Party policy is very much anti-American Indian and they are now very disenchanted with the Nazis as DAVIS is one-quarter Indian and HOOVER is one-half Indian. In addition, this policy has cost GERALD L. SMITH one of his best

lieutenants (name not known). This person was living with a girl who is part Indian and when SMITH ordered him to stop seeing her, he left the organization instead. It is possible that he may join the SAO.

This interesting turn of events may have been one of the important factors which caused DAVIS to try and get the SAO off the ground.

Many of the SAO organizational histories and news bulletin sheets have been sent out and are being sent out to other people who have been known in the past to be Right Wing sympathizers.

Those individuals from the San Diego area known to be Right Wing sympathizers who attended the recent gun show at Yuma, Arizona, included the following:

STAN MC DADE

SAM DAVIS

BARRY GODFREY

BILL GUIETTE

TERRY BROWN

CHARLES KINNEL

JERRY GUYER

(FNU) MC GILL

TOM FORREST

DON CAREY

RALPH HUMPHREYS

WAYNE HUMPHREYS (son of RALPH)

TOM WEBSTER

LANNIE REED

DICK GEISE

GRANNY MARTIN

and others.

CY ANDERSON, from someplace ^{Everett} in the Seattle, Washington, area, as well as ~~EDWARD~~ MOORE and his wife, who are identified as Miami leaders in the Phoenix, Arizona, area, were also in attendance.

In addition, the Angriff Press (DON SISCO's group) was well represented and had set up a table on which were being sold all kinds of manuals and literature on explosives and incendiaries. They were also selling blasting cap crimpers and American Nazi Party Christmas cards.

The people sponsoring the gun show expected only about 200 individuals to show up. However, there were 200 tables set up, on many of which two persons were displaying their merchandise, plus many spectators for a total of at least 500 individuals at the show. Included among these were many Yuma County Sheriffs and city police officers who were taking an active part in the show. I believe some ATFD Agents showed up at the show but were afraid to make any arrests or take any other action due to the large numbers of people at the show and the obvious lack of support they were getting from the local law enforcement officers. I honestly believe there would have been a big shootout if the ATFD Agents had attempted to take any kind of action such as make an arrest or seize some piece of merchandise. Most of the people at the show seemed to be in a very bad mood toward the ATFD.

One of the hottest items at the show was .50 caliber machine gun ammunition. BILL GUIETTE took a large quantity of this ammunition to sell and got rid of all of it. There was a Pro-nationalist Chinese individual there, who was well known to CY ANDERSON, who was buying all the .50 caliber ammunition and magazines and parts he could get. I was told that he is supposed to be filthy rich and to have a stupendous arsenal located on his ranch somewhere in Southern Arizona.

Following the gun show, a meeting involving ^{Everett} ~~EDWARD~~ MOORE, CY ANDERSON, SAM DAVIS, MC DADE and GODFREY was held to discuss the SAO. The news bulletin and history sheets of

the SAO were passed around and MOORE and ANDERSON agreed that their respective groups would join in with the SAO as they felt that some cohesion among Right Wing groups has become necessary due to the power vacuum left by the Minuteman organization.

After the show, SAM DAVIS drove to Las Vegas, Nevada to contact some people there, among them a person named JACK DOYLE who is supposed to have Mafia connections, to determine if they were interested in the SAO and, if so, what support or assistance they can give.

En route to the gun show, CY ANDERSON broke down somewhere in Nevada and he had been forced to hire someone to bring him on to the gun show. After the show, he rode back to the location of his automobile with SAM DAVIS.

ANDERSON brought with him to the gun show a number of U.S. Navy survival kits, some Army sleeping bags, an AR 180 rifle in a .223 caliber and some miscellaneous gun parts for the KARNES of AR sales at Los Angeles, California, who were also at the show. ANDERSON appeared to be good friends of the KARNES.

While at the gun show, ANDERSON was overheard to state that his group had recently lost 5,000 feet of primacord and 10 machine guns in a raid by the ATFD on a friend's house. ANDERSON said he was not too concerned about the machine guns but he really hated to lose all of that Primacord. It was learned that ANDERSON supposedly has a blaster's permit with which he can obtain most of the commercially available explosives that he wants. ANDERSON said he was going to stay in the Southwest party of the country for about two weeks to make contact with people he knows. He said the last week of this two-week period would be spent in San Diego helping to get the SAO started.

In addition, he indicated he probably would return to the San Diego area in about two months at which time he would bring more weapons to sell.

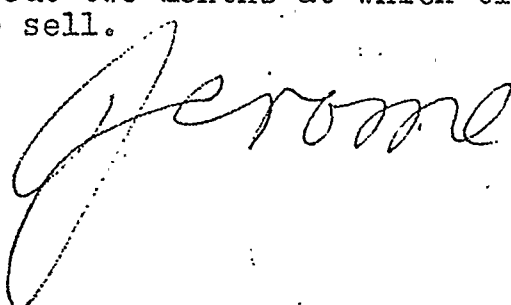
A large, stylized handwritten signature in cursive script, appearing to read "Jerome". The signature is written in dark ink and is positioned in the lower right quadrant of the page, below the main body of text.

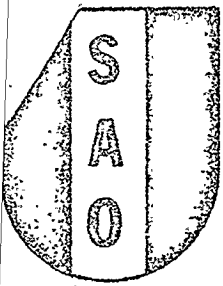

SECRET ARMY ORGANIZATION

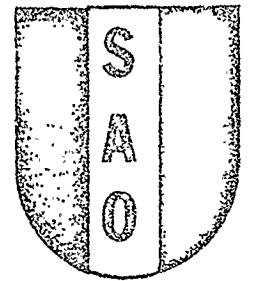

Date received

10/26/71

Received from (name or symbol number)

~~EDUS-E~~
informant

Received by

SA Steven L. Christensen

Date prepared

1/24/72

Method of delivery (check appropriate blocks)

in person by telephone by mail orally recording device written by Informant

If orally furnished and reduced to writing by Agent:

Date

Dictated _____ to _____

Transcribed _____

Authenticated by Informant _____

Date of Report

10/26/71

Date(s) of activity

Current

Brief description of activity or material

Info re Right Wing Activities in San Diego area.

File where original is located if not attached

170-286

* INDIVIDUALS DESIGNATED BY AN ASTERISK (*) ONLY ATTENDED A MEETING AND DID NOT ACTIVELY PARTICIPATE. VIOLENCE OR REVOLUTIONARY ACTIVITIES WERE NOT DISCUSSED.

Information recorded on a card index by _____ on date _____

Remarks:

170-286A-125
100-14297 (Davis)
157-2815 (SNO)
157-28 (NSWPP)
100-15356 (Hoover)

Index: by Anderson to 157-2815.

3-Seattle

Block Stamp

170-286A-125

SEARCHED INDEXED
SERIALIZED FILED

JAN 21 1972
FBI - SAN DIEGO

[Handwritten signature]

JEROME
October 26, 1971

SAM DAVIS called last Saturday night to tell me he had finally returned to San Diego. He said he got more involved at Las Vegas in organizing and contacting people than he had expected to. It looks as though some of the people he met at Las Vegas will be joining the SAO group. This morning, we are supposed to go to all of the post office boxes and see if there has been any response to the mailing out of the first literature on the SAO. We also are going to order insignia patches to be sewn on the berets that SAO members will wear. These patches will be obtained through CY ANDERSON at Seattle, Washington. SAM also wants to start work on organizing some urban Guerilla warfare squads. He said he wants to form these squads with six men to a squad and two cars to a squad.

I also learned from him that there will be a White Power rally in Balboa Park on October 30, 1971. This rally will be sponsored by the local Nazi Group.

I am also supposed to go with GEORGE HOOVER this afternoon to help him begin recruiting his six man squad.

Jerome

Date prepared

1/24/72

Date received

10/27/71

Received from (name or symbol number)

informant
SD 1155-E

Received by

SA Steven Christensen

Method of delivery (check appropriate blocks)

in person by telephone by mail orally recording device written by Informant

If orally furnished and reduced to writing by Agent:

Date

Dictated _____ to _____

Transcribed _____

Authenticated by Informant _____

Date of Report

10/27/71

Date(s) of activity

Current

Brief description of activity or material

Info re Right Wing activities
in San Diego area

File where original is located if not attached

170-286

* INDIVIDUALS DESIGNATED BY AN ASTERISK (*) ONLY ATTENDED A MEETING AND DID NOT ACTIVELY PARTICIPATE. VIOLENCE OR REVOLUTIONARY ACTIVITIES WERE NOT DISCUSSED.

Information recorded on a card index by _____ on date _____

Remarks:

- 170-286A-126
- 100-15386 (Hoover)
- 100-15355 (Busch)
- 100-14610 (McDade)
- 100-14297 (Davis)
- 100-14819 (Godfrey)
- 157-2815 (SAO)
- 157-2177 (Forrest)
- 157-2921 (Zarick)
- 157-1816 (Poto)

Index: Cy Anderson,
Jack Doyle, ~~Frank~~
~~phone~~ to 157-2815
157-2831 - Exec (T) H. 2/7

- 2 - Las Vegas
- 2 - Phoenix
- 2 - Seattle
- 2 - Los Angeles

Block Stamp

170-286A-126

SEARCHED INDEXED
SERIALIZED FILED

JAN 25 1972
FBI - SAN DIEGO

Christensen

JEROME
October 27, 1971

I was in contact with GEORGE HOOVER yesterday afternoon. He said that the Nazi sponsored White Power rally will be held in Balboa Park at the House of Hospitality on October 30, 1971, a Saturday, at noon. He said he and some of his associates have been thinking of directing some incident against the United Nations Building in Balboa Park in retaliation for recent actions taken by the United Nations with regard to Nationalist China. He said some of the things that have been considered are picketing the United Nations Building in the park, entering the building and taking down the United Nations flag and burning it. People who might be involved in this incident if it takes place would be HOOVER, JERRY BUSCH, and some of the Nazi Party members. They may attempt to draw supporters for this incident from the White Power rally which will take place the previous day. HOOVER was also talking about trying to get some members of the Chinese-American Association down to help.

HOOVER and STAN MC DADE are presently on a religious organization kick and are associated with the Missionary Church of Jesus Christ run by Reverend GALE at Los Angeles. They have acquired some fancy blue uniforms to go along with their involvement in this group. I understand that SAM DAVIS and BARRY GODFREY have decided to stay away from this group.

The individuals with whom SAM DAVIS was in contact at Las Vegas are JACK DOYLE, telephone number 642-4467, and ED (LNU), post office box 2191, Las Vegas, telephone number 384-2046.

CY ANDERSON, who has been in Texas since he went to Las Vegas with SAM DAVIS from the Yuma gun show, is supposed to be in town this Friday afternoon. I have learned that he is an old friend of RON ZARICK and TOM FORREST. I also learned that SAM DAVIS and BARRY GODFREY want to go to the

Phoenix gun show in December for the purpose of making contact with EV MOORE.

It has also come to my attention that JIM POTO has lost a lot of weight and also has joined the SAO.

Jerome

Date prepared

1/25/72

Date received

10/28/71

Received from (name or symbol number)

informant
SD 1155-E

Received by

SA Steven L. Christensen

Method of delivery (check appropriate blocks)

in person by telephone by mail orally recording device written by Informant

If orally furnished and reduced to writing by Agent:

Date

Date of Report

10/28/71

Dictated _____ to _____

Date(s) of activity

Transcribed _____

Authenticated by Informant _____

Current

Brief description of activity or material

Info re Right Wing activities
in San Diego area

File where original is located if not attached

SD 170-286

* INDIVIDUALS DESIGNATED BY AN ASTERISK (*) ONLY ATTENDED A MEETING AND DID NOT ACTIVELY PARTICIPATE. VIOLENCE OR REVOLUTIONARY ACTIVITIES WERE NOT DISCUSSED.

Information recorded on a card index by _____ on date _____

Remarks:

- 170-286A-127
- 100-15356 (Hoover)
- 100-15355 (Busch)
- 157-2921 (Zarick)
- 100-12464 (Melvin Crain)
- 157-549⁵⁴⁴ (Nower)
- 100-14297 (Davis)
- 157-2815 (SAO)
- 157-2177 (Forest)

Index: Cy Anderson to 157-2815

2-Seattle

Block Stamp

170-286A-127

SEARCHED INDEXED

SERIALIZED FILED

JAN 26 1972

FBI - SAN DIEGO

Christensen

JEROME
October 28, 1971

I was in contact with RON ZARICK earlier today. He claimed that he had some explosives he wanted to sell and asked if I was interested.

I also understand that there were some spies, probably GEORGE HOOVER and JERRY BUSCH, watching ROD BURTON's house at 1511 29th Street, yesterday. Apparently, some kind of meeting was taking place there and one man had been stationed out front as a watchman. Automobiles known to belong to MELVIN CRAIN and LEON NOWER were observed parked at the residence.

A person I have mentioned before, CY ANDERSON, will be at SAM DAVIS' house tomorrow. It is my understanding that ANDERSON was originally introduced to DAVIS by TROY HAUGHTON. Furthermore, I was told that SAM DAVIS met TOM FORREST through CY ANDERSON. It looks as though ANDERSON may be one of the biggest right wing operators and dealers in firearms in the west. The trip which ANDERSON made to Texas actually took him to El Paso. He apparently made contact there with several individuals whose identities are known to DAVIS but who would not divulge them to me.

The following is a rough physical description of CY ANDERSON:

Race	White
Sex	Male
Height	6'2" - 6'4"
Weight	approximately 275 pounds
Build	large
Age	30 to 35 years
Eyes	Blue
Hair	Blond and worn in a butch hair cut
Complexion	Pale
Marital status	Married (his wife was with him at the Yuma gun show)
Occupation	Probably a mechanic

Jerome

Date prepared

1/25/72

Date received

11/4/71

Received from (name or symbol number)

Informant
SD 1155-E

Received by

SA Steven L. Christensen

Method of delivery (check appropriate blocks)

in person by telephone by mail orally recording device written by Informant

If orally furnished and reduced to writing by Agent:

Date

Dictated _____ to _____

Transcribed _____

Authenticated by Informant _____

Date of Report

11/4/71

Date(s) of activity

Current

Brief description of activity or material

Right Wing activities in San Diego area.

File where original is located if not attached

SD 170-286

* INDIVIDUALS DESIGNATED BY AN ASTERISK (*) ONLY ATTENDED A MEETING AND DID NOT ACTIVELY PARTICIPATE. VIOLENCE OR REVOLUTIONARY ACTIVITIES WERE NOT DISCUSSED.

Information recorded on a card index by _____ on date _____

Remarks:

170-286A-128

100-15356 (Hoover)

100-15355 (Busch)

159-14610 (Stanley Don McDade)

157-28 (NSWPP)

2 - Los Angeles

170-286A-125
Block Stamp

SEARCHED	INDEXED
SERIALIZED	FILED
JAN 16 1972	
FBI - SAN DIEGO	

Christensen

JEROME
November 4, 1971

I have learned from GEORGE HOOVER, STAN MC DADE, and JERRY BUSCH attended a meeting of GERALD L. SMITH's Nazi Group last night. As I mentioned before, HOOVER has become involved in the activities of a semi-religious group named the Missionary Church of Jesus Christ. This group is run by a Reverend GALE at Los Angeles, California. GALE claims to be a retired Colonel and a former aid to General MC ARTHUR. GALE comes from Los Angeles to San Diego to speak approximately once a month. He is very anti-semitic and has Nazi tendencies although I doubt he belongs to any Nazi organization. HOOVER is in the process of trying to get himself ordained as a minister of this church. He has made himself up a fancy blue uniform which he wore to the Nazi Party meeting and, apparently, so impressed the other members of the group at the meeting, that many of them wanted to join HOOVER's group, as he had a better uniform than the Nazi uniform. This has apparently caused SMITH a great deal of consternation and he is now busily trying to re-organize his group.

I went by the "Peace House" last night and took a peek through the windows. No one seemed to be home and I observed the house to be stacked full of literature and other printed materials.

Jerome

UNITED STATES GOVERNMENT

Memorandum

TO : SAC, SAN DIEGO (157-new)

FROM : SA STEVEN L. CHRISTENSEN

SUBJECT: LOUIS RAYMOND CONDE
EM - WIG

DATE: 1/31/72

On 1/28/72, ^{informant} SD 1155-E advised he and JERRY LYNN DAVIS had gone that morning to the Subject's residence at 4980 Academy in the ~~San Diego~~ area of San Diego. Purpose of the visit was to solicit financial support for the SAO from CONDE. CONDE agreed to furnish such, along with other assistance and contacts, in return for SAO support in his campaign for the seat on the County Board of Supervisors which is now held by WALTER SHIDFILL (PH). One form of support SAO will give is to print campaign literature for CONDE on its printing presses. Source said CONDE has the support of both the La Jolla Town Council and the Clairmont Town Council in his campaign, and is well thought of in Republican Party circles for his campaign efforts in behalf of Governor RONALD REAGAN.

It is noted that when first contacted, source asked the writer if he was acquainted with a former FBI Agent named BOB SUNDQUIRK or something similar to that name. Writer asked source if SUNDQUIST was close enough and source replied that was the name he had in mind. He explained that in the conversation with CONDE, he mentioned he had been obtaining information from SUNDQUIST for the benefit of Right Wing activists. Source said CONDE then took two checks from his desk and showed them to source and DAVIS. Source observed the amount on one of the checks was \$200.00. CONDE indicated SUNDQUIST had become indebted to him at an undetermined time in the past for a considerable sum of money and had attempted to pay him off with worthless checks. CONDE said he had used the threat of exposure or prosecution as a lever over SUNDQUIST to force him to furnish information.

Source advised he was not aware of the total amount of money owed CONDE by SUNDQUIST, the period of time involved, or the nature of the relationship between the two. He said he was impressed that CONDE had gained this advantage

- 2 - 157-new (LOUIS RAYMOND CONDE)
 - 1 - 157- (JERRY LYNN DAVIS)
 - 1 - 170-286A
- SLC/slc
(11)

170-286A-125

SEARCHED	INDEXED
SERIALIZED	FILED
FEB 1 1972	
FBI - San Diego	

an

Buy U.S. Savings Bonds Regularly on the Payroll Savings Plan

over SUNDQUIST prior to the time of the latter's retirement from the FBI. He did not know the nature of the information furnished, if any, to CONDE.

Source said CONDE then told them that SUNDQUIST is presently working for him, apparently doing some type of boat repair work. It was source's understanding that SUNDQUIST is doing some work on CONDE's personal boat. He said he does not know exactly where SUNDQUIST works or for how long he has been so employed.

Source stated he expects he and DAVIS to maintain close contact with Subject for the furtherance of the SAO. He said he would be alert for any additional information pertaining to this matter.

Date prepared

2/2/72

Date received

11/9/71

Received from (name or symbol number)

~~SD 155-E~~
informant

Received by

SA Steven L. Christensen

Method of delivery (check appropriate blocks)

in person by telephone by mail orally recording device written by Informant

If orally furnished and reduced to writing by Agent:

Date

Dictated _____ to _____

Transcribed _____

Authenticated by Informant 2/2/72

Date of Report

11/9/71

Date(s) of activity

Current

File where original is located if not attached

Brief description of activity or material

Information re SAO, Stan McDade,
NSWPP, Frank Yacopec, Robert
Mayer, Cy Anderson, Sam Davis

* INDIVIDUALS DESIGNATED BY AN ASTERISK (*) ONLY ATTENDED A MEETING AND DID NOT ACTIVELY PARTICIPATE. VIOLENCE OR REVOLUTIONARY ACTIVITIES WERE NOT DISCUSSED.

Information recorded on a card index by _____ on date _____

Remarks:

- 157-2815 (SAO)
- 170-286A-131
- 157-2305 (Clay)
- 157-2393 (McDade)
- 157-2610 (Wakefield)
- 157-201 (Smith)
- 157-28 (NSWPP)
- 157-1820 (Yacopec)
- 157-293 (Mayer)
- 157-3001 (Davis)

Index: Charles Manteve & Cy Anderson to 157-2815.

170-286A-131

Block Stamp

- 2 - Phoenix
 - 1- 157- (SAO)
 - 1- 157- (Charles Manteve)
- 1 - Seattle
 - 1- 157- (Cy Anderson)

SEARCHED INDEXED
SERIALIZED FILED
FEB 11 1972
FBI - PHOENIX
Christensen jwl

JEROME
November 9, 1971

The SAO has received its first response from the mailouts which were made in October. This came from an individual named CHARLES MANLEVE, 2938 North Seventeen Drive, Phoenix, Arizona, 85015. MANLEVE wrote his letter about two weeks ago expressing interest in the SAO and requesting more information about it.

Incidentally, we are about to lose BILL CLAY's old post office box at the Grossmont Post Office Station. The building where the station is located is to be torn down and the post office boxes are to be vacated by the 26th of this month. It would be helpful to obtain another post office box somewhere else in CLAY's name to facilitate the forwarding of mails.

In talking with STAN MC DADE, I have learned that MICKEY BURTON WAKEFIELD is no longer associated with SMITH's Nazi group. WAKEFIELD is either married to or has been living with a Mexican girl. The official Nazi Party policy is that people with American Indian blood, including Mexicans, are an inferior race and therefore Nazi Party members should have nothing to do with them. I understand that WAKEFIELD was ordered to dump the girl he was living with because of this policy, but refused to do so. Consequently, he either quit or was thrown out of the Nazi Party by SMITH.

MC DADE claimed that this same attitude on the part of the Nazis toward people with Indian blood as well as some other things which have happened has cost SMITH most of the membership of his group. MC DADE said that many of the Nazi Party members had Mexican wives or girlfriends and that SMITH has been telling the members to get rid of them which has created hard feelings.

I was also talking with FRANK YACOPEC and from him learned that his friend, ROBERT MAYER, is quite knowledgeable about radio communications. MAYER has been investigating the broadcasting set up of radio

station KSON. Apparently this station has its broadcast antenna located at some distance from the radio station itself. It has a repeater and amplifier arrangement at the antenna to pick up, amplify, and re-broadcast the relatively weak signal which comes from the radio station. Because of this set up, MAYER claims that with the proper ham radio equipment in a truck or car, most of which he already has, it would be possible for a right wing group to drive this vehicle in the vicinity of KSON's broadcast antenna, jam the signal from the base station, and put out its own fifteen minutes propaganda tape using KSON's broadcast antenna. YACOPEC and MAYER said they are going to work at setting up the necessary equipment to do this.

I have also been talking with SAM DAVIS. He told me that he and CY ANDERSON have made tentative plans for a trip which will start about December 1, 1971. If the trip is made, DAVIS and ANDERSON will meet in San Diego and from there go to Phoenix, Arizona, where they will leave SAM's car. They will then go on to Juarez and Mexico City, Mexico. After returning from Mexico, they will then travel to Denver, Colorado, and also to places in the state of Montana, with the fellow from Las Vegas, Nevada, named ED (LNU). The whole trip is to take two or three weeks and will be made for the purpose of making contacts in the various cities visited with people who are known to them as Right Wing Extremists or dealers in firearms, ammunition, and other equipment.

Gene

Date prepared

2/2/72

Date received

11/10/71

Received from (name or symbol number)

Informant
SP 1155-E

Received by

SA Steven L. Christensen

Method of delivery (check appropriate blocks)

in person by telephone by mail orally recording device written by Informant

If orally furnished and reduced to writing by Agent:

Date

Dictated _____ to _____

Transcribed _____

Authenticated by Informant 2/2/72

Date of Report

11/10/71

Date(s) of activity

Current

Brief description of activity or material

Info re Stan McDade

File where original is located if not attached

* INDIVIDUALS DESIGNATED BY AN ASTERISK (*) ONLY ATTENDED A MEETING AND DID NOT ACTIVELY PARTICIPATE. VIOLENCE OR REVOLUTIONARY ACTIVITIES WERE NOT DISCUSSED.

Information recorded on a card index by _____ on date _____

Remarks:

157-2933 (McDade)

170-286A-132

Block Stamp

170-286A-132

SEARCHED	INDEXED
SERIALIZED	FILED
FEB - 1 1972	
FBI - SAN DIEGO	
S. Christensen	

JEROME
November 10, 1971

STAN MC DADE is a very miserable and bitter individual. He has a strongly anti-semitic attitude, and blames the U.S. Government and Jewish business people for him being out of work and scraping bottom. He also claims that he has lost all of his friends because of his association with the Nazi Party.

MC DADE is a former merchant ship captain and still holds his masters papers. At one time he also had a large boat and a good boat yard too, but blames Jewish bankers for the loss of these and also for the fact that he cannot get a new business going. However, all he dreams about is going to sea again and getting away from the life on shore. He said he has been offered an eighteen-month contract to sail a ship but thinks he ought to stay home in order to be able to shoot Jews. He said he only stays with his wife because of the children they have but he does not care much for them either.

At one time, MC DADE supposedly was arrested and convicted on a charge of illegal possession of a machine gun. Allegedly, he received a presidential pardon in this connection. He said he thinks that the right wing cause is hopelessly lost and he is so miserable in his life that he actually hopes for a confrontation with the police or with the FBI so that he can end it all in a big shoot out.

Jerome

Date prepared

2/2/72

Date received

11/26/71

Received from (name or symbol number)

~~Informant~~
SD 115 E

Received by

SA Steven L. Christensen

Method of delivery (check appropriate blocks)

in person by telephone by mail orally recording device written by Informant

If orally furnished and reduced to writing by Agent:

Date

Dictated _____ to _____

Transcribed _____

Authenticated by Informant 2/2/72

Date of Report

11/22/71

Date(s) of activity

11/21/71

Brief description of activity or material

Info re Sam Davis, Barry Godfrey,
Roger Drapeau

File where original is located if not attached

* INDIVIDUALS DESIGNATED BY AN ASTERISK (*) ONLY ATTENDED A MEETING AND DID NOT ACTIVELY PARTICIPATE. VIOLENCE OR REVOLUTIONARY ACTIVITIES WERE NOT DISCUSSED.

Information recorded on a card index by _____ on date _____

Remarks:

- 157-3001 (Davis)
- 170-286A-133
- 100-14819 (Godfrey)
- 157-3000 (Drapeau)
- 157-2933 (McDade)
- 157-1614 (Haughton)
- 157-1813 (Haughton)

170-286A-133

Block Stamp

SEARCHED _____ INDEXED _____
 SERIALIZED _____ FILED _____
 FEB - 10/2
 FBI - SAN DIEGO
 [Signature]

JEROME
November 22, 1971

I was talking to SAM DAVIS and BARRY GODFREY at GODFREY's house last night. SAM was asking if we knew where he could find a two and one-half pound block of C-4 plastic explosives, a one-hundred foot roll of fuse, and some fuse-type blasting caps. He said he wanted them for the night of November 22, 1971, but did not say what for. Most likely, he only wants to sell them to someone. He also asked GODFREY if he could provide him with armed cover for the night of November 22, 1971, beginning at about 7:00 p.m. He said he would have to work late as he is building a fence for the Balboa Fence Company at the Rincon, somewhere near Santa Barbara. GODFREY hedged about going along with DAVIS and said he did not know if he could arrange it. DAVIS then said not to worry about it as he could easily get someone else.

Last Sunday, SAM DAVIS, ROGER DRAPEAU, BARRY GODFREY, and STAN MC DADE and his two sons, BRENT and MARK, went out to the desert in DRAPEAU's Van. SAM DAVIS had obtained some maps from BETTIE HAUGHTON, which allegedly showed the locations of some of TROY HAUGHTON's caches of arms, ammunition and other equipment. The particular map that was used Sunday, was hard to read; however, it is believed that the place marked on the map was actually located. The story regarding this particular cache is that several years ago TROY HAUGHTON and some of his companions went on a week long maneuver in the desert near the Banner Grade east of Julian, California. During this week of maneuvers, they supposedly built a cache of weapons and ammunition on the side of a cliff near the highway and made a map to show its location. On Sunday, we found a place where a beautiful hand laid rock wall had been made against the side of a cliff within sight of the Banner Grade Highway. We took the wall down and dug back into the cliff a considerable distance but found nothing. It is the intention of this group to check this site again at a later date with a metal detector.

According to DAVIS, most of TROY HAUGHTON's other caches of arms and ammunition as shown on the other maps he has are in the Needles and Rice, California areas.

Genome

Date prepared

2/2/72

Date received

11/26/71

Received from (name or symbol number)

Informant
SD 155-E

Received by

SA Steven L. Christensen

Method of delivery (check appropriate blocks)

in person by telephone by mail orally recording device written by Informant

If orally furnished and reduced to writing by Agent:
Date

Dictated _____ to _____

Transcribed _____

Authenticated by Informant 2/2/72

Date of Report

11/26/71

Date(s) of activity

Current

Brief description of activity or material

Info re Sam Davis, Cy Anderson
James Poto, Frank Yacopac, Robert
Mayer

File where original is located if not attached

* INDIVIDUALS DESIGNATED BY AN ASTERISK (*) ONLY ATTENDED A MEETING AND DID NOT ACTIVELY PARTICIPATE. VIOLENCE OR REVOLUTIONARY ACTIVITIES WERE NOT DISCUSSED.

Information recorded on a card index by _____ on date _____

Remarks:

157-3001 (Davis)
170-286A-134
157-28 (SAO)
157-1816 (Poto)
157-1820 (Yacopac)
157-2931 (Mayer)

Index: Cy Anderson to 157-3001
157-286A-28

1- Seattle
1- 157- (Cy Anderson)

Block Stamp

170-286A-134

SEARCHED INDEXED

SERIALIZED FILED

FEB - 1 1972

FBI - SAN DIEGO

[Signature]

JEROME
November 26, 1971

I have been in contact with SAM DAVIS. I learned from him that CY ANDERSON resides at 10418 Northeast 168th Place, Bothell, Washington, and has telephone numbers 206-485-4854 and 206-454-8912. His wife's name is DEE.

DAVIS claims that he has already spent \$300 of his personal money on printing and materials for the SAO. He said he is still thinking about a trip to Phoenix, Arizona, Texas, and Mexico.

He also mentioned that JAMES EVAN POTO is getting ready to go to Illinois. He said POTO is working in San Diego for a nation wide chain of restaurants and has been asked to go to Illinois to start a new restaurant somewhere in that state.

I have also talked to FRANK YACOPEC, who said he is going to take a vacation trip to Chicago, Illinois and vicinity in December. He said he would drop by Norborne, Missouri, where the Minutemen Headquarters was located, and put SAO stickers up all over town.

He said he and ROBERT MAYER are working at setting up a little citizens band radio network and will try to provide mobile units to put in the cars of various right wingers. These mobile units will probably be stolen. He said they are also working on a code to use and are still making plans on how to take over radio station KSON's Broadcast Antenna in order to play a right wing propaganda tape.

Jerome

Date prepared

2/2/72

Date received

11/29/71

Received from (name of symbol number)

Informant
SD 155-E

Received by

SA Steven L. Christensen

Method of delivery (check appropriate blocks)

in person by telephone by mail orally recording device written by Informant

If orally furnished and reduced to writing by Agent:

Date

Dictated _____ to _____

Transcribed _____

Authenticated by Informant 2/2/72

Date of Report

11/29/71

Date(s) of activity

11/29/71

Brief description of activity or material

Info re MIC

File where original is located if not attached

* INDIVIDUALS DESIGNATED BY AN ASTERISK (*) ONLY ATTENDED A MEETING AND DID NOT ACTIVELY PARTICIPATE. VIOLENCE OR REVOLUTIONARY ACTIVITIES WERE NOT DISCUSSED.

Information recorded on a card index by _____ on date _____

Remarks:

100-14427

170-286A-135

170-286A-135

Block Stamp

SEARCHED	INDEXED
SERIALIZED	FILED
MAR - 1 1972	
FBI - SAN DIEGO	
<i>Christensen</i>	

JEROME

November 29, 1971

I have learned from a contact of mine in the telephone company that the Message Information Center was last located at 2225 A Street, San Diego. However, their telephone at that location was recently disconnected for non-payment. The loss of the telephone service is probably the reason for Message Information Center going out of business.

Jerome

Date prepared

2/8/72

Date received

12/9/71

Received from (name or symbol number)

Informant
SD 1155-E

Received by

SA Steven L. Christensen

Method of delivery (check appropriate blocks)

in person by telephone by mail orally recording device written by Informant

If orally furnished and reduced to writing by Agent:

Date

Dictated _____ to _____

Transcribed _____

Authenticated by Informant 2/2/72

Date of Report

12/9/71

Date(s) of activity

Current

Brief description of activity or material

Bill Clay, Sam Davis, Stan McDade, SAO, Bettie Haughton

File where original is located if not attached

* INDIVIDUALS DESIGNATED BY AN ASTERISK (*) ONLY ATTENDED A MEETING AND DID NOT ACTIVELY PARTICIPATE. VIOLENCE OR REVOLUTIONARY ACTIVITIES WERE NOT DISCUSSED.

Information recorded on a card index by _____ on date _____

Remarks:

- 157-2305 (Clay)
- 170-286A-136
- 157-3001 (Davis)
- 157-2933 (McDade)
- 157-1813 (Haughton)
- 157-2815 (SAO)
- 157-3007 (Guire)
- 157-1614 (Haughton)
- 100-16200 (CALREP)
- 100-13847 (SMC)

Index: Forrest Rogers to
 157-2305; Hugh Lance to
 157-1813; ~~SAO~~ Michael Brooks & Stan
 O'Neil to 100-13847.
 1- 157-2822 - Ev Moore -
 100-12461-629, 689

170-286A-136

Block Stamp

- 1- Los Angeles
- 1- 157- (Hugh Lance)
- 1- Phoenix
- 1- 157- (Ev Moore)

SEARCHED INDEXED
 SERIALIZED FILED

S. Christensen

170-286

JEROME
12/9/71

The information regarding BILL CLAY's involvement in the Witches Coven on the University of California at San Diego campus originally came from SAM DAVIS and STAN MC DADE. He has been in the Witches Coven for over a year now and I believe he is still involved with it. Apparently, his main interest in this group is the sexual promiscuity of the women who are involved.

With regard to explosives, I have no personal knowledge of any caches buried in the desert or elsewhere on CLAY's part, although he did claim to have made such caches. I have seen him in possession of metal cans or boxes full of dynamite and other explosives which he claimed to have dug up from such a place. I have also known him to be in possession of other explosives and believe he still has the rented garage which I, at one time, observed to be chuck full of .30 caliber carbine ammunition. In addition, SAM DAVIS told me that at one time he saw at least \$500 worth of gold in CLAY's garage.

The current information on CLAY is that he is running around with FORREST (FROSTY) RODGERS. RODGERS is the full-time west coast leader of the JOHN BIRCH Society. I was told that CLAY and RODGERS do a lot of flying together.

BETTIE HAUGHTON is doing all of the printing for the SAO on her off set press which is now located at WALT GUIRE's house. She is also helping on organizational work for the SAO and has provided contact lists which may contain as many as 600 names of former contacts of TROY HAUGHTON. Most of these names, however, are probably just those appearing on mailing lists rather than actual contacts.

In addition, BETTIE HAUGHTON still makes frequent trips north to the place owned by HUGH LANCE near Big Pine, California.

With regard to the 1972 Republican National Convention, SAM DAVIS told me the other day that he is busy setting up an alibi for him to use during the convention. His plan is to give the impression of being out of town during the convention by driving his car to Arizona and pretending to stay there with EV MOORE. He will have MOORE cover for him as though he were in Phoenix when actually he will fly back to San Diego to commit various acts of harassment, etcetera, during the convention following which he will fly back to Phoenix and then drive home.

Two individuals named MICHAEL BROOKS and STEVEN O'NEIL have come to my attention. These persons are, or were, running the SMC Organization at Grossmont Junior College. However, BROOKS may now be attending school at San Diego State College. BROOKS and O'NEIL supposedly are still residing together. This information came from BROOKS' older brother.

O'NEIL'S YOUNGER

Jerome

Date prepared

2/8/72

Date received

12/20/71

Received from (name or symbol number)

Informant
SD 1155-E

Received by

SA Steven L. Christensen

Method of delivery (check appropriate blocks)

in person by telephone by mail orally recording device written by Informant

If orally furnished and reduced to writing by Agent:

Date

Dictated

_____ to _____

Transcribed

Authenticated by Informant

2/2/72

Date of Report

12/20/71

Date(s) of activity

12/20/71

Brief description of activity or material

Info re George Hoover, Frank Yacopac, Robert Mayer, Sam Davis

File where original is located if not attached

* INDIVIDUALS DESIGNATED BY AN ASTERISK (*) ONLY ATTENDED A MEETING AND DID NOT ACTIVELY PARTICIPATE. VIOLENCE OR REVOLUTIONARY ACTIVITIES WERE NOT DISCUSSED.

Information recorded on a card index by _____ on date _____

Remarks:

- 157-3017 (Hoover)
- ① 170-286A-137
- 100-14819 (Godfrey)
- 157-1820 (Yacopac)
- 157-2931 (Mayer)
- 157-2815 (SAB)
- 157-3001 (Davis)
- 157-2933 (McDade)
- 157-1014 (Naughton)
- 157-28 (NSWPP)
- 100-15450 (Bohmer)

Index: Jesse Clayburn Stevens to 157-2815 - also Robert De Pugh, Glenn Jackson, John Zemann³⁵⁵, John Zemann¹⁰⁰⁻¹⁴⁵⁴¹, "~~American Volunteer Group~~", Alex Rapid Print.

Info re sample of metal alleged to be gold: sample shown to SA Roy Rymill, formerly a geologist. Stated sample is copper, not gold, & appears to be "native" copper.

100-14541 - American Block Shop

3 - Los Angeles

- 1-157 (Glenn Jackson)
- 1-157 (John Zemann)
- 1-157 (American Volunteer Group)

1 - Baltimore

170-286A-137

SEARCHED INDEXED
SERIALIZED FILED
FBI - SAN DIEGO

Christensen file

December 20, 1971
By Jerome

GEORGE HOOVER was at my house this morning and left with me a sample of the metal which he alleges is stolen government gold. He said he has come to the conclusion that the metal must be a gold-platinum alloy because of the high melting temperature it has.

BARRY GODFREY told me that FRANK YACOPEC and ROBERT MAYER went by the house at 3121 Beech Street in an attempt to get at the printing press located there to destroy it. Apparently, they were not able to accomplish anything there as I have not heard of anything happening.

YACOPEC is now gone to Los Angeles, California, on a trip following which he will travel to Gary, Indiana, to visit with his brother. He said he will try to do some recruiting for the SAO while there, and will put up SAO stickers and leaflets wherever he can.

Friday I was at SAM DAVIS' house where I observed a letter to DAVIS from JESSE CLAYBURN STEVENS at Silver Springs, Maryland. In the letter, STEVENS talked of how he and his group hated ROBERT DE PUGH and stated that he was in contact with GLENN JACKSON and JOHN ZEMANEC of the American Volunteer

Group at Los Angeles. STEVENS, who knows SAM DAVIS only by the name PATRICK MC DONALD, stated that he was anxious to get in touch with right-wing groups or individuals in the Southern California area. He advised he had received some SAO literature but said he corresponds with several individuals in the San Diego area and did not know who had furnished him with the SAO literature. (This was STAN MC DADE).

I also observed DAVIS' reply to STEVENS in which he stated that the SAO was also interested in making contact with STEVENS' group and other similar groups in the East. He said that the SAO remains Minuteman at heart and in principle regardless of the name or form it might take.

The SAO has had printed 200 copies of an information sheet on PETER BOHMER, which is to be distributed to right-wing activists and other individuals in the San Diego area. The printing was done by ALEX (LNU) at Alex Rapid Print House, and the only charge was \$3.50 for the materials. So far, SAO has spent \$140 on printing its literature, most of which has come out of the pockets of DAVIS and GODFREY. The stamps for this SAO mail-out alone will cost \$16.

ALEX of Alex Rapid Print is a former Minuteman who allowed TROY HAUGHTON to do all of the West Coast Minuteman print work on his equipment. He has now agreed to do all of the SAO printing work at cost.

While I was at work the other day, a colored individual came in to report a leak in a water main. He was driving an old pickup truck with California license M30319 and was wearing a chrome-plated Nazi helmet with an American flag painted on it. I don't know what significance this might have.

With regard to the Nazis, I have learned that their new headquarters is located at 7720 University in La Mesa and is called the White Power Information Center.

I also understand that the SAO may attempt to run a poster campaign on Camp Pendleton as there are suppose to be a lot of good recruit possibilities there.

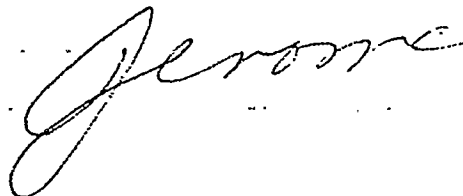
A handwritten signature in cursive script, appearing to read "J. J. Jones".

Date prepared

2/15/72

Date received

12/28/71

Received from (name or symbol number)

Informant
SD 1185-E

Received by

SA Steven L. Christensen

Method of delivery (check appropriate blocks)

in person by telephone by mail orally recording device written by Informant

If orally furnished and reduced to writing by Agent:

Date

Dictated _____ to _____

Transcribed _____

Authenticated by Informant _____

Date of Report

12/28/71

Date(s) of activity

12/27/71

Brief description of activity or material

Info re Sam Davis, Bettie Haughton
Ron Zarick.

File where original is located if not attached

* INDIVIDUALS DESIGNATED BY AN ASTERISK (*) ONLY ATTENDED A MEETING AND DID NOT ACTIVELY PARTICIPATE. VIOLENCE OR REVOLUTIONARY ACTIVITIES WERE NOT DISCUSSED.

Information recorded on a card index by _____ on date _____

Remarks:

157-3001 (Davis)
170-286A-138
157-1813 (Haughton)
157-2921 (Zarick)
157-2815 (SAO)

Index: Ed Carville to 157-2815

1- Los Angeles
1-157- (Hugh Lance)

Block Stamp

170-286A-138

SEARCHED INDEXED
SERIALIZED FILED

FBI - SAN DIEGO

Christensen

12/28/71

BY JEROME

I was in contact with SAM DAVIS yesterday. He told me that BETTIE HAUGHTON told him she has decided to remarry soon, probably about June, 1972. DAVIS did not tell me the name of the person she is to marry but identified him as the new owner of the Lodge at Big Pine or Lone Pine, California, which formerly belonged to HUGH LANCE. DAVIS said that apparently LANCE is now a Deputy Sheriff in Inyo County.

RON ZARICK told me yesterday that he has been fired from the last job he had.

I do not know the person named ED CARVILLE who received one of the SAO bulletins one PETER GEORGE BOHMER. Apparently he was just on the membership list which the SAO got from BETTIE.

Date prepared

2/15/72

Date received

12/29/71

Received from (name or symbol number)

informant
SD 155-E

Received by

SA Steven L. Christensen

Method of delivery (check appropriate blocks)

in person by telephone by mail orally recording device written by Informant

If orally furnished and reduced to writing by Agent:

Date

Dictated _____ to _____

Transcribed _____

Authenticated by Informant _____

Date of Report

12/29/71

Date(s) of activity

12/28/71

Brief description of activity or material

Info re Lyle Manning at Utah; Right Wing activities in San Diego area

File where original is located if not attached

* INDIVIDUALS DESIGNATED BY AN ASTERISK (*) ONLY ATTENDED A MEETING AND DID NOT ACTIVELY PARTICIPATE. VIOLENCE OR REVOLUTIONARY ACTIVITIES WERE NOT DISCUSSED.

Information recorded on a card index by _____ on date 1/15/72 - 9

Remarks:

- 100-14299 (Manning)
- 170-286A-139 ✓
- 157-2177 (Forrest)
- 100-14819 (Godfrey)
- 157-2815 (SAO)
- 157-3001 (Davis)
- 157-1816 (Poto)
- 157-1614 (Haughton)
- 157-3006 (Guire)
- 157-3007 (Guire)

Index: "Doc" Roberts to 100-14299.
Jesse Clayburn Stevens to 157-2815.

170-286A-139
Block Stamp

- 2- Salt Lake City
- 1- 157- (Lyle Jack Manning)
- 1- 157- ("Doc" Roberts)
- 1- Baltimore
- 1- 157- (Jesse Clayburn Stevens)

SEARCHED INDEXED
SERIALIZED FILED
FEB - 2 1972
FBI - SAN DIEGO

Christensen - ml

12/29/71

BY JEROME

I received a telephone call last night from LYLE MANNING at Richfield, Utah. He has telephone number 801-896-5262, and gave me his address as Post Office Box 412, Richfield, Utah. He told me he is now employed taking care of the fair grounds and race track at Richfield. MANNING claimed that he and "DOC" ROBERTS are trying to form a right-wing activist group at Richfield and asked me to send him all the Minuteman literature that I could get for him. He also indicated that he and ROBERTS will be visiting the San Diego area about the middle of January, 1972. He said the purpose of their trip will be to obtain all the .30-06 and .308 caliber ammunition that they can find. He asked me to start looking around for this ammunition for him.

I visited TOM FORREST's place last night and learned that somehow he is obtaining a large number of the top halves for M-16 rifle receivers. Apparently the only real difference between the M-15 rifle, which is semi-automatic, and the M-16 rifle, which is fully automatic, lies in the top half of the receivers. He claims to have no trouble selling all these items that he can get ahold of and he must have a good source for such weapon parts.

BARRY GODFREY told me that SAM DAVIS has received more correspondence from JESSE CLAYBURN STEVENS from Silver Springs, Maryland. In his letters STEVENS agreed to the formation of an alliance between the SAO and his group. According to the guidelines which were set up, STEVENS' group will have control over right-wing activities in the east and in the south while the SAO will control all activities in the western and northern states. Both groups will work at trying to find and establishing a coordinate at or near Chicago, Illinois, to handle all activities in the mid-west area. GODFREY said that a good possibility for this job would be JIM POTO. He pointed out that POTO works for a national restaurant chain, possibly Howard Johnson in San Diego, as a restaurant manager. POTO has indicated that he expects to be transferred in the near future to the Chicago area to open a new restaurant and if so, he would make an ideal coordinator for the mid-west group.

In addition, arrangements were made in the letters from STEVENS to trade information between the two groups on people of interests to them who reside in each others areas. In other words, if the SAO has information on a prospective right-wing contact or other such person residing in the area controlled by STEVENS' group, this information would be sent to this group and vice versa.

Furthermore an agreement was made to transfer members of the SAO and STEVENS' group who move from one area to another.

STEVENS advised that his group has micro-filming equipment in it's possession. GODFREY claimed that the SAO will also obtain such equipment as soon as it possibly can and in the future, all "secure" messages between the two groups will be transmitted by micro-film.

In addition, STEVENS claimed that his group is very much opposed to ROBERT BOLIVAR DE PUGH and claimed to have information pertaining to TROY HAUGHTON's death, indicating he may know someone who was involved in his murder. He indicated that he would communicate with the SAO on this matter later on. GODFREY said in his letters, STEVENS indicated he is very anti-police, FBI and informers. He said if he could he would kill them all, drop them in a hole in the desert and pore lye on them. STEVENS offered to travel to San Diego to visit with leaders of the SAO and arrangements have been made.

GODFREY said that DAVIS has been working hard on the next bulletin of the SAO and now has it ready to go to the printers. This bulletin will be ten pages long and will consist of eight pages of technical information pertaining to explosives, booby traps, and other similar items. The other two pages will contain general information relating to news, recruiting, training, etc.

GODFREY also said that WALT and EDITH GUIRE have now agreed to do research for the SAO on subjects of interest to the organization. The GUIRES reside at 4114 Massachusetts, La Mesa, California, where they have telephone number 463-4648.

Date prepared

2/18/72

Date received

1/6/72

Received from (name or symbol number)

[SD 1155-E] Informant

Received by

SA Steven L. Christensen

Method of delivery (check appropriate blocks)

in person by telephone by mail orally recording device written by Informant

If orally furnished and reduced to writing by Agent:
Date

Date of Report

1/6/72

Dictated _____ to _____

Date(s) of activity

Transcribed _____

Authenticated by Informant _____

1/4/72

Brief description of activity or material

Info re Gerald L. Smith and
NSWPP

File where original is located if not attached

* INDIVIDUALS DESIGNATED BY AN ASTERISK (*) ONLY ATTENDED A MEETING AND DID NOT ACTIVELY PARTICIPATE. VIOLENCE OR REVOLUTIONARY ACTIVITIES WERE NOT DISCUSSED.

Information recorded on a card index by _____ on date _____

Remarks:

157-201 (Smith)
170-286A-140
157-28 (NSWPP)
157-2931 (Mayer)
- Los Angeles
1-157-6836 (NSAWP)
1-157- (NSWPP)
1-157- (Scott Winchester)
1-157- (Joseph Tomasi)

Index: Chuck Sperry to
157-2931 - also Chuck Pearce
No dissemination required on
Chuck Pearce as he is only
a gun collector and not
involved in any extremist
activities.

Block Stamp

170-286A-140
SEARCHED INDEXED
SERIALIZED FILED
FBI - SAN DIEGO
Christensen

1/6/72

BY JEROME

ADDITIONAL INFORMATION RECALLED FROM MY VISIT
WITH GERALD SMITH OF THE NSWPP.

He always goes armed to the NSWPP meetings as do all members of the group. I suspect that these people are generally armed at all times. However SMITH indicated to me that he and the NSWPP do not believe in violent armed revolutions at this time.

He explained this position by stating that he believes that there really are no such things as political questions or issues. He said he believes the basis for all such political questions and issues actually lies in racial concerns. He said because of this he feels that eventually the people in the United States will become fed up with racially oriented oppressions and will vote the NSWPP into power at the polls, hence no need for a revolution.

SMITH has a weird appearance and is not physically tough looking as you might expect a Nazi to be.

BOB MAYER is now living at 2204 Mt. Clair Street, San Diego, California and has telephone number

284-3697. The house at this address was purchased by him from CHUCK SPERRY, ~~the~~ local leader of the John Birch Society. As you will remember MAYER is supposed to marry SPERRY's daughter soon. MAYER, who was formerly a Marine, spent some time in Vietnam and claims to have been wounded there.

The other person referred to is CHUCK PEARCE. He is a member of the Army's Special Forces Unit in San Diego.

With regard to the two Nazi factions at Los Angeles I have heard that JOE TOMASI claims that SCOTT WINCHESTER's group is defunct, however WINCHESTER claims his group is still going and is the most active.

Jerome

Date prepared

2/2/72

Date received

11/5/71

Received from (name or symbol number)

[SD1155 - E] Informant

Received by

SA Steven L. Christensen

Method of delivery (check appropriate blocks)

in person by telephone by mail orally recording device written by Informant

If orally furnished and reduced to writing by Agent:

Date

Dictated _____ to _____

Transcribed _____

Authenticated by Informant 2/2/72

Date of Report

11/5/71

Date(s) of activity

11/5/71

Brief description of activity or material

Contact with Sam Davis; info re
Scott Winchester; Contact with Stan
McDade

File where original is located if not attached

* INDIVIDUALS DESIGNATED BY AN ASTERISK (*) ONLY ATTENDED A MEETING AND DID NOT ACTIVELY PARTICIPATE. VIOLENCE OR REVOLUTIONARY ACTIVITIES WERE NOT DISCUSSED.

Information recorded on a card index by _____ on date _____

Remarks:

157-3001 (Davis)

~~170-286A-141~~

157-28 (NSWPP)

157-2933 (McDade)

157-1798 (MM)

100-14427 (MIC)

157-2815 (SAO)

2 - Los Angeles

1 - 157-8836 (NSAWP)

1 - 157- (Scott Winchester)

1 - 157-2398 (Scott Winchester)

Index: ~~_____~~ to

157-28 ; "On Target" to

157-1798.

170-286A-141

Block Stamp

SEARCHED	INDEXED
SERIALIZED	FILED
MAR 2 1972	
FBI - SAN DIEGO	

[Handwritten signature]

JEROME
November 5, 1971

I was talking with SAM DAVIS this morning and he told me that SCOTT WINCHESTER's Nazi Group at Los Angeles has folded up. He said WINCHESTER apparently did not think his group was doing anything worthwhile. I am supposed to meet with DAVIS tomorrow to discuss our strategy with regard to WINCHESTER and his group. DAVIS wants me to go with him to Los Angeles next Saturday to talk with WINCHESTER as it appears that WINCHESTER and the supporters he has left may now be ready to join the SAO.

I was also by the old address of the Message Information Center earlier today. It looks to me as though the Message Information Center may have moved as the building where it used to be is now being remodeled into a very plush office space.

I was also talking to STAN MC DADE who told me he had received in the mail a brand new issue of "On Target" which came from Maryland and which claimed to be the place of the Minuteman Organization. I will attempt to obtain the publication from him. He said he has no idea as to how the publishers of the paper might have obtained his name and address, although he said he did write to a gun parts shop in Maryland approximately one week before he received the paper.

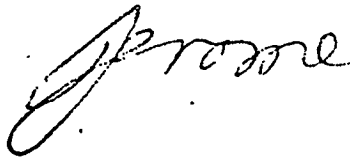

Date prepared

2/8/72

Date received

12/15/71

Received from (name or symbol number)

SD 1155- Informant

Received by

SA Steven L. Christensen

Method of delivery (check appropriate blocks)

in person by telephone by mail orally recording device written by Informant

If orally furnished and reduced to writing by Agent:

Date

Dictated _____ to _____

Transcribed _____

Authenticated by Informant 2/2/72

Date of Report

12/15/71

Date(s) of activity

12/15/71

Brief description of activity or material

Info re Jerry Lee Busch, George Hoover, Peter Bohmer, Ron Zarick, Barry Godfrey

File where original is located if not attached

* INDIVIDUALS DESIGNATED BY AN ASTERISK (*) ONLY ATTENDED A MEETING AND DID NOT ACTIVELY PARTICIPATE. VIOLENCE OR REVOLUTIONARY ACTIVITIES WERE NOT DISCUSSED.

Information recorded on a card index by _____ on date _____

Remarks:

- 100-15355 (Busch)
- 170-286A-142
- 170-26 sub-1
- 100-15450 (Bohmer)
- 157-2815 (SAO)
- 157-2921 (Zarick)
- 157-3017 (Hoover)
- 100-14939 (Busch)
- 100-14819 (Godfrey)
- 100-15971 (Box)

Index: Scottie Schultz to 157-2921 - ~~20~~ Bud Kitchens
 1-92-9740
 Info re Ron Zarick & Scottie Schultz furnished to SI Larry Clendinen, ATF O on 12/14/71.

Block Stamp

170-286A-142

SEARCHED INDEXED
 SERIALIZED FILED

FBI - SAN DIEGO

W. Christensen

December 15, 1971
By Jerome

It has come to my attention that JERRY LEE BUSCH, GEORGE HOOVER, and one or two of their friends have been present at the protest demonstrations sponsored by the supporters of PETER BOHMER. Apparently, they were taking photographs and gathering other information for the use of SAO. The SAO, by the way, wants to put out a counter-intelligence type bulletin on BOHMER for the purpose of informing right wing activists in this area as to what is going on with regard to BOHMER, and also to create a stir and cause some concern for their safety among the left wing activists.

It has come to my attention by way of RON ZARICK, who I talked to yesterday, that there is an individual named SCOTTIE SCHULTZ in the area. SCHULTZ is known to be an informer for ATFD and is believed to have been responsible for setting up the arrest and conviction of BUD KITCHENS. He has been gone from the San Diego area for a considerable period of time but is back nosing around again. ZARICK said there seems to be particular interest in JOHN BUSH on the part of ATFD and ZARICK feels BUSH may be the next one to be arrested.

I have learned from BARRY GODFREY that he and GEORGE HOOVER went by The Box commune at 5155 Muir last night. No particular activity was observed; however, the following vehicles and license plate numbers were observed:

Yellow Ford Van with California license CHG 687;

Light blue Plymouth Valiant two-door with California license HMJ 385;

Green Dodge Dart two-door with California License RGH 420;

White Chevrolet Corvair (parked in driveway next to house - license number not seen);

The telephone number for the telephone at The Box is 222-7243.

Godfrey

Date prepared

2/8/72

Date received

12/13/71

Received from (name or symbol number)

SD 1155-E Informant

Received by

SA Steven L. Christensen

Method of delivery (check appropriate blocks)

in person by telephone by mail orally recording device written by Informant

If orally furnished and reduced to writing by Agent:

Date

Date of Report

12/13/71

Dictated _____ to _____

Date(s) of activity

Current

Transcribed _____

Authenticated by Informant 2/2/72

Brief description of activity or material

Info re Tom Forrest, Sam Davis,
Stan McDade, Benny Godfrey

File where original is located if not attached

* INDIVIDUALS DESIGNATED BY AN ASTERISK (*) ONLY ATTENDED A MEETING AND DID NOT ACTIVELY PARTICIPATE. VIOLENCE OR REVOLUTIONARY ACTIVITIES WERE NOT DISCUSSED.

Information recorded on a card index by _____ on date _____

Remarks:

157-2177 (Forrest)
170-286A-143
170-26 sub
157-3001 (Davis)
157-2933 (McDade)
100-14819 (Godfrey)

Index: FNU Larkin to 157-2177
Bill Guiette + Chuck Pearce to
100-14819; "Minuteman Armory"
to 157-3001.

Information re Forrest and
Larkin furnished to SI Larry
Clendinen, ATFD, 12/17/71.

Block Stamp

170-286A-143

SEARCHED INDEXED
SERIALIZED FILED

FBI - SAN DIEGO

Christensen, ml

December 13, 1971
By Jerome

I had a conversation with TOM FORREST yesterday. He said he had received information that there is a ATFD informant working in this area again and he wanted to make sure that everyone was alerted. He said this individual is named (FNU) LARKIN, is about 50 years old, 5'8" tall, 150 pounds, with short red hair and a red complexion. Apparently ATFD has attempted to use this individual in the San Diego area on previous occasions. I was told that LARKIN was trying to sell 40 machine guns to SAM DAVIS.

SAM DAVIS and STAN MC DADE are attempting to raise enough money to open a gun shop in this area which will be called the "Minuteman Armory".

Along the same line, BILL GUIETTE of Bullseye Gun Shop; CHUCK PEARCE of the John Birch Society; and BARRY GODFREY of the SAO, are to get together and set up an ammunition dump somewhere in the desert.

They have also discovered that receivers for light .30 caliber machine guns can be easily manufactured with a regular milling machine from flat pieces of steel which are then welded together. The "Minuteman Armory" may involve itself in manufacturing some of these receivers.

Jerome

Date prepared

2/8/71

Date received

12/17/71

Received from (name or symbol number)

[SD 1155-E] Informant

Received by

SA Steven L. Christensen

Method of delivery (check appropriate blocks)

in person by telephone by mail orally recording device written by Informant

If orally furnished and reduced to writing by Agent:

Date

Dictated _____ to _____

Transcribed _____

Authenticated by Informant 2/2/72

Date of Report

12/17/71

Date(s) of activity

Current

Brief description of activity or material

Info re Right Wing activities in San Diego area.

File where original is located if not attached

* INDIVIDUALS DESIGNATED BY AN ASTERISK (*) ONLY ATTENDED A MEETING AND DID NOT ACTIVELY PARTICIPATE. VIOLENCE OR REVOLUTIONARY ACTIVITIES WERE NOT DISCUSSED.

Information recorded on a card index by _____ on date _____

Remarks:

- 157-3017 (Hoover)
- 170-286A-144
- 100-14301 (Ruplinger)
- 157-2832 (Carey)
- 100-14807 (Jerry Geier)
- 100-14819 (Godfrey)
- 170-26 sub.
- 157-2933 (McDade)
- 157-2439 (Weatherby)
- 157-201 (Smith)
- 157-28 (NSWPP)
- 157-3017 (Hoover)
- 157-2815 (SAO)
- 157-14242 (Joseph Brinken)
- 157-14303 (Victor Walton)

Info. re theft of ROTC wpns. from armory at Sweetwater High School disclosed with Detective Steven Scarpiti, National City PD, 12/28/71. He advised he could find no information relating to alleged incident but would contact FBI later if anything was learned.

Block Stamp

170-286A-144

SEARCHED INDEXED SERIALIZED FILED

FBI - SAN DIEGO

Christensen ML

December 17, 1971
By Jerome

I was in contact with GEORGE HOOVER yesterday. He claimed that he, in turn, is in contact with some individuals, whose identities he did not even hint at, who claim to have possession of a large quantity of stolen U.S. government gold.

According to HOOVER, this gold is in a 55 gallon drum and must weigh close to 1,000 pounds. He said the gold, of which he has a sample, is in small pieces which have the appearance of having been melted. HOOVER said he has been asked by these other individuals to help sell the gold. He said the idea is to package it in ten or twenty pound lots but did not know what the asking price would be. He said he would furnish me a sample of this material tomorrow, which I could take to PAUL RUPLINGER or some other place and have analyzed. He said the people selling the gold will want as much for it as they can get.

HOOVER, himself, continues to reside in housing furnished for him at the Wood King Wood Yards on Magnolia near Santee. He is currently employed making deliveries of

wood for the Wood Yards, receiving \$5 per delivery. He claims to be making six to eight deliveries a day.

With regard to DON CAREY, it has come to my attention that he has recently been spreading rumors designed to place JERRY GEIER, BARRY GODFREY, and others in a bad light with other right-wing activists. However, most people who know CAREY do not pay much attention to him as it is generally held that he is "nuts" and is really flipping out. I do not think CAREY is currently employed. He is described as follows:

Race	White
Age	Approximately 40 (looks younger)
Sex	Male
Height	5'7" - 5'8"
Weight	150 pounds
Build	Wiry
Hair	Very dark colored

He resides with his mother, JEANETTE WORDELL, at 4069 El Cajon Boulevard, where he has telephone number 284-7807. He also claims to have a place at Campo for use as a hide-out if necessary. To the best of my recollection, he drives a gray Jeep-type Toyota vehicle.

Last night I was at JERRY GEIER's house. The conversation got around to the theft, some time ago, of weapons from the ROTC Armory at Sweetwater High School. GEIER said that the evening before the theft, he received a telephone call

from a friend (unnamed) who asked him if he wanted some BAR's and other similar weapons, to which GEIER replied that he did. His friend said he had a line on a supply of such weapons and that they would be available the following night. GEIER said that on the next night he and his friend went to a pre-arranged location, picked the weapons up and brought them back to GEIER's residence where they were stored in the garage. According to GEIER, the following morning when he went to work, a fellow employee jokingly asked him if he had purchased any machine guns. GEIER said "What do you mean?", whereupon the other individual pointed out to him an article in the paper regarding the theft of weapons from the Sweetwater High School ROTC Armory. GEIER said he checked the list of weapons reported to have been stolen against those he had purchased the previous evening and found it to match exactly. He said he immediately dashed home, wiped all the weapons down for fingerprints, and returned them to the source from which they had been obtained. However, neither he nor his friend received any money back that they had already paid for the weapons.

GEIER said that the source of the weapons was the son of the Army Sergeant regularly assigned to the ROTC Unit at Sweetwater High School. He said this individual apparently backed

a truck into the wall of the room containing the ROTC weapons, breaking a large hole through the which the weapons were loaded into the truck. GEIER said that after the weapons were returned to the Army Sergeant's son, he took them to the Singing Hills Golf Course where they were later found laying on the grass.

Word has come to me from STAN MC DADE that WILLIAM WEATHERBY has either quit or been dropped from the NSWPP. He may be the Lieutenant of GERALD L. SMITH who quit when ordered by SMITH to leave his Mexican wife. I understand that GEORGE HOOVER is working to recruit WEATHERBY for the SAO.

It has also come to my attention that the NSWPP has opened a formal headquarters and office space either on University or El Cajon Boulevard in La Mesa. The rent for this space is \$125 per month, and I believe is being financed primarily by VIC WALTON and/or JOE BRINKER.

I have also heard that BARRY GODFREY will be working with STAN MC DADE and GEORGE HOOVER to compile a list of the local NSWPP members. I don't know how many members may be left following the recent shake-up in that organization.

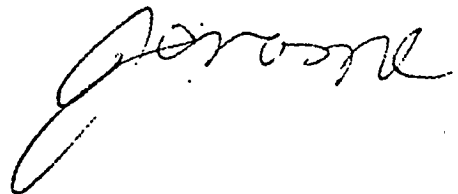
A handwritten signature in cursive script, appearing to read "George Hoover", is written in the lower right portion of the page.

Date prepared
2/18/72

Date received: 1/5/72
Received from (name or symbol number): [SDUSS-E] Informant
Received by: SA Steven L. Christensen

Method of delivery (check appropriate blocks)
 in person by telephone by mail orally recording device written by Informant

If orally furnished and reduced to writing by Agent:
Date _____
Dictated _____ to _____
Transcribed _____
Authenticated by Informant _____

Date of Report
1/5/72

Date(s) of activity
1/4/72

Brief description of activity or material
Info re NSWPP activities

File where original is located if not attached

* INDIVIDUALS DESIGNATED BY AN ASTERISK (*) ONLY ATTENDED A MEETING AND DID NOT ACTIVELY PARTICIPATE. VIOLENCE OR REVOLUTIONARY ACTIVITIES WERE NOT DISCUSSED.
 Information recorded on a card index by _____ on date _____

Remarks:
157-28 (NSWPP)
①70-286A-145
157-1798 (MM)
157-201 (Smith)
100-14303 (Victor Watson) } dual card.
100-16200 (CALREP) }
157-2545 (Wilson)
157-3017 (Hoover)
157-2933 (McDade)
157-2920 (Cropsey)
157-3001 (Davis)
157-2815 (SAO)

170-286A-145
Block Stamp

SEARCHED INDEXED
SERIALIZED FILED
FBI - SAN DIEGO
Christensen
170-286A-145

1/5/72

BY JEROME

Last night I went to the NSWPP White Power Information Center located at 7720 University, La Mesa, California and spoke with GERALD SMITH, using an assumed name. This is the first time that I have talked with SMITH and I found him to be very egotistical, highly talkative and very much down on the Minuteman organization and related right-wing activities. He claimed to know all of the Minuteman leaders and indicated that he and his group went on maneuvers with the Minuteman organization all the time. He stated that he thinks the Minuteman organization is comprised of a bunch of cowards who will not do anything to protect the country when the time comes. He impressed me as being really "nuts".

SMITH mentioned VIC WALTON as one of the backers of the NSWPP and hinted that most of the financing for his group comes from out-of-state. He said that his plans for the 1972 Replublican National Convention will include picketing of both the Republican and Left Wing groups.

According to SMITH, the NSWPP holds a meeting each Wednesday night at 7:30 PM which is open to the public.

This White Power Information Center is open on Tuesday, Thursday and Friday evenings from 6:00 to 8:30 PM and on Saturday afternoons.

He said the NSWPP rented the space for the White Power Information Center under the ruse that it was to be used for a book store, otherwise the group either would already have been evicted or never would have been rented the space in the first place.

While he was there, there was another strange looking young male individual with SMITH who he believed was named RAY WILLIAMS or WILSON. He was described as follows:

Race	White
Height	5'6"
Weight	130-135 pounds
Hair	Blond
Complexion	Pale
Build	Slender
Eyes	Blue
Dress	Wearing skin-tight pants and an Eisenhower jacket with a swastika on the collar.

I have heard that GEORGE HOOVER is attempting to wean this person away from SMITH.

In addition, from their conversation it appears that the NSWPP is down on STAN MC DADE.

I do not know of the individual named STEVEN LINN CROPSEY or anything about his involvement in the NSWPP.

I was in contact with SAM DAVIS who is in the process of making up a master file on right-wing activities. Hopefully I will have access to this information.

DAVIS also advised that the new ten page SAO bulletin has been printed and should be out tomorrow. He stated that he is anxious to start preparing another special intelligence bulletin to be put out by the SAO. This time he wants the target of the bulletin to be some nationally known figure in the new left, such as JERRY RUBEN, WILLIAM RUNSTLER or ABBIE HOFFMAN.

Jerome

Date prepared

3/14/72

Date received

1/7/72

Received from (name or symbol number)

SD 1155-E Informant

Received by

SA STEVEN L. CHRISTENSEN

Method of delivery (check appropriate blocks)

in person by telephone by mail orally recording device written by Informant

If orally furnished and reduced to writing by Agent:

Date

3/14/72

Dictated to Ronnie Wilson

Transcribed _____

Authenticated by Informant _____

Date of Report

1/7/72

Date(s) of activity

1/6/72 - 1/7/72

Brief description of activity or material

INFORMATION REGARDING S.A.O.

File where original is located if not attached

* INDIVIDUALS DESIGNATED BY AN ASTERISK (*) ONLY ATTENDED A MEETING AND DID NOT ACTIVELY PARTICIPATE. VIOLENCE OR REVOLUTIONARY ACTIVITIES WERE NOT DISCUSSED.

Information recorded on a card index by _____ on date _____

Remarks:

1-157-2815 (SAO)

cc:

1-170-286A-146

1-157-30001 (DAVIS)

1-157-2931 (MAYER)

1-100-14819 (GODFREY)

1-100-15450 (BOHMER)

J

170-286A-146

Block Stamp

SEARCHED	INDEXED
SERIALIZED	FILED
MAR 23 1972	
FBI - SEATTLE	
Christensen M	
170-286A-146	

1-SEATTLE DIVISION (CY ANDERSON)

January 7, 1972
By JEROME

I learned last night from BOB MAYER that he, SAM DAVIS, and BARRY GODFREY were at San Diego State College (SDSC) yesterday putting up SAO stickers, particularly around the office of Professor PETER BOHMER.

I understand that in the evening some harassing telephone calls were made by SAO members to the residence of Professor BOHMER.

SAM DAVIS brought to my attention the fact that CY ANDERSON is suppose to be in town from Seattle, Washington, next week. DAVIS said that ANDERSON is going to bring a large quantity of stuff to sell, including the following:

Military mountain style mummy sleeping bags at three for fifty dollars

New military field jackets with hoods at eleven dollars each and without hoods, nine dollars each

Parachute rifle grenades at two dollars a piece or six for ten dollars.

Military brass and steel cleaning rods

Two new AR-180's at \$210.00 each.

One used AR-14 at \$225.00.

One used high stand .22 caliber pistol at seventy dollars.

One used Colt Diamond Back .38 caliber pistol at \$90.00.

Jerome

One used M-1 carbine at seventy dollars.

One used M-2 carbine at one hundred thirty five dollars.

One used 1903 Springfield at sixty five dollars.

One used Model 97 Winchester Riot Gun at eighty five dollars.

DAVIS claims he has also contacted some acquaintances of his in Kansas and Oklahoma regarding establishing the SAO in those area. He further claimed to have recruited two unidentified individuals at Carson near Los Angeles, California, into the SAO. He also advised he has received letters of inquiry regarding the SAO from the Redding, California, area, and from some where in the State of Maryland.

Jerome

Date prepared

3/14/72

Date received

1/12/72

Received from (name or symbol number)

[SD 1155-E] Informant

Received by

SA STEVEN L. CHRISTENSEN

Method of delivery (check appropriate blocks)

in person by telephone by mail orally recording device written by Informant

If orally furnished and reduced to writing by Agent:

Date

Date of Report

Dictated 3/14/72 to RONNIE WILSON

1/12/72

Transcribed _____

Date(s) of activity

1/11/72

Authenticated by Informant _____

Brief description of activity or material

INFORMATION REGARDING SAO AND RIGHT WING

ACTIVISTS IN SAN DIEGO AREA

File where original is located if not attached

* INDIVIDUALS DESIGNATED BY AN ASTERISK (*) ONLY ATTENDED A MEETING AND DID NOT ACTIVELY PARTICIPATE. VIOLENCE OR REVOLUTIONARY ACTIVITIES WERE NOT DISCUSSED.

Information recorded on a card index by _____ on date _____

Remarks:

1-157-2815 (SAO)

cc:

- ①-170-286A-147
- 1-157-2931 (MAYER)
- 1-157-2933 (MC DADE)
- 1-157-3001 (DAVIS)
- 1-157-3017 (HOOVER)
- 1-157-1820 (YACOPEC)
- 1-100-14819 (GODFREY)
- 1-157-1813 (HAUGHTON)
- 1-100-15450 (BOHMER)



ACTION: With regard to information concerning TOM DRISCOLL of United States Customs, it is noted source advised DRISCOLL is known to have worked in the past with ATFD in setting up "shady" gun dealers and believed this was another similar attempt.

- 1-LOS ANGELES DIVISION (157-HUGH LANCE)
- 1-SEATTLE DIVISION (157-CY ANDERSON)

170-286A-147
Block Stamp

SEARCHED INDEXED
SERIALIZED FILED
APR 2 1972
FBI - SAN DIEGO
Christensen
1-170-286A-147

January 12, 1972
by JEROME

Yesterday BOB MAYER, STAN MC DADE, SAM DAVIS, NICK HOOVER, FRANK YACOPEC, "FAT JOHN" LENNOX (who has telephone number 284-1442) and LENNOX's shadow, a kid named DENNIS (LAST NAME UNKNOWN), were all at BARRY GODFREY's house discussing the shooting of a girl at Professor BOHMER's house and the implication that the SAO was responsible or at least involved. All those present were expecting to be interviewed regarding the shooting, and were bragging about what they were going to do when the police came to call. As usual, YACOPEC and MAYER were all excited about pulling off some big stunt.

DAVIS said he had been talking to BETTIE HAUGHTON, and according to her, the newspaper publicity which the SAO got in connection with the shooting incident, has stirred up a lot of interest among the Right Wing oriented individuals she knows. She told DAVIS she had received 25 to 30 contacts from people who formerly belonged to the Minutemen (MM) Organization who she said were interested in joining the SAO. She also told DAVIS she had showed some of the SAO literature to HUGH LANCE, who is suppose to be a Deputy Sheriff at either

Big Pine or Long Pine, California. She said he was very enthusiastic about the SAO and might join. DAVIS said we will have to make arrangements to contact him.

DAVIS mentioned he has another new SAO contact somewhere in the Los Angeles, California, area.

STAN MC DADE claimed to have received a telephone call from TOM DRISCOLL, a Customs Inspector at the Border at San Ysidro, California. DRISCOLL apparently asked MC DADE if he knew where DRISCOLL could purchase several machine guns. MC DADE said he once sold DRISCOLL a light point .30 caliber machine gun.

DAVIS said again that CY ANDERSON is suppose to be down in the San Diego, California, area, sometime in the near future. DAVIS said ANDERSON had been talking about going to the Mardi Gras in New Orleans and wants DAVIS to go with him. However, DAVIS probably will not be able to as he is currently on unemployment.

Jerome

Date prepared

3/14/72

Date received

1/14/72

Received from (name or symbol number)

[SD 1155-E] Informant

Received by

SA STEVEN L. CHRISTENSEN

Method of delivery (check appropriate blocks)

in person by telephone by mail orally recording device written by Informant

If orally furnished and reduced to writing by Agent:

Date

Dictated 3/14/72 to RONNIE WILSON

Transcribed _____

Authenticated by Informant _____

Date of Report

1/14/72

Date(s) of activity

1/14/72

Brief description of activity or material

INFORMATION REGARDING SAO

File where original is located if not attached

* INDIVIDUALS DESIGNATED BY AN ASTERISK (*) ONLY ATTENDED A MEETING AND DID NOT ACTIVELY PARTICIPATE. VIOLENCE OR REVOLUTIONARY ACTIVITIES WERE NOT DISCUSSED.

Information recorded on a card index by _____ on date _____

Remarks:

1-157-2815 (SAO)

ACTION:

INDEX GENE BOZARTH to 157-2815

cc:

- ① 1-170-236A -148
- 1-157-3001 (DAVIS)
- 1-157-2933 (MC DADE)
- 1-157-3017 (HOOVER)
- 1-157-1816 (POTO)
- 1-100-14819 (GODFREY)
- 1-157-1820 (YACOPEC)
- 1-157-2931 (MAYER)
- 1-100-14301 (RUPLINGER)
- 1-157-2769 (ED ANDREWS)
- 1-157-1813 (HAUGHTON)
- 1-157-2546 (CLARK)
- 1-157-3006 (GUIRE)
- 1-157-3007 (GUIRE)
- 2-157-NEW 3095 (AL RUPP)
- 1-157-28 (NSWPP)
- 1-157-1817 (WALT HAYWARD)
- 1-157-3005 (CONDE)

2-LOS ANGELES DIVISION
(1-157-SCOTT WINCHESTER)
(1-157-NATIONAL SOCIALIST AMERICAN WORKERS PARTY)

Block Stamp

SEARCHED INDEXED
SERIALIZED FILED
MAR 15 1972
FBI - LOS ANGELES
Christensen, J.L.

170-286A-148

January 14, 1972
by JEROME

The following are San Diego, California, area,
members of the SAO who are known to me:

JERRY LYNN DAVIS

STANLEY DON MC DADE

GEORGE M. HOOVER

JAMES EVAN POTO

HOWARD BARRY GODFREY

FRANK YACOPEC

ROBERT S. MAYER

PAUL RUPLINGER

In addition, I believe that one AL RUPP, a close
personal friend of DAVIS, may also be sort of a hip pocket
member of the SAO.

Specific members and supporters of the SAO include
HOWARD FRANCIS CLARK, who has been given a membership application
form which he has not returned yet, and ED ANDREWS, who has
been contributing finances to the SAO, but says he is not
ready to become a member yet. ANDREWS talks about returning
to the State of Arkansas, in the not too distant future, and
has indicated he might be agreeable to doing some recruiting
and organizing work there for the SAO.

BETTIE HAUGHTON has been doing some of the organizational and printing work for the SAO. She has an off-set press which is located in the garage of the house belonging to WALT and EDITH GUIRE located at 4114 Massachusetts, La Mesa, California. The GUIRES are former MM sympathizers, and are close friends of BETTIE HAUGHTON.

About December 29, 1971, the GUIRES agreed to do some research work for the SAO.

In addition, DAVIS said that WALT HAYWARD wrote to him recently about the SAO offering to help in any way he can. However, he claimed he has been out of work for awhile and is short of money. Furthermore, SAM mentioned he would like to take BARRY GODFREY and pay a call to LOU CONDE to ask him for donations and other assistance for the SAO.

SAM said that SCOTT WINCHESTER, leader of the National Socialist American Workers Party, faction of the Nazi Group at Los Angeles, California, is to be in town tomorrow, January 15, 1972. Apparently the purpose of his visit will be to discuss the possibility of setting up some kind of a quasi alliance between the SAO and the NSAWP.

The name GENE BOZARTH has come to my attention as a likely source of good information regarding Left Wing activities on the San Diego State College (SDSC) campus.

BOZARTH, who is suppose to be a State College student, lives at 6979 Galewood, and has telephone number 583-8219, and a mailing address of Post Office Box 1566, San Diego, California.

When I was at DAVIS' house last night, talking about the visit of WINCHESTER to San Diego, California, AL RUPP was there, which kind of put the dampers on the discussion.

Jerome

Date prepared

3/14/72

Date received

1/17/72

Received from (name or symbol number)

[SD 1155-E] Informant

Received by

SA STEVEN L. CHRISTENSEN

Method of delivery (check appropriate blocks)

in person by telephone by mail orally recording device written by Informant

If orally furnished and reduced to writing by Agent:
Date

3/14/72

to RONNIE WILSON

Date of Report

1/17/72

Date(s) of activity

1/16/72

Dictated

Transcribed

Authenticated
by Informant

Brief description of activity or material

INFORMATION REGARDING THE S.A.O.

File where original is located if not attached

* INDIVIDUALS DESIGNATED BY AN ASTERISK (*) ONLY ATTENDED A MEETING AND DID NOT ACTIVELY PARTICIPATE. VIOLENCE OR REVOLUTIONARY ACTIVITIES WERE NOT DISCUSSED.

Information recorded on a card index by _____ on date _____

Remarks:

1-157-2815 (SAO)
cc:
① 170-286A-149
1-100-14319 (GODFREY)
1-157-3001 (DAVIS)

Block Stamp

170-286A-149

SEARCHED _____ INDEXED _____
SERIALIZED _____ FILED _____

MAR 27 1972
FBI - SAN DIEGO

Christensen

January 17, 1972
by JEROME

Last night BARRY GODFREY told that earlier in the day two San Diego, California, Police Department, detectives had come to his house questioning him about the shooting incident at the residence of Professor PETER BOHMER on January 6, 1972. GODFREY said the detectives names, SANDERS and SHIVELY, came on very strong as though GODFREY was a self-admitted member of the SAO. They asked what he knew about the shooting incident and whether the SAO had been involved. He told them he did not know anything about the shooting except when he had read the paper, and he did not elaborate on the SAO. They then asked him whether he had any 9 mm. weapons to which he replied he did not and that he did not like that caliber. Following that, they asked him if he knew anyone in the SAO who had anything to do with the incident and GODFREY said that he did not. The detectives then said the shooting incident was a very bad deal, and GODFREY agreed with them stating it was very unprofessional and that if someone had really wanted to do something to Professor BOHMER, they could have easily taken the front half of his building off.

GODFREY said the detectives were somewhat interested in his automobile, and explained to him that they had previously observed him visiting at the residence of JERRY LYNN DAVIS.

Jerome

Date prepared

3/14/72

Date received

1/18/72

Received from (name or symbol number)

[SD 1155-E] Informant

Received by

SA STEVEN L. CHRISTENSEN

Method of delivery (check appropriate blocks)

in person by telephone by mail orally recording device written by Informant

If orally furnished and reduced to writing by Agent:

Date

Dictated 3/14/72 to RONNIE WILSON

Transcribed _____

Authenticated
by Informant _____

Date of Report

1/18/72

Date(s) of activity

1/17/72

Brief description of activity or material

INFORMATION REGARDING JERRY LYNN

DAVIS and S.A.O.

File where original is located if not attached

* INDIVIDUALS DESIGNATED BY AN ASTERISK (*) ONLY ATTENDED A MEETING AND DID NOT ACTIVELY PARTICIPATE. VIOLENCE OR REVOLUTIONARY ACTIVITIES WERE NOT DISCUSSED.

Information recorded on a card index by _____ on date _____

Remarks:

1-157-2815 (SAO)

cc:

①-170-286A-150

1-157-3001 (DAVIS)

1-100-14319 (GODFREY)

[Handwritten signature]

170-286A-150
Block Stamp

SEARCHED INDEXED
SERIALIZED FILED
MAR 23 1972
FBI - SAN DIEGO

[Handwritten initials]

January 18, 1972
by JEROME

Last evening BARRY GODFREY told me that SAM DAVIS had been interviewed by the same two detectives who talked to GODFREY the day before. He said they asked SAM if he was a member of the SAO and he said he was. They then asked him if he was responsible for the shooting incident at Professor BOHMER's house or if he knew of anyone who was involved in the incident to which DAVIS replied no. He then told the detectives that if the SAO, as an organization, had wanted to do something like that, Professor BOHMER would have been leveled to the ground. They then asked DAVIS many questions about the SAO to which he answered as truthful as he was able, and particularly they asked if the SAO intended to put out more bulletins similar to the one it had prepared on Professor BOHMER. DAVIS told them that the SAO did intend to print such bulletins, which caused the detectives to ask him if the same number of bulletins would be sent out or if more or less would be sent. DAVIS said more and indicated that the next bulletin would be sent to about three hundred people; the one after that to about five hundred people and the one after that to about one thousand people. According to DAVIS, this caused the detectives to become very upset and they said they did not think sending out so many bulletins was a very good idea as

this could cause a lot of trouble for somebody.

The detectives then asked DAVIS about the weapons which he owned and indicated they were aware that he has had about forty hand guns registered to him, including several 9 mm. weapons. DAVIS apparently told them he does not presently own any 9 mm. weapons, and satisfactorily explained to them the disposition of those which he once owned.

Jerome

170-286

Date prepared

3/14/72

Date received

1/20/72

Received from (name or symbol number)

SD 1155-E Informant

Received by

SA STEVEN L. CHRISTENSEN

Method of delivery (check appropriate blocks)

in person by telephone by mail orally recording device written by Informant

If orally furnished and reduced to writing by Agent:

Date

Dictated 3/14/72 to RONNIE WILSON

Transcribed _____

Authenticated by Informant _____

Date of Report

1/20/72

Date(s) of activity

1/19/72

Brief description of activity or material

INFORMATION REGARDING RIGHT WING ACTIVISTS
AND GUN DEALERS, SAN DIEGO, CALIFORNIA
AREA.

File where original is located if not attached

* INDIVIDUALS DESIGNATED BY AN ASTERISK (*) ONLY ATTENDED A MEETING AND DID NOT ACTIVELY PARTICIPATE. VIOLENCE OR REVOLUTIONARY ACTIVITIES WERE NOT DISCUSSED.

Information recorded on a card index by _____ on date _____

Remarks:

- 1-157- (BILL GUIETTE) ✓
- cc: 170-286A-151
- 1-157-2177 (FORREST)
- 1-157-3001 (DAVIS)
- 1-157-2815 (SAO)
- 1-100-14819 (GODFREY)
- 1-157-3017 (HOOVER)
- 1-157-2832 (CAREY)
- 1-170-26 SUB

157-2177-11 } no main file
157-2815-31 }

ACTION:

Information regarding the possible possession of barrelled receivers for M-14 rifles by TOM FORREST has been discussed with SA ROBERT G. MOORE who indicated he was aware of FORREST's activities and would discuss them with ATFD.

INDEX JACK RICHARDS to SD 157-3001.
LARRY BROWN to SD 157 file on BILL GUIETTE.

With regard to information concerning DAVIS' plan to burglarize and blow up an explosives magazine, the San Diego Police Department was advised.

Block Stamp

170-286A-151

SEARCHED INDEXED FILED

FBI - SAN DIEGO

Christensen

January 20, 1972
by JEROME

I have learned that the Bulls Eye Gun Shop in El Cajon, California, has been closed as it was not making much money. BILL GUIETTE, the former manager, is now hanging around with a friend named LARRY BROWN at the Jiffy Machine Shop. Most of the gun shop inventory, including many weapons, is now located in GUIETTE's garage at his home.

TOM FORREST has a business establishment named the Tom Forrest Company located in the Midway Industrial Center on Kurtz Street just off Rosecrans. He is usually there most afternoons and evenings.

I was at FORREST's place last night and learned that he had many bi-pods from M-14 rifles, which were probably stolen. He said he got them from a Marine who had just walked in off the street with them. Furthermore, I was digging around in FORREST's back room, and found there in the neighborhood of one hundred boxes of what appeared to be barrelled M-14 actions. I opened one of the boxes sufficiently to see what was inside, and assumed that the rest of the boxes had the same thing in them. In my opinion, it is likely that these barrelled actions were supposed to have been destroyed at a place like Fort Ord, but somehow, got into FORREST's possession instead.

With regard to the shooting incident at Professor BOHMER's house, FORREST said he had been contacted by two detectives from the San Diego, California, Police Department. Apparently SAM DAVIS once had two 9 mm. pistols, and when he was interviewed by the detectives, he told them he sold one to TOM FORREST, and the other to an individual named JACK RICHARDS, a local "gun nut" type. FORREST said he guessed the detectives got in touch with him to check DAVIS' story out and verified that DAVIS did, in fact, sell him one of the two pistols. However, FORREST conveniently was unable to remember what he did with the gun after he bought it. He told me confidentially he had sold it to a Mexican in Tijuana, Baja California, Mexico.

FORREST said the detectives seemd to have been convinced that the weapons used in the BOHMER's shooting incident was a Browning High Power. They also asked FORREST if he was a member of the SAO which he denied. They then asked FORREST if he knew whether BARRY GODFREY owned or had purchased or sold any 9 mm. weapons, and what he usually bought from FORREST, when he did business with him. FORREST said he told them that GODFREY was not know to have any 9 mm. weapons and did not particularly like them, that he preferred .45 caliber pistols and .30 and that those were the only type he had purchased from FORREST. The detectives then asked FORREST whether SAM DAVIS ever came by and who with. FORREST told

him he had seen DAVIS in his shop, accompanied by CY ANDERSON and BARRY GODFREY. FORREST said he was impressed that the detectives were very excited about the SAO and he told them he had seen the SAO bulletin which was put out on BOHMER. The detectives then indicated they might contact GODFREY again and asked FORREST if he knew what shift GODFREY worked at the Fire Department.

I also saw GEORGE HOOVER yesterday. He is still up in the air about being interviewed by the Police Department over the BOHMER shooting. He said if the Police Department came to interview him, he would tell them exactly what he thought of them. (He does not think kindly of them). He said if the Federal Bureau of Investigation attempted to interview him, he would simply say that he believed the FBI to be an unconstitutional body and an agent of a foreign power and would refuse to be interviewed by the Federal Bureau of Investigation.

DAVIS claims he has obtained the keys to both the gate and the fence as well as the door to the explosives magazine of a sand and gravel company located on Mission Gorge Road. He said he also has a complete inventory of the contents of the magazine and said it appears there are enough explosives in the magazine to fill a semi-trailer truck. He said he has a plan, the basis of which is to go into the magazine at night with a truck, load up as much explosives as the truck will carry and then go out locking the door and gate behind but leaving a time delay charge behind to blow up the

magazine and its contents so no one would ever know how much, if any, of the explosives were taken.

It should be remembered that DON CAREY was suppose to have been a powder monkey at that location in the past, however, DAVIS said that JIM POTO was the one who actually came up with the keys. DAVIS did not explain how or where POTO got them.

Jerome

UNITED STATES GOVERNMENT

Memorandum

TO : SAC, SAN DIEGO (157-2931)

DATE: 3/31/72

FROM : SA STEVEN L. CHRISTENSEN

SUBJECT: ROBERT S. MAYER
EM - SAO

Informant

On this date [SD 1155-2] advised that the Subject had recently married the daughter of LEON C. SPERRY. SPERRY is prominent in the John Birch Society. In addition, MAYER purchased the residence at 2204 Montclair, San Diego, from SPERRY and is living there now with his wife.

Source said Subject formerly worked in a gas station in Mission Valley. He is now doing construction work through the local carpenter's union. Source said MAYER is believed to be driving a new Ford Falcon automobile.

It is noted that efforts to locate identifying information regarding the Subject through CLETS have been unproductive to date.

LEAD

Will review marriage records to obtain additional background information on MAYER.

Will determine nature of present employment.

Will determine vehicle he drives.

Will obtain photograph of Subject.

① 170-286A
1 - SD 157-2931
SLC/slc
(1)

Pls. Post [scribble]

170-286A-152

SEARCHED	INDEXED
SERIALIZED	FILED
APR 1 1972	
FBI - SAN DIEGO	

[Signature]



Memorandum

TO : SAC, SAN DIEGO (88-4867)

DATE: 4/12/72

FROM : SA STEVEN L. CHRISTENSEN

SUBJECT: TAYLOR MORRIS TEAFORD, aka
UFAP - MURDER, ASSAULT TO COMMIT MURDER
TOP TEN FUGITIVE

Re Sacramento airtel to the Bureau on 2/22/72.

Informant

On 3/15/72 [SD 1155-E] familiar with Minuteman and related activities in this area, was alerted to contents and requests of re: airtel. Source stated he would discretely check around and determine whether he could learn anything regarding TEAFORD.

On 4/4/72, source was recontacted at which time he advised that the Subject does not seem to be known in the San Diego area. He said he would remain alert to this matter and would immediately contact the writer if he should learn anything of value.

1 - SD 88-4867
① - SD 170-286
SLC/slc
(2)

170-286A-153

SEARCHED	INDEXED
SERIALIZED	FILED
FBI - SAN DIEGO	

Buy U.S. Savings Bonds Regularly on the Payroll Savings Plan

5/16/72

CALIFORNIA LAW ENFORCEMENT TELETYPE CODE

URGENT
CALVIN HENDELL FOX IS WHITE MALE, SIX FEET TALL, ONE HUNDRED SEVENTY
TELETYPE BLUE EYES, RESIDENCE TWO FOUR TWO SIX

TO: BUREAU AND SAC LOS ANGELES ATTN: DID
FROM: SAC, SAN DIEGO (157-3170)

CALVIN HENDELL FOX; EM DASH SAO

A SOURCE WHO HAS FURNISHED RELIABLE INFORMATION IN THE PAST
ADVISED ON MAY SIXTEENTH, NINETEEN SEVENTY TWO THAT, ONE OF THE
MORE RABID AND VIOLENT/MEMBERS OF THE SECRET ARMY ORGANIZATION
PAREN SAO END PAREN IN SAN DIEGO BOARDED A PLANE FOR WASHINGTON,
D. C. THIS DATE MUTTERING THAT HE INTENDED TO DO SOME DEMONSTRATING
HIMSELF. HE INDICATED TO ASSOCIATES THAT HE INTENDED TO RETURN IN
TEN OR ELEVEN DAYS. FOX IS AN AVID SUPPORTER OF GOVERNOR GEORGE
WALLACE, A PRESIDENTIAL CANDIDATE RECENTLY THE VICTIM OF AN
ASSASINATION ATTEMPT.

FOX IS PRESENTLY ON PROBATION FOR THREE YEARS IN LOS ANGELES,
CALIFORNIA FOR ATTEMPTING TO ATTACK A SPEAKER AT A RALLY AND FOR
ATTEMPTING TO DESTROY EQUIPMENT BEING USED IN THE RALLY, ACCORDING
TO SOURCE.

FOX OPERATES A GULF SERVICE STATION AT SECOND AND MOLLISON,
EL CAJON, CALIFORNIA. HE IS DESCRIBED BY SOURCE AS FIVE FEET TEN
OR ELEVEN INCHES TALL, SLENDER, ONE HUNDRED AND SIXTY POUNDS, DARK
HAIR SLIGHTLY BALDING, AGE ABOUT FORTY FIVE, DOES NOT WEAR
GLASSES.

① - 170-286A
EMP:EMP

8

170-286A-154

[Handwritten signature]

CALIFORNIA LAW ENFORCEMENT TELETYPE SYSTEM PAREN CLETS END PAREN
RECORDS INDICATE FOX IS WHITE MALE, SIX FEET TALL, ONE HUNDRED SEVENTY
FIVE POUNDS, BLUE EYES, BROWN HAIR, RESIDENCE TWO FOUR TWO SIX
CAPITAN AVENUE, SAN DIEGO, CALIFORNIA, NINE TWO ONE ZERO FOUR.
CALIFORNIA DRIVER'S LICENSE NUMBER IS G SIX ONE ZERO FOUR EIGHT TWO.
HE FORMERLY RESIDED AT NINE TWO FIVE DIAMOND STREET, MONROVIA, CALIFORNIA.
ANOTHER FORMER RESIDENCE IS FIVE WEST HUNTINGTON DRIVE, ARCADIA,
CALIFORNIA. WIFE BELIEVED TO BE GISELLA FOX ACCORDING TO CLETS
RECORDS.

SAO IS A PARA MILITARY RIGHT WING EXTREMIST ORGANIZATION FROM
THE SAN DIEGO AREA.

FOREGOING IS FURNISHED FOR INFORMATION IN VIEW OF SUBJECT'S
PROPENSITY FOR VIOLENCE. SAN DIEGO HAS NO INFORMATION ~~XXXXXXXXXX~~
THAT
~~XXXXXXXXXX~~ SUBJECT'S VISIT TO WASHINGTON, D.C. INVOLVES A THREAT TO
ANY GOVERNMENT OFFICIAL OR NATIONAL FIGURE.

ADMINISTRATIVE:

JOHN KEEFE, U. S. SECRET SERVICE, SAN DIEGO ADVISED BY SA EARL M.
PETERSEN AT FOUR TWENTY PM INSTANT DATE.

SOURCE WHO FURNISHED ABOVE INFORMATION IS ^{Informant} [SD ONE ONE FIVE FIVE
DASH E.]

LOS ANGELES FURNISH BUREAU, SECRET SERVICE AND SAN DIEGO AVAILABLE
BACKGROUND INFORMATION RE SUBJECT.

NO LHM BEING SUBMITTED ONE HUNDRED AND SIXTY POUNDS, BARK
PENDING.

Date prepared

5/15/72

Date received

2/8/72

Received from (name or symbol number)

[SD 1155-E] Informant

Received by

SA STEVEN L. CHRISTENSEN

Method of delivery (check appropriate blocks)

in person by telephone by mail orally recording device written by Informant

If orally furnished and reduced to writing by Agent:

Date

Dictated 5/13/72 to Dictaphone

Transcribed 5/14/72

Authenticated by Informant 4/15/72

Date of Report

2/8/72

Date(s) of activity

Current

Brief description of activity or material

Info re members and activities of SAO

File where original is located if not attached

* INDIVIDUALS DESIGNATED BY AN ASTERISK (*) ONLY ATTENDED A MEETING AND DID NOT ACTIVELY PARTICIPATE. VIOLENCE OR REVOLUTIONARY ACTIVITIES WERE NOT DISCUSSED.

Information recorded on a card index by _____ on date _____.

Remarks:

- ① - SD 170-286A - 155
- 1 - SD 157-1820 (YACOPEC)
- 1 - SD 157-3017 (HOOVER)
- 1 - SD 157-3001 (DAVIS)
- 1 - SD 100-14819 (GODFREY)
- 1 - SD 100-14301 (RUPLINGER)
- 1 - SD 100-15355 (BUSCH)
- 1 - SD 157-2815 (SAO)

- 1 - Seattle (CY ANDERSON)

INDEX: CY ANDERSON to 157-2815.

157-2815-28

of

Block Stamp

170-286A-155

SEARCHED	INDEXED
SERIALIZED	FILED
MAY 17 1972	
FBI - SAN DIEGO	

Christensen

JEROME
2/8/72

FRANK YACOPEC and GEORGE HOOVER have been getting together lately and may decide to start working together on some of their weird projects.

As I mentioned before, the Yuma Gun Show is coming up on the 25th, 26th & 27th of this month. CY ANDERSON will be down from Seattle to go to the show. He will come to San Diego first and spend a few days here selling various things that he is bringing down. SAM DAVIS and BARRY GODFREY are also going to the gun show. It is expected that EV MOORE will be there from Phoenix, and that there will be organizational meetings of the SAO during the gun show.

PAUL RUPLINGER has already put in an order for \$800 worth of the stuff which CY ANDERSON is bringing down from Seattle. This stuff is supposed to include some military-type sleeping bags, rifles, ammunition, etcetera.

The San Diego Public Library maintains a name index on all persons whose names figure prominently in the local newspapers. It appears that someone has gone through this index and systematically removed the names of all individuals with Left Wing connections. RUPLINGER was quite upset about this and said he had a friend he would check with about it.

SAM DAVIS was also by the other day and said he was looking for ten fuse-type blasting caps, but did not say what for.

JERRY LEE BUSCH has become a pain in the neck for the local people because of the trouble and commotion he has caused and because of being so untrustworthy. DAVIS and others will make efforts to get him to leave town by

making him think that the Left Wingers are out to get him.

He also indicated that the SAO is giving up to put out another special intelligence bulletin in the near future.

Jerome

Date prepared

5/15/72

Date received

2/14/72

Received from (name or symbol number)

[SD 1155-E] Informant

Received by

SA STEVEN L. CHRISTENSEN

Method of delivery (check appropriate blocks)

in person by telephone by mail orally recording device written by Informant

If orally furnished and reduced to writing by Agent:

Date

Dictated 5/13/72 to Dictaphone

Transcribed 5/14/72

Authenticated by Informant 6/15/72

Date of Report

2/14/72

Date(s) of activity

Current

Brief description of activity or material

Activities of SAO and members

File where original is located if not attached

* INDIVIDUALS DESIGNATED BY AN ASTERISK (*) ONLY ATTENDED A MEETING AND DID NOT ACTIVELY PARTICIPATE. VIOLENCE OR REVOLUTIONARY ACTIVITIES WERE NOT DISCUSSED.

Information recorded on a card index by _____ on date _____

Remarks:

- ① - SD 170-286A - 156
- 1 - SD 157-2815(SAO)
- 11- SD 157-3224(NSAWP)
- 1 - SD 157-1813(HAUGHTON)
- 1 - SD 157-1614(HAUGHTON)
- 1 - SD 157-3005(CONDE)
- 1 - SD 157-1798(MM)
- 1 - SD 157-3001(DAVIS)
- 1- SD 157-2388(SCOTT WINCHESTER)
- 2 - Los Angeles

- 2 - Phoenix

~~INDEX TO SD 170-286A-156~~

No action has been taken at this time regarding the alleged possession of weapons by two individuals at Los Angeles as their identities are not yet known and also to avoid compromising the informant.

170-286A-156
Block Stamp

SEARCHED	INDEXED
SERIALIZED	FILED
MAY 17 1972	
FBI - SAN DIEGO	

Christensen

JEROME
2/14/72

I was in contact with SAM DAVIS this morning. He told me that over last weekend, the SAO had received mail from an individual at Phoenix, Arizona, who is the area leader there of the National Socialist American Worker's Party for SCOTT WINCHESTER at Los Angeles. DAVIS said this individual was formerly a member of the Minutemen Organization but had lost contact with that group and had begun associating with the Nazi's. In his letter, this individual said he had heard of the SAO and he and his entire group were interested in joining.

DAVIS said he had also talked to BETTIE HAUGHTON over the weekend. She told DAVIS she had been contacted recently by two individuals from Covina. She described these persons as formerly trusted leaders in the Minutemen Organization under her husband, TROY. She said these persons were interested in joining the SAO. One of them is supposedly moving to the State of Oregon in the near future, and indicated he would organize for the SAO there.

She also told DAVIS that her husband, TROY, had once borrowed money from these individuals and in return had given them, as security, two 81 milimeter mortars with a number of rounds of ammunition and a case of 36 grenades. The amount of money owing on these weapons is about \$100. SAM said he might sell some of the grenades at \$10 apiece to pay off this debt. He also claimed that he can get additional rounds for the 81 milimeter mortars at \$10 apiece, but did not say where or how. We should be in contact with these individuals from Covina in the near future, and I will try then to learn more about them.

It is well known that TROY HAUGHTON had a habit of borrowing money around from among his friends. When I was last at LOU CONDE's place, I saw an I.O.U. there to him from TROY for \$500.

It is also possible that the two individuals from Covina may know the whereabouts of the Army Field Hospital which TROY HAUGHTON is supposed to have stashed.

DAVIS also indicated that the SAO may put out a poster this weekend in the form of a wanted poster showing President NIXON to be wanted for treason in connection with his trip to China.

Jerome

Date prepared

5/15/72

Date received

2/17/72

Received from (name or symbol number)

SD 1155-B Informant

Received by

SA STEVEN L. CHRISTENSEN

Method of delivery (check appropriate blocks)

in person by telephone by mail orally recording device written by Informant

If orally furnished and reduced to writing by Agent:

Date

Dictated 5/13/72 to Dictaphone

Transcribed 5/14/72

Authenticated by Informant 5/15/72

Date of Report

2/17/72

Date(s) of activity

Current

Brief description of activity or material

Info re CALVIN FOX as new member of SAO and other Right Wing activities in area

File where original is located if not attached

* INDIVIDUALS DESIGNATED BY AN ASTERISK (*) ONLY ATTENDED A MEETING AND DID NOT ACTIVELY PARTICIPATE. VIOLENCE OR REVOLUTIONARY ACTIVITIES WERE NOT DISCUSSED.

Information recorded on a card index by _____ on date _____

Remarks:

- ① - SD 170-286A - 157
- 1 - SD 157-3170(FOX)
- 1 - SD 157-2815(SAO)
- 1 - SD 157-3017(HOOVER)
- 1 - SD 100-14806(PAULA THARP)
- 1 - SD 100-15450(PETER BOHMER)

INDEX TO 157-2815: LLOYD PULLEN, TOM OSBORNE, CARL MC INTYRE, TIM HAY, LILABUCK, ~~PAULA THARP~~, ~~PAULA THARP~~, DICK DEXTRAZE.

100-1761-535PT

ef

170-286-A-157
Block Stamp

SEARCHED	INDEXED
SERIALIZED	FILED
MAY 17 1972	
FBI - SAN DIEGO	

Christensen 1 jll

JEROME
2/17/72

I learned this morning from BARRY GODFREY that he had been in contact with an individual named CALVIN FOX. FOX has just recently moved to the San Diego area from Los Angeles, and is operating a Gulf Service Station at the corner of Mollison and Broadway in El Cajon, California. FOX was supposedly a former member of the Minutemen Organization at Los Angeles and has Minutemen Serial Number A60065. The A on the serial number may mean that he was recruited by an individual named LLOYD PULLEN. FOX claims to have been married about four years ago to a girl from Yugoslavia at London, England.

FOX was recommended to GODFREY by his letter carrier, TOM OSBORNE. It appears that FOX may be the next new member of the SAO and that OSBORNE may also join some time in the future.

It has come to my attention that the Reverend CARL MC INTYRE is coming to town next Wednesday, and will speak at a rally and picket to take place in front of the main U.S. Post Office in downtown San Diego, to protest President NIXON's trip to China. This appearance on the part of MC INTYRE is being sponsored by TIM O'HAY, LILA BUCK and others of the SCOTT Memorial Baptist Church in San Diego.

GEORGE HOOVER claims that he got a telephone call from either/or both the Gunsmoke Ranch and the Fleury Ranch in Harbison Canyon, that officers from the San Diego Police Department had been there looking for him. He said he was later interviewed at his residence by these police officers, who told him they had received an anonymous telephone call informing them that HOOVER was a member of the SAO, and that he had been involved in the shooting of PAULA THARP at the residence of PETER BOHMER. HOOVER said he simply told them he was not a

member of the SAO and that he did not know anything about the shooting incident. HOOVER said he suspects that the anonymous telephone call may have been made by DICK DEXTRAZE who frequently hangs around the Fleury place in Harbison Canyon.

Jerome

Date prepared

5/15/72

Date received

2/21/72

Received from (name or symbol number)

TSD 1155-E Informant

Received by

SA STEVEN L. CHRISTENSEN

Method of delivery (check appropriate blocks)

in person by telephone by mail orally recording device written by Informant

If orally furnished and reduced to writing by Agent:

Date

Dictated 5/13/72 to Dictaphone

Transcribed 5/14/72

Authenticated by Informant 6/15/72

Date of Report

2/21/72

Date(s) of activity

Current

Brief description of activity or material

Info re activities of Secret Army Organization

File where original is located if not attached

* INDIVIDUALS DESIGNATED BY AN ASTERISK (*) ONLY ATTENDED A MEETING AND DID NOT ACTIVELY PARTICIPATE. VIOLENCE OR REVOLUTIONARY ACTIVITIES WERE NOT DISCUSSED.

Information recorded on a card index by _____ on date _____

Remarks:

- 1 - SD 170-286A-158
- 1 - SD 157-2815(SAC)
- 1 - SD 100-14819(GODFREY)
- 1 - SD 157-3017(HOOVER)
- 1 - SD 157-1813(POTO)
- 1 - SD 100-14301(RUPLINGER)
- 1 - SD 157-3001(DAVIS)
- 1 - SD 157-2831(EV MOORE)
- 1 - SD 100-14299(LYLE MANNING)

INDEX: CY ANDERSON, JESSE CLAYBURN STEVENS, ~~LYLE MANNING~~, AND ~~LYLE MANNING~~ to 157-2815.

No action has been taken at this time with regard to the 81 mm mortars, etc., inasmuch as the identities of the individuals allegedly in possession of them are not known, and to avoid compromising the informant.

170-286A-158
Block Stamp

SEARCHED <input checked="" type="checkbox"/>	INDEXED <input checked="" type="checkbox"/>
SERIALIZED <input checked="" type="checkbox"/>	FILED <input checked="" type="checkbox"/>
MAY 17 1972	
FBI - SAN DIEGO	

Christensen

JEROME
2/21/72

SAM DAVIS claims there will be a meeting tomorrow between him and BARRY GODFREY and the two individuals from Covina, California, to make the transfer of the two 81 milimeter mortars and the box of hand grenades. DAVIS said he will put up half of the money required and wants GODFREY to come up with the other \$50. The meeting will take place at a "safe" house somewhere in the area at about 2:00 in the afternoon. DAVIS will come by GODFREY's house and then they will go to make the meeting in GODFREY's truck, a white Ford Shortbed Pick-up Truck, with a small camper on the back, and with California license 99704F. After obtaining the mortars and hand grenades, DAVIS claims he will leave them at some other house he has in mind.

According to DAVIS, the SAO has elected to go ahead with printing and putting out the wanted posters on President NIXON. According to DAVIS, PAUL RUPLINGER will finance the printing which will be done by BETTIE HAUGHTON. The original plan is to contract for 10,000 copies of the posters and to have them distributed by CY ANDERSON in the Seattle, Washington area; EV MOORE, at Phoenix, Arizona; LYLE MANNING, in the State of Utah; JESSE CLAYBURN STEVENS, at Baltimore, Maryland; and of course all over the San Diego area.

Apparently, there was an article which appeared in the February 9, 1972, issue of the "Daily Aztec", which must have greatly disturbed the Left Wingers on that campus as they went around and gathered up all the copies of the paper they could find and then burned them. The burning of the papers was carried on television. If needed, I have a copy of that issue of the paper.

Jerome

Date prepared

5/15/72

Date received

2/22/72

Received from (name or symbol number)

[SD 1155-E] Informant

Received by

SA STEVEN L. CHRISTENSEN

Method of delivery (check appropriate blocks)

in person by telephone by mail orally recording device written by Informant

If orally furnished and reduced to writing by Agent:

Date

Dictated 5/13/72 to Dictaphone

Transcribed 5/14/72

Authenticated by Informant 5/15/72

Date of Report

2/22/72

Date(s) of activity

Current

Brief description of activity or material

Info re activities of JERRY LYNN DAVIS and

Secret Army Organization

File where original is located if not attached

157-2815

* INDIVIDUALS DESIGNATED BY AN ASTERISK (*) ONLY ATTENDED A MEETING AND DID NOT ACTIVELY PARTICIPATE. VIOLENCE OR REVOLUTIONARY ACTIVITIES WERE NOT DISCUSSED.

Information recorded on a card index by _____ on date _____

Remarks:

- 1 - SD 170-286A-159
- 1 - SD 157-2815(SAO)
- 1 - SD 157-3001(DAVIS)
- 1 - SD 157-3017(HOOVER)
- 1 - SD 100-15622("O.B. RAG")

INDEX: DICK DEXTRAZE to 157-2815

No action being taken regarding weapons mentioned herein as the allegations have so far failed to materialize.

Louise - put copies of SAO literature in 157-2815 only -

Block Stamp

170-286A-159

SEARCHED	INDEXED
SERIALIZED	FILED
MAY 17 1972	
FBI - SAN DIEGO	

Christensen 1 pt

JEROME
2/22/72

I understand that DAVIS received a telephone call this morning from the two individuals at Covina, California, who called to say that they would not be able to deliver the two 81 milimeter mortars and the box of hand grenades as arranged. They explained they had buried these items and were unable to locate them when they went to dig them up. They said they would try to get a metal detector and look for them again. However, it appears this operation may be postponed for an indefinite period of time.

The individual named DICK DEXTRAZE, who has been staying at the Fleury Place in Harbison Canyon, is again suspected of being an infiltrator. GEORGE HOOVER fed DEXTRAZE some phony information to the effect that local Right Wingers are maintaining a fully armed war plane at a landing field in the San Diego area. In less than a week, this information was printed in the most recent issue of the "O.B. Rag". HOOVER and others are talking about making DEXTRAZE the subject of an object lesson for the Left Wingers.

The President NIXON wanted posters are to go to press today and to be on the streets Monday. The number of copies to be printed has been reduced to 5,000. The format of the posters will be as follows:

At the top will be the words Wanted For Treason, below which will appear a photograph of the President, and underneath that a description including his last known address. At the bottom will be a suggestion that the President be impeached and be tried for treason by the proper authorities.

Attached are copies of all the recent publications and other papers of the SAO.

Jerome

Date prepared

5/16/72

Date received

2/28/72

Received from (name or symbol number)

[SD 1155-E] Informant

Received by

SA STEVEN L. CHRISTENSEN

Method of delivery (check appropriate blocks)

in person by telephone by mail orally recording device written by Informant

If orally furnished and reduced to writing by Agent:

Date

Dictated 5/15/72 to Dictaphone

Transcribed 5/15/72

Authenticated by Informant

Date of Report

2/28/72

Date(s) of activity

Current

Brief description of activity or material

Info re incident at residence of RICHARD FLEURY

File where original is located if not attached

* INDIVIDUALS DESIGNATED BY AN ASTERISK (*) ONLY ATTENDED A MEETING AND DID NOT ACTIVELY PARTICIPATE. VIOLENCE OR REVOLUTIONARY ACTIVITIES WERE NOT DISCUSSED.

Information recorded on a card index by _____ on date _____

Remarks:

- 1 - SD 170-286A - 160
- 1 - SD 157-2933 (MC DAGE)
- 1 - SD 157-3017 (HOOVER)
- 1 - SD ~~157-3017~~ 100-15355 (BUSCH)

INDEX TO 157-3017; RICHARD FLEURY, GENEVIEVE FLEURY, DICK EXTRAZE.

The San Diego Police Department and San Diego County Sheriff's Department were appropriately advised of attached information at the time received. It is noted that the Sheriff's Office was called in to investigate the altercation between FLEURY and his wife.

Block Stamp

170-286A-160

SEARCHED	INDEXED
SERIALIZED	FILED
MAY 10 1972	
FBI - SAN DIEGO	

Christensen

JEROME
2/28/72

I was talking with STAN MC DADE last week. We were discussing the situation at the residence of RICHARD and GENEVIEVE FLEURY in Harbison Canyon. According to MC DADE, RICHARD FLEURY claims that on the morning of Saturday, 2/19/72, he was walking out in his front yard when someone shot at him four times from across the canyon. Following this, his wife, already upset by his friends and activities, came unglued and hit him over the head with a lamp, following which a big fight resulted. She told him that because of his friends and activities, he was going to get her and all of their children killed. The Sheriff's Office was called and FLEURY moved out and went to stay with GEORGE HOOVER at his place. MC DADE said GENEVIEVE FLEURY later called the Sheriff's Office and them come and pick up all of her husband's guns including a .9 milimeter pistol, which they seemed very elated to find. MC DADE said HOOVER and RICHARD FLEURY are blaming the shooting incident on JERRY LEE BUSCH, and DICK DEXTRAZE, who sometimes stays at the FLEURY place. When RICHARD FLEURY went back to get his guns, he supposedly found DEXTRAZE there with his wife. MC DADE fears that HOOVER and FLEURY may attempt to take some drastic action against DEXTRAZE believing that he has been breaking the FLEURY family up.

MC DADE said that BUSCH is apparently leaving for Canada today to take a job there and may be doing so because HOOVER is so angry at him.

Jerome

Date prepared

5/16/72

Date received

3/8/72

Received from (name or symbol number)

[SD 1155-E] Informant

Received by

SA STEVEN L. CHRISTENSEN

Method of delivery (check appropriate blocks)

in person by telephone by mail orally recording device written by Informant

If orally furnished and reduced to writing by Agent:

Date

Dictated 5/14/72 to Dictaphone

Transcribed 5/15/72

Authenticated by Informant 5/15/72

Date of Report

3/8/72

Date(s) of activity

Current

Brief description of activity or material

Info re activities of SAO and members.

File where original is located if not attached

* INDIVIDUALS DESIGNATED BY AN ASTERISK (*) ONLY ATTENDED A MEETING AND DID NOT ACTIVELY PARTICIPATE. VIOLENCE OR REVOLUTIONARY ACTIVITIES WERE NOT DISCUSSED.

Information recorded on a card index by _____ on date _____

Remarks:

- ① - SD 170-286A-161
- 1 - SD 157-2815(SAO)
- 1 @ SD 157-3001(DAVIS)
- 1 - SD 157-3169(HARTLEY)
- 1 - SD 157-1816(POTOP)
- 1 - SD 157-3170(FOX)
- 1 - SD 100-14819(GODFREY)
- 1 - SD 157-3017(HOOVER)
- 1 - SD 100-15355(BUSHQ)
- 2 - SD 157-nw(GILARRUDA) @

INDEX TO ~~157-2815~~ GIL ARRUDA. TO 157-3017: RICHARD FLEURY, GENEVIEVE FLEURY.

Ch
efp.

Block Stamp

170-286A-161

SEARCHED INDEXED
SERIALIZED FILED

MAY 17 1972

FBI - SAN DIEGO

Christensen

JEROME
3/8/72

I would estimate that the SAO has received approximately \$300 to \$400 now in donations, membership application fees, and monthly dues. SAM DAVIS has been keeping this money and most of it has been spent on printing and postage costs for the SAO. DAVIS told me that DONNA LEE HARTLEY of Vista, California, recently sent \$15 into the SAO with a letter requesting all of the SAO training literature.

Apparently, the plans which JIM POTO had of going back to the Chicago, Illinois area to open up a new restaurant there for the restaurant chain he works for have not materialized. It looks as though POTO will remain in the San Diego area for the time being and will help BARRY GODFREY and DAVIS organize for the SAO. DAVIS has asked GODFREY to do a new special intelligence bulletin for the SAO on some leading figure in the New Left Movement in the San Diego area.

I have heard no new information on the situation at the FLEURY place in Harbison Canyon.

J GODFREY DAVIS claims that an individual named GIL ARRUDA may join the SAO in the near future and may allow the SAO and its members to use his place for firearms practice and training purposes. ARRUDA has about 190 acres of open land up in Wild Cat Canyon above Lakeside. DAVIS said he has been thinking about working out a method of moving up to this place to live on it.

I have been given the assignment of going out to sign up CALVIN FOX as a member of the SAO and will do so today.

Some consideration has been given to having GEORGE HOOVER come out in the open as a public recruiting officer for the SAO. HOOVER claims to have heard from

GENEVIEVE FLEURY that JERRY LEE BUSCH was supposedly stopped and arrested at the Canadian Border. BUSCH was going into Canada to work there at a radio station which is owned and operated by a friend of his.

Jerome

Date prepared

5/16/72

Date received

3/10/72

Received from (name or symbol number)

[SD 1155-E] Informant

Received by

SASTEVEN L. CHRISTENSEN

Method of delivery (check appropriate blocks)

in person by telephone by mail orally recording device written by Informant

If orally furnished and reduced to writing by Agent:

Date

Dictated 5/14/72 to Dictaphone

Transcribed 5/15/72

Authenticated by Informant 6/14/72

Date of Report

3/10/72

Date(s) of activity

Current

Brief description of activity or material

Info re CALVIN FOX

File where original is located if not attached

* INDIVIDUALS DESIGNATED BY AN ASTERISK (*) ONLY ATTENDED A MEETING AND DID NOT ACTIVELY PARTICIPATE. VIOLENCE OR REVOLUTIONARY ACTIVITIES WERE NOT DISCUSSED.

Information recorded on a card index by _____ on date _____.

Remarks:

- ① - SD 170-286A-162
- 1 - SD 157-2815(SAO)
- 1 - SD 157-3170(FOX)

It is noted that on 5/16/72, LOUIS VIENS, Area Representative, Gulf Oil Company, 3230 Jefferson, San Diego, advised that prior to becoming a Gulf dealer, FOX had been involved with a Mobil service station in the downtown San Diego area.

It is recommended that Agents be alerted and cautioned against purchasing gasoline for Bureau cars at the Subject's service station.

*Christensen -
Pref. all agents
memo - Mr
Done of*

Block Stamp

170-286-162

SEARCHED	INDEXED
SERIALIZED	FILED
MAY 19 1972	
FBI - SAN DIEGO	

Christensen

JEROME
3/10/72

CALVIN FOX was signed up today as a member of the SAO. He paid his initiation fees and first months' dues, etcetera. FOX claimed that he used to work at a mobile gas station located in the 1100 block of 11th Avenue in downtown San Diego. He said that many FBI Agents used to bring their cars there to gas up and he claimed to have taken down the license plate numbers of these cars and to have kept photocopies of the Agents' signatures and credit card numbers.

Jerome

Date prepared

5/18/72

Date received

3/11/72

Received from (name or symbol number)

[SD 1155-E] Informant

Received by

SA STEVEN L. CHRISTENSEN

Method of delivery (check appropriate blocks)

in person by telephone by mail orally recording device written by Informant

If orally furnished and reduced to writing by Agent:

Date

5/14/72

Dictaphone

Dictated _____ to _____

Transcribed 5/15/72

Authenticated by Informant 6/15/72

Date of Report

3/11/72

Date(s) of activity

Current

Brief description of activity or material

Info re activities of SAO and members.

File where original is located if not attached

* INDIVIDUALS DESIGNATED BY AN ASTERISK (*) ONLY ATTENDED A MEETING AND DID NOT ACTIVELY PARTICIPATE. VIOLENCE OR REVOLUTIONARY ACTIVITIES WERE NOT DISCUSSED.

Information recorded on a card index by _____ on date _____

Remarks:

- 1 - SD 157-2815(SAO)
- ① - SD 170-286A-163
- 1 - SD 157-2813 (HAUGHTON)
- 1 - SD 157-3001 (DAVIS)
- 1 - SD 157-3169 (HARTLEY)

Block Stamp

170-286A-163

SEARCHED _____ INDEXED _____

MAY 19 1972

FBI - SAN DIEGO

Christensen jll

JEROME
3/11/72

SAM DAVIS called me this morning and said he had been talking to BETTIE HAUGHTON. Apparently, she is about ready to leave San Diego and go up to Big Pine, California, where she will live and eventually be married. According to DAVIS, BETTIE has a miniature Minox camera, which she wanted to sell for about \$50. DAVIS said she went to a camera store and found she could only get \$30 for the Minox. She was kind of upset about this and said she would rather let the SAO have it for \$25 for the use of the organization. SAM and I will go by her place tomorrow and pick it up from her. I will also find out then exactly when she is leaving town.

SAM said he wants me to go with him tomorrow to see the new female SAO member at Vista, named DONNA LEE HARTLEY.

Jerome

Date prepared

5/16/72

Date received

3/13/72

Received from (name or symbol number)

[SD 1155-E] Informant

Received by

SA STEVEN L. CHRISTENSEN

Method of delivery (check appropriate blocks)

in person by telephone by mail orally recording device written by Informant

If orally furnished and reduced to writing by Agent:

Date

5/14/72

Dictaphone

Dictated

to

Date of Report

3/13/72

Date(s) of activity

Current

Transcribed

5/15/72

Authenticated
by Informant

6/14/72

Brief description of activity or material

Info re SAO and activities of members

File where original is located if not attached

* INDIVIDUALS DESIGNATED BY AN ASTERISK (*) ONLY ATTENDED A MEETING AND DID NOT ACTIVELY PARTICIPATE. VIOLENCE OR REVOLUTIONARY ACTIVITIES WERE NOT DISCUSSED.

Information recorded on a card index by _____ on date _____

Remarks:

- ① - SD 170-286A-164
- 1 - SD 157-2815(SAO)
- 1 - SD 157-2933(MC DADE)
- 1 - SD 157-3017(HOOVER)
- 1 - SD 157-28(NSWPP)
- 1 - SD 157-3086(KOEHL)
- 1 - SD 157-1813(HAUGHTON)
- 1 - SD 157-3001(DAVIS)
- 1 - SD 157-1816(POTO)
- 1 - SD 157-14298(FRED HAWES)
- 1 - SD 100-14819(GODFREY)
- 1 - SD 157-1614(HAUGHTON)
- 1 - SD 157-1798(MM)
- 1 - SD 157-3007(GUIRE)

INDEX TO 157-1798: VAL BOYLE, ALICE DUNN.

Info. regarding Hoover furnished to Thomas Clovis, IRS, San Diego, on 6/20/72. m

*Christensen file
Re dissemination info re
Hoover to IRS and note
on the FD 306 the contents of
the IRS ref. notified
An.*

Block Stamp

170-286A-164

SEARCHED	INDEXED
SERIALIZED	FILED
MAY 18 1972	
FBI - SAN DIEGO	

Information of

JEROME
3/13/72

I understand that STAN MC DADE and GEORGE HOOVER went to El Monte, California, last Saturday night to hear MATT KOEHL, National Commander of the NSWPP, speak. MC DADE also said he was going to attend the rally at the San Diego NSWPP Headquarters yesterday, to hear KOEHL speak.

I went to see BETTIE HAUGHTON yesterday and got the Minox camera together with four rolls of film and three gas masks. She said she is going to leave town within two weeks. SAM DAVIS was also with me and she gave SAM some keys to a garage where all of the old Minutemen camp gear is located. This stuff includes cots, stoves, medical supplies, etcetera. She also told SAM that a large quantity of explosives is supposedly buried under the house of VAL BOYLE, TROY HAUGHTON's mother.

I also understand that JIM POTO and FRED HAWES know something about this garage and have some of their stuff stored there too. HAWES used to live with BETTIE HAUGHTON and she and JIM POTO are on very good terms.

When SAM DAVIS and BARRY GODFREY were at the Yuma Gun Show weekend before last, they met with EV MOORE and discussed a few details and plans about the SAO but nothing very extensive. Apparently, there is a rumor going around that ROBERT DE PUGH, former National leader of the Minutemen Organization, may already be trying to make a comeback even though he is still in prison. This rumor is based on the fact that certain individuals who did a lot of work for him and for the Ku Klux Klan in the southwest are now highly placed in the Liberty Lobby which is now setting up survival groups and an underground organizational and communications network. It is believed that all of this activity may be part of plans for DE PUGH to come back and take over again. One of the individuals involved in these activities is ALICE DUNN, who was formerly in the organization named

American Volunteer Groups, and also worked for DE PUGH as a fund raiser.

At the suggestion of EV MOORE, the new SAO introduction letter and recruiting literature will be sent out along with a coded coupon which will have only a number rather than the recipient's name, for him to use to request more information if interested in the SAO.

MOORE, who is supposed to be a master locksmith, indicated he would write a bulletin for the SAO on how to jimmy doors and also an advanced training bulletin on lock picking and safe cracking.

BARRY GODFREY is to be the official SAO photographer and a part of his duties will include taking and editing photographs of SAO training sessions to be used for publicity.

WALT GUIRE's name was mentioned as one who might give propaganda lectures.

The SAO will also, in the near future, publish a bulletin on what members should do when they are interviewed by the law. This bulletin will include suggestions such as keeping a loaded camera by the door in order to take photographs of the interviewing officials, obtaining the name and badge number of these officials and make them wait while the appropriate agency is called to verify their identity. BETTIE HAUGHTON has said she once caught some ATFD Agents using FBI identification in their interviews. These procedures are also a harrassment tactic which may hopefully frighten away less serious minded interviewers.

GEORGE HOOVER claims he has not filed a Federal income tax return for several years. It is possible that some of the others such as DAVIS may also not have filed returns when required. HOOVER also claims to have been married twelve to fourteen years ago, but to have separated from his wife after living together for only a short while. HOOVER and DAVIS have known each other for approximately ten years.

Jerome

SAC (160-New)

5/12/72

SA EARL M. PETERSEN

UNSUB; ATTEMPT TO STOP TRAINS, 15th STREET
DEL MAR, CALIFORNIA, 5:00 PM 5/12/72.
FEDERAL TRAIN WRECK STATUTE

On this date the following information has been received:

At 9:30 am ^{InFormant} [CSSD 1325-S] advised that he has received information from sources who have furnished reliable information in the past that Anti-war demonstrators who have been demonstrating in San Diego in the past few days will go to Del Mar, California today at 5:00 pm to try to stop trains passing by the 15th Street area of the city.

At 10:00 AM ^{InFormant} [SD 1273-S] advised SA ~~XXXXXXXXXXXXXXXXXXXX~~ C. JORDAN NAYLOR that at a meeting at San Diego State College during the night of Thursday 5/11/72, a schedule of proposed anti-war activities was announced. They included a 5:00 pm meeting on 5/12/72 at 15th Street in Del Mar, California for the purpose of "stopping the train."

At 9:50 am 5/12/72, ^{InFormant} [SD 1155-E] telephonically contacted SA Steven L. CHRISTENSEN to advise that he had contacted the rumor control center at SDSC, telephone 582-4357, and had been advised that ANTI-War Demonstrators will attempt to stop trains at 15th Street, Del Mar, California at 5:00 pm 5/12/72.

Investigator GEORGE CARR, DA's Office, San Diego, telephonically contacted the writer advising that he had been in contact with SA STRICKLER, Santa Fe Railroad, Los Angeles, California, telephone 628-0111 Ext. 33652 who advised him that an SA SKOW of San Bernardino is enroute to Del Mar RR station to act as representative for the railroad in any attempt to stop the trains there today. SA STRICKLER advised that their information is that the demo. to stop the trains will start at 12:15 pm 5/12/72. He furnished train schedule as follows:

Freight train northbound 7:30 pm 5/12/72 carrying general merchandise - freight will stop at Del Mar today.

2-100 NEW	Passenger southbound XXXXXXXXXXXX	12:15
1-134-1052(.....5)	" northbound	4:30 pm
①-170-286A	" northbound	7:15 pm
1-134-1000A(.....75-3)	" southbound	9:30 pm

SEARCHED	INDEXED
SERIALIZED	FILED
MAY 15 1972	
FBI - SAN DIEGO	

There will be a small freight train leaving San Diego which will not go through Del Mar later in the day.

EMQ
(5)

170-286A-165

Date prepared

5/4/72

Date received

1/28/72

Received from (name or symbol number)

[SD 1155-E] Informant

Received by

STEVEN L. CHRISTENSEN

Method of delivery (check appropriate blocks)

in person by telephone by mail orally recording device written by Informant

If orally furnished and reduced to writing by Agent:

Date

5/4/72

CAROL HOLMES

Dictated

to

Date of Report

1/28/72

Date(s) of activity

1/28/72

Transcribed

5/30/72

Authenticated
by Informant

Brief description of activity or material

Contact of LOU CONDE by SAO for

financing

File where original is located if not attached

* INDIVIDUALS DESIGNATED BY AN ASTERISK (*) ONLY ATTENDED A MEETING AND DID NOT ACTIVELY PARTICIPATE. VIOLENCE OR REVOLUTIONARY ACTIVITIES WERE NOT DISCUSSED.

Information recorded on a card index by _____ on date _____

Remarks:

157-2815 (SAO)

~~170-286A-166~~

157-3005 (CONDE)

100-14819 (GODFREY)

157-3001 (DAVIS) ----- copies continued next page

ACTION: Index GENE BOSARTH, RICHARD FLEURY, and GENEVIEVE FLEURY to 157-2815.

Information pertaining to the RNC was appropriately disseminated when received.

With regard to information pertaining to RON ZARICK, no action has been taken inasmuch as ATFD at San Diego is already well aware of his activities and due to the fact that it does not appear specific action in this regard could be taken without exposing the source.

Block Stamp

170-286A-166

SEARCHED
SERIALIZED
MAY 31 1972
FBI - SAN DIEGO

2-0 (NEUTRALITY MATTERS)
 67-3001 (SUNDQUIST) 28, 1972
 157-2921 (ZARICK)
 157-2933 (MC DADE)
 157-2546 (CLARK)
 157-3169 (DONNA LEE HARTLEY)
 157-3017 (HOOVER)
 100-16200 (RNC)
 100-15355 (BUSCH)
 157-28 (NSWPP)
 157-201 (SMITH)

2- Los Angeles
 (1 - SCOTT WINCHESTER)
 (1 - NSWPP)
 3- Phoenix
 together (1 - SAO)
 (1 - EV MOORE)
 generator (1 - TOM PAINE)

He also agreed to send the SAO some money and said he would get support for the organization from certain other people and would put the SAO in contact with the underground Cuban Refugee Organization, Alpha 66.

Apparently COMBE is running for election to the County Board of Supervisors for the same now held by [redacted] of the FBI. He claims to be working with the [redacted] and Clement from Council. He is also supposed to be chairman of a couple of local parent associations and is highly regarded in the Republic Party for his previous campaign efforts in behalf of Governor [redacted].

COMBE claimed to DAVIS and GODFREY that [redacted] Special Agent of the FBI at San Diego named "HAROLD SUNDQUIST".

JEROME

JANUARY 28, 1972

I was told by BARRY GODFREY that he and SAM DAVIS went to see LOU CONDE this morning to ask him to help finance some of the SAO's activities. When contacted, CONDE donated a complete "Angry Thirteen" military radio set to the SAO together with all of the antennas, crystals, the hand crank, generator repair kit, etc. This is to be picked up later. He also agreed to send the SAO some money and said he would get support for the organization from certain other people and would put the SAO in contact with the underground Cuban Refugee Organization, Alpha 66.

Apparently CONDE is running for election to the County Board of Supervisors for the seat now held by WALTER SCHEIDLE. He claims he has the backing of both the La Jolla and Clairemont Town Councils. He is also supposed to be chairman of a couple of local parent associations and is highly regarded in the Republican Party for his previous campaign efforts in behalf of Governor REAGAN.

CONDE claimed to DAVIS and GODFREY that a former Special Agent of the FBI at San Diego named "BOB SUNDQUIRT",

or something similar, had owed him a considerable amount of money and that CONDE had been squeezing this individual for information even before he retired from the FBI. He said the former Agent attempted to pay him off with bad checks which came back marked "insufficient funds". CONDE said he still has these checks and showed DAVIS and GODFREY one for \$200.00. He claimed that the former Agent is now working for him as a carpenter doing boat repair work which CONDE has contracted.

CONDE also talked about the publicity he received in recent months when he offered to outfit and arm a patrol boat to accompany the American tuna fishing fleet to South American waters to keep them from being seized by Latin American Navies. In this regard, he said that many people came to see him from all over the country volunteering to go and work as crew members on such an expedition.

CONDE indicated that he possessed either an M-1 carbine which can be converted to fire fully automatic; or an M-2 carbine, which lacks certain parts in order to fire fully automatic, and asked DAVIS and GODFREY if they would help him put it together. DAVIS said he would do so.

DAVIS also offered to use the organization and facilities of the SAO to assist CONDE in his campaign. This help would include quietly planting literature for CONDE on the SAO printing presses and also to assist him in exposing problems which his opponents may have.

I was in contact yesterday with RON ZARICK. As usual, he was talking about firearms and other things. He claimed he had recently acquired an M-28 Thompson Submachine gun and an M-3 grease gun which he offered to sell to me. He said he wanted to know whether I wanted them by tonight at the latest. He is asking \$200 for the M-28, and \$125 for the M-3. This is more money than I can come up with.

He also claimed he had possession of some hand grenade fuses, some practice grenades, and some smoke grenades. He claimed these things came from a private collection of an individual living somewhere north of San Francisco who was going to bring them down if ZARICK could sell enough of them.

I also received a letter today from GENE BOSARTH, P.O. Box 15662, San Diego, California, and home address 6979 Galewood, San Diego, who has offered to furnish information

to the SAO. He is a student at San Diego State College and either has ties with or access to information about New Left activities on that campus. In his letter, he indicated he had come across some information which he thought might be of interest to the SAO.

In addition, I was talking to STAN MC DADE this morning. He told me he and HOWARD CLELAND were driving out near the Singing Hills Golf Course yesterday when they noticed they were being followed by someone in what they described as a yellow 1970 Mustang with California license 823 EIY. MC DADE said he and CLELAND took a round-a-bout route to the San Diego Fish and Game Association Range and the yellow car stayed with them all the way. MC DADE said when they got out at the range, he and CLELAND acted like they didn't know the other car had been following them. He said the occupants of the other car also pretended the same thing and came up to MC DADE and CLELAND offering to sell them some riot guns. MC DADE said he and CLELAND were suspicious of a set-up and backed out of the situation saying they would have to think about it.

I have also talked today with SAM DAVIS. He said he believed he had observed a car conducting a moving surveillance of his house. He said the license number on the car was YCD 112. He claimed he did not think the car

was a police department undercover car and thought perhaps some Left Wingers had come up with his address. SAM said this morning he received a Xerox copy of an SAO application form in the mail from one TOM PAINE (phonetic) enclosing \$5.00. The return address was a Post Office box in Tucson, Arizona. If I can, I will get the address later.

EV MOORE also wrote DAVIS and asked if there was any way he and BARRY GODFREY could make it to the Tucson gun show this weekend, as there are some people at Tucson he wants them to meet. He said he also had some good recruitment prospects for the SAO. MOORE is supposed to be a master locksmith and has offered to write a training bulletin for the SAO on lock picking. DAVIS said he would contact HOWARD CLARK who now has a private pilot's license and see if he can rent a plane with CLARK and fly over to Tucson to meet MOORE.

SAM said the SAO had also received a letter from a woman at Vista, California. He said he would give me her name and address later. In the letter, she described herself as a widow with two children and stated she wanted to do something for her country and had been thinking about joining a police or sheriff's reserve unit. However, she said she had heard about the SAO and thought that if it was

truly patriotic, she would rather join it.

SAM said the SAO had received another letter which came from "Newsweek" magazine at Los Angeles asking if the SAO would grant an interview to the magazine. In its letter, "Newsweek" said it was preparing an article dealing with Leftist groups in the San Diego area in connection with the 1972 Republican National Convention. "Newsweek" said it had run across the SAO and would like to do a column on it too. DAVIS said he thought he would like to give such an interview if the meeting could be made secure and if the SAO's Post Office Box number would appear in the article.

SAM said the SAO had also received a nice letter from the "San Diego Evening Tribune" which also wants an interview. He said in its letter, the "Tribune" said the organization appeared secretive and wondered if the SAO would allow the "Tribune" to do an article presenting the organization's views. I understand that this was mentioned to LOU CONDE when DAVIS and GODFREY went to see him and he was very happy about it. He said he knows several people very well at the "Tribune" and would talk to them and get an assurance of favorable treatment of the SAO by the paper. However, DAVIS thinks such an interview might be a little premature

as he feels that certain comments made in the interview might be too much of a slap at the San Diego Police Department.

By the way, when I was talking to STAN, he said he would like to bury some more Mauser rifles because they are cheap. He claims to have already buried some of these rifles. He said the Customs Agent who had wanted to buy a machine gun from him had been back to see him again. MC DADE said he thought the Customs Agent wanted to join the SAO. GODFREY's opinion is that the guy is a real "kook".

MC DADE said that he had been in contact with GEORGE HOOVER. He said HOOVER has been running around with RICHARD and GENEVIEVE FLEURY who live in Harbison Canyon across from the Gunsmoke Ranch. He said that JERRY LEE BUSCH has been living at the FLEURY place off and on and has set up rifle and pistol ranges there where they have been doing some target practice. HOOVER has apparently been out attempting to recruit some members for the SAO and has come up with a couple of prospects from the beach area who are long hairs. He believes these people are Right Wing-oriented but GODFREY says most likely they are attempting to infiltrate the SAO for the Left.

On Saturday, the 15th of January, SCOTT WINCHESTER came down to San Diego from Los Angeles. SAM and STAN met him somewhere and then went to STAN's house to talk. GODFREY met them there later. The discussion lasted for several hours. WINCHESTER advised he was in the process of setting up a headquarters for his organization at Los Angeles. He claimed that he wanted to work with the SAO and said he would offer the SAO the use of his facilities in Los Angeles. Later, DAVIS and GODFREY said they were cool to the idea of forming an alliance with WINCHESTER as they think he is an idiot and is lousy on his security precautions. They said they will gradually break off contact with him.

During the meeting with WINCHESTER, the participants took a break once because WINCHESTER said he wanted to go and talk with some members of the local NSWPP Unit. Because DAVIS and MC DADE are well-known to the local NSWPP, WINCHESTER and GODFREY went, each using assumed names. They talked with GERALD LEE SMITH, leader of the local NSWPP Unit. During the conversation with SMITH, WINCHESTER brought his own name up and SMITH, not knowing whom he was talking to, made many uncomplimentary remarks about WINCHESTER.

After returning to MC DADE's house, WINCHESTER talked a lot about anti-Semitism and how he believed himself

to be a perfect specimen of the Aryan race.

No one I have talked to seems to know who it was who recently passed out SAO literature at the House of Ice in San Diego.

Memorandum

TO : SAC, SAN DIEGO (157-new)

FROM : SA STEVEN L. CHRISTENSEN

SUBJECT: RICHARD MILLER
EM - SAO

DATE: 6/14/72

Bureau instructions have been received to investigate background of all members and other individuals from who members of the SAO obtain weapons ~~which~~ possession of which may represent a violation of Federal law.

Informant
On 4/26/72 [SD 1155-E] advised that approximately six months earlier he had observed JERRY LYNN DAVIS, San Diego area SAO leader, in possession of a fully automatic AR 18~~8~~ rifle in .223 caliber. DAVIS indicated he had obtained this weapon from RICHARD MILLER, telephone number 583-8078. Source said he did not know MILLER's source of the weapon, but said MILLER was rumored to have contact with the manufacturer of the rifle, Armalite Company, through a stockholder of that company, and in the past has been able to get and sell AR180 rifles (legal civilian version of the AR18) when no one else could get them. Source did not know MILLER's address.

On 4/26/72 review of the current San Diego telephone directory showed a listing for a RICHARD MILLER at 7186 Glenroy, San Diego, with the above telephone number.

On this date, review of the Polk Directory showed that RICHARD MILLER at this address is married to PATRICIA and is employed as a test engineer at Teledyne-Ryan.

In view of the foregoing it is recommended a new 157 case be opened and assigned.

2 - SD 157-new
 ① - SD 170-286A
 SLC/slc
 (3)

170-386A-167

SEARCHED	INDEXED
SERIALIZED	FILED
JUN 15 1972	
FBI - SAN DIEGO	
1 W	



Buy U.S. Savings Bonds Regularly on the Payroll Savings Plan

UNITED STATES GOVERNMENT

Memorandum

TO : SAC, SAN DIEGO (157-3000)

DATE: 6/20/72

FROM : SA STEVEN L. CHRISTENSEN

SUBJECT: ROGER DRAPEAU
EM - WHG

On 6/16/72 [SD 1155-E] advised he had heard that the Subject had moved from the San Diego area to Boston, Mass.

On 6/19/72 Miss Jean Harrison, Clerk, U. S. Postal Inspector's Office, San Diego, advised that as of 4/18/72, the Subject had entered a forwarding address of 96 Beverly, Willimawset, Mass., 01109.

LEAD

Will verify Subject's residence and employment in Massachusetts.

① - SD 170-286A
1 - SD 157-3000
SLC/slc
(2)



5010-108

Buy U.S. Savings Bonds Regularly on the Payroll Savings Plan

170-286A-168

SEARCHED	INDEXED
SERIALIZED	FILED
JUN 20 1972	
FBI - SAN DIEGO	

SAC (157-2815)(P)

6/29/72

SUPERVISOR ANDREW C. GIBSON

SECRET ARMY ORGANIZATION (SAO)
EM

Informant

On 6/29/72, [SD 1155-E] advised he had been in conversation with SAO Leader SAM DAVIS that morning and DAVIS had indicated to him that through a source in the San Diego Police Department he had learned that there is an informant in the SAO, that extensive stake outs had been conducted by the San Diego Police Department during the period following the bomb of the Guild Theater, that the Police Department had known FRANK YAKOPEC planned to bomb other targets and these targets had been staked out. That stake out officers had been told that YAKOPEC was a psychopath.

DAVIS indicated his source in the Police Department had been involved in the stake outs mentioned above. DAVIS said he was attempting to raise bail money for YAKOPEC in order to get him where he would talk to him in an effort to pin down the identity of the informant.

The above information was furnished to Detective REUBEN BRANDON, San Diego Police Department on a confidential basis on 6/29/72.

1 = 157-2815

1 = 174-531

1 - 170-286 A

ACG:gdF

(3)

170-286A-170

SEARCHED	INDEXED
SERIALIZED	FILED
JUN 30 1972	
FBI - SAN DIEGO	

1670

UNITED STATES GOVERNMENT

Memorandum

INVESTIGATION

TO : SAC , SAN DIEGO

DATE: 6/22/72

FROM : SA STEVEN L. CHRISTENSEN

TE CI SI RX E
 PC PCI PSI R (Prob)

SUBJECT: [SD 1155-E] Informant

Dates of Contact 6/20/72	
File #s on which contacted (Use Titles if File #s not available or when CI provides positive information) 157-1820 FRANK YAKOPEC, EM - SAO	
Purpose and results of contact <input type="checkbox"/> NEGATIVE <input checked="" type="checkbox"/> POSITIVE <input type="checkbox"/> STATISTIC Information herein obtained confidentially; informant's name is not to be disclosed in report or otherwise unless it has been decided definitely that he is to be a witness in a trial or hearing.	
Has informant shown any indication of emotional instability, unreliability or furnishing false information? No.	
<input checked="" type="checkbox"/> Informant certified that he has furnished all information obtained by him since last contact.	Coverage 157

PERSONAL DATA
1 - 170-235A
1 - 157-1320
1 - 174-531

Subject (3)
ep

170-286A-171
SEARCHED
SERIALIZED
JUL 1 1972
FBI
Piterson

FEDERAL BUREAU OF INVESTIGATION

Date of transcription June 22, 1972

HOWARD BARRY GODFREY, 738 Graves, El Cajon, California, furnished the following information:

On June 20, 1972, source advised telephonically that he had read of a bombing which had occurred last evening at the Guild Theater on Fifth Avenue, San Diego, in the morning "Union", on Page B-1. He said upon reading the article he immediately suspected FRANK YAKOPEC. Shortly after reading the paper, he received a telephone call from FRANK YAKOPEC who asked him if he had read the article and then hinted he had been responsible for the incident.

Subsequently source contacted YAKOPEC in person at which time he described the bombing to source as follows:

The bomb was fashioned from a 1/3 pound HPD primer with a blasting cap, six feet of safety fuse and an old cardboard type pull fuse igniter. YAKOPEC told source he approached the theater through an alley or walkway, removed the screen from an air vent and threw the device through the vent into an area under the stage of the theater. He then walked about one block away and waited for the device to detonate. He indicated that even at that distance he could feel the shock from the explosion. Source said YAKOPEC seemed to be greatly elated with the results of the blast and kept saying, "I did it! I did it!" over and over. Source said YAKOPEC, for as long as he has known him, has had a hatred for business establishments dealing in what he considers to be pornographic entertainment. He said YAKOPEC is aware of the location and the identity of the owners of most of such places in the San Diego area and that he has already "cased" approximately half of them.

He said YAKOPEC has available other explosives including one or two more 1/3 pound HPD primers, one or two one pound HPD primers, perhaps a 2 1/2 pound block of C-4 plastic explosive, and a number of blasting caps, all of which are commonly available to individuals associated with "Right Wing" activist groups in the area, and a one hundred foot roll of safety fuse which is not illegal to have.

Interviewed on 6/20/72 at El Cajon, California File # SD 157-1829
by SA STEVEN L. CHRISTENSEN /ejt Date dictated 6/22/72

This document contains neither recommendations nor conclusions of the FBI. It is the property of the FBI and is loaned to your agency; it and its contents are not to be distributed outside your agency.

UNITED STATES GOVERNMENT

SD 157-1320

Handwritten: [Illegible]

SAC [Illegible]

DATE 6/22/72

Source said he does not know of anyone else YAKOPEC may have told of his part in the bombing, with the possible exception of his wife who was visiting in Los Angeles at the time, nor did he think there was any particular reason that YAKOPEC would have informed any other person of the incident. Source said this would include other members of the SAO and that this organization was in no way a party to the bombing, which he described as a purely individual act on the part of YAKOPEC caused by his dislike for pornography.

Page 2
8 (Prob)

[Illegible handwritten notes]

[Illegible handwritten notes]

[Illegible handwritten notes]

[Illegible handwritten notes]

[Illegible handwritten notes]

[Illegible handwritten notes]

[Illegible handwritten notes]

[Illegible handwritten notes]

UNITED STATES GOVERNMENT

Memorandum

TO : SAC SAN DIEGO

DATE: 6/22/72

FROM : SA STEVEN L. CHRISTENSEN

<input type="checkbox"/> TE	<input type="checkbox"/> CI	<input type="checkbox"/> SI	<input checked="" type="checkbox"/> E
<input type="checkbox"/> PC	<input type="checkbox"/> PCI	<input type="checkbox"/> PSI	<input type="checkbox"/> E (Prob)
<input type="checkbox"/>			<input type="checkbox"/> E (Ghetto)

SUBJECT: [SD 1155-E] INFORMANT

Dates of Contact 6/21/72	
File #s on which contacted (Use Titles if File #s not available or when CI provides positive information) 157-1820 FRANK YAKOPEC, EM - SAO	
Purpose and results of contact <input type="checkbox"/> NEGATIVE <input checked="" type="checkbox"/> POSITIVE <input type="checkbox"/> STATISTIC <p style="text-align: center;">Information herein obtained confidentially; informant's name is not to be disclosed in report or otherwise unless it has been decided definitely that he is to be a witness in a trial or hearing.</p>	
Has informant shown any indication of emotional instability, unreliability or furnishing false information? <u>No.</u>	
<input checked="" type="checkbox"/> Informant certified that he has furnished all information obtained by him since last contact.	Coverage 157

PERSONAL DATA

① - 170-286A
 1 - 157-1820
 1 - 174-531

170-286A-172

SEARCHED
SERIALIZED P) S

JUL 1972

CHRISTENSEN

SLC:ejt (3)

Memorandum

Date June 22, 1972

DATE 6/22/72

HOWARD BARRY GODFREY, 738 Graves, El Cajon, California, furnished the following information:

On June 21, 1972, at approximately 3:30 PM, source advised he had talked with FRANK YAKOPEC during the preceding two hours. He said YAKOPEC informed him that the Guild Theater had not been his original target on the evening of June 19, 1972. He said he first went to a location known as "Chuck's Bookstore" in downtown San Diego, carrying the bomb in the pocket of a "Pendleton" jacket which he had slung over his shoulder. He said as he was entering the bookstore he began to pull the fuse lighter on the bomb when he was stopped by a San Diego Police Officer, who showed him his badge, telling him he could not come in as the place was being closed down as the result of a raid.

YAKOPEC then indicated he was contemplating doing another bombing within the next few nights with the following targets listed in order of preference:

CLASSIFIED
 CONFIDENTIAL
 STATISTIC

- The In Crowd on Cuyamaca Road in Santee;
- The Academy Theater on University in San Diego;
- The Pussycat Theater on 4th Avenue in San Diego;
- The Bedroom on University in San Diego.

Source said YAKOPEC has a white Ford Falcon station wagon, about 1963, with license RGC 744, and a 1956 green Chevrolet pickup, license unknown.

Do not serialize this FD 302.
 SA CHRISTENSEN resigned 7/6/72
 before signing attached.

On 6/21/72 at El Cajon

by SA STEVEN L. CHRISTEN

This document contains neither recommendations nor conclusions of the FBI. It and its contents are not to be distributed outside your agency.

UNITED STATES GOVERNMENT

Memorandum

TO : SAC, SAN DIEGO (157-1820)

DATE: 6/20/72

FROM : SA STEVEN L. CHRISTENSEN

SUBJECT: FRANK YAKOPEC
EM - SAO

Informant

On this date [SD 1155-E] advised telephonically that he had read of a bombing which had occurred last evening at the Guild Theater on Fifth Ave., San Diego, in the morning "Union", on page B-1. He said upon reading the article he immediately suspected the Subject. Shortly after reading the paper, he received a telephone call from the Subject who asked him if he had read the article and then hinted he had been responsible for the incident.

Subsequently source contacted YAKOPEC in person at which time he described the bombing to source as follows:

The bomb was fashioned from a 1/3 pound HPD primer with a blasting cap, six feet of safety fuse and an old cardboard type pull fuse igniter. YAKOPEC told source he approached the theater through an alley or walkway, removed the screen from an air vent and threw the device through the vent into an area under the stage of the theater. He then walked about one block away and waited for the device to detonate. He indicated that even at that distance he could feel the shock from the explosion. Source said YAKOPEC seemed to be greatly elated with the results of the blast and kept saying, "I didit! I did it!" over and over. Source said YAKOPEC, for as long as he has known him, has had a hatred for business establishments dealing in what he considers to be pornographic entertainment. He said YAKOPEC is aware of the location and the identity of the owners of most of ~~the~~ such ~~&~~ places in the San Diego area and that he has already "cased" approximately half of them.

He said YAKOPEC has available other explosives including one or two more 1/3 pound HPD primers, one or two one pound HPD primers, perhaps a 2 1/2 pound block of C-4 plastic explosive, and a number of blasting caps, all of which are commonly available to individuals associated with "Right Wing" activist groups in the area, and a one hundred foot roll of safety fuse which is not illegal to have.

Source said he does not know of anyone else YAKOPEC

170-2567A-173



- 1 - SD 170-286A
 - 1 - SD 157-1820
 - 1 - SD 174-531
- SLC/slc
3)

SEARCHED	INDEXED
SERIALIZED	FILED
JUN 22 1972	
FBI - SAN DIEGO	

Buy U.S. Savings Bonds Regularly on the Payroll Savings Plan

may have told of his part in the bombing, with the possible exception of his wife who was visiting in Los Angeles at the time, nor did he think there was any particular reason that YAKOPEC would have informed any other person of the incident. Source said this would include other members of the SAO and that this organization was in no way a party to the bombing, which he described as a purely individual act on the part of the Subject caused by his dislike for pornography.

UNITED STATES GOVERNMENT

Memorandum

TO : SAC, SAN DIEGO (157-1820)

DATE: 6/21/72

FROM : SA STEVEN L. CHRISTENSEN

SUBJECT: FRANK YAKOPEC
EM - SAO

On this ~~xxxx~~ date, at approximately 3:30 pm, source advised he had talked with the Subject during the preceding two hours. He said YAKOPEC informed him that the Guild Theater had not been his original target on the evening of 6/19/72. He said he first went to a location known as "Chuck's Bookstore" in downtown San Diego, carrying the bomb in the pocket of a ~~X~~"Pendleton" jacket which he had slung over his shoulder. He said as he was entering the bookstore he began to pull the fuse lighter on the bomb when he was stopped by a San Diego Police Officer, who showed him his badge, ~~xxxxxx~~ telling him he could not come in as the place was being closed down as the result of a raid.

YAKOPEC then indicated he was contemplating doing another bombing within the next few nights with the following targets listed in ~~xxxxxxx~~ order of preference:

The In Crowd on Cuyamaca Road in Santee.

The Academy Theater on University in San Diego.

The Pussycat Theater on 4th. in San Diego.

The Bedroom on University in San Diego.

Source advised he would immediately notify writer of any additional developments.

- 1 - SD 170-286A
- 1 - SD 157-1820
- 1 - SD 174-531
- SLC/slc
- (3)

Source said Yakopec has a white Ford Falcon Station Wagon about 1963, with license RGC 1744, and a 1956 green Chevy pickup, license unknown.

SEARCHED	INDEXED
SERIALIZED	FILED
JUN 22 1972	
FBI - SAN DIEGO	



Buy U.S. Savings Bonds Regularly on the Payroll Savings Plan

157-286A-174

FEDERAL BUREAU OF INVESTIGATION
UNITED STATES GOVERNMENT

Memorandum

Date July 6, 1972

Howard B. Godfrey, 738 Graves, El Cajon, California, made available the following items which he received from JERRY LYNN DAVIS:

- 100 foot roll of time fuze
- 4 1/4 time fuze ignitors
- 4 1/2 pound blocks of TNT (military type)

PC PCI PCSI PE (P ab)
E (Chotto)

The above mentioned items were obtained from DAVIS in about November, 1971.

JERRY LYNN DAVIS, SA - SAC

Purpose and results of contact

- NEGATIVE
- POSITIVE
- STATISTIC

Information contained in the attached SD 302 was obtained confidentially. Informant's name should not be disclosed in any report unless authorized in writing by the informant.

Items mentioned in attached SD 302 were used by informant to describe Ruben Brenden as of this date for possible prosecution of JERRY LYNN DAVIS.

Source has testified in court and given affidavits under oath on 7/21/72 and in case file associated with his testimony. Informant was arrested on about 7/21/72. SDPB has agreed to protect informant.

Has been interviewed and interviewed by [redacted]

On 6/30/72 at El Cajon, California File # SD 157-3001

by SA EARL M. PETERSEN Date dictated 7/6/72

UNITED STATES GOVERNMENT

Memorandum

TO : SAC (170-286A)

DATE: 7/12/72

FROM : SA EARL M. PETERSEN

SUBJECT: [SD 1155-E] *Informant*

On June 29, 1972, during a meeting between the SDPD, the source and the writer, a discussion was had concerning the possibility of conducting a search of the source's home to give him further protection in connection with information he was furnishing regarding members of the Secret Army Organization. In connection with this discussion, source was asked if he had anything in his home that would make it necessary for the police department to arrest him if his home was searched. He stated that he did have certain items he would like to get rid of before the search. He requested that the writer take the items from him.

On June 30, 1972 he made available the following items:

- 100 feet of time fuze obtained from JERRY LYNN DAVIS 11/71
- 4 1/2 lb blocks of TNT (military type) " " " "
- 44 fuze igniters " " " "

The above items were turned over to Detective Reuben Brandon, San Diego Police Department on 7/12/72 for possible evidentiary use in the arrest of JERRY LYNN DAVIS. FD 302 concerning these items has been prepared.

Other explosive items received are:

- 1 CS Handgrenade (military type) source of item not recalled
- 5 Mine fuze, practice obtained from Bill Clay about 1969.
- 1 Hand grenade fuze - deactivated

INFORMANT

The above mentioned items are stored at the 70th Ord. Det., bunker, Fort Rosecrans, California. [SD 1155-E] has advised that these items can be destroyed and a tickler has been set to advise the 70th Ord. Det - Lt. Barnett on 7/24/72 that the items can be destroyed. This will allow time to determine whether the items should be disposed of in any other manner.

- ① - 170-286A
- 1 - 157-3001 (JERRY LYNN DAVIS)
- 1 - ~~257~~ 174-531 (Yakopec - Guild Theatre Bomb)
- 1 - 100-14293 (William Clay)
- 1 - 157-3017 (Hoover)

EMP:emp

(5)

170-286A-177

SEARCHED	INDEXED
SERIALIZED	FILED
JUL 20 1972	
FBI - SAN DIEGO	

h



The following additional items were obtained and are stored in the firearms vault:

1 - 50 caliber machine gun completely disassembled with barrel cut into two pieces with welding torch. Only about ten inches of the barrel, base section, is with the gun.

Informant would like this gun returned to him if he can obtain authority to own it legally. The gun came off a wrecked World War II airplane that was found in the desert.

One silencer

The silencer was obtained from a garage and was one of a box of about 40. The others were sold in Mexico by gun dealer TOM FORREST. This silencer can be forwarded to the Bureau firearms section.

One sawed off shotgun barrel and stock.

This gun was obtained from GEORGE HOOVER about two months ago. He obtained it from an unidentified individual who got it from his son who intended to use it in a burglary. This weapon can be destroyed.

Two rifle grenade launchers

These were sent to source by one LONNIE LAMBERT, Pandora, Texas. Source would like these returned to him if he leaves the state after testimony as he says these can be legally owned outside California.

(TOM FOREST and LONNIE LAMBERT indexed in 157-3001)

Date prepared

5/10/72

Date received

1/31/72

Received from (name or symbol number)

[SD 1155-E] Informant

Received by

SA STEVEN L. CHRISTENSEN

Method of delivery (check appropriate blocks)

in person by telephone by mail orally recording device written by Informant

If orally furnished and reduced to writing by Agent:

Date

Dictated 5/10/72 to LINDA ELEGINO

Transcribed

Authenticated by Informant

[Signature]

Date of Report

1/31/72

Date(s) of activity

1/30/72

Brief description of activity or material

Info re individuals living at FLEURY residence, Harbison Canyon

File where originals located if not attached

* INDIVIDUALS DESIGNATED BY AN ASTERISK (*) ONLY ATTENDED A MEETING AND DID NOT ACTIVELY PARTICIPATE. VIOLENCE OR REVOLUTIONARY ACTIVITIES WERE NOT DISCUSSED.

Information recorded on a card index by _____ on date _____

Remarks:

157-2815
170-286A-178
157-3017
100-15355

~~INDEX~~: RICHARD FLEURY - 157-3290
GENEVIEVE FLEURY - 157-3289
INDEX - DICK DEXTRAND
to 157-2815

Inf

Block Stamp

170-286A-178

SEARCHED	INDEXED
SERIALIZED	FILED
AUG - 2 1972	
FBI - SAN DIEGO	

[Signature]

JANUARY 31, 1972

BY JEROME

I was talking yesterday with GEORGE HOOVER. He has been spending a great deal of time at the residence of RICHARD and GENEVIEVE FLEURY in Harbison Canyon across the road from the Gunsmoke Ranch.

JERRY LEE BUSCH has also been spending a lot of time there and lives with the FLEURYs part time.

Another individual who also has been spending a considerable amount of time with the FLEURYs is a person whose name is DICK DEXTER or DEXTRAND. DEXTER is a member of the Swallows Nudist Camp which is also located across Harbison Canyon Road from the FLEURYs. DEXTER has apparently been trying to work a way into some of the Right Wing activities which other people at the FLEURYs are involved in and is suspected of being an infiltrator, mostly because of the fact he lives in Ocean Beach.

Jerome 8/2/72

Date prepared

5/10/72

Date received

2/2/72

Received from (name or symbol number)

[SD 1155-E] Informant

Received by

SA STEVEN L. CHRISTENSEN

Method of delivery (check appropriate blocks)

in person by telephone by mail orally recording device written by Informant

If orally furnished and reduced to writing by Agent:

Date

Dictated 5/10/72 to LINDA ELEGINO

Date of Report

2/2/72

Transcribed _____

Authenticated by Informant 8/2/72 gp

Date(s) of activity

2/1/72

Brief description of activity or material

CONTACT WITH GENE BOSARTH. VIGILANTE

MEETING AT LAKESIDE. EXPECTED VISIT OF

CY ANDERSON TO SAN DIEGO.

File where original is located if not attached

* INDIVIDUALS DESIGNATED BY AN ASTERISK (*) ONLY ATTENDED A MEETING AND DID NOT ACTIVELY PARTICIPATE. VIOLENCE OR REVOLUTIONARY ACTIVITIES WERE NOT DISCUSSED.

Information recorded on a card index by _____ on date _____

Remarks:

~~157-2815~~

~~170-286A-179~~

157-2933

100-15450

157-3001

1 - Seattle

(157-CY ANDERSON)

INDEX: ⁰ GENE BOSARTH to
157-2815

Information pertaining to the
Republican National Convention
was appropriately handled at
the time it was received.

Block Stamp

170-286A-179

SEARCHED	INDEXED
SERIALIZED	FILED
AUG - 2 1972	
FBI - SAN DIEGO	

Platter 18

FEBRUARY 2, 1972

BY JEROME

Yesterday, I accompanied STAN MC DADE to keep an appointment with GENE BOSARTH, the San Diego State College student who has indicated a willingness to furnish information about New Left oriented activities at San Diego State College to the SAO. BOSARTH claimed to have written letters to Governor REAGAN regarding the PETER BOHMER situation at State College requesting that some action be taken against BOHMER. MC DADE backed off a little when BOSARTH mentioned he had been contacted by the local office of the California Bureau of Criminal Investigation and Identification and even went so far as to suggest that we might do the same thing.

Later in the day, I learned from both MC DADE and SAM DAVIS that there was a type of vigilante meeting in Lakeside several days ago of local individuals and groups. It appears this meeting was held to discuss and plan out actions to be taken to keep hippies and other undesirable individuals out of the Lakeside area during the Republican National Convention in San Diego this summer.

It was brought to my attention that the semi-annual Yuma Gun Show will be held on the 25th, 26th, and 27th of February. I was told that CY ANDERSON will be coming down from Seattle to attend this gun show and will come to San Diego several days in advance to take care of some business here.

Jerome 8/2/72

Date prepared

5/10/72

Date received
2/4/72

Received from (name or symbol number)
[SD 1155-E] Informant

Received by
SA STEVEN L. CHRISTENSEN

Method of delivery (check appropriate blocks)
 in person by telephone by mail orally recording device written by Informant

If orally furnished and reduced to writing by Agent:
Date
Dictated 5/10/72 to LINDA ELEGINO
Transcribed _____
Authenticated by Informant 8/2/72

Date of Report
2/4/72

Date(s) of activity
2/3/72

Brief description of activity or material
NSWPP meeting at San Diego. Info re
MICKEY BURTON WAKEFIELD

File where original is located if not attached

* INDIVIDUALS DESIGNATED BY AN ASTERISK (*) ONLY ATTENDED A MEETING AND DID NOT ACTIVELY PARTICIPATE. VIOLENCE OR REVOLUTIONARY ACTIVITIES WERE NOT DISCUSSED.
 Information recorded on a card index by _____ on date _____

Remarks:
157-28
170-286A - 180
100-14301
157-338 (VICTOR WALTON)
157-2610 (MICKEY BURTON WAKEFIELD)
157-3017
2 - Los Angeles

ER

INDEX:
O "Captain K." to 157-28

Block Stamp
170-286A-180
SEARCHED [] INDEXED []
SERIALIZED [] FILED []
AUG - 2 1972
FBI - SAN DIEGO
Peter []

FEBRUARY 4, 1972

BY JEROME

PAUL RUPLINGER told me yesterday he was at an NSWPP meeting last Wednesday night at the San Diego unit headquarters. He said about 20 people were in attendance and had come to hear a speaker from Los Angeles, known as "Captain K" tell about recent confrontations by the NSWPP and the Jewish Defense League at Los Angeles. He said VIC WALTON was one of those people he recognized as being in attendance at this meeting.

I was also told yesterday by GEORGE HOOVER that an NSWPP member named WAKEFIELD had been booted out of the organization for engaging in unauthorized activities such as throwing bricks through the windows of various New Left establishments.

Jerome

8/2/72

SAC (157-3138) (P)

9/7/72

SA EARL M. PETERSEN

VICTOR WALTON
EM - NSWPP

On 9/6/72, HOWARD BARRY GODFREY, ^{Informant} [formerly SD 1155-E,] advised that subject has never been a member or associated with the Secret Army Organization in any way known to him.

0 - 170-286A
EMP:emp

(3)

170-286A-195
~~157-3138-54~~

SEARCHED	INDEXED
SERIALIZED	FILED <i>KAB</i>
SEP 7 1972	
FBI-SAN DIEGO	
	<i>W</i>

SAC (157-2305)(P)

9/7/72

SA EARL M. PETERSEN

CHARLES WILLIAM CLAY, Jr.
EM - MINUTEMEN

On 9/6/72, HOWARD BARRY GODFREY, ^{Informant} [formerly SD 1155-E.] advised that subject has married again but he does not know the name of his wife.

Clay carries an M-2 carbine behind the back seat of his truck. He had a Beretta .22 cal. pistol with silencer two months ago. He allegedly purchased this weapon from ROGER WILLIS at the Gunsmoke Ranch.

Detective RUBIEN BRANDON, SDPD advised.

CLAY SHOULD BE CONSIDERED ARMED AND DANGEROUS

① 170-286A

EMP:emp

(3)

170-286A-196

SEARCHED	INDEXED
SERIALIZED	FILED
SEP 7 1972	
FBI-SAN DIEGO	

W

SAC (157-28)(P)

9/7/72

SA EARL M. PETERSEN

NSWPP
EM

On 8/28/72, HOWARD BARRY GODFREY, ^{Informant} [formerly SD 1155-E,] was asked how to become a member of subject group. He replied that the best way would be to attend one of the white power rallies, act enthusiastic, talk to people, act very impressed with GERALD LEE SMITH. If possible meet and talk to SMITH and tell him what a great job he is doing and be very impressed with him. SMITH goes for this.

① - 170-286A
EMP:emp
(3)

170-286A-197

170-286A-197

SEARCHED	INDEXED
SERIALIZED/1-2	FILED
SEP 7 1972	
FBI-SAN DIEGO	

102

Memorandum

TO : SAC (157-3228)(P)

DATE: 9/20/72

FROM : SA EARL M. PETERSEN

SUBJECT: PAUL ERWIN RUPLINGER
EM

Informant

On 9/12/72, HOWARD BARRY GODFREY, [formerly SD 1155-E,] advised that he had been contacted by relatives in Hawaii who advised him that subject was recently in Hawaii and had contacted a mutual friend of his. GODFREY speculated that possibly subject might be attempting to determine where he is presently living as there have been rumors that he was living in Hawaii.

On 9/19/72, Godfrey advised that PAUL RUPLINGER and his son PETER RUPLINGER will testify for the defense in the trial of WILLIAM FRANCIS YAKOPEC not in progress in San Diego County Superior Court.

In view of the new rules concerning inclusion of subjects in the ADEX, this file should be carefully reviewed and if subject does not qualify, the file should be closed.

EMP:emp ① - 170-286A
(2)

170-286A-198

SEARCHED	INDEXED
SERIALIZED	FILED
SEP 20 1972	
for [unclear] [signature]	



5010-108

Buy U.S. Savings Bonds Regularly on the Payroll Savings Plan

SAC (157-2305) (P)

9/7/72

SA EARL M. PETERSEN

CHARLES WILLIAM CLAY, Jr.
EM - MINUTEMEN

On 9/6/72, HOWARD BARRY GODFREY, ^{Is. For want} [formerly SD 1155-E.] advised that subject has married again but he does not know the name of his wife.

Clay carries an M-2 carbine behind the back seat of his truck. He had a Beretta .22 cal. pistol with silencer two months ago. He allegedly purchased this weapon from ROGER WILLIS at the Gunsmoke Ranch.

Detective RUBIEN BRANDON, SDPD advised.

CLAY SHOULD BE CONSIDERED ARMED AND DANGEROUS

① - 170-286A
EMP:emp

(3)

170-286A-199

~~157-2305-32~~

SEARCHED	INDEXED
SERIALIZED	FILED
SEP 7 1972	
FBI-SAN DIEGO	

W

SAC (157-1816)(P)

9/20/72

SA EARL M. PETERSEN

JAMEL EVAN POTO, aka
EM - SAO

On 9/6/72, HOWARD BARRY GODFREY, [formerly SD 1155-E.] advised that subject is an SAO member who helped JERRY LYNN DAVIS stash some weapons at Cuyamaca. He is in Davis's group in the SAO and is the type that might try to revenge the arrest of DAVIS.

POTO is occasionally armed and should be considered dangerous.

CONSIDER ARMED AND DANGEROUS

EMP:emp
(3)

① - 170-286A
1 - 157-3001 (DAVIS)

170-286A-200

SEARCHED	INDEXED
SERIALIZED	FILED
SEP 21 1972	
FBI-SAN DIEGO	

102

Memorandum

TO : SAC (157-1816) (P)

DATE: 9/20/72

FROM : SA EARL M. PETERSEN

SUBJECT: JAMES EVAN POTO, aka
EM - SAO

On 9/6/72, HOWARD BARRY GODFREY, ^{Informant} [formerly SD 1155-E] advised that subject is an SAO member who helped JERRY LYNN DAVIS stash some weapons at Cuyamaca. He is in Davis's group in the SAO and is the type that might try to revenge the arrest of DAVIS.

POTO is occasionally armed and should be considered dangerous

CONSIDER ARMED AND DANGEROUS

EMP:emp

(3)
of

- 1 - 170-286A
- 1 - 157-3001 (DAVIS)

170-2864-206

SEARCHED	INDEXED
SERIALIZED	FILED
OCT 5 1972	
FBI-SAN DIEGO	



5010-108

Buy U.S. Savings Bonds Regularly on the Payroll Savings Plan

SAC 157-2769)(P)

9/7/72

SA EARL M. PETERSEN

EDWARD ANDREWS
EM -

On 9/1/72, HOWARD BARRY GODFREY, ^{INFORMANT} [formerly SD 1155-E,] advised that he has not seen subject for some time and believes that he is now in Arkansas. He does not know if his middle initial is S.

ANDREWS is about 67 years old, is retired, slender, 145 pounds, 5' 8"-9" tall..

① - 170-286A

EMP:emp
(3)

170-286A-207

157-2769-2

SEARCHED	INDEXED
SERIALIZED	FILED
SEP 7 1972	
FBI-SAN DIEGO	

1 A

SAC (157-2769)(P)

10/10/72

SA EARL M. PETERSEN

CHANGED

EDWARD SPENCER ANDREWS, JR.

EM - MM * SAO

INFORMANT

On October 10, 1972, HOWARD BARRY GODFREY, [formerly SD 1155-B] looked at driver's license number H129296 for EDWARD SPENCER ANDREWS, Jr., 1809 Calla St., Imperial Beach, California 92032 and stated that this license contains a photograph of EDWARD ANDREWS who GODFREY had previously furnished information on. He is the ANDREWS, GODFREY said had gone to Arkansas.

GODFREY stated that the photograph contained on the driver's license is a good likeness of EDWARD ANDREWS.

①-170-286A

EMP:emp

(3)

g

710-286A-208

SEARCHED	INDEXED
SERIALIZED	FILED
OCT 11 1972	
FBI-SAN DIEGO	

10

SAC (157-3143) (P)

9/7/72

SA EARL M. PETERSEN

CHRIS SKINNER

INFORMATION

On 9/6/72, HOWARD BARRY GODFREY, [formerly SD 1155-E] advised that he has no new information re subject.

(Information furnished 7/31/72 is in 157-3143-3 no cpy to 170-286A)

① - 170-286A

EMP:emp

(3)

9

170-286A-210

~~157-3143-31~~

SEARCHED	INDEXED
SERIALIZED	FILED
SEP 7 1972	
FBI-SAN DIEGO	

12

SAC (157-2815) (P)

11/15/72

SA EARL H. PETERSEN

SECRET ARMY ORGANIZATION

EM

On 11/14/72, HOWARD BARRY GODFREY, ^{INFORMANT} [Formerly SD 1155-E,] advised that on about 11/12/72, RICHARD FLEURY had severely beaten his wife GENEVIEVE. She was so severely injured that her cheek bone was pushed up into her eye and her nose was broken in two places. She was taken to the hospital and surgery was necessary, including going into the top of her head to correct nerve damage.

Source stated that Mrs. FLEURY has been fooling around with GEORGE MITCHELL HOOVER and has been visiting him in jail on a weekly basis. HOOVER had requested that she bring him a map of Mexico. Source speculated that Mrs FLEURY and HOOVER might intend to flee to Mexico if he is ever released on bond. Source stated that it is his understanding that the SDCS¹ intends to arrest FLEURY on charges of felonious assault.

- 1 - 157-3017 (Hoover)
- 1 - 157-3289 (Genevieve Fleury)
- 1 - 157-3290 (Richard Fleury)
- ① - 170-286A

EMP:emp

(5)

170-286A-212

SEARCHED	INDEXED
SERIALIZED	FILED
NOV 16 1972	
FBI - SAN DIEGO	

11

SAC (157-3282)(P)

9/7/72

SA EARL M. PETERSEN

RICHARD MILLER
EM -

On 9/1/72, HOWARD BARRY GODFREY, ^{INFORMANT} [formerly SD 1155-E,] advised that subject is not affiliated with the Secret Army Organization in any way.

Subject was a friend of JERRY LYNN DAVIS who was a leader in the SAO.

① - 170-286A

EMP:emp

(B)

g

170-286A-218

~~157-3282-3~~

SEARCHED	INDEXED
SERIALIZED 29	FILED 11-7-72
SEP 7 1972	
FBI-SAN DIEGO	

g

Date prepared

1/15/73

Date received

1/17/73

Received from (name or symbol number)

FN FORMHKT
[SD2157 - E (Prob)]

Received by

Earl M. Belcher

Method of delivery (check appropriate blocks)

in person by telephone by mail orally recording device written by Informant

If orally furnished and reduced to writing by Agent:

Date

Date of Report

1/9/73

Dictated _____ to _____

Date(s) of activity

Transcribed _____

1/4/73

Authenticated by Informant 1/9/73

1/7/73

Brief description of activity or material

G. Smith Speech SDSC
~~Radio program re SAO & FBI~~

File where original is located if not attached

170-572A

* INDIVIDUALS DESIGNATED BY AN ASTERISK (*) ONLY ATTENDED A MEETING AND DID NOT ACTIVELY PARTICIPATE. VIOLENCE OR REVOLUTIONARY ACTIVITIES WERE NOT DISCUSSED.

Information recorded on a card index by _____ on date _____

Remarks:

1-170-572A-44
1-157-201 (Gerald Smith)
1-157-28 (NSWOB)
1-157-2815 (SAO)
① 170-286A
EMB: g
(5)

A

Block Stamp

170-286A-22

SEARCHED	INDEXED
SERIALIZED	FILED
JAN 17 1973	
FBI - SAN DIEGO	

1/17

[by Sandman]

Would Tend To Identify Informant

January 9, 1973

SUBJECT: Activities of Gerald L. Smith.

On Thursday night, January 4, 1973 Gerald Smith spoke to an evening class at San Diego State College. He does not remember the name of the professor in charge of the class but says he teaches advertising and public relations classes. Knowing what I do about San Diego State College, this means that the class is probably held in the Business Administration and Mathematics Building, one of the newest structures on campus. Gerald also stated that the professor had dark curly hair and sported a beard. The topic of the speech was the organizational structure of the National Socialist White Peoples Party. Gerald states that he was well received by the class and that there was no harrassment whatsoever. In fact, an invitation has been extended to Joseph Tommasi via Smith to make a similar appearance before the same class.

On Sunday, January 7, 1973 Gene Cubbison of the Independent Newspaper made a two-hour broadcast over radio station KSDO-San Diego. The broadcast included discussions of the Secret Army Organization, the FBI, Howard Barry Godfrey and Gerald L. Smith. Ray Wilson notified Smith that the program was in progress but Smith heard only about the last half hour of it. In this broadcast, Cubbison was highly critical of the SAO and FBI. Cubbison said that Peter Bohmer was being unjustly persecuted by the authorities. He criticized the FBI for not cracking down on the SAO long before it did. He challenged Barry Godfrey to call in and defend his position. A similar challenge was also issued to Gerald Smith but Godfrey seemed to be the one they really tried to bait. This program lasted from 9:30 to 11:30 a.m. During the program, at least one person did call in and this person was extremely critical of Smith. Smith believes this broadcast is merely an attempt on Cubbison's part to sell more newspapers and to dredge up old right-wing bogie men for the Marxists to throw rocks at.

Cubbison was also quite sarcastic toward Judge Froelich. He flatly stated that the reason the judge delayed the sentencing of Bohmer was because he was afraid to sentence him. He felt that the presence of the large leftist crowd in the court room intimidated Judge Froelich. Gerald Smith also feels this way about it.

That's about all for now. Will be in touch when more develops.

Sincerely,

W-011 Tend To Identify Informant [Sandman 1-9-73]

FEDERAL BUREAU OF INVESTIGATION

He stated that he is acquainted with Gene [redacted] 1276 Claretta Place, Colorado, California. Date 11/27/72

PAUL ERWIN RUFLENGER was interviewed at his home at 4567 Massachusetts Street, San Diego, California. He was advised of the identity of the interviewing agents and the purpose of the interview. He furnished the following information:

He denied ever having been a member of the Secret Army Organization (SAO) but has known HOWARD GODFREY for four or five years. He said he was surprised when he learned that GODFREY had been an informant for the FBI for the entire period that he has known him. He once met JERRY LYNN DAVIS through GODFREY. DAVIS was introduced to him as "SAM." He was aware that GODFREY and SAM were involved with the SAO. He denied knowing SY ANDERSON of Seattle, Washington or that he was involved in furnishing guns, ammunition and explosives to SAO members.

RUFLENGER has from time to time given sums of money to GODFREY for use in financing bulletins printed and distributed by the SAO. He furnished this money because of an interest in "survival." At one time he was shown a poster printed on 8 1/2" x 11" paper containing a restre of information extracted from newspapers regarding President NIXON. Later when this poster was printed and distributed, he was surprised to see that it was printed on 8 1/2" x 13" paper, contained a photograph of President NIXON and indicated that he was wanted.

RUFLENGER said his only interest in the SAO was the organization's contribution to "survival." He said he has always had an interest in this matter and has written many pamphlets over the years dealing with this subject. He was at one time a "Survival Consultant." His latest effort in the field of survival was to mastermind an organization called "Virtues in America." He said he had help in setting up the organization but that it failed because of lack of interest. The organization was only interested in pushing survival activity. He would like to reorganize this organization. If he is able to do so he will advise the FBI of his progress and will furnish copies of any literature distributed by him.

On 11/22/72 at San Diego, California File # 170-286A-223
357-3226
 by SAs DWIGHT G. CARLTON and
EARL H. PETERSON:emp Date dictated 11/27/72

He stated that he is acquainted with General WILLIAM LEMLY, 1536 Glorietta Place, Coronado, California. He met him in connection with an organization called the "Liberty Amendment Committee." This was a movement started by one WILLIS STONE to change or completely eliminate the 16th Amendment to the Constitution. This would eliminate the income tax in the United States. Another goal of the organization was to get the U. S. Government out of all the businesses it runs at a loss.

RUPLINGER stated that he has never been a member of the Minutemen Organization. He met TROY HAUGHTON, the leader of this group twice in 1965 or 1966. The first time he met HAUGHTON, he got into an argument with him when he told him that the Minutemen Organization was inconsistent. He denied knowing anything about the disappearance of HAUGHTON.

RUPLINGER stated that he is not involved in any activity against the best interest of the United States and does not intend to get involved in such activity. He said he does not have in his possession explosives or illegal weapons.

[Faded text, likely bleed-through from the reverse side of the page]

[Faded text, likely bleed-through from the reverse side of the page]

SAC, SAN DIEGO (157-2815)

7/13/73

SA DWIGHT G. GARRETSON

SECRET ARMY ORGANIZATION
EM

Review of pertinent files reveals the following information:

Information regarding shooting of PAULA THARP by GEORGE MITCHELL HOOVER was originally furnished by SA STEVEN LEE CHRISTENSEN by HOWARD BARRY GODFREY on 1/12/72. The shooting had occurred on 1/6/72. See memo of SA CHRISTENSEN dated 1/13/72 and San Diego Nitel to Bureau 1/13/73. (170-286-90 and 157-3017-20).

The information regarding this shooting was furnished to CAPTAIN KENNETH O'BRIEN, SDPD by SAs CHRISTENSEN and EARL M. PETERSEN on 1/13/73. See San Diego Nitel to Bureau 1/14/73. (170-286-88 and 157-3017-19).

2 - 157-2815
1 - 157-3017
① - 170-286

(4)
DGG:

170-281-A-225

SEARCHED	INDEXED
SERIALIZED	FILED
JUL 1 1973	
FBI-SAN DIEGO	